

2022

Over ten countries technic combination & innovation in metrology all made by Taiwan



METROLOGY®

台灣黑馬牌

TAIWAN NO.1 WORLD TOP10

Expert of precision  
Measurement Calibration Test

2D 2.5D  
Image measuring instrument



3D 5 AXIS  
Coordinate  
Measuring Machine



1D 2D  
Micro Height Gauge

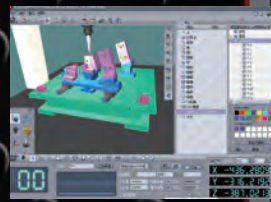
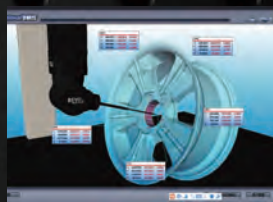
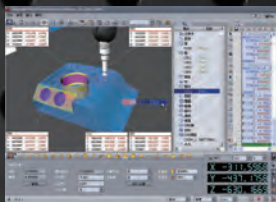

Metrology  
Technology Research & Development Co., Ltd.

www.metrology.com.tw

Jingstone@metrology.com.tw



# Solution36



## Metrology Technology Solution Center



Three display themes : Length measuring Calibration equipment Hardness testing equipment

Top 10 categories products : Caliper, Micrometer, Dial indicator, Measuring gauge, Granite master gauge, Optical microscope, Calibrator, Instrument, Hardness testing equipment, Non-destruction testing equipment

### Solution36

- 1 Provide teaching observation in academic circles such as high schools, universities, machinery-related subjects and research institutions
- 2 Provide training and observation of precision industry personnel and the formulation and implementation of technical support solutions
- 3 According to the requirements of ISO IEC 17025, provide instrument calibration, measurement and testing technical support services
- 4 Provide honest, professional, trustworthy and accurate calibration, measurement and test reports on behalf of clients as a third party notarized and credible



Jingstone precision group with kaohsiung innovative city  
Look to the future Navigate to the world



### Vernier Caliper

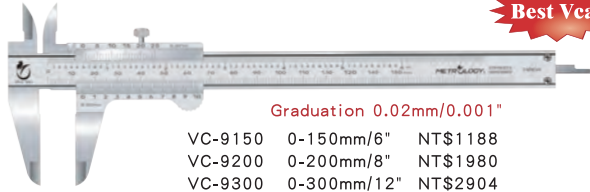

**Best Vcal**

Graduation 0.02mm/0.001"

VC-9150	0-150mm/6"	NT\$1188
VC-9200	0-200mm/8"	NT\$1980
VC-9300	0-300mm/12"	NT\$2904

### Dial Caliper

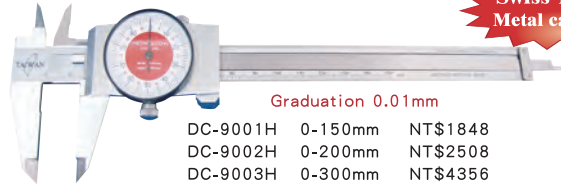

**Swiss Type Metal casing**

Graduation 0.01mm

DC-9001H	0-150mm	NT\$1848
DC-9002H	0-200mm	NT\$2508
DC-9003H	0-300mm	NT\$4356

### Dial Caliper



**Swiss Type Plastic casing**

Graduation 0.01mm

DC-9001HN	0-150mm	NT\$1848
DC-9002HN	0-200mm	NT\$2508
DC-9003HN	0-300mm	NT\$4356

### Digital Caliper NEW

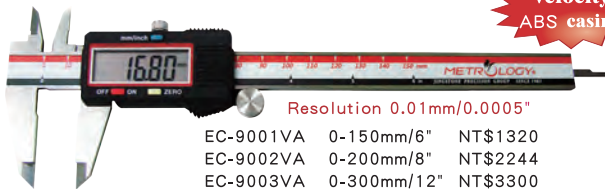

**Velocity ABS casing**

Resolution 0.01mm/0.0005"

EC-9001VA	0-150mm/6"	NT\$1320
EC-9002VA	0-200mm/8"	NT\$2244
EC-9003VA	0-300mm/12"	NT\$3300

### Digital Caliper



**5Micro IP54**

Resolution 0.005mm/0.0005"

EC-9001WH	0-150mm/6"	NT\$1980
EC-9002WH	0-200mm/8"	NT\$3168
EC-9003WH	0-300mm/12"	NT\$4356

### Digital Caliper

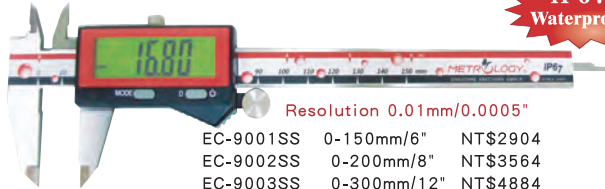

**IP67 Waterproof**

Resolution 0.01mm/0.0005"

EC-9001SS	0-150mm/6"	NT\$2904
EC-9002SS	0-200mm/8"	NT\$3564
EC-9003SS	0-300mm/12"	NT\$4884

### Digital Caliper NEW

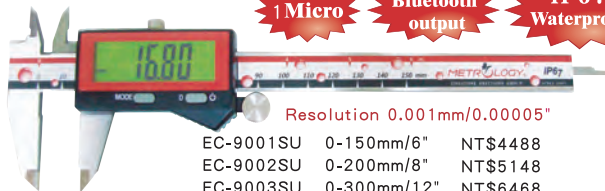

**1Micro Bluetooth output IP67 Waterproof**

Resolution 0.001mm/0.00005"

EC-9001SU	0-150mm/6"	NT\$4488
EC-9002SU	0-200mm/8"	NT\$5148
EC-9003SU	0-300mm/12"	NT\$6468

### Digital Caliper



Jaw thickness is 0.75mm **Blade**

Resolution 0.01mm/0.0005"

EC-9001BL	0-150mm/6"	NT\$3828
EC-9002BL	0-200mm/8"	NT\$5412
EC-9003BL	0-300mm/12"	NT\$8052

### Depth Base

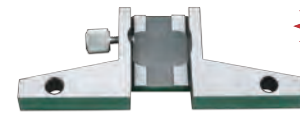

**Caliper use**

Measuring Face 80\*7.5mm

CB-BASE1	Suitable range 0-200mm	Scale Width 16mm	NT\$792
CB-BASE2	Suitable range 0-300mm	Scale Width 17mm	NT\$792

### Dial Caliper



**Carbide I&O jaw Swiss Type Metal casing**

Graduation 0.01mm

DC-9001HT	0-150mm	NT\$4752
DC-9002HT	0-200mm	NT\$6072
DC-9003HT	0-300mm	NT\$7656

### Digital Caliper



**Fraction IP54**

Resolution 0.01mm/0.0005"

EC-9001WF	0-150mm/6"	NT\$1848
EC-9002WF	0-200mm/8"	NT\$2904
EC-9003WF	0-300mm/12"	NT\$4092

### Digital Caliper

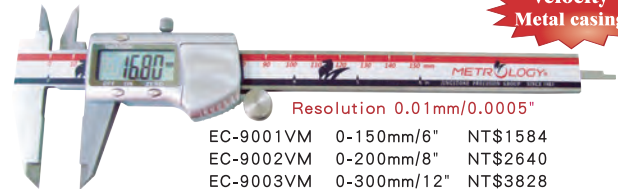

**Velocity Metal casing**

Resolution 0.01mm/0.0005"

EC-9001VM	0-150mm/6"	NT\$1584
EC-9002VM	0-200mm/8"	NT\$2640
EC-9003VM	0-300mm/12"	NT\$3828

### Digital Caliper



**Data output ABS IP54**

Resolution 0.01mm/0.0005"

EC-9001AB	0-150mm/6"	NT\$1980
EC-9002AB	0-200mm/8"	NT\$3168
EC-9003AB	0-300mm/12"	NT\$4356

### Digital Caliper



**Bluetooth output IP67 Waterproof**

Resolution 0.01mm/0.0005"

EC-9001SB	0-150mm/6"	NT\$3696
EC-9002SB	0-200mm/8"	NT\$4356
EC-9003SB	0-300mm/12"	NT\$5676

### Digital Caliper

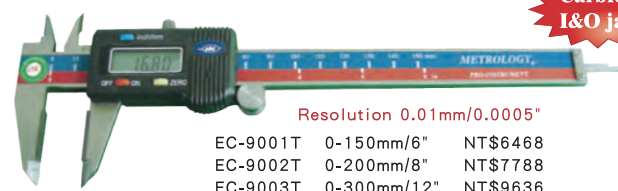

**Carbide I&O jaw**

Resolution 0.01mm/0.0005"

EC-9001T	0-150mm/6"	NT\$6468
EC-9002T	0-200mm/8"	NT\$7788
EC-9003T	0-300mm/12"	NT\$9636

### Digital Caliper



**Point**

Resolution 0.01mm/0.0005"

EC-9001PT	0-150mm/6"	NT\$3432
EC-9002PT	0-200mm/8"	NT\$4224
EC-9003PT	0-300mm/12"	NT\$6864



### Digital Caliper

**Outside Groove**



Resolution 0.01mm/0.0005"  
 EC-9001OG 0-150mm/6" NT\$4884  
 EC-9002OG 0-200mm/8" NT\$6864  
 EC-9003OG 0-300mm/12" NT\$13068  
 EC-9004OG 0-500mm/20" NT\$20592

### Digital Caliper

**Inside Groove**

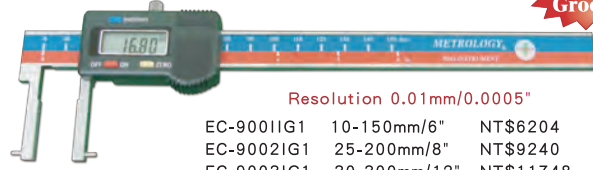

Resolution 0.01mm/0.0005"  
 EC-9001IG1 10-150mm/6" NT\$6204  
 EC-9002IG1 25-200mm/8" NT\$9240  
 EC-9003IG1 30-300mm/12" NT\$11748  
 EC-9004IG1 40-500mm/20" NT\$15972

### Digital Caliper Diagram for reference

**Inside&Outside Interchangeable Anvil**

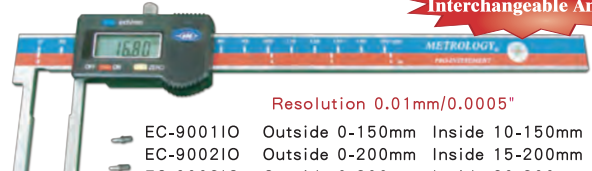

Resolution 0.01mm/0.0005"  
 EC-9001IO Outside 0-150mm Inside 10-150mm NT\$  
 EC-9002IO Outside 0-200mm Inside 15-200mm NT\$  
 EC-9003IO Outside 0-300mm Inside 20-300mm NT\$  
 EC-9004IO Outside 0-500mm Inside 30-500mm NT\$

### Digital Caliper

**Center Distance**

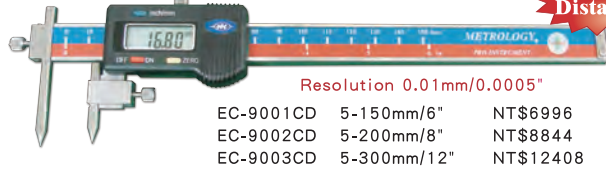

Resolution 0.01mm/0.0005"  
 EC-9001CD 5-150mm/6" NT\$6996  
 EC-9002CD 5-200mm/8" NT\$8844  
 EC-9003CD 5-300mm/12" NT\$12408  
 EC-9004CD 5-500mm/20" NT\$22044  
 EC-9005CD 10-1000mm/40" NT\$41976

### Digital Caliper

**Tube**

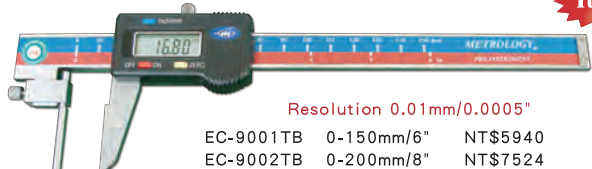

Resolution 0.01mm/0.0005"  
 EC-9001TB 0-150mm/6" NT\$5940  
 EC-9002TB 0-200mm/8" NT\$7524  
 EC-9003TB 0-300mm/12" NT\$9504

### Digital Caliper Measuring Jaw(Optional)



**Screw**

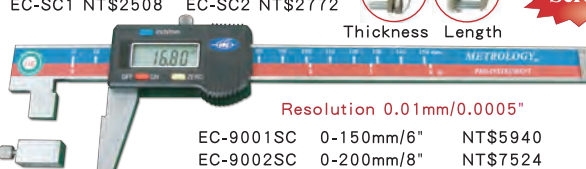

EC-SC1 NT\$2508 EC-SC2 NT\$2772  
 Thickness Length  
 Resolution 0.01mm/0.0005"  
 EC-9001SC 0-150mm/6" NT\$5940  
 EC-9002SC 0-200mm/8" NT\$7524  
 EC-9003SC 0-300mm/12" NT\$9504

### Digital Caliper

**Depth**

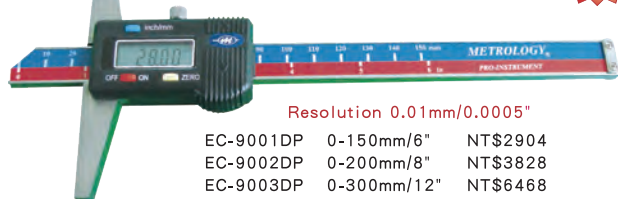

Resolution 0.01mm/0.0005"  
 EC-9001DP 0-150mm/6" NT\$2904  
 EC-9002DP 0-200mm/8" NT\$3828  
 EC-9003DP 0-300mm/12" NT\$6468  
 EC-9004DP 0-500mm/20" NT\$13068  
 EC-9005DP 0-800mm/30" NT\$23760  
 EC-9006DP 0-1000mm/40" NT\$40656

### Digital Caliper

**Offset**

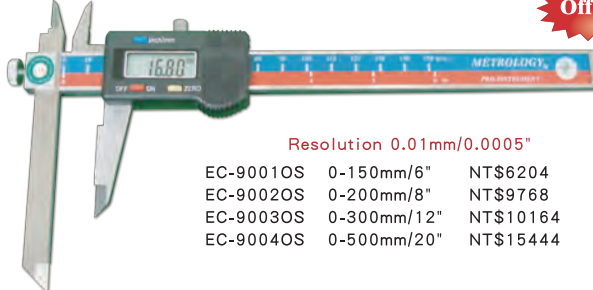

Resolution 0.01mm/0.0005"  
 EC-9001OS 0-150mm/6" NT\$6204  
 EC-9002OS 0-200mm/8" NT\$9768  
 EC-9003OS 0-300mm/12" NT\$10164  
 EC-9004OS 0-500mm/20" NT\$15444

### Digital Caliper

**Outside Arc Radius**

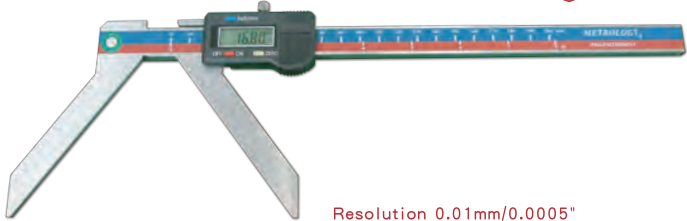

Resolution 0.01mm/0.0005"  
 EC-9001OR R3-150mm/6" NT\$8184  
 EC-9002OR R3-200mm/8" NT\$10164

### Digital Caliper

**Disc**

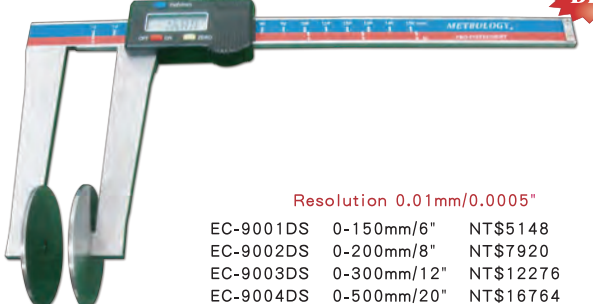

Resolution 0.01mm/0.0005"  
 EC-9001DS 0-150mm/6" NT\$5148  
 EC-9002DS 0-200mm/8" NT\$7920  
 EC-9003DS 0-300mm/12" NT\$12276  
 EC-9004DS 0-500mm/20" NT\$16764

**Digital**

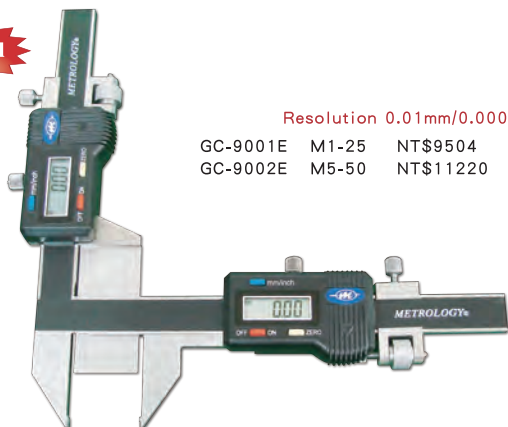

Resolution 0.01mm/0.0005"  
 GC-9001E M1-25 NT\$9504  
 GC-9002E M5-50 NT\$11220

### Gear Tooth Caliper

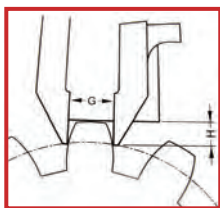
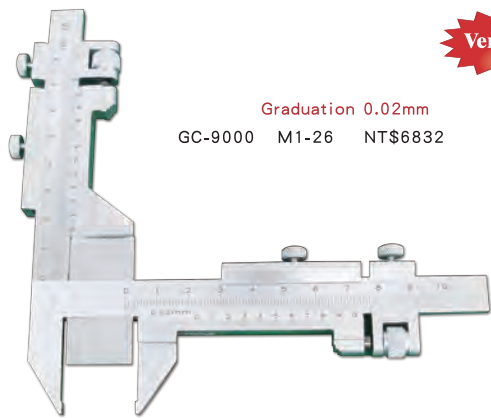

Diagram of measurement



**Vernier**

Graduation 0.02mm  
 GC-9000 M1-26 NT\$6832



### Digital Caliper

**Groove Width**



Resolution 0.01mm/0.0005"

EC-9001GW	3-150mm/6"	NT\$6996
EC-9002GW	3-200mm/8"	NT\$8712
EC-9003GW	4-300mm/12"	NT\$10428

### Digital Outside Snap Gauge



Resolution 0.01mm/0.0005"

ES-9001	0-12.5mm/0.5"	NT\$4360
---------	---------------	----------

### Digital 3-way Gauge



1. Outside & groove diameter measuring anvil.
2. Outside length & thickness measuring jaws.
3. Inside measuring jaws.

Resolution 0.01mm/0.0005"

ES-9000TU	0-25mm/1"	NT\$4360
-----------	-----------	----------

### Digital Single Wide Face Gauge



Resolution 0.01mm/0.0005"

ES-9000SW	0-30mm/1.2"	NT\$4360
-----------	-------------	----------

### Large Jaw Digital Caliper

**Standard Jaw**

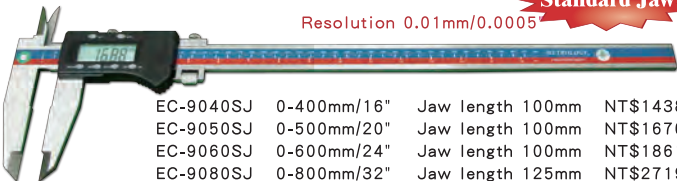

Resolution 0.01mm/0.0005"

EC-9040SJ	0-400mm/16"	Jaw length 100mm	NT\$14388
EC-9050SJ	0-500mm/20"	Jaw length 100mm	NT\$16764
EC-9060SJ	0-600mm/24"	Jaw length 100mm	NT\$18612
EC-9080SJ	0-800mm/32"	Jaw length 125mm	NT\$27192
EC-9100SJ	0-1000mm/40"	Jaw length 150mm	NT\$39864

### Large Jaw Digital Caliper

**Single Long Jaw**

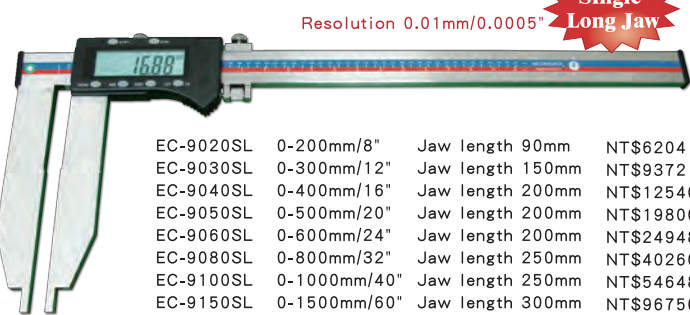

Resolution 0.01mm/0.0005"

EC-9020SL	0-200mm/8"	Jaw length 90mm	NT\$6204
EC-9030SL	0-300mm/12"	Jaw length 150mm	NT\$9372
EC-9040SL	0-400mm/16"	Jaw length 200mm	NT\$12540
EC-9050SL	0-500mm/20"	Jaw length 200mm	NT\$19800
EC-9060SL	0-600mm/24"	Jaw length 200mm	NT\$24948
EC-9080SL	0-800mm/32"	Jaw length 250mm	NT\$40260
EC-9100SL	0-1000mm/40"	Jaw length 250mm	NT\$54648
EC-9150SL	0-1500mm/60"	Jaw length 300mm	NT\$96756
EC-9200SL	0-2000mm/80"	Jaw length 300mm	NT\$138732

### Digital Scale

Resolution 0.01mm/0.0005" **Horizontal**



ES-9010H	0-100mm	NT\$2112	ES-9060H	0-600mm	NT\$11352
ES-9015H	0-150mm	NT\$2640	ES-9070H	0-700mm	NT\$13992
ES-9020H	0-200mm	NT\$3432	ES-9080H	0-800mm	NT\$16896
ES-9030H	0-300mm	NT\$5016	ES-9100H	0-1000mm	NT\$23496
ES-9040H	0-400mm	NT\$7392	ES-9150H	0-1500mm	NT\$52404
ES-9050H	0-500mm	NT\$10296	ES-9200H	0-2000mm	NT\$60324

### Vernier Caliper

**Parallel Scribing**



Graduation 0.1mm / 1/128"

VC-9200S	0-200mm/8"	NT\$3168
----------	------------	----------

### Digital Outside Snap Gauge



Resolution 0.01mm/0.0005"

ES-9002	0-25mm/1"	NT\$6273
---------	-----------	----------

### Digital Welding Gauge



Resolution 0.01mm/0.0005"

ES-9000WD	0-12.5mm/0.5"	NT\$4170
-----------	---------------	----------

### Digital Depth Gauge



Resolution 0.01mm/0.0005"

ES-9000DP(Plastic base)	0-25mm/1"	NT\$1749
ES-9000DS(Steel base)	0-25mm/1"	NT\$3530
ES-EB150(Steel extension base)	L:150mm	NT\$1320

### Large Jaw Digital Caliper

**Double Inside Jaw**

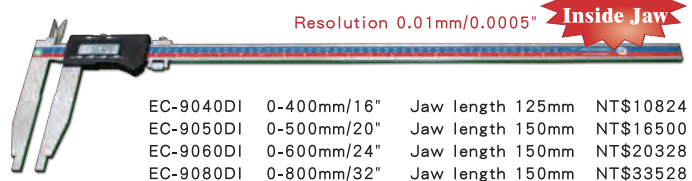

Resolution 0.01mm/0.0005"

EC-9040DI	0-400mm/16"	Jaw length 125mm	NT\$10824
EC-9050DI	0-500mm/20"	Jaw length 150mm	NT\$16500
EC-9060DI	0-600mm/24"	Jaw length 150mm	NT\$20328
EC-9080DI	0-800mm/32"	Jaw length 150mm	NT\$33528
EC-9100DI	0-1000mm/40"	Jaw length 200mm	NT\$39468

### Large Jaw Digital Caliper

**Double Outside Jaw**

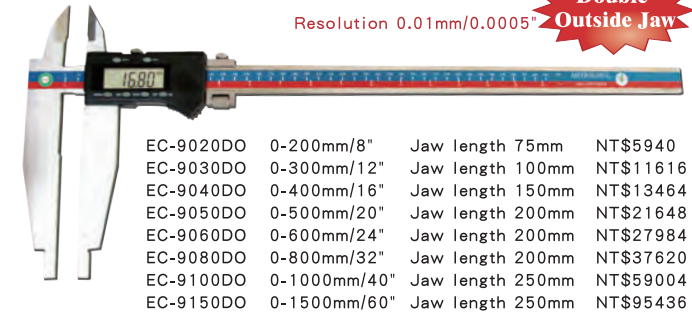

Resolution 0.01mm/0.0005"

EC-9020DO	0-200mm/8"	Jaw length 75mm	NT\$5940
EC-9030DO	0-300mm/12"	Jaw length 100mm	NT\$11616
EC-9040DO	0-400mm/16"	Jaw length 150mm	NT\$13464
EC-9050DO	0-500mm/20"	Jaw length 200mm	NT\$21648
EC-9060DO	0-600mm/24"	Jaw length 200mm	NT\$27984
EC-9080DO	0-800mm/32"	Jaw length 200mm	NT\$37620
EC-9100DO	0-1000mm/40"	Jaw length 250mm	NT\$59004
EC-9150DO	0-1500mm/60"	Jaw length 250mm	NT\$95436
EC-9200DO	0-2000mm/80"	Jaw length 250mm	NT\$141372

### Digital Scale

Resolution 0.01mm/0.0005" **Vertical**



ES-9010V	0-100mm	NT\$3300	ES-9060V	0-600mm	NT\$12408
ES-9015V	0-150mm	NT\$3696	ES-9070V	0-700mm	NT\$15048
ES-9020V	0-200mm	NT\$4752	ES-9080V	0-800mm	NT\$17952
ES-9030V	0-300mm	NT\$6072	ES-9100V	0-1000mm	NT\$24864
ES-9040V	0-400mm	NT\$8052	ES-9150V	0-1500mm	NT\$44088
ES-9050V	0-500mm	NT\$10692	ES-9200V	0-2000mm	NT\$61380



# SPECIAL MEASURING JAWS

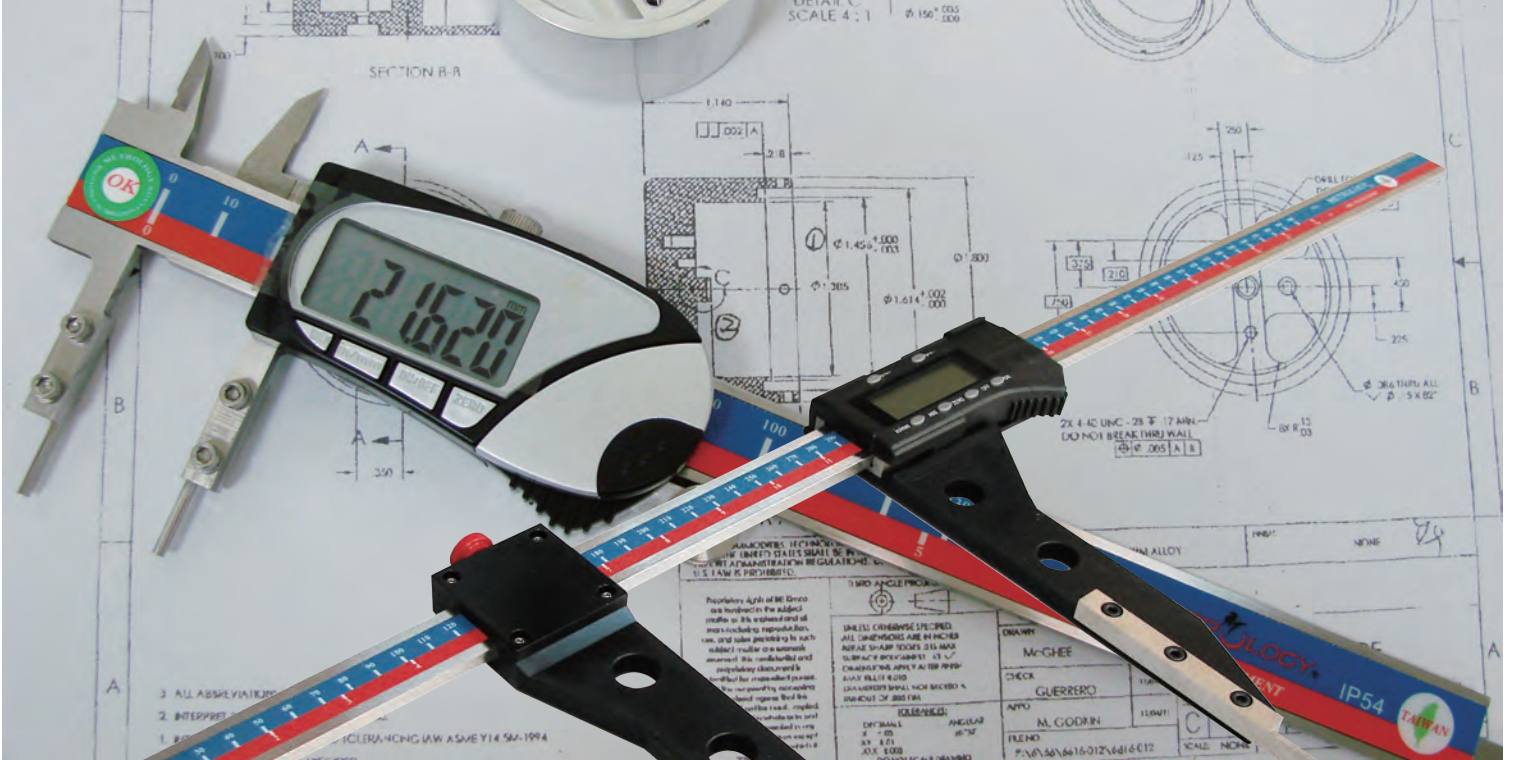

Data output link  
DO-B+C04 NT\$3036



Bluetooth wireless data transmitter  
DO-W2-RS NT\$1716

Long jaw



Universal jaw

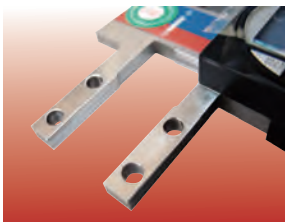

Double face jaw

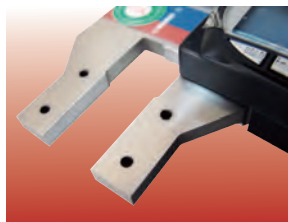

Step jaw



Multiplex jaw



Center jaw



Point jaw

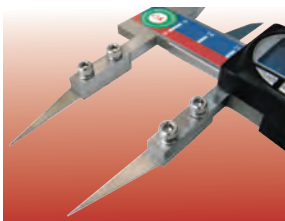

Internal gear/internal thread



External gear/External thread



Inside jaw



\*The measuring jaw can be customized according to design drawing or measurement item of workpiece to suit your particular requirements.



### Digital Outside Micrometer



**Standard**

Resolution 0.001mm/0.00005"  
 EM-9001 0-25mm/0-1" NT\$2112  
 EM-9002 25-50mm/1"-2" NT\$2640  
 EM-9003 50-75mm/2"-3" NT\$3168  
 EM-9004 75-100mm/3"-4" NT\$3696  
 ≥ 25mm with standard bar

### Digital Outside Micrometer



**IP65 Waterproof**

Data output link DO-B+C01 NT\$3036  
 Bluetooth wireless data transmitter DO-W2-RS1 NT\$1716  
 Resolution 0.001mm/0.00005"  
 EM-9001SF 0-25mm/0-1" NT\$3564  
 EM-9002SF 25-50mm/1"-2" NT\$4224  
 EM-9003SF 50-75mm/2"-3" NT\$4752  
 EM-9004SF 75-100mm/3"-4" NT\$5280  
 ≥ 25mm with standard bar

### Digital Outside Micrometer



**IP65 Fast**

**2mm per revolution**

Resolution 0.001mm/0.00005"  
 EM-9001WF 0-25mm/0-1" NT\$6600  
 EM-9002WF 25-50mm/1"-2" NT\$7392  
 EM-9003WF 50-75mm/2"-3" NT\$8184  
 EM-9004WF 75-100mm/3"-4" NT\$8976  
 ≥ 25mm with standard bar

### Digital Outside Micrometer



**IP65 Second**

Non-rotating pull rod  
 Data output link DO-B+C01 NT\$3036  
 Bluetooth transmitter DO-W2-RS1 NT\$1716

Resolution 0.001mm/0.00005"  
 EM-9001S 0-25mm/0-1" NT\$5808  
 EM-9002S 25-50mm/1"-2" NT\$6600  
 EM-9003S 50-75mm/2"-3" NT\$7524  
 EM-9004S 75-100mm/3"-4" NT\$8316  
 ≥ 25mm with standard bar

### Outside Micrometer



**Standard**

Graduation 0.01mm  
 OM-9001 0-25mm NT\$1188  
 OM-9002 25-50mm NT\$1320  
 OM-9003 50-75mm NT\$1452  
 OM-9004 75-100mm NT\$1584  
 OM-9013(set) 0-75mm NT\$4884  
 OM-9014(set) 0-100mm NT\$6732  
 ≥ 25mm with standard bar

### Outside Micrometer



**Mechanical Digits**

Graduation 0.01mm  
 OM-9042 0-25mm NT\$2772  
 OM-9043 25-50mm NT\$3168  
 OM-9044 50-75mm NT\$4356  
 OM-9045 75-100mm NT\$4752  
 OM-9046 100-125mm NT\$5676  
 OM-9047 125-150mm NT\$6468  
 OM-9048 150-175mm NT\$7788  
 OM-9049 175-200mm NT\$8712  
 ≥ 25mm with standard bar

### Outside Micrometer



**1 Micro Parallax Free**

Graduation 0.001mm  
 OM-9034H 0-25mm NT\$3960  
 OM-9035H 25-50mm NT\$4224  
 OM-9036H 50-75mm NT\$4620  
 OM-9037H 75-100mm NT\$4884  
 OM-9038H 100-125mm NT\$5676  
 OM-9039H 125-150mm NT\$6336  
 OM-9040H 150-175mm NT\$6600  
 OM-9041H 175-200mm NT\$7260  
 ≥ 25mm with standard bar

### Outside Micrometer



**1 Micro**

Graduation 0.001mm  
 OM-9018H 0-25mm NT\$1188  
 OM-9019H 25-50mm NT\$1320  
 OM-9020H 50-75mm NT\$1452  
 OM-9021H 75-100mm NT\$1716  
 Heat insulating plastic frame cover  
 OM-9022H 0-25mm NT\$1188  
 OM-9023H 25-50mm NT\$1320  
 OM-9024H 50-75mm NT\$1452  
 OM-9025H 75-100mm NT\$1716  
 Painted cast iron frame  
 ≥ 25mm with standard bar

### Outside Micrometer



OM-9005

**Standard**

Graduation 0.01mm

OM-9005 100-125mm NT\$2244	OM-9011 250-275mm NT\$4224
OM-9006 125-150mm NT\$2508	OM-9012 275-300mm NT\$4488
OM-9007 150-175mm NT\$2904	OM-9015(set) 0-150mm NT\$11352
OM-9008 175-200mm NT\$3168	OM-9016(set) 150-300mm NT\$21912
OM-9009 200-225mm NT\$3564	OM-9017(set) 0-300mm NT\$33264
OM-9010 225-250mm NT\$3828	with standard bar



Data output link



Bluetooth wireless data transmitter

### Outside Micrometer



**100 Step Graduation**

**1mm per revolution**

Graduation 0.01mm Φ8mm measuring spindle  
 OM-9026 0-25mm NT\$3795  
 OM-9027 25-50mm NT\$4356  
 OM-9028 50-75mm NT\$5676  
 OM-9029 75-100mm NT\$6204  
 ≥ 25mm with standard bar

**Outside Micrometer**



**Interchangeable Anvil**

OM-9056

Graduation 0.01mm

OM-9054	0-150mm	NT\$8052	OM-9057	100-200mm	NT\$9108
OM-9055	150-300mm	NT\$10164	OM-9058	200-300mm	NT\$9768
OM-9056	0-100mm	NT\$6336			

**Digital Outside Micrometer**



**Interchangeable Anvil**

EM-9056

Resolution 0.001mm/0.00005"

EM-9054	0-150mm/0-6"	NT\$9636	EM-9057	100-200mm/4"-8"	NT\$11748
EM-9055	150-300mm/6"-12"	NT\$10824	EM-9058	200-300mm/8"-12"	NT\$12936
EM-9056	0-100mm/0-4"	NT\$8712			

**Outside Micrometer**



**Interchangeable Anvil**

Graduation 0.01mm

OM-9059	300-400mm	NT\$19140	OM-9065	900-1000mm	NT\$45276
OM-9060	400-500mm	NT\$21648	OM-9066	1000-1200mm	NT\$68244
OM-9061	500-600mm	NT\$24816	OM-9067	1200-1400mm	NT\$72996
OM-9062	600-700mm	NT\$29832	OM-9068	1400-1600mm	NT\$81180
OM-9063	700-800mm	NT\$34848	OM-9069	1600-1800mm	NT\$86196
OM-9064	800-900mm	NT\$39600	OM-9070	1800-2000mm	NT\$91212

**Outside Micrometer**

**Mini**

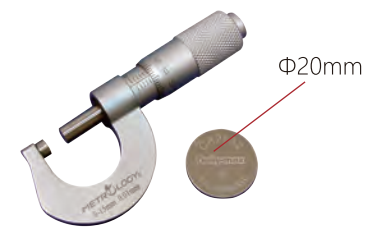

Φ20mm

Graduation 0.01mm

OM-9215	0-15mm	NT\$1584
---------	--------	----------

**Digital**

Resolution 0.001mm/0.00005"

EM-9059	300-400mm	NT\$15180	EM-9063	700-800mm	NT\$24552
EM-9060	400-500mm	NT\$16632	EM-9064	800-900mm	NT\$27456
EM-9061	500-600mm	NT\$18612	EM-9065	900-1000mm	NT\$30096
EM-9062	600-700mm	NT\$21252			

**Outside Micrometer**



**Small Face**

Graduation 0.01mm

Tungsten steel measuring tip Φ2\*L5mm

OM-9071	0-25mm	NT\$2812
OM-9072	25-50mm	NT\$3036
OM-9073	50-75mm	NT\$4092
OM-9074	75-100mm	NT\$4884
OM-9075	100-125mm	NT\$5808
OM-9076	125-150mm	NT\$6996
OM-9077	150-175mm	NT\$8448

Tungsten steel measuring tip Φ3\*L10mm

OM-9078	0-25mm	NT\$2772
OM-9079	25-50mm	NT\$3036
OM-9080	50-75mm	NT\$4092
OM-9081	75-100mm	NT\$4884
OM-9082	100-125mm	NT\$5808
OM-9083	125-150mm	NT\$6996
OM-9084	150-175mm	NT\$8448

**Digital Outside Micrometer**



**Small Face**

Resolution 0.001mm/0.00005"

Tungsten steel measuring tip Φ2\*L5mm

EM-9071	0-25mm	NT\$7260
EM-9072	25-50mm	NT\$7788
EM-9073	50-75mm	NT\$10296
EM-9074	75-100mm	NT\$10824
EM-9075	100-125mm	NT\$11484
EM-9076	125-150mm	NT\$11880
EM-9077	150-175mm	NT\$12540

Tungsten steel measuring tip Φ3\*L10mm

EM-9078	0-25mm	NT\$7260
EM-9079	25-50mm	NT\$7788
EM-9080	50-75mm	NT\$10296
EM-9081	75-100mm	NT\$10824
EM-9082	100-125mm	NT\$11484
EM-9083	125-150mm	NT\$11880
EM-9084	150-175mm	NT\$12540



### Outside Micrometer



Graduation 0.01mm

**Tungsten steel Tip angle 30° R0.3mm**

OM-9085	0-25mm	NT\$2772
OM-9086	25-50mm	NT\$3036
OM-9087	50-75mm	NT\$4092
OM-9088	75-100mm	NT\$4884

**Tungsten steel Tip angle 15° R0.3mm**

OM-9089	0-25mm	NT\$2772
OM-9090	25-50mm	NT\$3036
OM-9091	50-75mm	NT\$4092
OM-9092	75-100mm	NT\$4884

### Digital Outside Micrometer



Resolution 0.001mm/0.00005"

**Tungsten steel Tip angle 30° R0.3mm**

EM-9085	0-25mm	NT\$7211
EM-9086	25-50mm	NT\$7700
EM-9087	50-75mm	NT\$10296
EM-9088	75-100mm	NT\$10956

**Tungsten steel Tip angle 15° R0.3mm**

EM-9089	0-25mm	NT\$7211
EM-9090	25-50mm	NT\$7700
EM-9091	50-75mm	NT\$10296
EM-9092	75-100mm	NT\$10956

### Outside Micrometer



Graduation 0.01mm

**Steel disc Φ20mm Non-rotating Spindle**

OM-9093	0-25mm	NT\$6072
OM-9094	25-50mm	NT\$6600
OM-9095	50-75mm	NT\$8844
OM-9096	75-100mm	NT\$9372

**Steel disc Φ30mm Non-rotating Spindle**

OM-9097	0-25mm	NT\$10032
OM-9098	25-50mm	NT\$10824
OM-9099	50-75mm	NT\$11616
OM-9100	75-100mm	NT\$12276

### Digital Outside Micrometer



Resolution 0.001mm/0.00005"

**Steel disc Φ20mm Non-rotating Spindle**

EM-9093	0-25mm	NT\$8052
EM-9094	25-50mm	NT\$8712
EM-9095	50-75mm	NT\$11748
EM-9096	75-100mm	NT\$12936

**Steel disc Φ30mm Non-rotating Spindle**

EM-9097	0-25mm	NT\$13992
EM-9098	25-50mm	NT\$15312
EM-9099	50-75mm	NT\$16632
EM-9100	75-100mm	NT\$17952

### Outside Micrometer



Graduation 0.01mm

**Tungsten steel measuring anvils Non-rotating Spindle**

OM-9101	0-25mm	NT\$7128
OM-9102	25-50mm	NT\$7656
OM-9103	50-75mm	NT\$10296
OM-9104	75-100mm	NT\$11352
OM-9105	100-125mm	NT\$12276
OM-9106	125-150mm	NT\$13332
OM-9107	150-175mm	NT\$14520
OM-9108	175-200mm	NT\$15576

### Digital Outside Micrometer



Resolution 0.001mm/0.00005"

**Tungsten steel measuring anvils Non-rotating Spindle**

EM-9101	0-25mm	NT\$8052
EM-9102	25-50mm	NT\$8712
EM-9103	50-75mm	NT\$11748
EM-9104	75-100mm	NT\$12936
EM-9105	100-125mm	NT\$13992
EM-9106	125-150mm	NT\$15312
EM-9107	150-175mm	NT\$16632
EM-9108	175-200mm	NT\$17952

### Outside Micrometer



Graduation 0.01mm

**Hardened steel T0.75\*L6.5mm Non-rotating Spindle**

OM-9109	0-25mm	NT\$5808
OM-9110	25-50mm	NT\$6336
OM-9111	50-75mm	NT\$8448
OM-9112	75-100mm	NT\$9240
OM-9113	100-125mm	NT\$10164
OM-9114	125-150mm	NT\$10956
OM-9115	150-175mm	NT\$12012

**Hardened steel T0.4\*L3.5mm Non-rotating Spindle**

OM-9109S	0-25mm	NT\$6996
OM-9110S	25-50mm	NT\$7524
OM-9111S	50-75mm	NT\$10164
OM-9112S	75-100mm	NT\$11088
OM-9113S	100-125mm	NT\$12144
OM-9114S	125-150mm	NT\$13200
OM-9115S	150-175mm	NT\$14388

### Digital Outside Micrometer



Resolution 0.001mm/0.00005"

**Hardened steel T0.75\*L6.5mm Non-rotating Spindle**

EM-9109	0-25mm	NT\$8184
EM-9110	25-50mm	NT\$8712
EM-9111	50-75mm	NT\$11484
EM-9112	75-100mm	NT\$12276
EM-9113	100-125mm	NT\$12936
EM-9114	125-150mm	NT\$13596
EM-9115	150-175mm	NT\$14124

**Hardened steel T0.4\*L3.5mm Non-rotating Spindle**

EM-9109S	0-25mm	NT\$8976
EM-9110S	25-50mm	NT\$9636
EM-9111S	50-75mm	NT\$12672
EM-9112S	75-100mm	NT\$13596
EM-9113S	100-125mm	NT\$14388
EM-9114S	125-150mm	NT\$15048
EM-9115S	150-175mm	NT\$15840

## Outside Micrometer



**Universal**

Graduation 0.01mm Non-rotating Spindle

OM-9116	0-25mm	NT\$9636
OM-9117	25-50mm	NT\$10032
OM-9118	50-75mm	NT\$13068
OM-9119	75-100mm	NT\$13992
OM-9120	100-125mm	NT\$14784
OM-9121	125-150mm	NT\$15576
OM-9122	150-175mm	NT\$16368
OM-9123	175-200mm	NT\$17292

Include set AV-9008, 7 interchangeable measuring anvils.

## Digital Outside Micrometer



**Universal**

Resolution 0.001mm/0.00005"  
Non-rotating Spindle

EM-9116	0-25mm	NT\$11352
EM-9117	25-50mm	NT\$11616
EM-9118	50-75mm	NT\$14916
EM-9119	75-100mm	NT\$15576
EM-9120	100-125mm	NT\$16236
EM-9121	125-150mm	NT\$17028
EM-9122	150-175mm	NT\$17820
EM-9123	175-200mm	NT\$18480

Include set AV-9008, 7 interchangeable measuring anvils.

## Outside Micrometer



**Tube**

OM-9128C

Graduation 0.01mm

OM-9124A	0-25mm	NT\$2244
OM-9125A	25-50mm	NT\$2640
OM-9126B	0-25mm	NT\$2244
OM-9127B	25-50mm	NT\$2640
OM-9128C	0-25mm	NT\$2244
OM-9129C	25-50mm	NT\$2640
OM-9130D	0-25mm	NT\$2244
OM-9131D	25-50mm	NT\$2640
OM-9132E	0-25mm	NT\$2244
OM-9133E	25-50mm	NT\$2640
OM-9134F	0-25mm	NT\$2244
OM-9135F	25-50mm	NT\$2640
OM-9136J	0-25mm	NT\$1848
OM-9137J	25-50mm	NT\$2244
OM-9138K	0-25mm	NT\$1848
OM-9139K	25-50mm	NT\$2244
OM-9140K	50-75mm	NT\$2696
OM-9141K	75-100mm	NT\$4356

## Digital Outside Micrometer



**Tube**

EM-9124A

Resolution 0.001mm/0.00005"

EM-9124A	0-25mm	NT\$8844
EM-9125A	25-50mm	NT\$9636
EM-9126B	0-25mm	NT\$8844
EM-9127B	25-50mm	NT\$9636
EM-9128C	0-25mm	NT\$8844
EM-9129C	25-50mm	NT\$9636
EM-9130D	0-25mm	NT\$8844
EM-9131D	25-50mm	NT\$9636
EM-9132E	0-25	NT\$8844
EM-9133E	25-50mm	NT\$9636
EM-9134F	0-25mm	NT\$8844
EM-9135F	25-50mm	NT\$9636
EM-9136J	0-25mm	NT\$7920
EM-9137J	25-50mm	NT\$8812
EM-9138K	0-25mm	NT\$7920
EM-9139K	25-50mm	NT\$8712
EM-9140K	50-75mm	NT\$9636
EM-9141K	75-100mm	NT\$10560

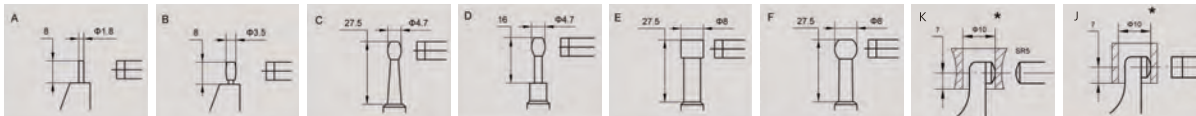

## Outside Micrometer



**V-Anvil**

Graduation 0.01mm

Tungsten steel 3Flute 60°

OM-9142	1-15mm	NT\$6864
OM-9143	5-20mm	NT\$7260
OM-9144	20-35mm	NT\$10692
OM-9145	35-50mm	NT\$13200
OM-9146	50-65mm	NT\$14124
OM-9147	65-80mm	NT\$15312
OM-9148	80-95mm	NT\$16500

Tungsten steel 5Flute 108°

OM-9149	2.3-25mm	NT\$11352
OM-9150	25-50mm	NT\$14256
OM-9151	5-25mm	NT\$8844
OM-9152	25-45mm	NT\$11484
OM-9153	45-65mm	NT\$13200
OM-9154	65-85mm	NT\$15312
OM-9155	85-105mm	NT\$17688

Tungsten steel 7Flute 128°34'17"

OM-9156	5-25mm	NT\$7128
OM-9157	25-45mm	NT\$11484
OM-9158	45-65mm	NT\$13200
OM-9159	65-85mm	NT\$15312

## Digital Outside Micrometer



**V-Anvil**

Resolution 0.001mm/0.00005"

Tungsten steel 3Flute 60°

EM-9142	1-15mm	NT\$10032
EM-9143	5-20mm	NT\$10164
EM-9144	20-35mm	NT\$13860
EM-9145	35-50mm	NT\$15708
EM-9146	50-65mm	NT\$15840
EM-9147	65-80mm	NT\$16632
EM-9148	80-95mm	NT\$17556

Tungsten steel 5Flute 108°

EM-9149	2.3-25mm	NT\$13068
EM-9150	25-50mm	NT\$15048
EM-9151	5-25mm	NT\$12672
EM-9152	25-45mm	NT\$14388
EM-9153	45-65mm	NT\$15576
EM-9154	65-85mm	NT\$17160
EM-9155	85-105mm	NT\$18480

Tungsten steel 7Flute 128°34'17"

EM-9156	5-25mm	NT\$10164
EM-9157	25-45mm	NT\$14388
EM-9158	45-65mm	NT\$15576
EM-9159	65-85mm	NT\$17160

## Outside Micrometer



**Screw Thread**

Graduation 0.01mm  
Non-rotating Spindle

OM-9160	0-25mm	NT\$3828
OM-9161	25-50mm	NT\$4092
OM-9162	50-75mm	NT\$6072
OM-9163	75-100mm	NT\$6600
OM-9164	100-125mm	NT\$7524
OM-9165	125-150mm	NT\$8448
OM-9166	150-175mm	NT\$9240
OM-9167	175-200mm	NT\$10296

Screw Thread Anvil(Optional)

## Digital Outside Micrometer



**Screw Thread**

Resolution 0.001mm/0.00005"  
Non-rotating Spindle

EM-9160	0-25mm	NT\$5940
EM-9161	25-50mm	NT\$6336
EM-9162	50-75mm	NT\$8580
EM-9163	75-100mm	NT\$9372
EM-9164	100-125mm	NT\$13728
EM-9165	125-150mm	NT\$14916
EM-9166	150-175mm	NT\$16368
EM-9167	175-200mm	NT\$17820

Screw Thread Anvil(Optional)



### Outside Micrometer



**Gear Root Diameter**

Graduation 0.01mm  
Carbide measuring tips

OM-9168	5-100mm	NT\$9768
OM-9169	100-200mm	NT\$13200
OM-9170	200-300mm	NT\$16236
OM-9171	300-400mm	NT\$19404
OM-9172	400-500mm	NT\$22440
OM-9173	500-600mm	NT\$26268
OM-9174	600-700mm	NT\$30360
OM-9175	700-800mm	NT\$34188
OM-9176	800-900mm	NT\$38280

### Digital Outside Micrometer

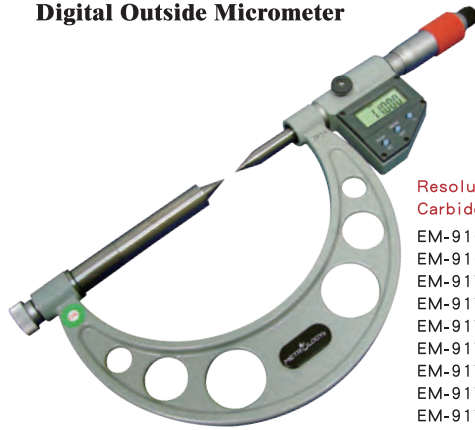

**Gear Root Diameter**

Resolution 0.001mm/0.00005"  
Carbide measuring tips

EM-9168	5-100mm	NT\$12276
EM-9169	100-200mm	NT\$14388
EM-9170	200-300mm	NT\$16236
EM-9171	300-400mm	NT\$18084
EM-9172	400-500mm	NT\$19800
EM-9173	500-600mm	NT\$22044
EM-9174	600-700mm	NT\$24552
EM-9175	700-800mm	NT\$26796
EM-9176	800-900mm	NT\$29172

### Outside Micrometer



**Gear**

Graduation 0.01mm

OM-9198	0-25mm	NT\$5412
OM-9199	25-50mm	NT\$6072
OM-9200	50-75mm	NT\$6600
OM-9201	75-100mm	NT\$7260
OM-9202	100-125mm	NT\$7920
OM-9203	125-150mm	NT\$8580
OM-9204	150-175mm	NT\$9240

Precision steel-ball-tipped(optional)

### Digital Outside Micrometer

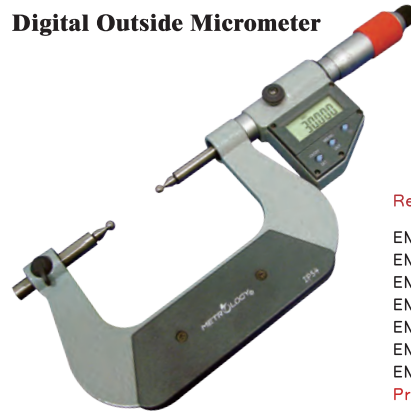

**Gear**

Resolution 0.001mm/0.00005"

EM-9198	0-25mm	NT\$9240
EM-9199	25-50mm	NT\$9636
EM-9200	50-75mm	NT\$10032
EM-9201	75-100mm	NT\$10428
EM-9202	100-125mm	NT\$10824
EM-9203	125-150mm	NT\$11220
EM-9204	150-175mm	NT\$11748

Precision steel-ball-tipped(optional)

**Universal**

AV-9001	Flat	NT\$528
AV-9002	Spherical	NT\$660
AV-9003	Blade	NT\$1320
AV-9004	Point	NT\$1056
AV-9005	Spine	NT\$1056
AV-9006	Disk	NT\$1056
AV-9007	Knife-edge	NT\$1716
AV-9008	Set	NT\$7392

**60° Screw Thread**

AV-9009	0.4-0.5mm/64-48TPI	NT\$924
AV-9010	0.6-0.9mm/44-28TPI	NT\$924
AV-9011	1-1.75mm/24-14TPI	NT\$924
AV-9012	2-3mm/13-9TPI	NT\$924
AV-9013	3.5-5mm/8-5TPI	NT\$924
AV-9014	5.5-7mm/4.5-3.5TPI	NT\$924
AV-9015	0.4-7mm/64-3.5TPI(Set)	NT\$5148

**Interchangeable Anvils**

**55° Screw Thread**

AV-9016	64-48TPI	NT\$924
AV-9017	48-40TPI	NT\$924
AV-9018	40-32TPI	NT\$924
AV-9019	32-24TPI	NT\$924
AV-9020	24-18TPI	NT\$924
AV-9021	18-14TPI	NT\$924
AV-9022	14-10TPI	NT\$924
AV-9023	10-7TPI	NT\$924
AV-9024	7-4.5TPI	NT\$924
AV-9025	4.5-3.5TPI	NT\$924
AV-9026	60-3.5TPI(Set)	NT\$8580

**Gear**

AV-9027	Φ 1.0mm	NT\$2904
AV-9028	Φ 1.5mm	NT\$2904
AV-9029	Φ 2.0mm	NT\$2904
AV-9030	Φ 2.5mm	NT\$2904
AV-9031	Φ 3.0mm	NT\$2904
AV-9032	Φ 3.5mm	NT\$2904
AV-9033	Φ 4.0mm	NT\$2904
AV-9034	Φ 4.5mm	NT\$2904
AV-9035	Φ 5.0mm	NT\$2904
AV-9036	Φ 6.0mm	NT\$2904
AV-9037	(Set)	NT\$28908

Anvil dia.5mm Length 4.5mm Overall length15mm

### Outside Micrometer

Graduation 0.01mm

OM-9178A	0-25mm	NT\$4488
OM-9179A	25-50mm	NT\$5016
OM-9180A	0-25mm	NT\$4752
OM-9181A	25-50mm	NT\$5412
OM-9182A	0-25mm	NT\$5940
OM-9183A	25-50mm	NT\$6240
OM-9184A	0-25mm	NT\$4488
OM-9185A	25-50mm	NT\$5016
OM-9178B	0-25mm	NT\$4752
OM-9179B	25-50mm	NT\$5412
OM-9180B	0-25mm	NT\$5940
OM-9181B	25-50mm	NT\$6204
OM-9182B	0-25mm	NT\$7920
OM-9183B	25-50mm	NT\$8580
OM-9184B	0-25mm	NT\$4488
OM-9185B	25-50mm	NT\$5016
OM-9178C	0-25mm	NT\$4752
OM-9179C	25-50mm	NT\$5412
OM-9180C	0-25mm	NT\$5940
OM-9181C	25-50mm	NT\$6204
OM-9182C	0-25mm	NT\$7920
OM-9183C	25-50mm	NT\$8580
OM-9184C	0-25mm	NT\$11880
OM-9185C	25-50mm	NT\$12276

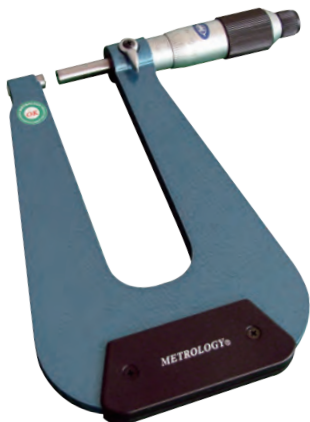

**Deep Throat**

### Digital Outside Micrometer



Resolution 0.001mm/0.00005"

EM-9178A	0-25mm	NT\$9372
EM-9179A	25-50mm	NT\$9768
EM-9180A	0-25mm	NT\$9636
EM-9181A	25-50mm	NT\$10032
EM-9182A	0-25mm	NT\$10164
EM-9183A	25-50mm	NT\$10692
EM-9184A	0-25mm	NT\$9372
EM-9185A	25-50mm	NT\$9768
EM-9178B	0-25mm	NT\$9372
EM-9179B	25-50mm	NT\$9768
EM-9180B	0-25mm	NT\$9636
EM-9181B	25-50mm	NT\$10032
EM-9182B	0-25mm	NT\$10164
EM-9183B	25-50mm	NT\$10692
EM-9184B	0-25mm	NT\$11484
EM-9185B	25-50mm	NT\$11880
EM-9178C	0-25mm	NT\$9372
EM-9179C	25-50mm	NT\$9768
EM-9180C	0-25mm	NT\$9636
EM-9181C	25-50mm	NT\$10032
EM-9182C	0-25mm	NT\$10164
EM-9183C	25-50mm	NT\$10692
EM-9184C	0-25mm	NT\$11484
EM-9185C	25-50mm	NT\$11880

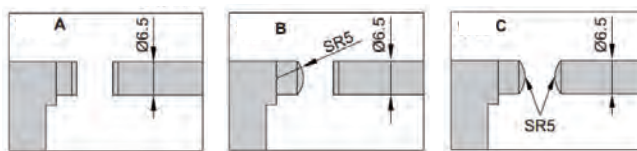

Outside Micrometer



**Large Anvil**

Graduation 0.01mm  
 OM-9186 0-25mm NT\$10032  
 OM-9187 25-50mm NT\$13200  
 Hardened steel big measuring anvil  
 Measuring spindle with tungsten carbide

Outside Micrometer

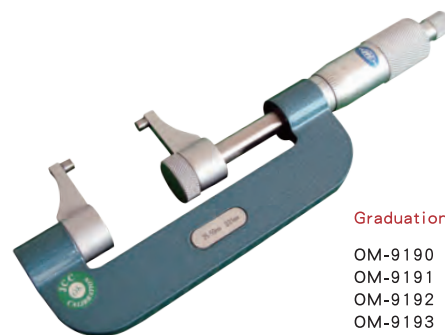

**Outside Caliper**

Graduation 0.01mm  
 OM-9190 0-25mm NT\$6204  
 OM-9191 25-50mm NT\$6864  
 OM-9192 50-75mm NT\$7656  
 OM-9193 75-100mm NT\$8316  
 Φ4mm L3.5mm  
 Radius tungsten carbide measuring anvil

Outside Micrometer



**Multi-Use**

Graduation 0.01mm  
 OM-9188 0-25mm NT\$7656  
 OM-9189 25-50mm NT\$8844  
 Interchangeable hardened steel anvil  
 Measuring spindle with carbide

Digital Outside Micrometer



**Multi-Use**

Resolution 0.001mm/0.00005"  
 EM-9188 0-25mm NT\$9504  
 EM-9189 25-50mm NT\$10428  
 Interchangeable hardened steel anvil  
 Measuring spindle with carbide

Outside Micrometer



**Disc Brake**

Graduation 0.01mm  
 OM-9205 7.6-33mm NT\$3036  
 OM-9206 25-50mm NT\$4092  
 Carbide measuring faces  
 Deep Throat 88mm Tip angle 30°

Digital Outside Micrometer



**Disc Brake**

Resolution 0.001mm/0.00005"  
 EM-9205 7.6-33mm NT\$8448  
 EM-9206 25-50mm NT\$8976  
 Carbide measuring faces  
 Deep Throat 88mm Tip angle 30°

Outside Micrometer



**Single Point**

Graduation 0.01mm  
 OM-9207B 0-25mm NT\$3564  
 OM-9208B 25-50mm NT\$3828  
 OM-9209B 50-75mm NT\$4092  
 OM-9210B 75-100mm NT\$4884  
 OM-9207C 0-25mm NT\$3564  
 OM-9207E 0-25mm NT\$3564  
 Carbide measuring faces

Digital Outside Micrometer



**Single Point**

Resolution 0.001mm/0.00005"  
 EM-9207B 0-25mm NT\$9108  
 EM-9208B 25-50mm NT\$9636  
 EM-9209B 50-75mm NT\$10296  
 EM-9210B 75-100mm NT\$10956  
 EM-9207C 0-25mm NT\$9108  
 EM-9207E 0-25mm NT\$9108  
 Carbide measuring faces

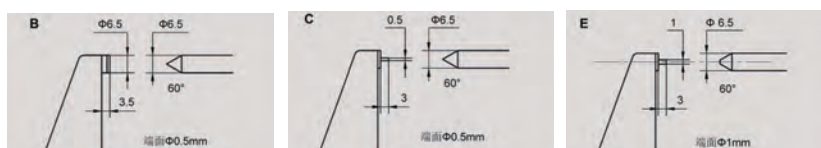



### Outside Micrometer



Graduation 0.01mm

OM-9211	0-25mm	NT\$4224
OM-9212	25-50mm	NT\$4884
OM-9213	50-75mm	NT\$5544
OM-9214	75-100mm	NT\$6204

### Outside Micrometer



Graduation 0.01mm

OM-9225	0-10mm	NT\$4092
---------	--------	----------

### Outside Micrometer



Graduation 0.002mm

OM-9216	0-25mm	NT\$4752
OM-9217	25-50mm	NT\$5676

### Outside Micrometer



Graduation 0.01mm

OM-9226	0-25mm	NT\$9372
OM-9227	25-50mm	NT\$10824
OM-9228	50-75mm	NT\$12144
OM-9229	75-100mm	NT\$14388

Hardened steel  $\Phi$ 60mm  
Non-rotating Spindle

### Outside Micrometer



OM-9222 Steel Can



OM-9223 Aluminum Can



OM-9224 Sprayer Can

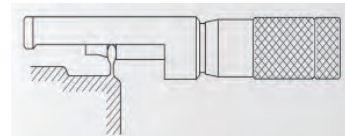
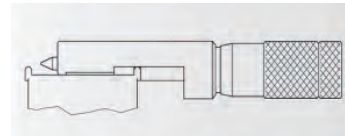

Graduation 0.01mm measuring range 0-13mm

OM-9222	NT\$4092	OM-9223	NT\$4092	OM-9224	NT\$4092
---------	----------	---------	----------	---------	----------

### Outside Micrometer



OM-9230

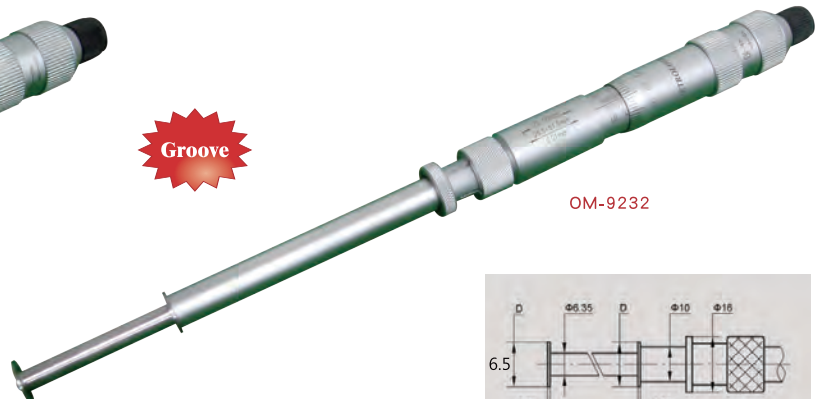

OM-9232

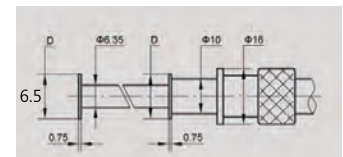

Graduation 0.01mm  
Non-rotating spindle and two directional ratchet stop

OM-9230	Outside 0-25mm	Inside 1.6-26.5mm	NT\$13464
OM-9231	Outside 0-25mm	Inside 1.6-26.5mm	NT\$13464
OM-9232	Outside 25-50mm	Inside 26.5-51.5mm	NT\$19668
OM-9233	Outside 50-75mm	Inside 51.5-76.5mm	NT\$22704
OM-9234	Outside 75-100mm	Inside 76.5-101.5mm	NT\$26004

**Outside Micrometer**

**Micro Rapid Indicator**



Dial indicator Graduation 0.001mm		Micrometer Graduation 0.002mm	
OM-9235	0-25mm	NT\$13596	
OM-9236	25-50mm	NT\$15708	
OM-9237	50-75mm	NT\$17160	
OM-9238	75-100mm	NT\$19932	

**Outside Dial Snap Comparator**

**Standard Rapid Indicator**



Dial indicator Graduation 0.01mm		Micrometer Graduation 0.01mm	
OM-SC01N	0-25mm	NT\$7260	
OM-SC02N	25-50mm	NT\$7788	
OM-SC03N	50-75mm	NT\$10296	
OM-SC04N	75-100mm	NT\$10956	
OM-SC05N	100-125mm	NT\$11484	
OM-SC06N	125-150mm	NT\$12144	
OM-SC07N	150-175mm	NT\$12672	

**Outside Dial Snap Comparator**

**Long Travel**



Dial or digital indicator(Optional)			
OM-SC00L	0-50mm	NT\$4884	
OM-SC50L	50-100mm	NT\$5808	
OM-SC100L	100-150mm	NT\$8580	
OM-SC150L	150-200mm	NT\$9900	

**Outside Dial Snap Comparator**

**Universal**



Indicator & measuring anvil(Optional)			
OM-SC00U	0-40mm	NT\$6336	
OM-SC40U	40-90mm	NT\$9504	
OM-SC90U	90-140mm	NT\$11088	
OM-SC140U	140-190mm	NT\$12804	

**Micrometer Stands**

**Cast Iron (Simple)**



**Cast Iron (Normal)**

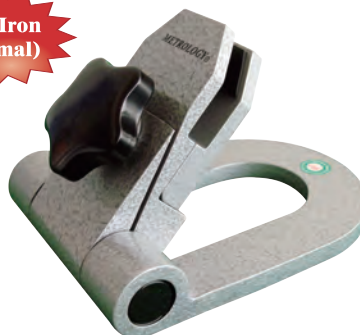

**Hardened Steel (Heavy)**



MS-9000S	Clamp Thickness 15mm	NT\$1056	MS-9000N	Clamp Thickness 18mm	NT\$1452	MS-9000H	Clamp Thickness 25mm	NT\$5676
----------	----------------------	----------	----------	----------------------	----------	----------	----------------------	----------



### Depth Micrometer

**Vernier**



DM-9002

Graduation 0.01mm

Measuring Rod  $\Phi$ 4.5mm, Base Length L:63mm

DM-9001	0-25mm	NT\$3036
DM-9002	0-50mm	NT\$3670
DM-9003	0-100mm	NT\$5016
DM-9004	0-150mm	NT\$7656
DM-9005	0-200mm	NT\$9504
DM-9006	0-300mm	NT\$12408

Measuring Rod  $\Phi$ 4.5mm, Base Length L:101.5mm

DM-9007	0-25mm	NT\$3036
DM-9008	0-50mm	NT\$3696
DM-9009	0-100mm	NT\$5148
DM-9010	0-150mm	NT\$7656
DM-9011	0-200mm	NT\$9504
DM-9012	0-300mm	NT\$12408

**Mechanical Digits**



DM-9009D

Graduation 0.01mm

Measuring Rod  $\Phi$ 4.5mm, Base Length L:63mm

DM-9001D	0-25mm	NT\$3828
DM-9002D	0-50mm	NT\$4356
DM-9003D	0-100mm	NT\$6732
DM-9004D	0-150mm	NT\$8316
DM-9005D	0-200mm	NT\$10824
DM-9006D	0-300mm	NT\$14652

Measuring Rod  $\Phi$ 4.5mm, Base Length L:101.5mm

DM-9007D	0-25mm	NT\$3828
DM-9008D	0-50mm	NT\$4356
DM-9009D	0-100mm	NT\$6732
DM-9010D	0-150mm	NT\$8316
DM-9011D	0-200mm	NT\$10824
DM-9012D	0-300mm	NT\$14652

**Digital**



DM-9001E

Resolution 0.001mm/0.00005"

Measuring Rod  $\Phi$ 4.5mm, Base Length L:63mm

DM-9001E	0-25mm	NT\$7128
DM-9002E	0-50mm	NT\$7392
DM-9003E	0-100mm	NT\$10032
DM-9004E	0-150mm	NT\$10956
DM-9005E	0-200mm	NT\$11748
DM-9006E	0-300mm	NT\$13728

Measuring Rod  $\Phi$ 4.5mm, Base Length L:101.5mm

DM-9007E	0-25mm	NT\$7128
DM-9008E	0-50mm	NT\$7392
DM-9009E	0-100mm	NT\$10032
DM-9010E	0-150mm	NT\$10956
DM-9011E	0-200mm	NT\$11748
DM-9012E	0-300mm	NT\$13728

### Inside Micrometer (Caliper Type)

**Vernier**



IM-9002

Graduation 0.01mm

IM-9001	5-30mm	NT\$2904
IM-9002	25-50mm	NT\$3036
IM-9003	50-75mm	NT\$4488
IM-9004	75-100mm	NT\$5016
IM-9005	100-125mm	NT\$5676
IM-9006	125-150mm	NT\$6204
IM-9007	150-175mm	NT\$6864
IM-9008	175-200mm	NT\$7392

**Mechanical Digits**



IM-9001D

Graduation 0.01mm

IM-9001D	5-30mm	NT\$4884
IM-9002D	25-50mm	NT\$5148
IM-9003D	50-75mm	NT\$7128
IM-9004D	75-100mm	NT\$7524
IM-9005D	100-125mm	NT\$8316
IM-9006D	125-150mm	NT\$9108
IM-9007D	150-175mm	NT\$9636
IM-9008D	175-200mm	NT\$10560

**Digital**



IM-9001E

Resolution 0.001mm/0.00005"

IM-9001E	5-30mm	NT\$7392
IM-9002E	25-50mm	NT\$7656
IM-9003E	50-75mm	NT\$10032
IM-9004E	75-100mm	NT\$10428
IM-9005E	100-125mm	NT\$10956
IM-9006E	125-150mm	NT\$11484
IM-9007E	150-175mm	NT\$12144
IM-9008E	175-200mm	NT\$12936

### Outside Micrometer

**Interchangeable Rod**



Graduation 0.01mm

With Micrometer head & rod (Set)		
IM-9009	50-200mm	NT\$7656
IM-9010	50-300mm	NT\$8580
IM-9011	200-500mm	NT\$10560
IM-9012	200-1000mm	NT\$35508

Micrometer head

IM-9013	25-32mm	NT\$5544
IM-9014	25-50mm	NT\$5808
IM-9009A	50-63mm	NT\$5808
IM-9011A	200-225mm	NT\$7920

**Extension Rod Type**



Graduation 0.01mm

With Micrometer head & rod (Set)		
IM-9016	50-100mm	NT\$4884
IM-9017	50-150mm	NT\$5148
IM-9018	50-300mm	NT\$7128
IM-9019	50-500mm	NT\$8844
IM-9020	50-1000mm	NT\$29436
IM-9021	50-1500mm	NT\$55308
IM-9023	100-500mm	NT\$17688
IM-9024	100-900mm	NT\$25344
IM-9025	100-1300mm	NT\$38412
IM-9026	100-1700mm	NT\$60456

Micrometer head

IM-9015	50-63mm	NT\$4620
IM-9022	100-125mm	NT\$11748
IM-9028	1000-1050mm	NT\$27060

**Single Rod**



Graduation 0.01mm

IM-9037	50-75mm	NT\$2640
IM-9038	75-100mm	NT\$2904
IM-9039	100-125mm	NT\$3300
IM-9040	125-150mm	NT\$3696
IM-9041	150-175mm	NT\$3960
IM-9042	175-200mm	NT\$4224
IM-9043	200-225mm	NT\$4620
IM-9044	225-250mm	NT\$4884
IM-9045	250-275mm	NT\$5280
IM-9046	275-300mm	NT\$5676
IM-9047	300-325mm	NT\$5940
IM-9048	325-350mm	NT\$6336
IM-9049	350-375mm	NT\$6864
IM-9050	375-400mm	NT\$7392
IM-9051	400-425mm	NT\$7788
IM-9052	425-450mm	NT\$8184
IM-9053	450-475mm	NT\$8580
IM-9054	475-500mm	NT\$8844
IM-9074	975-1000mm	NT\$15972

**Three Point Inside Micrometer**

**Vernier**



TP-9010

Graduation 0.001mm

TP-9020

Graduation 0.005mm

TP-9050

Graduation 0.005mm

<b>Single set</b>	TP-9006	6-8mm	NT\$9167	TP-9012	12-16mm	NT\$6792	TP-9025	25-30mm	NT\$9579	TP-9050	50-63mm	NT\$12904
	TP-9008	8-10mm	NT\$9167	TP-9016	16-20mm	NT\$6792	TP-9030	30-40mm	NT\$10544	TP-9062	62-75mm	NT\$13854
	TP-9010	10-12mm	NT\$9167	TP-9020	20-25mm	NT\$9579	TP-9040	40-50mm	NT\$12223	TP-9075	75-88mm	NT\$14487
										TP-9087	87-100mm	NT\$15184

<b>Full set</b>	TP-01S	6-12mm	NT\$24024	TP-02S	12-20mm	NT\$11920	TP-03S	20-30mm	NT\$16724	TP-04S	30-50mm	NT\$19958	TP-05S	50-100mm	NT\$49342
-----------------	--------	--------	-----------	--------	---------	-----------	--------	---------	-----------	--------	---------	-----------	--------	----------	-----------

**Three Point Inside Micrometer**

**Digital**

Resolution 0.001mm/0.00005"



TP-9006E

TP-9016E

TP-9050E

<b>Single set</b>	TP-9006E	6-8mm	NT\$15658	TP-9012E	12-16mm	NT\$15184	TP-9025E	25-30mm	NT\$15818	TP-9050E	50-63mm	NT\$18825
	TP-9008E	8-10mm	NT\$15658	TP-9016E	16-20mm	NT\$15184	TP-9030E	30-40mm	NT\$17717	TP-9062E	62-75mm	NT\$19933
	TP-9010E	10-12mm	NT\$15658	TP-9020E	20-25mm	NT\$15818	TP-9040E	40-50mm	NT\$17717	TP-9075E	75-88mm	NT\$20726
										TP-9087E	87-100mm	NT\$21675

<b>Full set</b>	TP-01EFS	6-12mm	NT\$41118	TP-02EFS	12-20mm	NT\$26611	TP-03EFS	20-30mm	NT\$27720	TP-04EFS	30-50mm	NT\$31046	TP-05EFS	50-100mm	NT\$70963
-----------------	----------	--------	-----------	----------	---------	-----------	----------	---------	-----------	----------	---------	-----------	----------	----------	-----------

**Three Point Inside Micrometer**

**Pistol-Grip**

Indicators(Optional)



TP-9010P

TP-9030P

<b>Single set</b>	TP-9006P	6-8mm	NT\$11875	TP-9012P	12-16mm	NT\$12477	TP-9025P	25-30mm	NT\$14994	TP-9050P	50-63mm	NT\$18303
	TP-9008P	8-10mm	NT\$11637	TP-9016P	16-20mm	NT\$13220	TP-9030P	30-40mm	NT\$16134	TP-9062P	62-75mm	NT\$19491
	TP-9010P	10-12mm	NT\$12334	TP-9020P	20-25mm	NT\$14075	TP-9040P	40-50mm	NT\$17179	TP-9075P	75-88mm	NT\$20757
										TP-9087P	87-100mm	NT\$22103

<b>Full set</b>	TP-9001PS	6-12mm	NT\$26242	TP-9002PS	2-20mm	NT\$16817	TP-9003PS	20-30mm	NT\$20698	TP-9004PS	30-50mm	NT\$24763	TP-9005PS	50-100mm	NT\$54054
-----------------	-----------	--------	-----------	-----------	--------	-----------	-----------	---------	-----------	-----------	---------	-----------	-----------	----------	-----------

**Three Point Inside Micrometer**

**Digital Reading Head**

Resolution 0.001mm/0.00005"



**Measuring Pistol**



**Extension Rod**



TP-01MH	6-12mm use	NT\$9240	TP-01SG	6-12mm use	NT\$5940	EX-01	L:100	6-12mm use	NT\$1320
TP-02MH	12-20mm use	NT\$9240	TP-02SG	12-20mm use	NT\$6600	EX-02	L:150	12-20mm use	NT\$1584
TP-03MH	20-30mm use	NT\$9240	TP-03SG	20-30mm use	NT\$7392	EX-03	L:150	20-30mm use	NT\$1584
TP-04MH	30-50mm use	NT\$9240	TP-04SG	30-50mm use	NT\$8052	EX-04	L:150	30-50mm use	NT\$1980
TP-05MH	50-100mm use	NT\$9240	TP-05SG	50-100mm use	NT\$8844	EX-05	L:150	50-100mm use	NT\$2640



### Three Point Inside Micrometer

Long Travel



Vernier

Graduation 0.001mm

TP-9050L	50-70mm	NT\$14124
TP-9070L	70-100mm	NT\$18744
TP-9100L	100-150mm	NT\$31944
TP-9150L	150-250mm	NT\$67188
TP-9200L	200-300mm	NT\$94776

Digital

Resolution 0.001mm/0.00005"

TP-9050EL	50-70mm	NT\$21120
TP-9070EL	70-100mm	NT\$28380
TP-9100EL	100-150mm	NT\$46728
TP-9150EL	150-250mm	NT\$95568
TP-9200EL	200-300mm	NT\$133980

### Micrometer Head

Vernier

Graduation 0.01mm

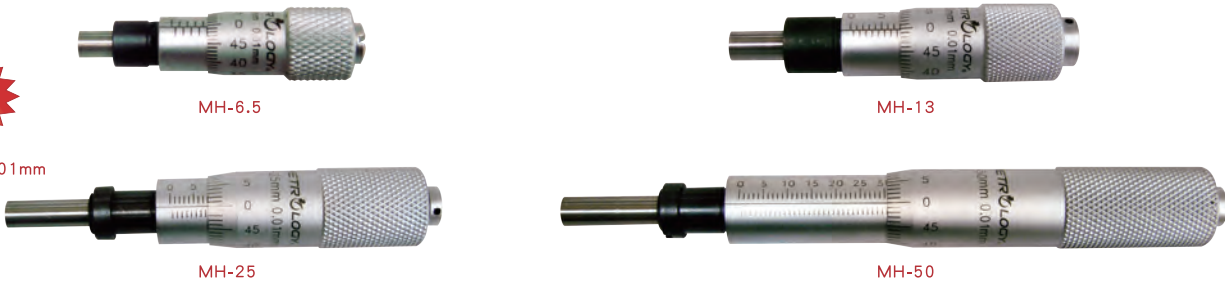

MH-6.5	0-6.5mm	Spindle $\Phi$ 3.5mm	Stem $\Phi$ 6mm	Thimble $\Phi$ 9.5mm	Overall L:37mm	NT\$726
MH-13	0-13mm	Spindle $\Phi$ 5mm	Stem $\Phi$ 9.5mm	Thimble $\Phi$ 13.4mm	Overall L:59mm	NT\$726
MH-25	0-25mm	Spindle $\Phi$ 6.5mm	Stem $\Phi$ 10mm	Thimble $\Phi$ 18.2mm	Overall L:98mm	NT\$792
MH-50	0-50mm	Spindle $\Phi$ 6.5mm	Stem $\Phi$ 10mm	Thimble $\Phi$ 18.2mm	Overall L:146mm	NT\$1980

### Micrometer Head

Digital

Resolution 0.001mm/0.00005"

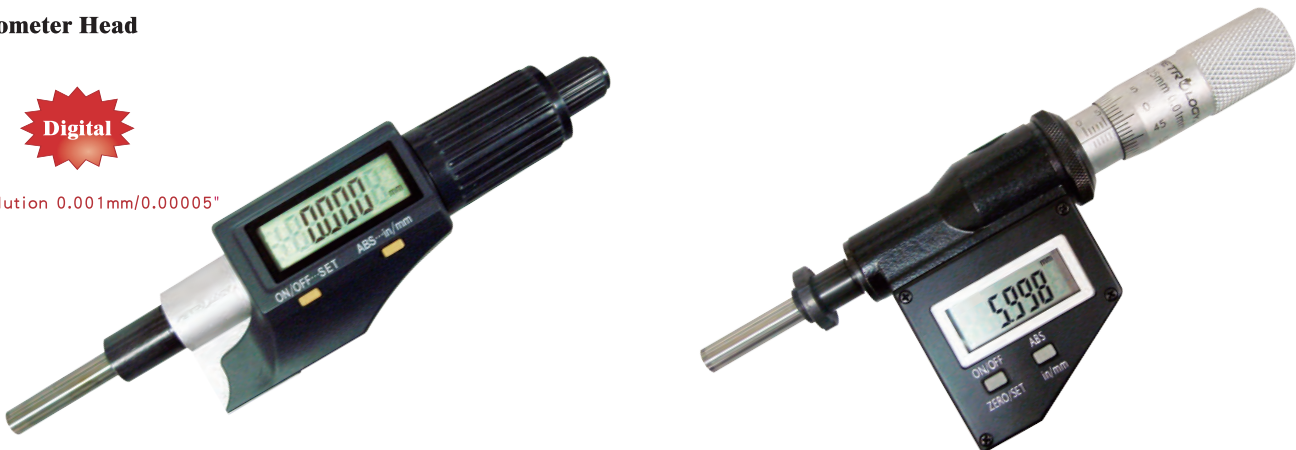

MH-28E	0-25mm/0-1"	NT\$2376
MH-30E	0-25mm/0-1"	NT\$4092
MH-31E	0-50mm/0-2"	NT\$5280

**Description of model**

F: Flat measuring face  
 FN: Flat measuring face with clamp nut  
 FL: Flat measuring face with spindle lock  
 FLN: Flat measuring face with spindle lock & clamp nut

S: Spherical measuring face  
 SN: Spherical measuring face with clamp nut  
 SL: Spherical measuring face with spindle lock  
 SLN: Spherical measuring face with spindle lock & clamp nut

**Micrometer Head**



MH-01F

Graduation 0.02mm  
 MH-01F 0-5mm NT\$1056  
 MH-01S 0-5mm NT\$1056

**Small**

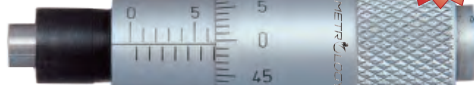

MH-02F

Graduation 0.01mm  
 MH-02F 0-6.5mm NT\$1056  
 MH-02S 0-6.5mm NT\$1056  
 MH-02FN 0-6.5mm NT\$1188  
 MH-02SN 0-6.5mm NT\$1188

**Small**



MH-03FN

Graduation 0.01mm  $\Phi$ 20mm Thimble  
 MH-03F 0-6.5mm NT\$2112  
 MH-03S 0-6.5mm NT\$2112  
 MH-03FN 0-6.5mm NT\$2376  
 MH-03SN 0-6.5mm NT\$2376

**Large Thimble**

**Micrometer Head**



MH-04F

Graduation 0.0005mm  
 MH-04F 0-6.5mm NT\$6864  
 MH-04S 0-6.5mm NT\$6864

**Fine Reading**



MH-05FLN

Graduation 0.01mm  
 MH-05F 0-13mm NT\$884  
 MH-05S 0-13mm NT\$884  
 MH-05FN 0-13mm NT\$1043  
 MH-05SN 0-13mm NT\$1043  
 MH-05FL 0-13mm NT\$1043  
 MH-05SL 0-13mm NT\$1043  
 MH-05FLN 0-13mm NT\$1214  
 MH-05SLN 0-13mm NT\$1214



MH-06S

Graduation 0.005mm  
 MH-06F 0-13mm NT\$2244  
 MH-06S 0-13mm NT\$2244  
 MH-06FN 0-13mm NT\$2376  
 MH-06SN 0-13mm NT\$2376

**Fine Reading**

**Micrometer Head**



MH-07F

Graduation 0.01mm  
 MH-07F 0-13mm NT\$1320  
 MH-07S 0-13mm NT\$1320  
 MH-07FN 0-13mm NT\$1584  
 MH-07SN 0-13mm NT\$1584  
 MH-07FL 0-13mm NT\$1584  
 MH-07SL 0-13mm NT\$1584  
 MH-07FLN 0-13mm NT\$1716  
 MH-07SLN 0-13mm NT\$1716

**Variable Zero Settings**



MH-08FN

Graduation 0.01mm  $\Phi$ 29mm Thimble  
 MH-08F 0-13mm NT\$1452  
 MH-08S 0-13mm NT\$1452  
 MH-08FN 0-13mm NT\$1716  
 MH-08SN 0-13mm NT\$1716

**Large Thimble**



MH-09FL

Graduation 0.01mm  
 MH-09F 0-15mm NT\$884  
 MH-09S 0-15mm NT\$884  
 MH-09FN 0-15mm NT\$1043  
 MH-09SN 0-15mm NT\$1043  
 MH-09FL 0-15mm NT\$1043  
 MH-09SL 0-15mm NT\$1043  
 MH-09FLN 0-15mm NT\$1214  
 MH-09SLN 0-15mm NT\$1214

**Micrometer Head**



MH-10F

Graduation 0.01mm  $\Phi$ 29mm Thimble  
 MH-10F 0-15mm NT\$1452  
 MH-10S 0-15mm NT\$1452  
 MH-10FN 0-15mm NT\$1716  
 MH-10SN 0-15mm NT\$1716

**100 Step Graduation**



MH-13F

Graduation 0.01mm  
 MH-13F 0-25mm NT\$924  
 MH-13S 0-25mm NT\$924  
 Graduation 0.002mm  
 MH-13FH 0-25mm NT\$1188  
 MH-13SH 0-25mm NT\$1188



MH-14F

Graduation 0.01mm  
 MH-14F 0-25mm NT\$924  
 MH-14S 0-25mm NT\$924  
 MH-14FN 0-25mm NT\$1188  
 MH-14SN 0-25mm NT\$1188

**Micrometer Head**



MH-15F

Graduation 0.01mm  
 MH-15F 0-25mm NT\$1188  
 MH-15S 0-25mm NT\$1188  
 MH-15FN 0-25mm NT\$1320  
 MH-15SN 0-25mm NT\$1320

**Non-Rotating Spindle**



MH-16F

Graduation 0.01mm  
 MH-16F 0-25mm NT\$2112  
 MH-16S 0-25mm NT\$2112  
 Graduation 0.002mm  
 MH-16FH 0-25mm NT\$2112  
 MH-16SH 0-25mm NT\$2112

**Micro Parallax Free**



MH-17F

Graduation 0.001mm  
 MH-17F 0-25mm NT\$2112  
 MH-17S 0-25mm NT\$2112



### Micrometer Head

**Mechanical Digits**

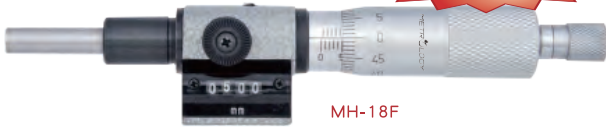

MH-18F

Graduation 0.01mm

MH-18F	0-25mm	NT\$1848
MH-18S	0-25mm	NT\$2112



MH-19FLN

Graduation 0.01mm

MH-19F	0-25mm	NT\$1188
MH-19FLN	0-25mm	NT\$1320



MH-20F

**1 mm per revolution**

**100 Step Graduation**

Graduation 0.01mm  $\Phi$ 29mm Thimble

MH-20F	0-25mm	NT\$2112
MH-20S	0-25mm	NT\$2112

### Micrometer Head

**Long Travel**



MH-21F

Graduation 0.01mm

MH-21F	0-50mm	NT\$8276
MH-21S	0-50mm	NT\$9196
MH-21FN	0-50mm	NT\$8276
MH-21SN	0-50mm	NT\$9196



MH-22F

Graduation 0.01mm

MH-22F	0-50mm	NT\$7524
MH-22S	0-50mm	NT\$7524
MH-22FN	0-50mm	NT\$8360
MH-22SN	0-50mm	NT\$8360



MH-23S

**1 mm per revolution**

**100 Step Graduation**

Graduation 0.01mm  $\Phi$ 29mm Thimble

MH-23F	0-50mm	NT\$9372
MH-23S	0-50mm	NT\$9372

### Digital Micrometer Head



Resolution 0.001mm/0.00005"

MH-28F	0-25mm	NT\$3294
MH-28S	0-25mm	NT\$3294

Ratchet friction thimble measuring force



Resolution 0.001mm/0.00005"

MH-29F	0-25mm	NT\$5146
MH-29S	0-25mm	NT\$5146

Ratchet friction thimble measuring force

### Digital Micrometer Head



MH-30F

Resolution 0.001mm/0.00005"

MH-30F	0-25mm	NT\$4734	MH-30FNR	0-25mm	NT\$4861
MH-30S	0-25mm	NT\$4734	MH-30UNR	0-25mm	NT\$6291
MH-30FN	0-25mm	NT\$4861			
MH-30SN	0-25mm	NT\$4861			

FNR: Flat measuring face \ non-rotating spindle  
UNR: Universal interchangeable anvil \ non-rotating spindle



MH-31F

MH-31F	0-50mm	NT\$7600
MH-31S	0-50mm	NT\$7600

### Digital Micrometer Head

**IP65 Fast**

**2mm per revolution**



Rotating spindle

Resolution 0.001mm/0.00005"

MH-32F	0-25mm	NT\$8918
MH-32S	0-25mm	NT\$8956

FNR: Flat measuring face \ non-rotating spindle  
UNR: Universal interchangeable anvil \ non-rotating spindle

**2mm per revolution**



Non-rotating spindle

Resolution 0.001mm/0.00005"

MH-32FNR	0-25mm	NT\$10582
MH-32UNR	0-25mm	NT\$10761

**Dial Gauges**



**Small Bezel**

DG-9005S

Graduation 0.01mm

DG-9003S	0-3mm	NT\$924
DG-9004S	0-4mm	NT\$1584
DG-9005S	0-5mm	NT\$924



**Aluminum body**

DG-9010A

Graduation 0.01mm

DG-9010A	0-10mm	NT\$884
DG-9020A	0-20mm	NT\$1848



**Steel body**

DG-9010R

Graduation 0.01mm

DG-9010R	0-10mm	NT\$1020
----------	--------	----------



Magnetic Stands (Optional)

**Dial Gauges**



**Hoist Type**

DG-9010HI

Graduation 0.01mm

DG-9010HI	0-10mm	NT\$1452
-----------	--------	----------

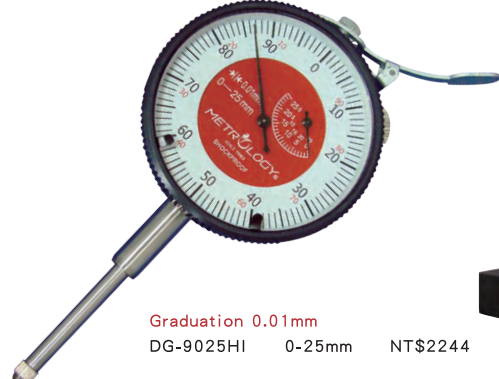

DG-9025HI

Graduation 0.01mm

DG-9025HI	0-25mm	NT\$2244
-----------	--------	----------



Measuring Stands (Optional)

**Dial Gauges**



**Long Travel**

DG-9050

Graduation 0.01mm

DG-9030	0-30mm	NT\$2904
DG-9050	0-50mm	NT\$4356
DG-9080	0-80mm	NT\$7788



**Long Travel & Large Bezel**

DG-9050L

Graduation 0.01mm

DG-9030L	0-30mm	NT\$4224
DG-9050L	0-50mm	NT\$5280
DG-9100L	0-100mm	NT\$10956



Measuring Stands (Optional)



**Micro**

DG-9005H

Graduation 0.001mm

DG-9001H	0-1mm	NT\$2323
DG-9003H	0-3mm	NT\$4008
DG-9005H	0-5mm	NT\$5293



**High Accuracy Comparison**

DG-COMP

Graduation 0.001mm Stem  $\Phi$ 8mm

DG-COMP	$\pm 0.05$ mm	NT\$10365
---------	---------------	-----------

Graduation 0.0002mm Stem  $\Phi$ 28mm

DG-COMP02	$\pm 0.006$ mm	NT\$13200
-----------	----------------	-----------



### Digital Dial Gauge



**Standard**



**Normal Micro**



**Rotatable Micro & Small Bezel**



**Micro**

HW: Waterproof

Resolution 0.01mm/0.0005"  
ED-9010 0-12.7mm NT\$2244  
ED-9025 0-25mm NT\$3300

Resolution 0.001mm/0.00005"  
ED-9013HN 0-12.7mm NT\$4224

Resolution 0.001mm/0.00005"  
ED-9007H 0-6.5mm NT\$7239

Resolution 0.001mm/0.00005"  
ED-9013H 0-12.7mm NT\$8839  
ED-9013HW 0-12.7mm NT\$9528

### Digital Dial Gauge



**Vertical**

ED-9012H



**Horizontal**

ED-9030HH

Resolution 0.01mm/0.0005"  
ED-9012N 0-12.7mm NT\$3828  
ED-9025N 0-25mm NT\$4488  
ED-9050N 0-50mm NT\$5940  
ED-9100N 0-100mm NT\$7656

Resolution 0.001mm/0.00005"  
ED-9012H 0-12.7mm NT\$5148  
ED-9025H 0-25mm NT\$6336  
ED-9050H 0-50mm NT\$7920  
ED-9100H 0-100mm NT\$10560



Measuring Stand(optional)

Resolution 0.001mm/0.00005"  
ED-9013HH 0-12.7mm NT\$5940  
ED-9030HH 0-30mm NT\$7128

### Contact Points

DI-S27 Spherical point  
NT\$264

DI-F5 Flat point  
NT\$475

DI-D1.5 Needle point  
NT\$475

DI-F10 Flat point  
NT\$475

DI-T0.3 Taper point  
NT\$475

DI-B3 Ball point  
NT\$132

DI-S17 Spherical point  
NT\$264

DI-F10C Ceramic flat point  
NT\$475

DI-ER10 Extension rod  
NT\$238

DI-ER20 Extension rod  
NT\$238

DI-S37 Spherical point  
NT\$264



**Rotatable Bezel**

ED-9025HA

Data output link  
DO-B+C04 NT\$3036

Bluetooth wireless data transmitter  
DO-W2-RS NT\$1716

Resolution 0.001mm/0.00005"  
ED-9013HA 0-12.7mm NT\$6230  
ED-9025HA 0-25mm NT\$7969  
ED-9050HA 0-50mm NT\$11781

Screw specifications : : M2.5-6g (Common Specifications for Global Brands)

**Measuring Stand**

**Chrome Steel  
Fine adjustment**



MS-S90 Φ90mm NT\$12000

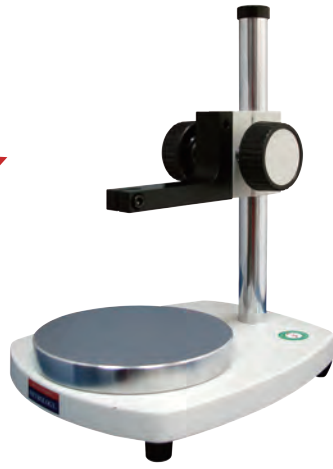

MS-S150 Φ150mm NT\$13680

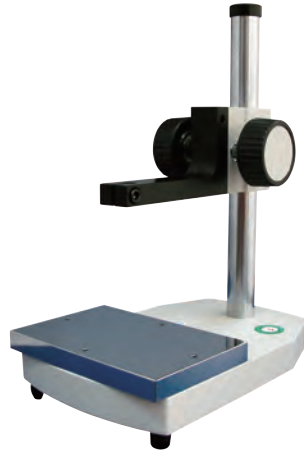

MS-S1510 150\*100mm NT\$13680



MS-S2015 200\*150mm NT\$15480

**Level Type Dial Indicator**

**Standard**

**Long Measuring Inserts**

**Micro**

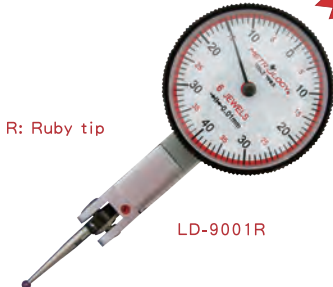

R: Ruby tip

LD-9001R



SL: Φ30  
Small bezel

SLL: Φ37.5  
Large bezel

LD-9001SL



L: Φ38  
Large bezel

LD-9002LR



LR: Φ38  
Large bezel  
Ruby tip

LD-9003

Graduation 0.01mm

- LD-9001 0-0.8mm NT\$1452
- LD-9001R 0-0.8mm NT\$1848

Graduation 0.01mm

- LD-9001SL 0-0.8mm NT\$3551

Graduation 0.005mm

- LD-9001SLL 0-0.8mm NT\$3559

Graduation 0.005mm

- LD-9002L 0-0.8mm NT\$1848
- LD-9002LR 0-0.8mm NT\$2376

Graduation 0.002mm

- LD-9003 0-0.2mm NT\$3485
- LD-9003R 0-0.2mm NT\$3717
- LD-9003L 0-0.2mm NT\$3485
- LD-9003LR 0-0.2mm NT\$3717

**Level Type Dial Indicator**

**Measuring Inserts**

Centering Holder Clamping Diagram



Dovetail grip



- LD-MS4 Φ4 NT\$198
- LD-MS6 Φ6 NT\$198
- LD-MS8 Φ8 NT\$198

LD-3S2 M1.6\*12L  
NT\$370

LD-12R2 M1.8\*18L  
NT\$396

LD-12S2 M1.8\*18L  
NT\$264

LD-1LS2 M2\*26L  
NT\$304

LD-4R2 M2\*10L  
NT\$396

LD-3R2 M1.6\*12L  
NT\$462

LD-4S2 M2\*10L  
NT\$264

LD-3S2 M1.6\*12L  
NT\$370

LD-1LR2 M2\*26L NT\$436

LD-1LS2 M1.6\*44L  
LD-1SLR2 M1.6\*44L  
NT\$528

PS. S: Steel R: Ruby



### Level-Type Dial Indicator Accessories



LD-A1 Swivel clamp head NT\$792  
 LD-C1 Round clamping rod NT\$554  
 LD-C2 Rectangular clamping rod NT\$554

Dial Indicator(Optional)

LD-UC Universal clamp NT\$792  
 LD-CS Centering holder NT\$792

### Magnetic Stands

**Standard**



MS-N80K

**Standard Fine-Adjustment**



MS-NF80K

**Standard Fine-Adjustment**



MS-NF100K

**Standard Fine-Adjustment**



MS-NF130K

Mounting hole dia  $\Phi 6.0$  &  $\Phi 8.0$ mm

MS-N80K	Magnetic Power 80kg	Base(LxWxH)60*50*55mm	NT\$726
MS-NF80K	Magnetic Power 80kg	Base(LxWxH)60*50*55mm	NT\$871
MS-NF100K	Magnetic Power 100kg	Base(LxWxH)73*50*55mm	NT\$1510
MS-NF130K	Magnetic Power 130kg	Base(LxWxH)117*50*55mm	NT\$2062

Dial Indicator(Optional)

### Magnetic Stands

**Transfer & Precision Fine-adjustment**

Mounting hole dia  $\Phi 6.0$  &  $\Phi 8.0$ mm & Dovetail grip  
 Dial Indicator(Optional)



MS-SF80K



MS-SF100K



MS-SF80K Magnetic Power 80kg Base(LxWxH)60\*50\*55mm NT\$2323

MS-SF100K Magnetic Power 100kg Base(LxWxH)73\*50\*55mm NT\$2672

**Magnetic Stands**

**Mechanical Universal & Precision Fine-Adjustment**

Mounting hole dia  $\Phi 6.0$  &  $\Phi 8.0$ mm & Dovetail grip



MS-MU250L Magnetic Power 80kg NT\$2323



MS-MU350L Magnetic Power 80kg NT\$2614



MS-MU460L Magnetic Power 100kg NT\$2962

**Magnetic Stands**

**Mechanical Universal & Fine-Adjustment**

**Mini Mechanical Universal**

**Hydraulic Universal & Precision Fine-Adjustment**

Mounting hole dia  $\Phi 6.0$  &  $\Phi 8.0$ mm & Dovetail grip



Normal Fine-Adjustment

MS-MU80K Magnetic Power 80kg NT\$1307

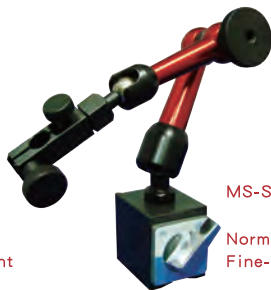

MS-SU30K

Normal Fine-Adjustment

MS-SU30K Magnetic Power 30kg NT\$1162  
MS-SU50K Magnetic Power 50kg NT\$2178

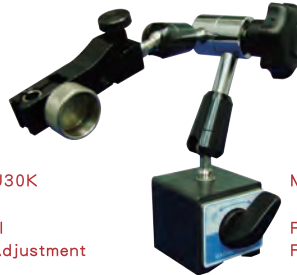

MS-SU50K

Precision Fine-Adjustment

MS-MU345L Magnetic Power 80kg NT\$3485



**Magnetic Stands (V-Block)**

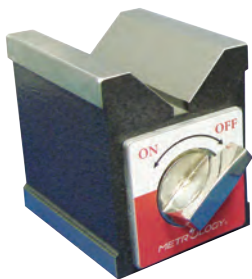

MV-70L Magnetic Power 60kg Base 70\*60\*72mm NT\$1888



MV-100L Magnetic Power 70kg Base 100\*70\*95mm NT\$3340

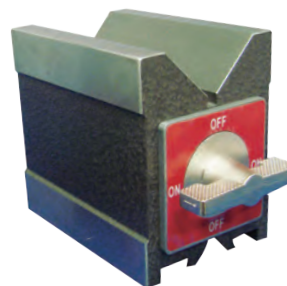

**Magnetic Base**



MS-130K NT\$1016  
Magnetic Power 130kg  
Size 117\*50\*55mm M10



MS-100K NT\$726  
Magnetic Power 100kg  
Size 73\*50\*55mm M8



MS-80K NT\$436  
Magnetic Power 80kg  
Size 60\*50\*55mm M8



MS-50K NT\$436  
Magnetic Power 50kg  
Size 40\*40\*40mm M5



MS-30K NT\$436  
Magnetic Power 30kg  
Size 30\*35\*35mm M5



### Depth Gauge (Extension rod type)



DD-9200	0-200mm	Graduation 0.01mm	NT\$3300
DD-9200E	0-200mm/8"	Resolution 0.01mm/0.0005"	NT\$6072
DD-9200EH	0-200mm/8"	Resolution 0.001mm/0.00005"	NT\$14256

### Dial Gauge Depth Base

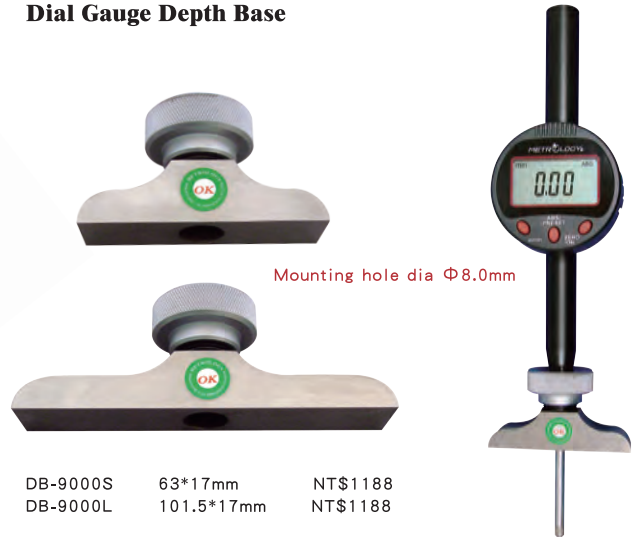

DB-9000S	63*17mm	NT\$1188
DB-9000L	101.5*17mm	NT\$1188

Mounting hole dia  $\Phi$ 8.0mm

### Outside Dial Caliper Gauge

Graduation 0.05mm Measuring Range 0-10mm



DS-9001	NT\$2376	Deep throat L:35mm Radius anvil
DS-9002	NT\$2376	Deep throat L:35mm Flat anvil
DS-9003	NT\$2376	Deep throat L:35mm Tube type anvil
DS-9004	NT\$2640	Deep throat L:60mm Tube type anvil

### Outside Dial Caliper Gauge



Graduation 0.01mm

OC-9000	0-20mm	NT\$4488	OC-9060	60-80mm	NT\$4488
OC-9020	20-40mm	NT\$4488	OC-9080	80-100mm	NT\$7128
OC-9040	40-60mm	NT\$4488			

### Inside Dial Caliper Gauge



Graduation 0.01mm

IC-9015	15-35mm	NT\$4488	IC-9075	75-95mm	NT\$4488
IC-9035	35-55mm	NT\$4488	IC-9095	95-115mm	NT\$7128
IC-9055	55-75mm	NT\$4488	IC-9115	115-135mm	NT\$7128

### Digital Outside Caliper Gauge



Resolution 0.005mm/0.0002"

OC-9000E	0-20mm	NT\$6336	OC-9030E	30-50mm	NT\$8580
OC-9010E	10-30mm	NT\$6864	OC-9040E	40-60mm	NT\$8976
OC-9020E	20-40mm	NT\$8580			

### Digital Inside Caliper Gauge

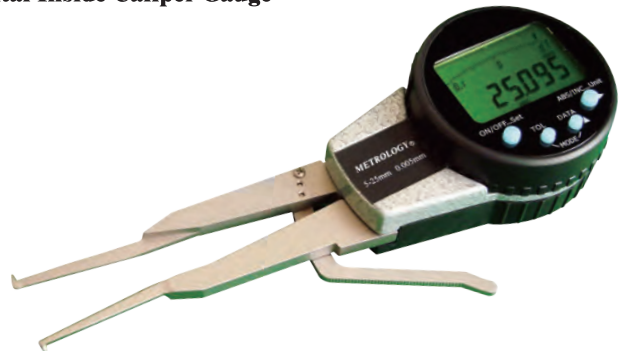

Resolution 0.005mm/0.0002"

IC-9005E	5-25mm	NT\$6336	IC-9030E	30-50mm	NT\$8580
IC-9010E	10-30mm	NT\$6864	IC-9040E	40-60mm	NT\$8976
IC-9020E	20-40mm	NT\$8580			

**Small Bore Gauge**



**Split Ball Probes**



Needle

Probe

Handle



Indicator (Optional)



Setting ring gauge

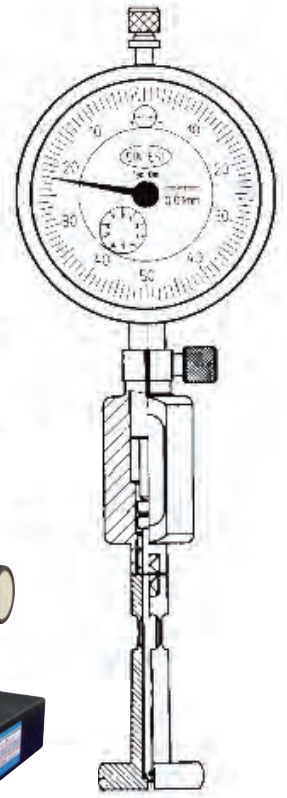

- \*Measuring range available: 0.47-41.10mm
- \*The whole set includes probe, needle, ring gauge, handle, wooden box
- \*The above components can be purchased individually
- \*For more information, please refer to the website

**Bore Gauge** Standard equipped with cylinder gauge drive handle, whole set of measuring rod or washer and box



Dial Indicator(Optional)

**Measuring Head**

**Insert Type**



6-10mm

BG-9001N  
BG-9002N  
BG-9003N



10-18mm

6-10mm NT\$4620  
10-18mm NT\$4488  
18-35mm NT\$3432



18-35mm

BG-9004N  
BG-9005N  
BG-9006N



35-50mm

35-50mm NT\$3432  
50-100mm NT\$3432  
50-160mm NT\$3432



50-160mm

BG-9007N  
BG-9008N  
BG-9009N  
BG-9010N

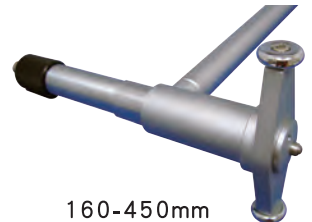

160-450mm

160-250mm NT\$4620  
250-450mm NT\$5280  
250-600mm NT\$5544  
400-800mm NT\$6468

**Measuring Head**

**Thread Type**



35-50mm

BG-9035S NT\$3432



50-100mm

BG-9050S NT\$3432

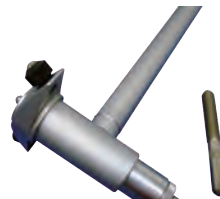

100-250mm

BG-9100S NT\$4620

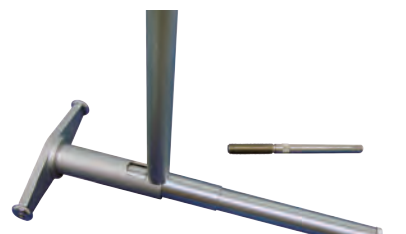

250-450mm

BG-9250S NT\$5280



### Dial Thickness Gauge



Deep throat  
30mm

Graduation 0.01mm  
DT-9003 0-10mm NT\$2112



Deep throat  
30mm

Graduation 0.01mm  
DT-9000TU 0-10mm NT\$2772



Deep throat  
120mm

Graduation 0.01mm  
DT-9004 0-10mm NT\$4224

### Digital Dial Thickness Gauge



ET-9010HN

Deep throat  
30mm

Resolution 0.01mm/0.0005"  
ET-9010 0-10mm NT\$6600  
Resolution 0.001mm/0.00005"  
ET-9010HN 0-10mm NT\$4488



ET-9010H

Deep throat  
30mm

Resolution 0.01mm/0.0005"  
ET-9010L 0-10mm NT\$7788  
Resolution 0.001mm/0.00005"  
ET-9010H 0-10mm NT\$9504

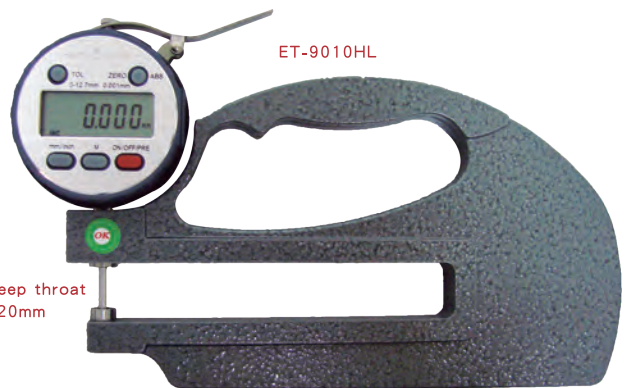

ET-9010HL

Deep throat  
120mm

Resolution 0.001mm/0.00005"  
ET-9010HL 0-10mm NT\$11088

### Dial Thickness Gauge

**Interchangeable  
anvil**



Deep throat  
30mm

Graduation 0.01mm  
DT-9001GI 0-10mm NT\$4620



Deep throat  
62.5mm

DT-9002GI 0-10mm NT\$5412

### Digital Dial Thickness Gauge

**Interchangeable  
anvil**



Deep throat  
30mm

Resolution 0.01mm/0.0005"  
ET-9001GI 0-10mm NT\$8184



Deep throat  
62.5mm

ET-9002GI 0-10mm NT\$9372

### Dial Thickness Gauge



Graduation 0.001mm  
DT-9001H 0-1mm NT\$4752



Graduation 0.01mm  
DT-9025 0-25mm NT\$5412

### Digital Dial Thickness Gauge

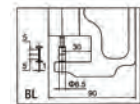

**Blade**

ET-9000BL NT\$11616



**Tube**

ET-9000TU NT\$11616

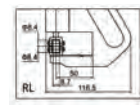

**Roller**

ET-9000RL NT\$11616



ET-9000BL

Resolution 0.005mm/0.0002"  
Measuring Range 0-10mm

**Dial Height Gauge**

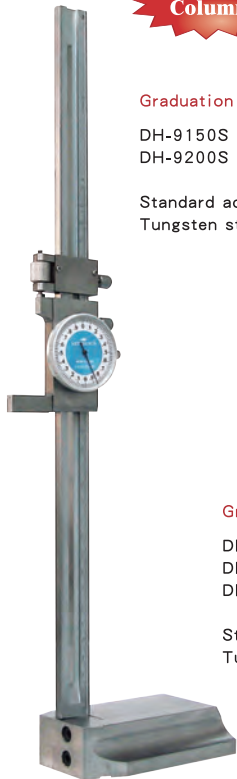

**Single Column**

Graduation 0.02mm  
 DH-9150S 0-150mm NT\$5907  
 DH-9200S 0-200mm NT\$6110

Standard accessories  
 Tungsten steel scriber & holder

**Double Columns**

Graduation 0.01mm  
 DH-9300D 0-300mm NT\$8910  
 DH-9450D 0-450mm NT\$13847  
 DH-9600D 0-600mm NT\$16129

Standard accessories  
 Tungsten steel scriber & holder



**Height Gauge Accessories**

**Rectangular Clamp**



HG-S 76\*6\*8mm NT\$660



HG-D 76\*9\*9mm NT\$660

**Tungsten Steel Scriber**



HG-DS NT\$924



HG-DE NT\$924



HG-ES NT\$924

**Scriber Holder**

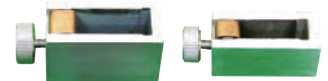

HG-SH NT\$660

**Digital Height Gauge**

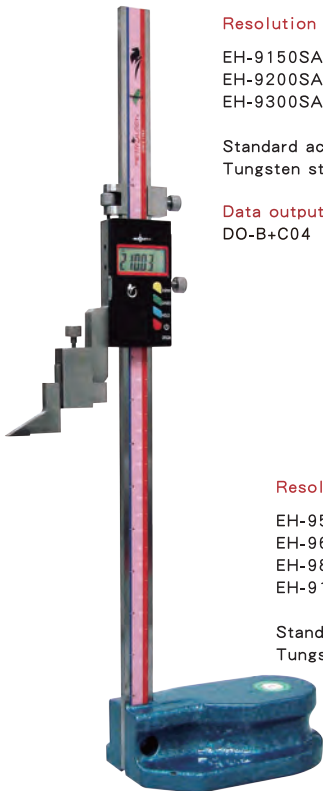

**Single Column**

Resolution 0.01mm/0.0005"  
 EH-9150SA 0-150mm NT\$5544  
 EH-9200SA 0-200mm NT\$6600  
 EH-9300SA 0-300mm NT\$8976

Standard accessories  
 Tungsten steel scriber & holder

Data output link  
 DO-B+C04 NT\$3036

**Single Column**

Resolution 0.01mm/0.0005"  
 EH-9500S 0-500mm NT\$17556  
 EH-9600S 0-600mm NT\$21912  
 EH-9800S 0-800mm NT\$23100  
 EH-91000S 0-1000mm NT\$31944

Standard accessories  
 Tungsten steel scriber & holder



**Double Columns**

Resolution 0.01mm/0.0005"  
 EH-9300D 0-300mm NT\$14536  
 EH-9450D 0-450mm NT\$18333  
 EH-9600D 0-600mm NT\$22407

Standard accessories  
 Tungsten steel scriber & holder





### Gauge Blocks (Sets)



**Harden  
steel**

GB-9122-0	122pcs/0	NT\$38635
GB-9122-1	122pcs/1	NT\$23735
GB-9122-2	122pcs/2	NT\$14111
GB-9112-0	112pcs/0	NT\$35464
GB-9112-1	112pcs/1	NT\$21795
GB-9112-2	112pcs/2	NT\$12961
GB-9103-0	103pcs/0	NT\$28413
GB-9103-1	103pcs/1	NT\$17464
GB-9103-2	103pcs/2	NT\$11032
GB-9087-0	87pcs/0	NT\$23631
GB-9087-1	87pcs/1	NT\$14518
GB-9087-2	87pcs/2	NT\$9083
GB-9047-0	47pcs/0	NT\$14466
GB-9047-1	47pcs/1	NT\$9096
GB-9047-2	47pcs/2	NT\$5769
GB-9038-0	38pcs/0	NT\$12994
GB-9038-1	38pcs/1	NT\$8004
GB-9038-2	38pcs/2	NT\$5146
GB-9020-0	20pcs/0	NT\$24567
GB-9020-1	20pcs/1	NT\$17914
GB-9010-0	10pcs/0	NT\$6185
GB-9010-1	10pcs/1	NT\$5648
GB-9009-0	9pcs/0	NT\$5856
GB-9009-1	9pcs/1	NT\$4453



**Tungsten  
steel**

GB-T9122-0	122pcs/0	NT\$82294
GB-T9122-1	122pcs/1	NT\$65142
GB-T9122-2	122pcs/2	NT\$58732
GB-T9112-0	112pcs/0	NT\$75364
GB-T9112-1	112pcs/1	NT\$59771
GB-T9112-2	112pcs/2	NT\$54401
GB-T9103-0	103pcs/0	NT\$71033
GB-T9103-1	103pcs/1	NT\$54574
GB-T9103-2	103pcs/2	NT\$49030
GB-T9087-0	87pcs/0	NT\$64969
GB-T9087-1	87pcs/1	NT\$50416
GB-T9087-2	87pcs/2	NT\$45392
GB-T9047-0	47pcs/0	NT\$50589
GB-T9047-1	47pcs/1	NT\$43139
GB-T9047-2	47pcs/2	NT\$37769
GB-T9038-0	38pcs/0	NT\$42446
GB-T9038-1	38pcs/1	NT\$37249
GB-T9038-2	38pcs/2	NT\$32051
GB-T9010-0	10pcs/0	NT\$17602
GB-T9010-1	10pcs/1	NT\$14588
GB-T9009-0	9pcs/0	NT\$13652
GB-T9009-1	9pcs/1	NT\$11469



**Ceramics**

GB-C9122-0	122pcs/0	NT\$176253
GB-C9122-1	122pcs/1	NT\$146289
GB-C9112-0	112pcs/0	NT\$155463
GB-C9112-1	112pcs/1	NT\$129014
GB-C9103-0	103pcs/0	NT\$144260
GB-C9103-1	103pcs/1	NT\$119741
GB-C9087-0	87pcs/0	NT\$125763
GB-C9087-1	87pcs/1	NT\$104379
GB-C9047-0	47pcs/0	NT\$76082
GB-C9047-1	47pcs/1	NT\$63162
GB-C9038-0	38pcs/0	NT\$69680
GB-C9038-1	38pcs/1	NT\$55275
GB-C9011-0	11pcs/0	NT\$13094
GB-C9011-1	11pcs/1	NT\$10138
GB-C9010-0	10pcs/0	NT\$21137
GB-C9010-1	10pcs/1	NT\$17556

Accuracy: according to DIN 861/ ISO 3650 standard Full set with JCC calibration report

### Gauge Block (Individual)



**Harden  
steel**

GB-03-1.0	0.3-1.0mm/step 0.1mm
GB-1.0005	1.0005mm
GB-1.001-1.009	1.001-1.009mm/step 0.001mm
GB-1.01-1.49	1.01-1.49mm/step 0.01mm
GB-1.60-1.90	1.60-1.90mm/step 0.1mm
GB-0.5-24.5	0.5-24.5mm/step 0.5mm
GB-30-100	30-100mm/step 10mm
GB-25-75	25-75mm/step 25mm

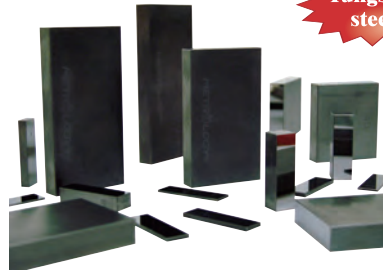

**Tungsten  
steel**

GB-T0.5	0.5mm
GB-T1.0	1.0mm
GB-T1.0005	1.0005mm
GB-T1.001-1.009	1.001-1.009mm/step 0.001mm
GB-T1.01-1.49	1.01-1.49mm/step 0.01mm
GB-T1.60-1.90	1.60-1.90mm/step 0.1mm
GB-T0.5-24.5	0.5-24.5mm/step 0.5mm
GB-T30-100	30-100mm/step 10mm
GB-T25-75	25-75mm/step 25mm



**Ceramics**

GB-C0.5	0.5mm
GB-C1.0	1.0mm
GB-C1.0005	1.0005mm
GB-C1.001-1.009	1.001-1.009mm/step 0.001mm
GB-C1.01-1.49	1.01-1.49mm/step 0.01mm
GB-C1.60-1.90	1.60-1.90mm/step 0.1mm
GB-C0.5-24.5	0.5-24.5mm/step 0.5mm
GB-C30-100	30-100mm/step 10mm
GB-C25-75	25-75mm/step 25mm

Accuracy: according to DIN 861/ ISO 3650 standard Each individual with JCC calibration report \* The above is only available for 0 and 1 grades

### Gauge Block



**Specially for outside  
micrometer**

Harden steel		Ceramics	
GB-9012-0	NT\$9200	GB-C9012-0	NT\$41147
GB-9012-1	NT\$6566	GB-C9012-1	NT\$37682
Spec. 2.5 / 5.1 / 7.7 / 10.3 / 12.9 / 15 / 17.6 / 20.2 / 22.8 / 25 / 50 / 75 mm			



**Long  
Gauge Block**

Material:  
Harden steel

GB-908S-0	NT\$17360	GB-908S-1	NT\$12855	GB-908S-2	NT\$9823
Spec. 25 / 50 / 75 / 100 / 125 / 150 / 175 / 200 mm					
GB-908M-0	NT\$45842	GB-908M-1	NT\$27841	GB-908M-2	NT\$19647
Spec. 125 / 150 / 175 / 200 / 250 / 300 / 400 / 500 mm					
GB-905L-0	NT\$172817	GB-905L-1	NT\$106427	GB-905L-2	NT\$73683
Spec. 600 / 700 / 800 / 900 / 1000 mm Available in a single piece					

**Gauge Block Sets (Imperial)**



**Hardened steel**

GB-90811-0	81pcs/0	NT\$19404
GB-90811-1	81pcs/1	NT\$12276
GB-90811-2	81pcs/2	NT\$8184
GB-90361-0	36pcs/0	NT\$9768
GB-90361-1	36pcs/1	NT\$6600
GB-90361-2	36pcs/2	NT\$4752



**Tungsten steel**

GB-T90811-0	81pcs/0	NT\$74084
GB-T90811-1	81pcs/1	NT\$49116
GB-T90811-2	81pcs/2	NT\$47741
GB-T90361-0	36pcs/0	NT\$36608
GB-T90361-1	36pcs/1	NT\$30288
GB-T90361-2	36pcs/2	NT\$26425



**Ceramics**

GB-C90811-0	81pcs/0	NT\$116985
GB-C90811-1	81pcs/1	NT\$99446
GB-C90361-0	36pcs/0	NT\$78392
GB-C90361-1	36pcs/1	NT\$66677

Accuracy: According to ASME B89.1.9-2002 Standard Full set with the calibration report of JCC (ISO 17025)

**Pin gauge (Sets)**

Step 0.01mm or 0.02mm



**Bearing steel**

PG-9001N	0.20-0.50	NT\$4673	PG-9021N	10.01-10.50	NT\$8910
PG-9002N	0.51-1.00	NT\$6171	PG-9022N	10.51-11.00	NT\$8910
PG-9003N	1.01-1.50	NT\$6171	PG-9023N	11.01-11.50	NT\$8910
PG-9004N	1.51-2.00	NT\$6171	PG-9024N	11.51-12.00	NT\$8910
PG-9005N	2.01-2.50	NT\$6171	PG-9025N	12.01-12.50	NT\$8910
PG-9006N	2.51-3.00	NT\$6171	PG-9026N	12.51-13.00	NT\$8910
PG-9007N	3.01-3.50	NT\$6171	PG-9027N	13.01-13.50	NT\$12474
PG-9008N	3.51-4.00	NT\$6171	PG-9028N	13.51-14.00	NT\$12474
PG-9009N	4.01-4.50	NT\$6171	PG-9029N	14.01-14.50	NT\$12474
PG-9010N	4.51-5.00	NT\$6171	PG-9030N	14.51-15.00	NT\$12474
PG-9011N	5.01-5.50	NT\$6171	PG-9031N	15.01-15.50	NT\$17028
PG-9012N	5.51-6.00	NT\$6171	PG-9032N	15.51-16.00	NT\$17028
PG-9013N	6.01-6.50	NT\$7293	PG-9033N	16.01-16.50	NT\$17028
PG-9014N	6.51-7.00	NT\$7293	PG-9034N	16.51-17.00	NT\$17028
PG-9015N	7.01-7.50	NT\$7293	PG-9035N	17.01-17.50	NT\$17028
PG-9016N	7.51-8.00	NT\$7293	PG-9036N	17.51-18.00	NT\$17028
PG-9017N	8.01-8.50	NT\$7293	PG-9037N	18.01-18.50	NT\$17028
PG-9018N	8.51-9.00	NT\$7293	PG-9038N	18.51-19.00	NT\$17028
PG-9019N	9.01-9.50	NT\$7293	PG-9039N	19.01-19.50	NT\$17028
PG-9020N	9.51-10.00	NT\$7293	PG-9040N	19.51-20.00	NT\$17028

With plastic & wooden case(0.2-6.0mm) Without plastic case(Over 6.0mm)  
Calibration report (Additional charge)  
Custom sizes and accuracy requirements available

**Hi-Accuracy Pin gauge (Sets)**

Step 0.01mm or 0.02mm



**Tool steel**

**Tungsten steel**

PG-9000H	0.10-0.20	NT\$6358	PG-9000T	0.10-0.20	NT\$17318
PG-9001H	0.21-0.50	NT\$9530	PG-9001T	0.21-0.50	NT\$35904
PG-9002H	0.51-1.00	NT\$10659	PG-9002T	0.51-1.00	NT\$24816
PG-9003H	1.01-1.50	NT\$7524	PG-9003T	1.01-1.50	NT\$24816
PG-9004H	1.51-2.00	NT\$7524	PG-9004T	1.51-2.00	NT\$24816
PG-9005H	2.01-2.50	NT\$7524	PG-9005T	2.01-2.50	NT\$24816
PG-9006H	2.51-3.00	NT\$7524	PG-9006T	2.51-3.00	NT\$24816
PG-9007H	3.01-3.50	NT\$7524	PG-9007T	3.01-3.50	NT\$24816
PG-9008H	3.51-4.00	NT\$7524	PG-9008T	3.51-4.00	NT\$24816
PG-9009H	4.01-4.50	NT\$7524	PG-9009T	4.01-4.50	NT\$32736
PG-9010H	4.51-5.00	NT\$7524	PG-9010T	4.51-5.00	NT\$32736
PG-9011H	5.01-5.50	NT\$7524	PG-9011T	5.01-5.50	NT\$38016
PG-9012H	5.51-6.00	NT\$7524	PG-9012T	5.51-6.00	NT\$38016
PG-9013H	6.01-6.50	NT\$9092	PG-9013T	6.01-6.50	NT\$43296
PG-9014H	6.51-7.00	NT\$9092	PG-9014T	6.51-7.00	NT\$43296
PG-9015H	7.01-7.50	NT\$9092	PG-9015T	7.01-7.50	NT\$51216
PG-9016H	7.51-8.00	NT\$9092	PG-9016T	7.51-8.00	NT\$51216
PG-9017H	8.01-8.50	NT\$9092	PG-9017T	8.01-8.50	NT\$56496
PG-9018H	8.51-9.00	NT\$9092	PG-9018T	8.51-9.00	NT\$56496
PG-9019H	9.01-9.50	NT\$9092	PG-9019T	9.01-9.50	NT\$61776
PG-9020H	9.51-10.00	NT\$9092	PG-9020T	9.51-10.00	NT\$61776

Each pin gauge with plastic case and full case  
Calibration report (Additional charge)  
Custom sizes and accuracy requirements available

**Hi-Accuracy Pin gauge (Individual)**

Step 0.01mm

0.10-0.30mm	NT\$2492
0.31-0.50mm	NT\$1193
0.51-1.00mm	NT\$771
1.01-3.00mm	NT\$581
3.01-4.00mm	NT\$771
4.01-5.00mm	NT\$866
5.01-6.00mm	NT\$1035
6.01-7.00mm	NT\$1214
7.01-8.00mm	NT\$1426
8.01-9.00mm	NT\$1552
9.01-10.00mm	NT\$1668

**Tool steel**

Accuracy ±0.001mm

0.10-0.30mm	NT\$1082
0.31-0.50mm	NT\$581
0.51-1.00mm	NT\$502
1.01-7.00mm	NT\$396
7.01-10.00mm	NT\$502

**Tungsten steel**

Accuracy ±0.001mm

**Ceramics**

Accuracy ±0.001mm

1.00-2.00mm	NT\$813
2.01-3.00mm	NT\$950
3.01-4.00mm	NT\$1098
4.01-5.00mm	NT\$1193
5.01-6.00mm	NT\$1288
6.01-7.00mm	NT\$1426
7.01-8.00mm	NT\$1573
8.01-9.00mm	NT\$1668
9.01-10.00mm	NT\$1764

Each pin gauge with plastic case  
Custom sizes and accuracy requirements available

**Pin Gauge (Individual)**

Step 0.01mm



**Bearing steel**

Accuracy ±0.003mm

0.10-0.20mm	NT\$568
0.21-0.50mm	NT\$461
0.51-1.00mm	NT\$342
1.01-6.00mm	NT\$267
6.01-10.00mm	NT\$342

Accuracy ±0.004mm

10.01-13.00mm	NT\$528
13.01-15.00mm	NT\$660
15.01-20.00mm	NT\$805

**Go & No Go gauge**



Size, Tolerance, Accuracy, Material

Material: Bearing steel, Alloy steel, Tool steel, Tungsten carbide, requirements available.  
Specifications: custom size, style, material, hardness, accuracy requirements available.



### Micrometer Standard Bar



**Flat measuring anvil type**

**Spherical measuring anvil type**

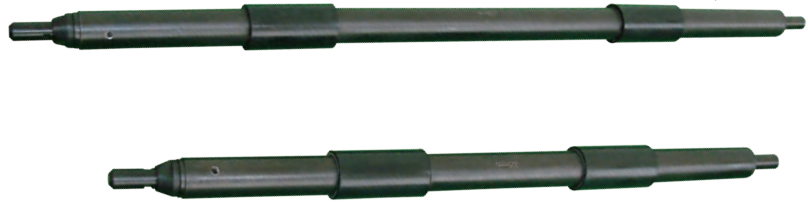

SB-9025	L:25mm	NT\$237
SB-9050	L:50mm	NT\$277
SB-9075	L:75mm	NT\$353
SB-9100	L:100mm	NT\$448
SB-9125	L:125mm	NT\$605
SB-9150	L:150mm	NT\$623
SB-9175	L:175mm	NT\$723
SB-9200	L:200mm	NT\$832
SB-9225	L:225mm	NT\$923
SB-9250	L:250mm	NT\$1062
SB-9275	L:275mm	NT\$1155

SB-9300	L:300mm	NT\$2269
SB-9325	L:325mm	NT\$2269
SB-9350	L:350mm	NT\$2719
SB-9375	L:375mm	NT\$2269
SB-9400	L:400mm	NT\$2719
SB-9425	L:425mm	NT\$2406
SB-9450	L:450mm	NT\$2883
SB-9475	L:475mm	NT\$2406
SB-9500	L:500mm	NT\$2883
SB-9525	L:525mm	NT\$2960
SB-9575	L:575mm	NT\$2960

SB-9625	L:625mm	NT\$3571
SB-9675	L:675mm	NT\$3571
SB-9725	L:725mm	NT\$3978
SB-9775	L:775mm	NT\$3978
SB-9825	L:825mm	NT\$4579
SB-9875	L:875mm	NT\$4579
SB-9925	L:925mm	NT\$5551
SB-9975	L:975mm	NT\$5551
SB-91050	L:1050mm	NT\$7529
SB-91150	L:1150mm	NT\$7529

### Ring Gauge

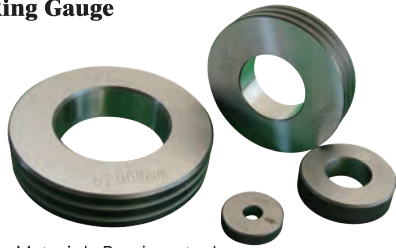

Material: Bearing steel

0.50-1.00mm	NT\$2283	65.00-79.00mm	NT\$4088	190.00-199.00mm	NT\$16476
1.10-3.90mm	NT\$1752	80.00-99.00mm	NT\$5440	200.00-229.00mm	NT\$17339
4.00-5.90mm	NT\$1136	100.00-109.00mm	NT\$7800	230.00-259.00mm	NT\$22992
6.00-9.00mm	NT\$1340	110.00-119.00mm	NT\$8760	260.00-309.00mm	NT\$29221
10.00-13.00mm	NT\$1340	120.00-129.00mm	NT\$9733	310.00-359.00mm	NT\$37501
14.00-17.00mm	NT\$1544	130.00-139.00mm	NT\$10524	360.00-409.00mm	NT\$51133
18.00-23.00mm	NT\$1768	140.00-149.00mm	NT\$11307	410.00-459.00mm	NT\$68180
24.00-29.00mm	NT\$2104	150.00-159.00mm	NT\$11947	460.00-500.00mm	NT\$73092
30.00-39.00mm	NT\$2416	160.00-169.00mm	NT\$13645	501.00-550.00mm	NT\$82500
40.00-49.00mm	NT\$2808	170.00-179.00mm	NT\$14024	551.00-600.00mm	NT\$92812
50.00-64.00mm	NT\$3200	180.00-189.00mm	NT\$15587		

Requirement of specific size, material, type and accuracy provided by custom order  
With the calibration report of JCC (ISO / IEC 17025)

### Thread Plug Gauge



ISO Metric Thread Plug Gauge	M2-M200
ISO Metric Thread Ring Gauge	M2-M200
JIS Metric Thread Ring Gauge	M2-M200
JIS Metric Thread Plug Gauge	M2-M200
Unified Thread Plug Gauge	NO.4-4"
Unified Thread Ring Gauge	NO.4-4"
NPT Taper Thread Plug Gauge	1/16"-8"
NPT Taper Thread Ring Gauge	1/16"-8"
NPTF Taper Thread Plug Gauge	1-1/16"-4
NPTF Taper Thread Ring Gauge	1-1/16"-4

### Thread Ring Gauge

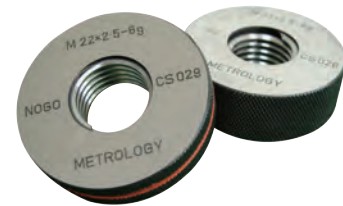

### 3-Wire Thread Gauge



Choose according to your needs  $\Phi 6.35\text{mm}$ 、 $6.5\text{mm}$ 、 $8\text{mm}$



TW-0.170	NT\$5748	TW-0.290	NT\$5748
TW-0.195	NT\$5748	TW-0.335	NT\$5748
TW-0.220	NT\$5748	TW-0.390	NT\$5748
TW-0.250	NT\$5748	TW-0.455	NT\$5748

TW-0.530	NT\$5748
TW-0.620	NT\$5748
TW-0.725	NT\$5748
TW-0.895	NT\$5748

TW-1.100	NT\$5748
TW-1.350	NT\$5748
TW-1.650	NT\$5748
TW-2.050	NT\$5748

TW-2.550	NT\$5748
TW-3.200	NT\$5748
TW-9018S(18pair/set)	
	NT\$106148

### Thread Pitch Diameter Comparator



Graduation 0.01mm		
PD-9001	2-30mm	NT\$21780
PD-9002	30-70mm	NT\$21780

### Thread Length Measuring Gauge

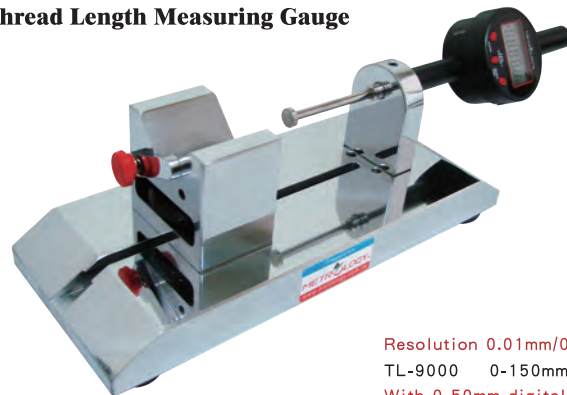

Resolution 0.01mm/0.0005"		
TL-9000	0-150mm	NT\$37699
With 0-50mm digital dial gauge		

**Spirit Level**



**Horizontal**

Sensitivity 0.02mm / M  
 LE-9150H L:150mm NT\$4488  
 LE-9200H L:200mm NT\$5148  
 LE-9300H L:300mm NT\$5940



**Square**

Sensitivity 0.02mm / M  
 LE-9150S L:150\*150mm NT\$5544  
 LE-9200S L:200\*200mm NT\$6204  
 LE-9300S L:300\*300mm NT\$9466

**Universal Bevel Protractor**

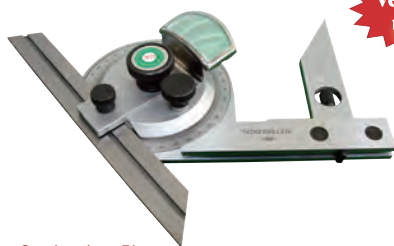

**Vernier type**

Graduation 5'  
 UA-9000 0°-360° NT\$3749



**Dial type**

Graduation 5'  
 UA-9000D 4\*90° NT\$4695



**Digital type**

Resolution 1'/0.01°  
 UA-9000E 0°-360° NT\$13728

**Angle Finder**

Resolution 0.1°  
 AF-A1 0°-180° NT\$

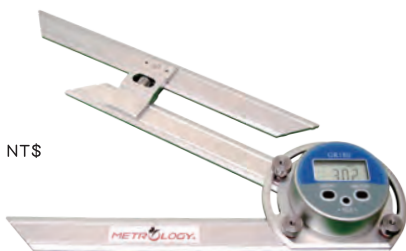

Resolution 0.05°  
 AF-A2 0°-360° NT\$3300

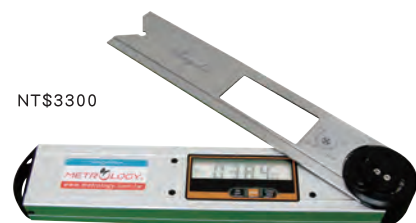

**Digital Protractor**



Resolution 0.1°  
 PT-A1 0°-180° NT\$3168 PT-A2 0°-180° (With magnet) NT\$3432

**Bevel Box**



Resolution 0.05°  
 BB-digilevel 4\*90° NT\$2112



**Optical Parallel Flats**



GB-OPF30N Φ30\*12 NT\$4858  
 GB-OPF30H Φ30\*12(Hi-Accracy) NT\$5491

**Optical Flats**

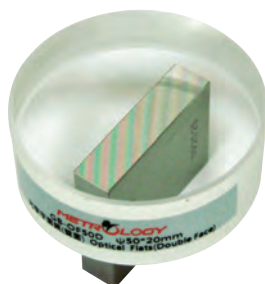

GB-OF45S Φ45\*15 Single Face NT\$4858  
 GB-OF45D Φ45\*15 Double Face NT\$6230  
 GB-OF50S Φ50\*20 Single Face NT\$7603  
 GB-OF50D Φ50\*20 Double Face NT\$12778  
 GB-OF60S Φ60\*20 Single Face NT\$7920  
 GB-OF60D Φ60\*20 Double Face NT\$13622  
 GB-OF75S Φ75\*20 Single Face NT\$14467  
 GB-OF75D Φ75\*20 Double Face NT\$29251

**Optical Parallel Sets**



GB-OP12S Φ30 (For0-25mm) NT\$16685  
 Thickness: 12/12.12/12.25/12.37mm 4PCS/set  
 GB-OP25S Φ30 (For25-50mm) NT\$19430  
 Thickness: 25/25.12/25.25/25.37mm 4PCS/set



### Roughness Comparison Specimens



RC-PG4 6 pcs/Plain Grinding NT\$2281



RC-TU3 6 pcs/Lathe Turning NT\$2281



RC-6SETS 30 pcs NT\$7128  
Horizontal Milling, Vertical Milling, Lathe Turning  
Plain Grinding, Flat Lapping, External Grinding

### Dial Center Finder



Finding external center

Graduation 0.005mm  
CF-9000 NT\$6204



Finding internal center

Full set with indicator. Straight feeler 3 pieces, curved feeler 3 pieces, center point feeler 1 piece, stopper bar 1 piece.

### Dial Crank Shank Gauge



Graduation 0.01mm

CS-9000



NT\$10296

60-500mm

Full set with indicator, measuring anvil & extension bar



### Telescoping Gauge



TG-9001	8-12.7mm	NT\$396
TG-9002	12.7-19mm	NT\$396
TG-9003	19-32mm	NT\$396
TG-9004	32-54mm	NT\$396
TG-9005	54-90mm	NT\$396
TG-9006	90-150mm	NT\$396
TG-9000S	8-150mm(sets)	NT\$2376

### Inverted Measuring Gauge

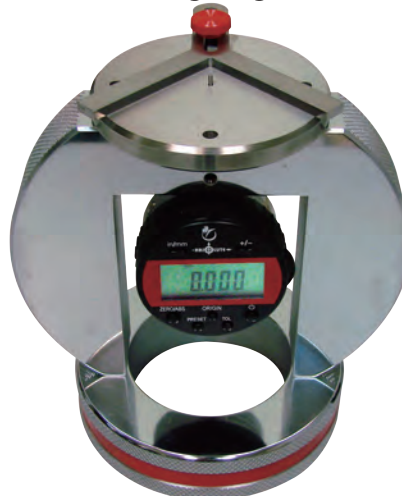

MG-9001	Φ95mm	NT\$32571
MG-9002	Φ150mm	NT\$41143

With 0-12.5mm/0.001mm digital indicator



**Bore Gauge Checkmaster**



Setter & base



Slide pressured locking device

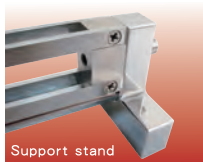

Support stand

Vertical setting

Horizontal setting



Vertical setting

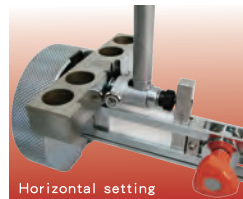

Horizontal setting

BGC-9200	0-200mm	NT\$24000
BGC-9300	0-300mm	NT\$30000
BGC-9600	0-600mm	NT\$36000

Must be used with gauge block(Optional)

**Z-axis Zero Setter**



Digital

Resolution 0.001mm/0.00005"  
Measuring Range 2mm  
Setting height 50mm

ZZS-9000D NT\$4224

New products pictures are for reference only



**Arc Radius Measuring Gauge**



Digital

Resolution 0.01mm/0.0005"  
Measuring Range R5-700mm

ARG-9000C NT\$10428

New products pictures are for reference only



**Concentricity Tester**

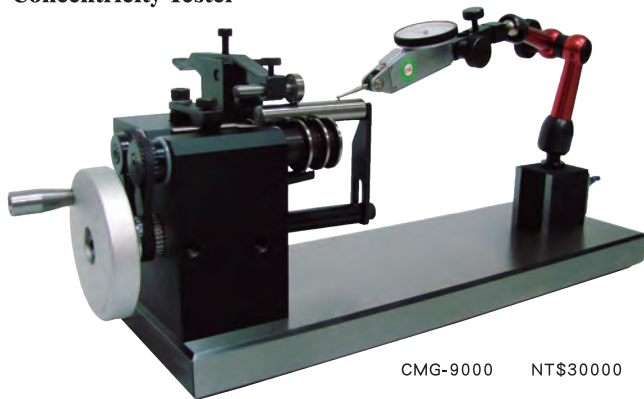

CMG-9000 NT\$30000



Constant pressure rolling bearing



Back stopper



Front stopper



Rotating handwheel and precision transmission



Measuring device with adjustable range



precision concentric roller sets



Example of measuring concentricity with indicator

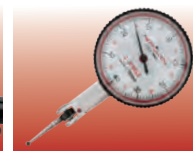

Precision level type dial indicator(Optional)

Measuring range: Diameter 3-35mm Length 5-150mm Cylindrical workpieces  
Material of measure roller: Hardened tool steel HRC58-62 Rotation accuracy  $\leq 3 \mu\text{m}$



# Granite Master Gauge

Grade : German DIN 876/00, JCC inspection report included

## Granite Surface Plate



GN-1010	100*100*50mm	NT\$1056
GN-2020	200*200*60mm	NT\$1985
GN-3030	300*300*80mm	NT\$2904
GN-3045	300*450*80mm	NT\$4224
GN-4560	450*600*100mm	NT\$7425
GN-5050	500*500*100mm	NT\$7425
GN-5080	500*800*100mm	NT\$11550
GN-6060	600*600*100mm	NT\$10725
GN-6090	600*900*100mm	NT\$14025
GN-75100	750*1000*150mm	NT\$26400
GN-90120	900*1200*150mm	NT\$42900
GN-100100	1000*1000*150mm	NT\$42900
GN-100150	1000*1500*200mm	NT\$74135
GN-100200	1000*2000*200mm	NT\$104247
GN-150150	1500*1500*200mm	NT\$138996
GN-150200	1500*2000*200mm	NT\$210804
GN-150300	1500*3000*300mm	NT\$391776
GN-200200	2000*2000*300mm	NT\$
GN-200300	2000*3000*300mm	NT\$
GN-200400	2000*4000*350mm	NT\$

## Steel Stands

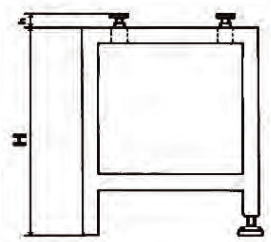
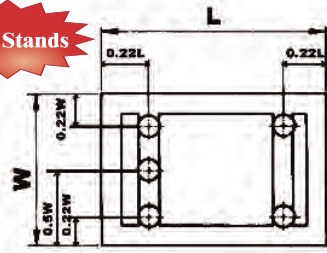

GN-S3030	300*300*700mm	NT\$4480
GN-S3045	300*450*700mm	NT\$5200
GN-S4560	450*600*700mm	NT\$6720
GN-S5050	500*500*700mm	NT\$6720
GN-S5080	500*800*700mm	NT\$7840
GN-S6060	600*600*700mm	NT\$6880
GN-S6090	600*900*700mm	NT\$7840
GN-S75100	750*1000*600mm	NT\$11840
GN-S90120	900*1200*600mm	NT\$13120
GN-S100100	1000*1000*600mm	NT\$12960
GN-S100150	1000*1500*600mm	NT\$17760
GN-S100200	1000*2000*500mm	NT\$20320
GN-S150150	1500*1500*500mm	NT\$35200
GN-S150200	1500*2000*500mm	NT\$
GN-S150300	1500*3000*400mm	NT\$
GN-S200200	2000*2000*400mm	NT\$
GN-S200300	2000*3000*400mm	NT\$
GN-S200400	2000*4000*300mm	NT\$

## Granite Surface Plate Cleaner



GN-CL0.1	100ml	NT\$198
GN-CL1.0	1000ml	NT\$1188



## Granite Tri-Square Master

GN-250T	250*160*40mm	NT\$5412
GN-300T	300*200*40mm	NT\$6996
GN-400T	400*250*40mm	NT\$8052
GN-630T	630*400*50mm	NT\$14784
GN-800T	800*500*60mm	NT\$22308
GN-1000T	1000*630*80mm	NT\$36960
GN-1500T	1500*1000*100mm	NT\$82500

## Granite Four Face Square Master



GN-200F	200*200*40mm	NT\$7392
GN-300F	300*300*40mm	NT\$9900
GN-400F	400*400*50mm	NT\$12408
GN-500F	500*500*50mm	NT\$18612
GN-600F	600*600*60mm	NT\$24816
GN-800F	800*800*70mm	NT\$49500
GN-1000F	1000*1000*100mm	NT\$78408

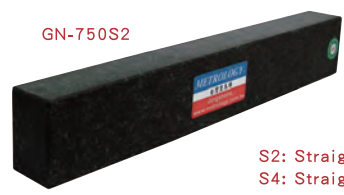

## Straight type Granite Straight Edge Master

S2: Straight type of two-faces machining  
S4: Straight type of four-faces machining

500*100*60mm	GN-500S2	NT\$8316	GN-500S4	NT\$9372
750*100*60mm	GN-750S2	NT\$9372	GN-750S4	NT\$10428
1000*120*60mm	GN-1000S2	NT\$12408	GN-1000S4	NT\$14520
1500*150*60mm	GN-1500S2	NT\$23760	GN-1500S4	NT\$26928
2000*200*80mm	GN-2000S2	NT\$36168	GN-2000S4	NT\$41316
2500*250*80mm	GN-2500S2	NT\$55704	GN-2500S4	NT\$61908
3000*250*100mm	GN-3000S2	NT\$82500	GN-3000S4	NT\$92928
4000*300*120mm	GN-4000S2	NT\$	GN-4000S4	NT\$

## I type Granite Straight Edge Master



GN-500I2	NT\$9372	GN-500I4	NT\$10428
GN-750I2	NT\$10428	GN-750I4	NT\$11352
GN-1000I2	NT\$14124	GN-1000I4	NT\$16104
GN-1500I2	NT\$25872	GN-1500I4	NT\$28908
GN-2000I2	NT\$39204	GN-2000I4	NT\$45408

I2: I type of two-faces machining  
I4: I type of four-faces machining

## Granite Parallel Master

GN-400P



2pcs/set

160*25*16mm	GN-160P2	NT\$4224	GN-160P4	NT\$5412
250*40*25mm	GN-250P2	NT\$6204	GN-250P4	NT\$7260
400*63*40mm	GN-400P2	NT\$9900	GN-400P4	NT\$12408
630*100*63mm	GN-630P2	NT\$18612	GN-630P4	NT\$23496

P2: Two-faces machining P4: Four-faces machining

## Granite V-Block Master

GN-1000V



2pcs/set

GN-60V	60*60*60mm	NT\$6204
GN-100V	100*100*80mm	NT\$9372
GN-160V	160*160*100mm	NT\$16500
GN-200V	200*200*120mm	NT\$29700
GN-300V	300*300*150mm	NT\$46200

**Granite Measuring Stand**

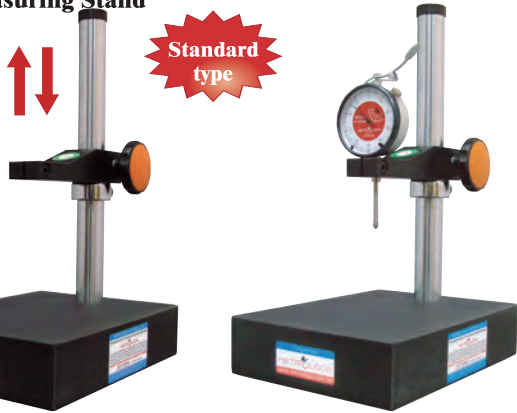

GN-MS2015N

GN-MS1515N	150*150*40mm	NT\$4356
GN-MS2015N	250*150*40mm	NT\$4884
GN-MS3020N	300*200*50mm	NT\$6468
GN-MS4530N	450*300*50mm	NT\$9240
GN-MS6045N	600*450*60mm	NT\$13200

Dial gauge (Optional)

**Granite Measuring Stand**

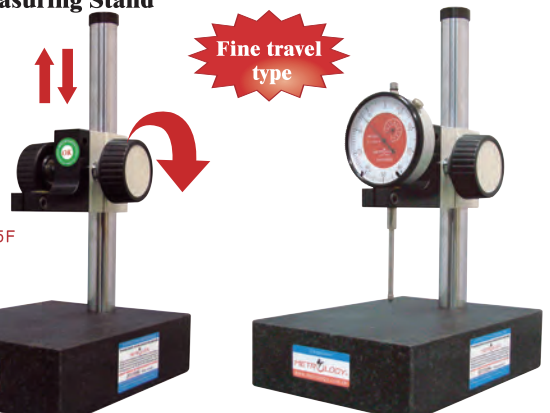

GN-MS2015F

GN-MS2015F	250*150*40mm	NT\$8052
GN-MS3020F	300*200*50mm	NT\$9636
GN-MS4530F	450*300*50mm	NT\$12408
GN-MS6045F	600*450*60mm	NT\$16368

Dial gauge (Optional)

**Granite Measuring Stand**



GN-MS2015A

GN-MS2015A	250*150*40mm	NT\$5940
GN-MS3020A	300*200*50mm	NT\$6600
GN-MS4530A	450*300*50mm	NT\$9240
GN-MS6045A	600*450*60mm	NT\$13200

Dial gauge (Optional)

**Granite Measuring Stand**



GN-MS2015U

GN-MS2015U	250*150*40mm	NT\$4356
GN-MS3020U	300*200*50mm	NT\$5544
GN-MS4530U	450*300*50mm	NT\$8184
GN-MS6045U	600*450*60mm	NT\$12012

Dial indicator (Optional)

**Granite Measuring Stand**

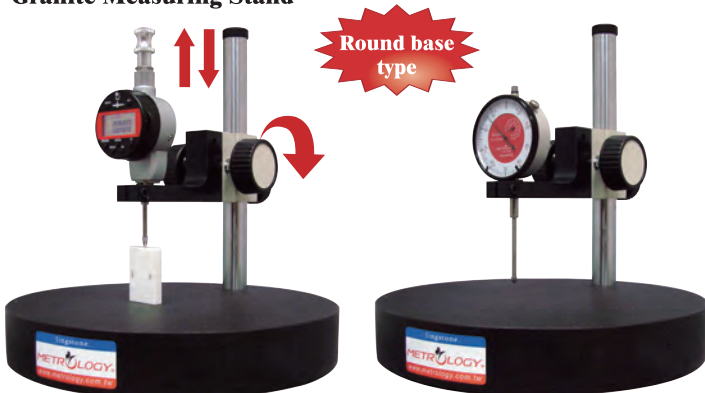

GN-MS300F Φ300\*T50mm NT\$14520

Dial gauge (Optional)

**Granite Measuring Stand**



GN-MS3020H 300\*200\*75mm NT\$17160

Dial gauge (Optional)

**Slide Guide Comparator**

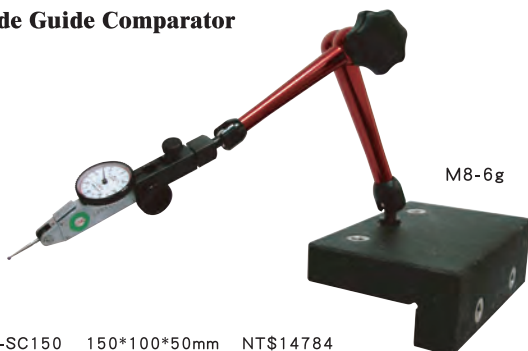

GN-SC150 150\*100\*50mm NT\$14784

\*The types and specs of universal arms and indicators are optional as per customer's requirements.





**Stereo Microscope**



**Binocular**

No illumination

OP-ZM1 7-45X NT\$12672



**Trinocular**

No illumination

OP-ZT1 7-45X NT\$15840



**Binocular**

Up & down adjustable light source

OP-ZM3 7-45X NT\$17741



**Trinocular**

OP-ZT3 7-45X NT\$20909

**Stereo Microscope**



**Binocular**

OP-ZM4 7-45X NT\$21120



**Trinocular**

Big plate  
L: 380\*250mm

OP-ZT4 7-45X NT\$24288

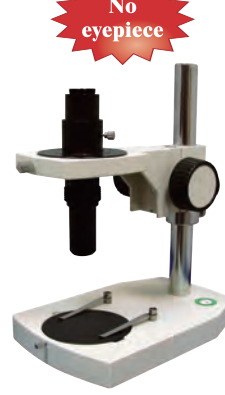

**No eyepiece**

OP-ZTX1 0.7-4.5X NT\$11642



**Single eyepiece**

OP-ZTS1 7-45X NT\$17094

**Single-eyepiece Stereo Microscope**

**HDMI Digital Microscope**



OP-ZTS6 7-45X NT\$

**3D Stereo Image Microscope**



OP-SM9000 3.3-147X NT\$93350



HDMI monitor(Optional)



OP-HDMI300 300X NT\$15734  
OP-HDMI500 500X NT\$21014  
500X with measuring software



OP-HDMI300H 300X NT\$24182  
OP-HDMI500H 500X NT\$29462  
500X with measuring software

**Trinocular Metallurgical Microscope**



**Normal**

OP-MM9002 X75\*Y50mm NT\$85958  
Magnification: 40X / 100X / 200X / 400X



**Big travel**

OP-MM9003 X250\*Y250mm NT\$142877  
Magnification: 40X / 100X / 200X / 400X



**Inverted**

OP-IM9000 X15\*Y15mm NT\$95040  
Magnification: 100X / 250X / 400X / 1000X

**Biological Microscope**



OP-BM9001(Binocular) X76\*Y52mm NT\$29462  
OP-BM9002(Trinocular) X76\*Y52mm NT\$31469  
Magnification: 40X / 100X / 400X / 1000X

**Tool Microscopes**



Resolution 0.001mm/0.00005"

OP-TMZ25 7-45X X25\*Y25 NT\$53750  
OP-TMZ50 7-45X X50\*Y50 NT\$66528

**Image Tool Microscopes**

Resolution 0.001mm/0.00005"



OP-ITMZ25 7-45X X25\*Y25 NT\$80890  
OP-ITMZ50 7-45X X50\*Y50 NT\$92928

**Optical accessories**

**Eyepiece**



OP-EL10 10X NT\$2772  
OP-EL10G 10X(Cross line) NT\$2640  
OP-EL15 15X NT\$2508  
OP-EL20 20X NT\$2640

**Objective lens**



OP-OL0.5 0.5X NT\$3168  
OP-OL1.5 1.5X NT\$3168  
OP-OL2.0 2.0X NT\$3802

**Color CCD**



OP-CCD 700TVL NT\$9425

**Illuminators**



OP-8W Circular fluorescent light NT\$1848

**Small vise**



OP-VS Clamp length: L18mm NT\$3062

**V-clamp**



OP-VC Clamp dia. Φ18mm NT\$2640

**Image capture units**



OP-IC With cable & software NT\$6970

**XY axis-measuring table**



OP-XY22 X50\*Y50mm NT\$21120

**X-Y stage**



OP-STAGE1 X75\*Y50mm(Flat plate) NT\$7075  
OP-STAGE2 X75\*Y50mm(Light unit) NT\$8659

**Cross-line generator**



OP-CG2 NT\$13094

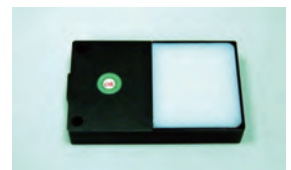

OP-LEDB 2"\*2" LED back light NT\$8026



OP-LED LED circular light NT\$4013



### Optical accessories

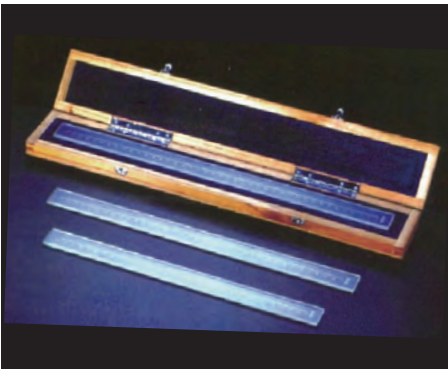

**Standard glass scale**

OP-SS4	100mm	NT\$6160
OP-SS6	150mm	NT\$7920
OP-SS8	200mm	NT\$9680
OP-SS10	250mm	NT\$11440
OP-SS12	300mm	NT\$13200
OP-SS16	400mm	NT\$15840
OP-SS20	500mm	NT\$19360
OP-SS24	600mm	NT\$21120
OP-SS28	700mm	NT\$22880
OP-SS32	800mm	NT\$24640
OP-SS36	900mm	NT\$26400
OP-SS40	1000mm	NT\$28160

**Reading glass scale**

OP-RS310	310mm	NT\$5350
OP-RS360	360mm	NT\$6054

**Standard glass checker**



OP-CP814 NT\$9504  
X:140mm Y:80mm

**High magnification calibration glass scale**

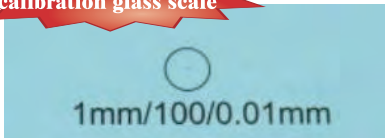

OP-HC1 75\*25\*1.8mm NT\$2244

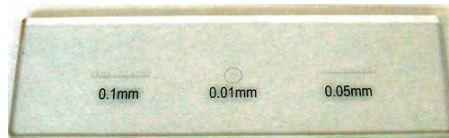

OP-HC10 75\*25\*1.8mm NT\$2904

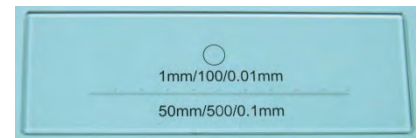

OP-HC50 75\*25\*1.8mm NT\$3432

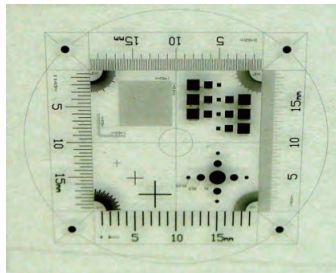

OP-HCM 42\*42\*1.8mm NT\$7260

**Linear scale**



OP-LS50	50mm	NT\$7603	OP-LS300	300mm	NT\$9158	OP-LS800	800mm	NT\$13248
OP-LS100	100mm	NT\$7891	OP-LS400	400mm	NT\$9792	OP-LS900	900mm	NT\$14803
OP-LS150	150mm	NT\$8064	OP-LS500	500mm	NT\$10598	OP-LS1000	1000mm	NT\$16358
OP-LS200	200mm	NT\$8294	OP-LS600	600mm	NT\$11693	OP-LS1500	1500mm	NT\$26093
OP-LS250	250mm	NT\$8698	OP-LS700	700mm	NT\$12442	OP-LS2000	2000mm	NT\$32717

Resolution 0.005mm > 0.001mm > 0.0005mm > 0.0001mm by requirement

**2D Microprocessor digital readout**



OP-ES2 Simple X-Y axis digital display NT\$8480  
OP-ES3 Simple X-Y-Z axis digital display NT\$10560

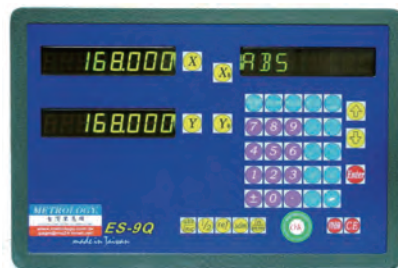

OP-ES92 X-Y axis 2D geometric measuring function NT\$14976



OP-ES93 X-Y-Z axis 2D geometric measuring function NT\$18432

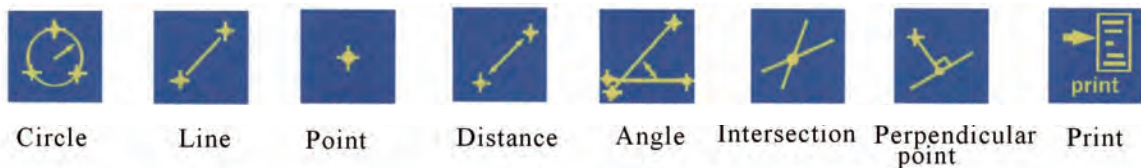

**HDMI Measuring Camera**



OP-HMC309M NT\$11405

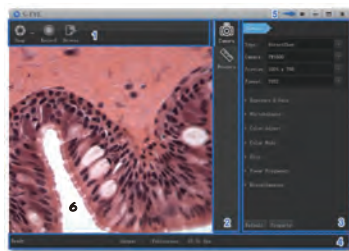

Software Interface:  
1. Toolbar 2. Camera and measurement  
3. Control panel 4. Status bar  
5. Main menu 6. Image window

Measuring software function:

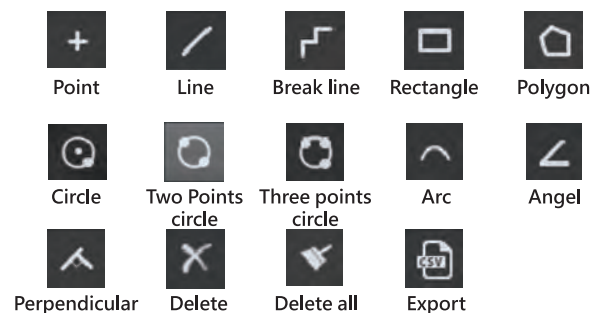

## Tower Outside Checker

TOC-X300

ISO The best tool of length calibration

TOC-X150 NT\$16629  
25-150mm / Step 25mm

TOC-X200 NT\$20743  
25-200mm / Step 25mm

TOC-X300 NT\$29726  
25-300mm / Step 25mm

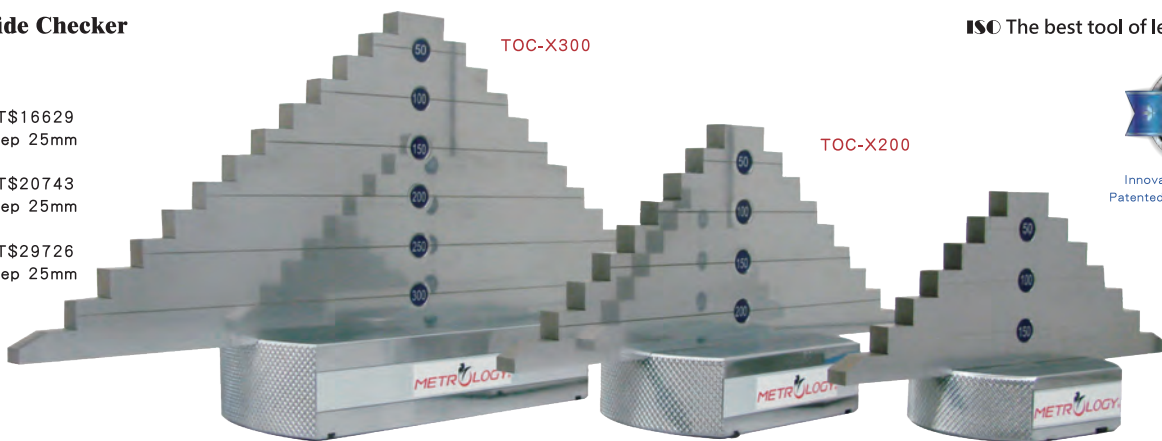

Innovation Design R&D  
Patented Technology Award

TOC-X150

Compliance with ISO/IEC 17025 measurement traceability and accredited calibration laboratory (JCC) calibration report. Minimum reading value 0.1um



## Cylinder Depth Checker

CDC-400D 5-400mm NT\$28080



Innovation Design R&D  
Patented Technology Award

Dial Depth gauge  
calibration & zero setting

Depth micrometer  
calibration & zero setting

Depth caliper  
calibration

Depth calibration  
of caliper



Outside accuracy  
calibration  
of any types of calipers



Zero setting and calibration  
of outside micrometers



Compliance with ISO/IEC 17025 measurement traceability and accredited calibration laboratory (JCC) calibration report. Minimum reading value 0.1um

## Surface Plate Repeat Checking Calibrator



Taiwan patent

German patent



PLA-9001 Diagonal L ≥ 150 ≤ 550 NT\$12343  
PLA-9002 Diagonal L ≥ 550 ≤ 1100 NT\$17143  
PLA-9003 Diagonal L ≥ 1100 ≤ 2200 NT\$20751  
PLA-9004 Diagonal L ≥ 2200 ≤ 3300 NT\$25714

Indicators are option for purchase depending on the requirements

## Checkmaster Gauge (Caliper Checker)

Height calibration  
of height gauges



CMG-9060

CMG-9030

Checkmaster Gauge can be placed vertically, horizontally, and on sides for calibrating outside, inside, and height. All calibration points are the same.



Outside calibration of calipers



Inside calibration of calipers

0-300mm CMG-9030 NT\$53486 CMG-9030C NT\$64183  
0-600mm CMG-9060 NT\$74414 CMG-9060C NT\$89297  
0-1000mm CMG-9100 NT\$126528 CMG-9100C NT\$154272

Compliance with ISO/IEC 17025 measurement traceability and accredited calibration laboratory (JCC) calibration report. Minimum reading value 0.1um C: Ceramic



### Checkmaster Gauge (Step Gauge)

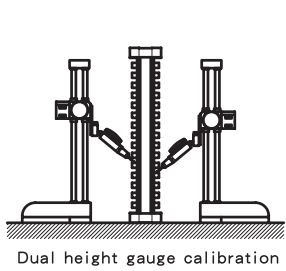

Dual height gauge calibration



Taiwan patent UN patent



Innovation Design R&D Patented Technology Award

CMG-9030T	0-320mm	NT\$102514
CMG-9060T	0-620mm	NT\$158585



Accuracy calibration

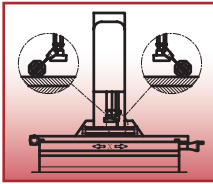

X-axis

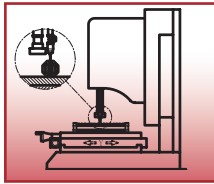

Y-axis

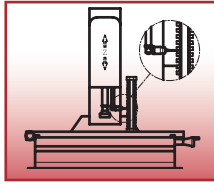

Z-axis

### Checkmaster Gauge (Step Gauge) ISO The best tool of length calibration



Taiwan invention patent German innovation patent



0-300mm	CMG-9030H	NT\$78943	C: Ceramic	CMG-9030HC	NT\$94731
0-600mm	CMG-9060H	NT\$121989		CMG-9060HC	NT\$146386
0-1000mm	CMG-9100H	NT\$205728		CMG-9100HC	NT\$250272

Can be place vertically, horizontally, and sides.  
Must be placed in the best temperature controlled environment within  $\leq \pm 1^\circ\text{C}$   
Optional: special ceramic measuring blocks hardness: >HV1200

Compliance with ISO/IEC 17025 measurement traceability and accredited calibration laboratory (JCC) calibration report. Minimum reading value 0.1um

### Electronic Dial & Gauge Calibrator

Resolution 0.001mm/0.00005"



Taiwan invention patent



German innovation patent

### Bore gauge calibration diagram

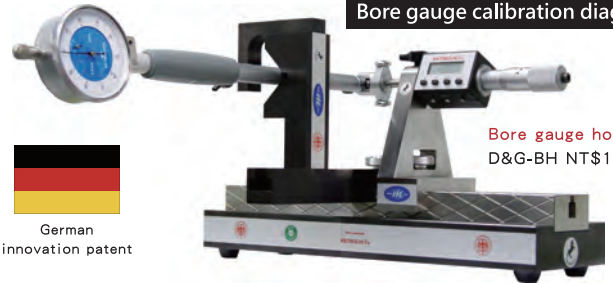

Bore gauge holder  
D&G-BH NT\$10080

D&G-9001(Chromed Steel) 0-25mm / 0-1" NT\$49029

D&G-9002(Tool Steel) 0-25mm / 0-1" NT\$75429

D&G-9003(Chromed Steel) 0-50mm / 0-2" NT\$60343

■ Outside diameter, thickness, length



■ Concentricity



■ Pin & plug gauge



■ Thread plug gauge



■ Dial indicator



■ Level-type indicator



### Hi-Accuracy Dial Indicator Calibrator

the calibration function of indicator \ lever type indicator and cylinder bore gauge.



### ISO The best tool of length calibration



Taiwan invention patent



German innovation patent

Resolution 0.0001mm/0.000005"  
D&G-9004 0-25mm / 0-1" NT\$342840

Nanotechnology Precision Length Measurement System



Innovation Design R&D Patented Technology Award



HDC-9025	0-25mm / 0-1"	NT\$214000
HDC-9050	0-50mm / 0-2"	NT\$256000
HDC-9100	0-100mm / 0-4"	NT\$300000

New products, pictures are for reference only

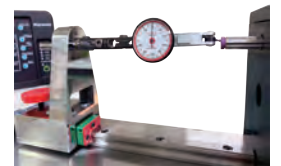

**Multi-functional Length Calibrator**

**Incredible calibration functions**



External calibration

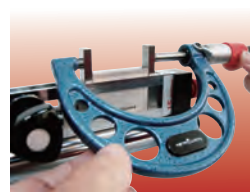

Internal calibration

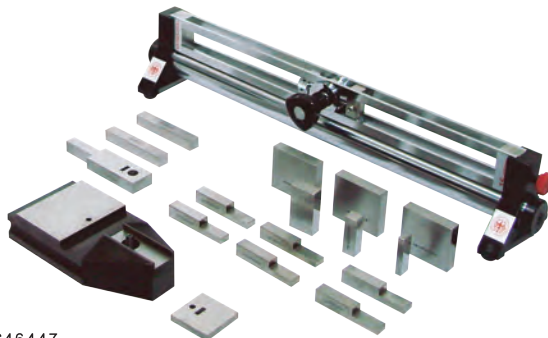
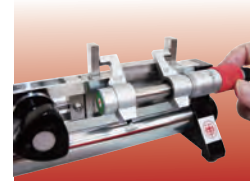
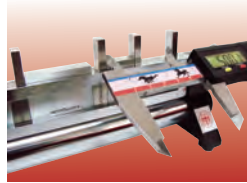
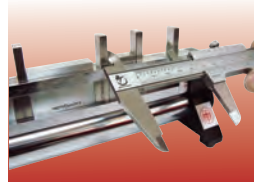

Taiwan invention patent



German innovation patent



United States invention patent

- LEN-9001 200mm NT\$46447
- LEN-9002 300mm NT\$48675
- LEN-9003 600mm NT\$60305
- LEN-9004 1000mm NT\$77791

Compliance with ISO/IEC 17025 measurement traceability and accredited calibration laboratory (JCC) calibration report.  
Minimum reading value 0.1um

To be used with standard gauge block

Calibration diagram

■ Depth micrometer calibration



■ Digital indicator calibration



■ Depth gage calibration



■ Depth calibration of caliper



■ Step calibration of caliper



■ Height gage calibration

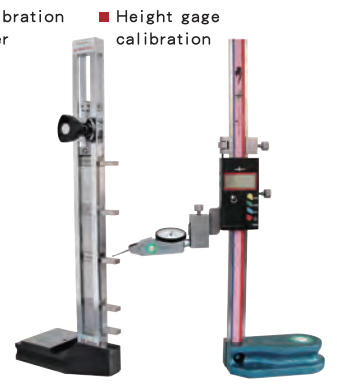

ISO The best tool of length calibration

**Bore Gage Setter**



Setting gauge  
LEN-BS1 NT\$9000



Horizontal setting and calibration

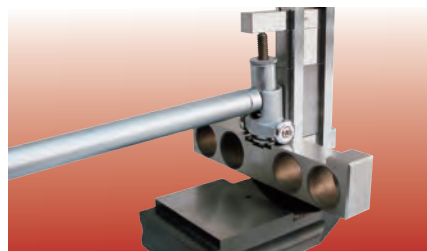

Vertical setting and calibration

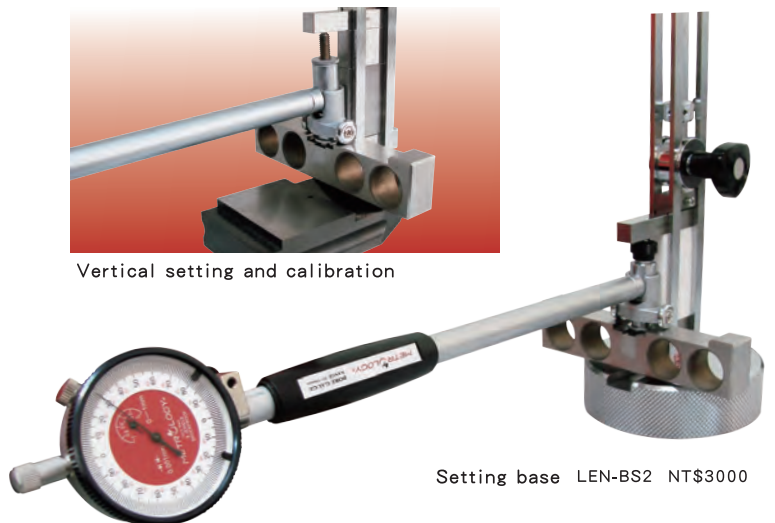

Setting base LEN-BS2 NT\$3000



**Universal Measuring & Calibration Instrument**

ISO The best tool of length calibration



Taiwan Patent



UN patent



China Patent



Innovation Research & Development Design  
Manufacture Assembly Inspection

**TRANSFORMERS**



Innovation Design R&D  
Patented Technology Award

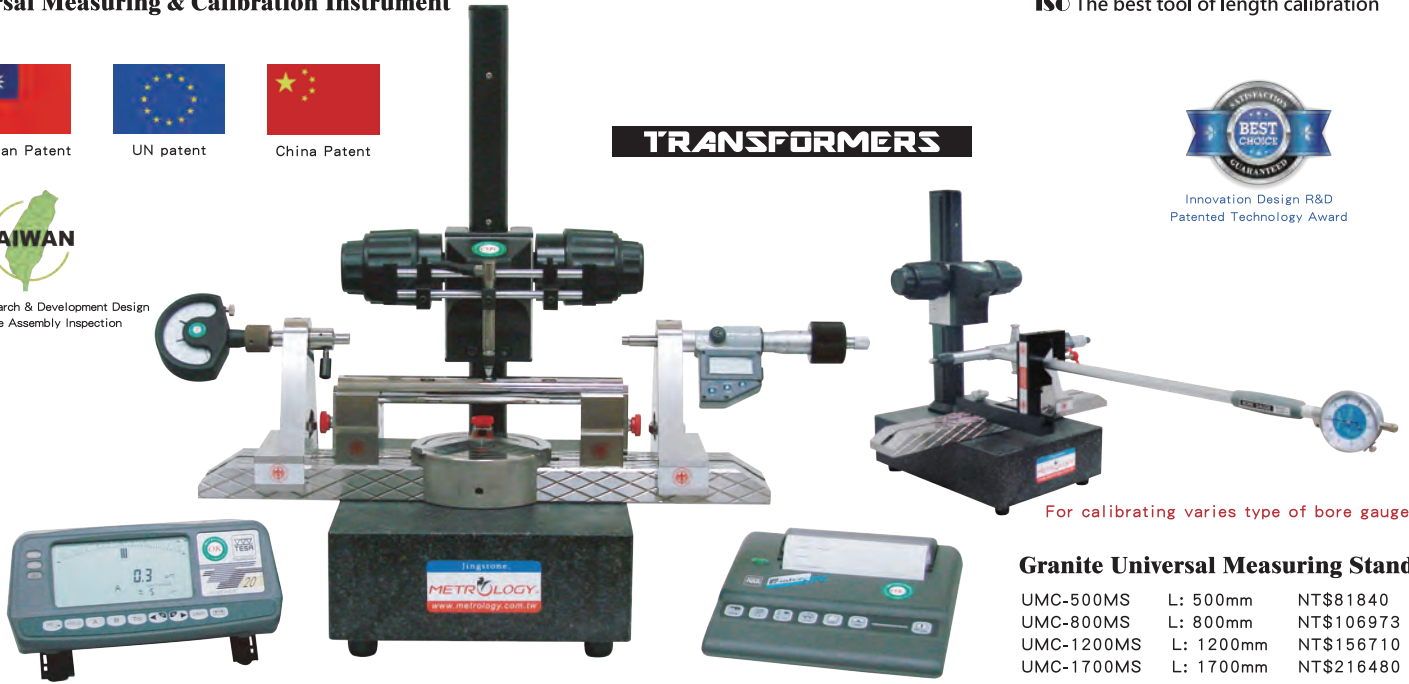

For calibrating varies type of bore gauges

**Granite Universal Measuring Stand**

UMC-500MS	L: 500mm	NT\$81840
UMC-800MS	L: 800mm	NT\$106973
UMC-1200MS	L: 1200mm	NT\$156710
UMC-1700MS	L: 1700mm	NT\$216480

**Diagram of measurement & calibration**

All accessories below are optional



Main body  
Universal measuring stand



Normal measuring function



Expandable  
measuring functions



Normal size universal  
measuring functions



Universal measuring functions  
for rapid comparative measuring

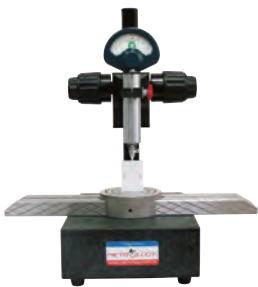

For Normal size direct and  
rapid comparative measuring



For measuring inside diameter  
& geometric tolerance



For measuring concentricity



For measuring geometric tolerance  
of normal cylindrical workpiece



Pair with concentric V blocks  
or concentric slide and  
measuring tips



For measuring geometric  
tolerance pair with concentric  
measuring stand



Observation & size  
measuring functions



Calibration function of  
caliper & micrometer



For calibrating varies  
type of dial indicators



For calibrating & measuring plug  
gauges, standard bars, and etc.

**Universal Length Measuring Instrument**

**ABBE Principle —**  
**Foundation of modern precision measurement**  
 The best tool of length measurement and calibration  
 Suitable for high-precision parts measurement and gauge calibration



Innovation Design R&D  
 Patented Technology Award



Innovation Research & Development Design  
 Manufacture Assembly Inspection

ULM-9000C Measuring length 0-700mm Resolution 0.0001mm/0.000001" NT\$

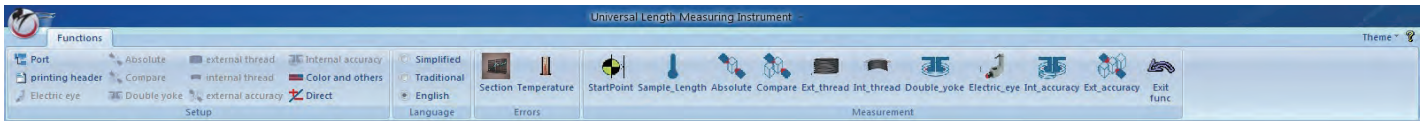

Standard gauge block absolute calibration

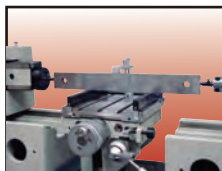

Long gauge block comparison calibration vertical & horizontal

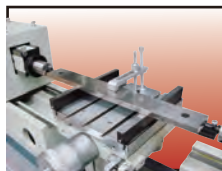

Universal yokes(optional)

Large size ring gauge calibration with magic eyes device



Small size ring gauge calibration with inner double yoke

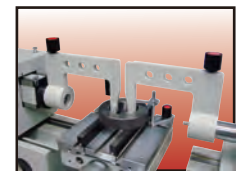

Medium size ring gauge calibration with inner double yokes



Standard bar calibration



Snap gauge holder(optional)

External snap gauge calibration

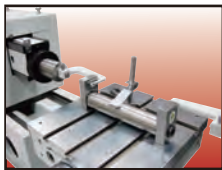

Internal setting gauge calibration

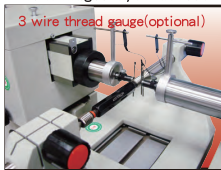

3 wire thread gauge(optional)

3 wire External thread gauge measurement with center carrier & V-type holder



3 wire thread gauge(optional)



Concentric bar External measurement with center carrier



Dial gauge calibration



Universal yokes(optional)

Digital dial gauge calibration



Universal yokes(optional)

Level-type indicator calibration

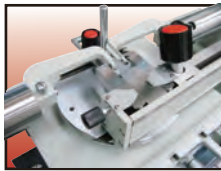

Universal yokes(optional)

Setting inner thread with set gauge

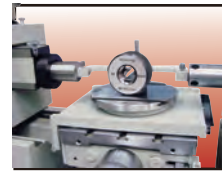

Inner thread gauge measurement with double yokes



Inner thread gauge measurement

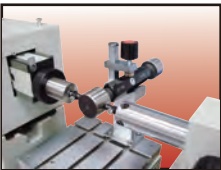

Plug gauge calibration with V-shaped carrier



Cylinder gauge calibration

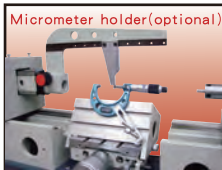

Micrometer holder(optional)

External micrometer calibration



Gauge block calibration with spherical measuring anvil



Small size ring gauge calibration with magic eye device

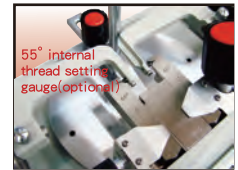

55° internal thread setting gauge(optional)

Setting zero for inner thread set gauge



ABBE measuring head

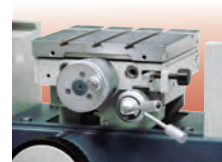

ABBE Worktable

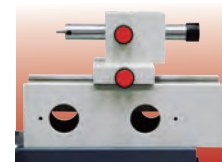

ABBE Tailstock

Optional accessories 3 wire thread gauge(for External thread measurement)





### Gauge Block Comparator

## NANOCAL Series

The best tool for ISO length calibration



Innovation Design R&D  
Patented Technology Award



Precision manufacture  
Assembly and inspection



Nanotechnology Precision Length Measurement System

Resolution 0.01 μm/0.000001"

GBC-P100T	0.1-100mm	NT\$
GBC-P300T	0.1-300mm	NT\$
GBC-P100H	0.1-100mm	NEW
GBC-P300H	0.1-300mm	NEW



Measuring table and position device



Center setting gauge



Gauge block tweezers sets

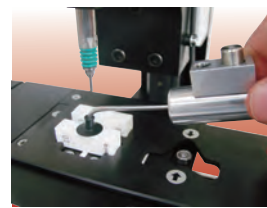

Suction for 30x9mm thin gauge block

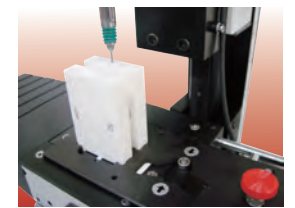

35x9mm Gauge block calibration

### Concentricity Test Bench



Innovation Design R&D  
Patented Technology Award

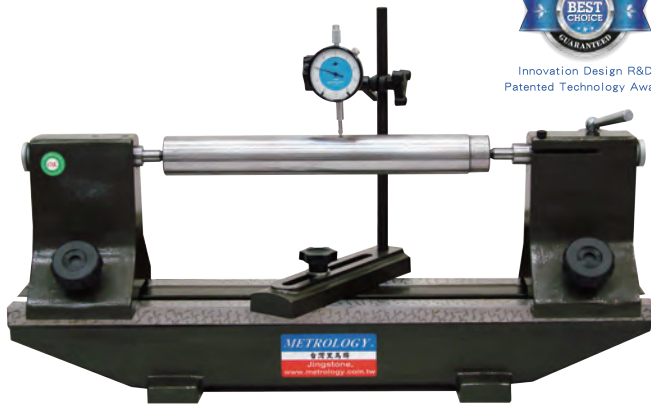

Fixed concentric slide



Precision grinding and scraping



Spring concentric slide

CTB-9200	480*70*80mm	Center Distance200mm	Height100mm	NT\$
CTB-9400	650*110*100mm	Center Distance400mm	Height140mm	NT\$
CTB-9600	900*110*100mm	Center Distance600mm	Height140mm	NT\$
CTB-9900	1250*120*150mm	Center Distance900mm	Height140mm	NT\$
CTB-91200	1400*200*180mm	Center Distance1200mm	Height170mm	NT\$

Custom specifications available as per client's request(indicator optional)

### Squareness Checkmaster



Innovation Design R&D  
Patented Technology Award



Taiwan patent



UN patent

### FREE-FALL SERIES



Compliance with ISO/IEC 17025 measurement traceability  
and accredited calibration laboratory (JCC) calibration report.

SCM-G300	300mm	NT\$
SCM-G600	600mm	NT\$
SCM-G900	900mm	NT\$



## HI-ACCURACY Digital Height Measuring Gauge



DHG-50 0-50mm/0-2" Resolution 0.5 μm Accuracy 1.5 μm NT\$  
 DHG-50H 0-50mm/0-2" Resolution 0.1 μm Accuracy 1.0 μm NT\$  
 DHG-100 0-100mm/0-4" Resolution 0.1 μm Accuracy 3.0 μm NT\$

Measuring bench with ceramic gauge surface

## Vertical Optical Projector



Innovation Design R&D  
Patented Technology Award



Projection screen size Φ300mm  
 Angle range 0°-360°  
 Projection screen resolution 0.001"

Optical scale resolution  
 0.001mm/0.00005"

VOP-48

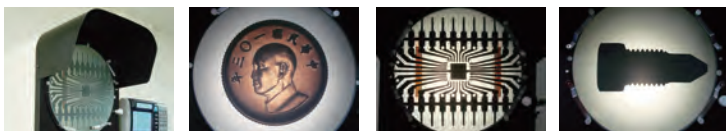

Fine ground glass screen

Surface projection

Profile&surface projection

Profile projection

VOP-26 150\*50mm NT\$  
 VOP-48 200\*100mm NT\$  
 VOP-612 300\*150mm NT\$

With 10X magnification lens and reflex lens, Built-in printer

## Micro Height Gauge

Electric measuring  
 aircushion floating  
**MICRO plus I&II**



Innovation Design R&D  
Patented Technology Award



Main Body structure design

1D(I)



Measuring system interface



Air bearing floating system



R&D assembly and inspection

2D(II)



MHG-E700I(1D)



MHG-E1000II(2D)

High resolution 0.0005mm/0.00002"

MHG-E450I	Measuring range 0-450mm	Expendable 765mm	NT\$
MHG-E700I	Measuring range 0-700mm	Expendable 915mm	NT\$
MHG-E1000I	Measuring range 0-1000mm	Expendable 1315mm	NT\$
MHG-E450II	Measuring range 0-450mm	Expendable 765mm	NT\$
MHG-E700II	Measuring range 0-700mm	Expendable 915mm	NT\$
MHG-E1000II	Measuring range 0-1000mm	Expendable 1315mm	NT\$

Super resolution 0.0001mm/0.000005" (Higher accuracy)

MHG-E450SII	Measuring range 0-450mm	Expendable 765mm	NT\$
MHG-E700SII	Measuring range 0-700mm	Expendable 915mm	NT\$
MHG-E1000SII	Measuring range 0-1000mm	Expendable 1315mm	NT\$

Application examples

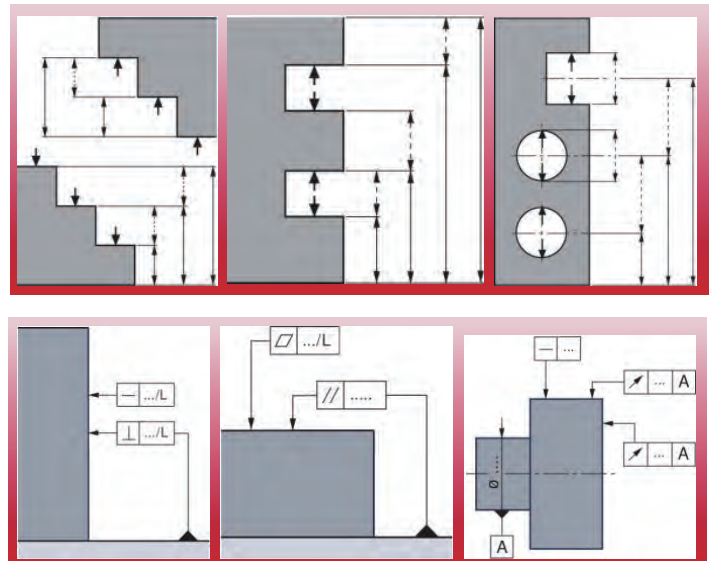



### Surface Roughness Tester (Fixed Type)

### Surface Roughness Tester (Separate Type)



SRT-9000C Resolution 0.001  $\mu\text{m}$  Measuring range 160  $\mu\text{m}$  NT\$



SRT-9000S Resolution 0.001  $\mu\text{m}$  Measuring range 320  $\mu\text{m}$  NT\$

### Measuring software interface

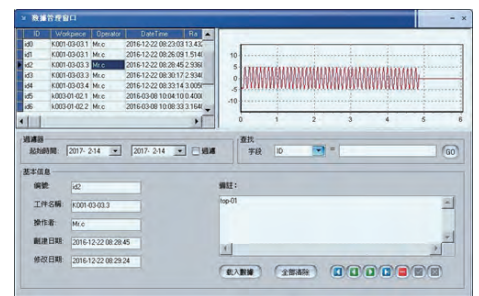
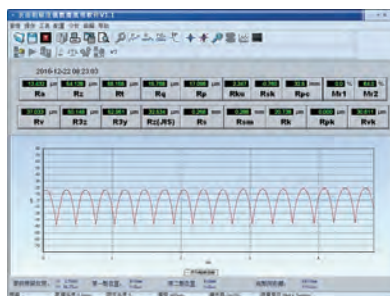
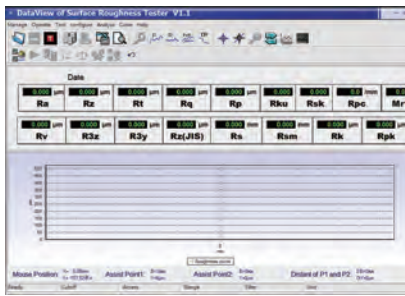

### Roundness Measuring Instrument

### Contour Measuring Instrument



RMI-D560C



Assembly & inspection of the whole machine



Measurement & Control System



Ultra-quiet stepper motor drive



Air bearing & float balancing device



DIN00 Granite body components



CMI-Z60R

RMI-D420 Max:  $\Phi 420\text{mm}$  NT\$  
RMI-D560C Max:  $\Phi 560\text{mm}$  NT\$

CMI-Z25 Z1-axis 25mm NT\$  
CMI-Z40 Z1-axis 40mm NT\$  
CMI-Z60 Z1-axis 60mm NT\$

Contour & Roughness Measuring Instrument (2 in 1 model)  
CMI-Z30R Z1-axis 30mm NT\$  
CMI-Z60R Z1-axis 60mm NT\$

RMI-D420



Roundness software interface

RMI-D560C

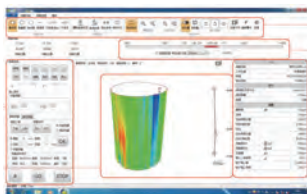

Cylindricity software interface

CMI-Z



Contour software interface

CMI-ZR



Roughness Measuring Software functions

## Image Measuring Instrument



Innovation Design R&D  
Patented Technology Award

### IMI-CNC Series (CNC-Automatic)

IMI-CNC600	600*500*200mm	NT\$
IMI-CNC800	800*600*200mm	NT\$
IMI-CNC1000	800*1000*200mm	NT\$
IMI-CNC1200	1000*1200*200mm	NT\$
IMI-CNC1500	1000*1500*200mm	NT\$
IMI-CNC2000	1500*2000*200mm	NT\$

### IMI-CNC-P Series (CNC+Probe)

IMI-CNC600P	600*500*200mm	NT\$
IMI-CNC800P	800*600*200mm	NT\$
IMI-CNC1000P	800*1000*200mm	NT\$
IMI-CNC1200P	1000*1200*200mm	NT\$
IMI-CNC1500P	1000*1500*200mm	NT\$
IMI-CNC2000P	1500*2000*200mm	NT\$

Z axis height can be customized according to requirements

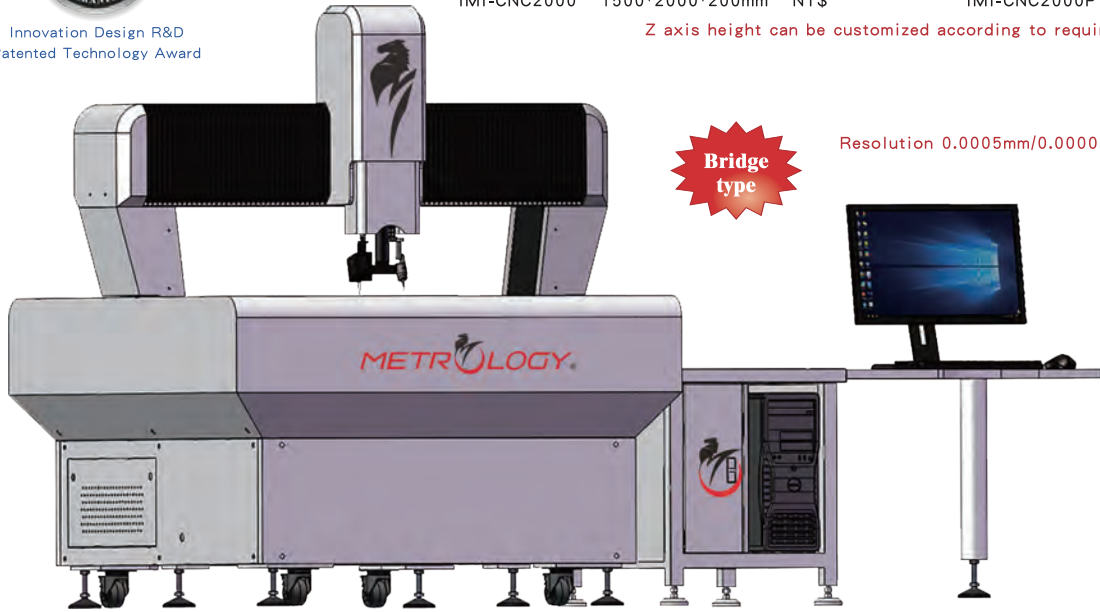

**Bridge type**

Resolution 0.0005mm/0.00002"



3D touch probe



3-axis joystick controller

## Image Measuring Instrument

- Design, R&D assembly, calibration
- Non-threaded screw
- High resolution color CCD
- Optical lens and drive system
- All granite structure



### IMI-TOP Series



Innovation Design R&D  
Patented Technology Award

IMI-CNC200

**All granite structure**

Steel instrument table  
IMI-desk23 NT\$  
IMI-desk45 NT\$

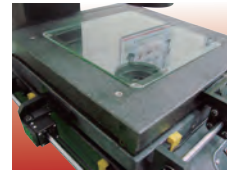

XY-axis granite table & base

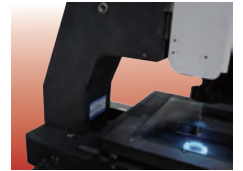

Arm-type granite Z-axis column



Precision linear roller guide

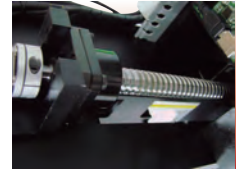

Precision ball screw drive



Smart control servo motor



High precision linear scale



Zoom magnification optical lens and 3D touch probe



Gigabit network million pixel color industrial camera

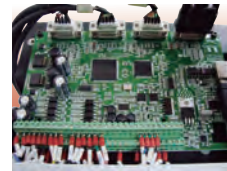

Integrated motion control card

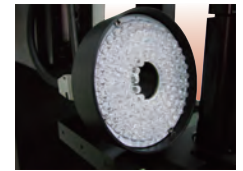

Programmable surface light source with four rings and eight sections



### Image Measuring Instrument



**2D manual Economic**

IMI-T100 100\*100mm NT\$  
Granite body base, 360° rotating table  
Resolution 0.001mm/0.00005"



**2D manual Economic**

IMI-T200 200\*100mm NT\$  
Metal body base  
Resolution 0.001mm/0.00005"



**2.5D manual Practical**

XYZ-axis DIN 00 grade granite measuring table

Resolution 0.001mm/0.00005"

IMI-P200 200\*100\*150mm NT\$  
IMI-P300 300\*200\*150mm NT\$  
IMI-P400 400\*300\*200mm NT\$  
IMI-P500 500\*400\*200mm NT\$

Z axis height can be customized according to requirements

### Image Measuring Instrument



Resolution 0.001mm/0.00005"

All granite structure



3D touch probe



Z-axis Controller



Innovation Design R&D Patented Technology Award

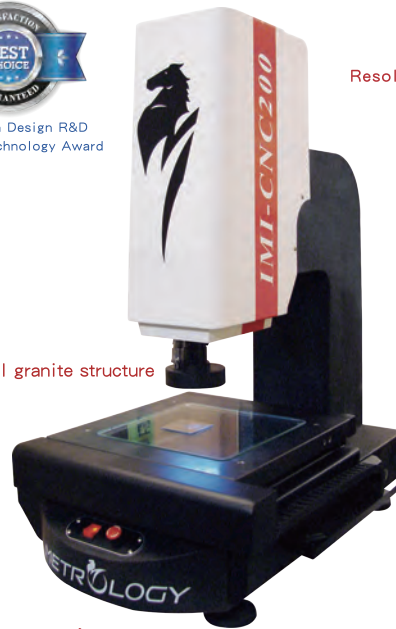

Resolution 0.0005mm/0.00002"

All granite structure



3D touch probe



3-axis joystick controller

**2.5D Autofocus**

IMI-AF200 200\*100\*150mm NT\$  
IMI-AF300 300\*200\*150mm NT\$  
IMI-AF400 400\*300\*200mm NT\$  
IMI-AF500 500\*400\*200mm NT\$

**2.5D CNC-Automatic**

IMI-CNC200 200\*200\*150mm NT\$  
IMI-CNC300 300\*200\*150mm NT\$  
IMI-CNC400 400\*300\*200mm NT\$  
IMI-CNC500 500\*400\*200mm NT\$

**2.5D/3D Autofocus + Probe**

IMI-AF200P 200\*100\*150mm NT\$  
IMI-AF300P 300\*200\*150mm NT\$  
IMI-AF400P 400\*300\*200mm NT\$  
IMI-AF500P 500\*400\*200mm NT\$

**2.5D/3D CNC-Automatic + Probe**

IMI-CNC200P 200\*200\*150mm NT\$  
IMI-CNC300P 300\*200\*150mm NT\$  
IMI-CNC400P 400\*300\*200mm NT\$  
IMI-CNC500P 500\*400\*200mm NT\$

Z axis height can be customized according to requirements

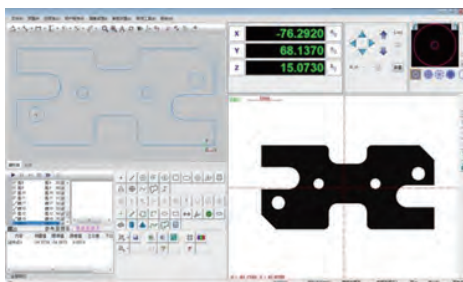

2.5D/3D Measurement software interface



Powerful geometric measurement function



Can export DXF and IGES format graphics data, graphics can be directly used in CAD reverse engineering.



Export EXCEL report



EXCEL export settings



Export WORD report

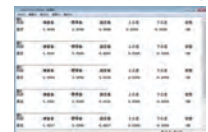

Export TXT report

## Second Measuring Imager

SMI series second measuring imager can be used in precision industries, such as molds, jigs, tools, screws, gears, automobiles, clocks, machinery, aerospace, electronics, semiconductors, rubber and plastics, automatic lathes, precision springs, precision stamping parts, terminals, connectors, mobile phones, printed circuit boards, medical equipment, cutting tools and other products and components



Vertical Optical Projector

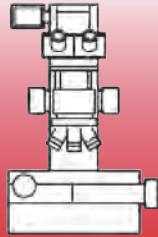

Tool microscope

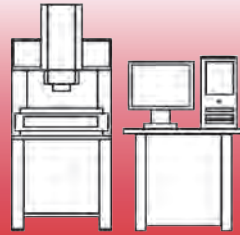
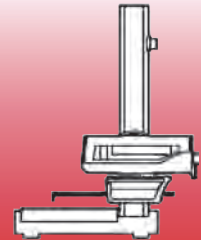

Image Measuring Instrument/CMM



Caliper/Micrometer



Contour Measuring Instrument



0.01  $\mu\text{m}$   
Resolution



within 1 second  
One-button automatic  
measurement  
100 sizes



1 time  
Measured in full  
field of view  
20000 sizes



10nm resolution  
50mm measuring range  
Maximum error 3.5  $\mu\text{m}$

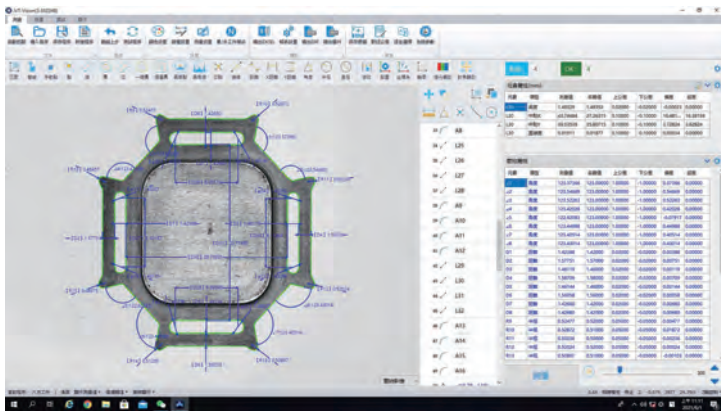

SMI-A82V Z-axis 45mm Measuring range 82\*55mm NT\$



SMI-AV Series



SMI-A120V Z-axis 45mm Measuring range 120\*80mm NT\$

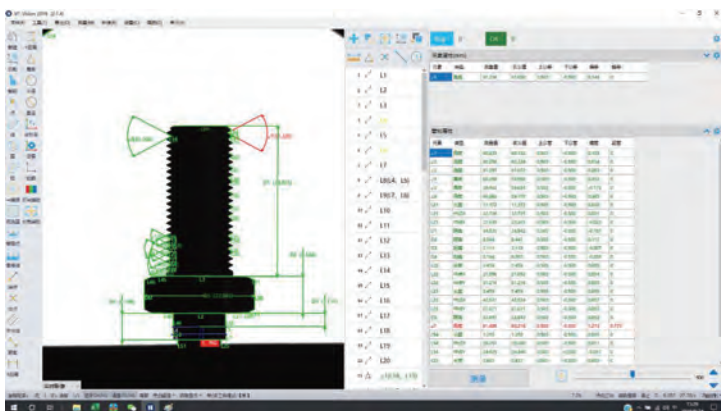

SMI-A82H Z-axis 50mm Measuring range 82\* $\Phi$ 55mm NT\$

SMI-AH Series

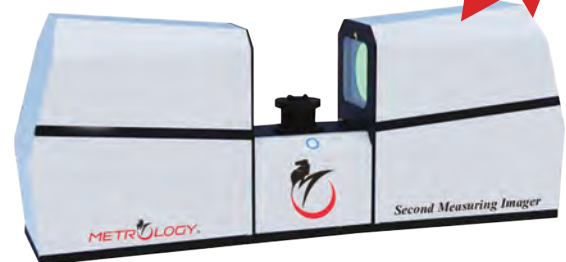

SMI-A120H Z-axis 40mm Measuring range 120\* $\Phi$ 80mm NT\$



### Coordinate Measuring Machine (Manual)



Innovation Design R&D  
Patented Technology Award



German craftsmanship Heritage International technique combination



Resolution 0.0005mm/0.00002"

CMM-564M-MCP	500*600*400mm	NT\$
CMM-785M-MCP	700*800*500mm	NT\$
CMM-7105M-MCP	700*1000*500mm	NT\$
CMM-7155M-MCP	700*1500*500mm	NT\$

MCP: Electronic manual trigger probe



Resolution 0.0005mm/0.00002"

CMM-564M-MH20i	500*600*400mm	NT\$
CMM-785M-MH20i	700*800*500mm	NT\$
CMM-7105M-MH20i	700*1000*500mm	NT\$
CMM-7155M-MH20i	700*1500*500mm	NT\$

MH20i: 15° indexing electronic manual trigger probe head+TP20

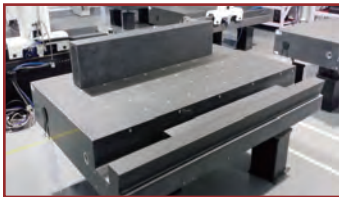

3-axis DIN00 grade granite

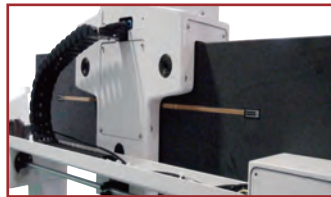

Fully enclosed frame bridge type mobile structure



XYZ axis reflection type metal grating measurement system



Renishaw High Precision Measuring System



Self-cleaning air bearing



Air pressure control tube and filter system

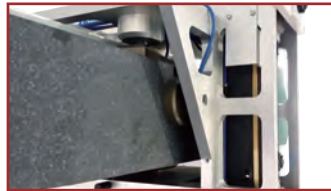

Z-axis cylinder equilibrator



XYZ axis non-screw drive bar device for fine position adjustment

### Coordinate Measuring Machine Visual DMIS measurement software



DMIS program input, output, editing and various report output

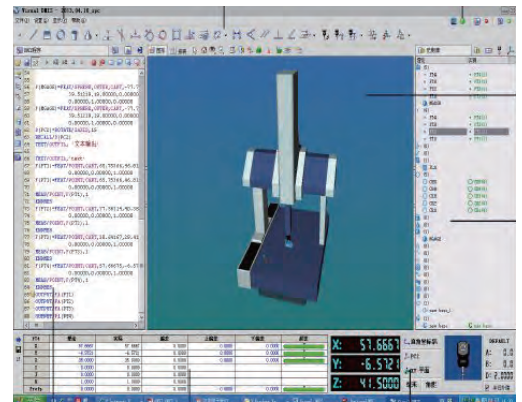
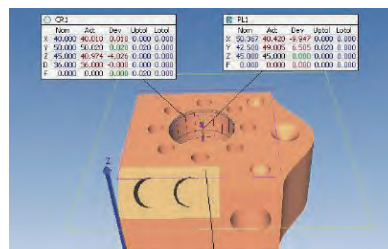

DMIS 3D Measurement software interface

Coordinate Measuring Machine (CNC)

**CNC Automatic**



*VelociRaptor*

**CNC Automatic**



*EmperorRaptor*



Innovation Design R&D  
Patented Technology Award

Resolution 0.0001mm/0.00001"

CMM-V564CNC-RTP20	500*600*400mm	NT\$
CMM-V686CNC-RTP20	600*800*600mm	NT\$
CMM-V8106CNC-RTP20	800*1000*600mm	NT\$
CMM-V8126CNC-RTP20	800*1200*600mm	NT\$

Optional: Probing systems

Resolution 0.0001mm/0.00001"

CMM-E8127CNC-RTP20	800*1200*700mm	NT\$
CMM-E10128CNC-RTP20i	1000*1200*800mm	NT\$
CMM-E10158CNC-RTP20	1000*1500*800mm	NT\$
CMM-E10228CNC-RTP20	1000*2200*800mm	NT\$
CMM-E121510CNC-RTP20	1200*1500*1000mm	NT\$
CMM-E122210CNC-RTP20	1200*2200*1000mm	NT\$

Optional: Probing systems

**CNC Automatic**



*T-Rex*

**CNC Automatic**



Innovation Design R&D  
Patented Technology Award

*BrontoSaurus*



Resolution 0.0001mm/0.00001"

CMM-T152012CNC-RTP20	1500*2000*1200mm	NT\$
CMM-T152512CNC-RTP20	1500*2500*1200mm	NT\$
CMM-T153012CNC-RTP20	1500*3000*1200mm	NT\$

Optional: Probing systems

Resolution 0.0001mm/0.00001"

CMM-B20Y15CNC	CMM-B30Y15CNC	CMM-B30Y20CNC
X:2000mm Z:1500mm	X:3000mm Z:1500mm	X:3000mm Z:2000mm

Y axis available measuring range 3000-10000mm



## RENISHAW

### probing systems for coordinate measuring machines

**MCP** Fixed probe head



M3 thread styli  
**Overtravel Protection**  
 Z-axis 5mm XY-axis  $\pm 20^\circ$   
 NT\$

**MH20i** Manual 15° indexing probe head



M2 thread styli  
**Overtravel Protection**  
 Magnetic TP20 Module  
 Allow Overtravel Collision Protection  
 Effective length up to 125mm  
 AB Axial 15° Incremental Indexing  
 NT\$ (with TP20)

**RTP20** Automated 15° indexing probe head



M2 thread styli  
**Overtravel Protection**  
 Magnetic TP20 Module  
 Allow Overtravel Collision Protection  
 Effective length up to 168mm  
 AB Axial 15° Incremental Indexing  
 NT\$ (with TP20)

**PH10** Motorised 7.5° indexing probe head



PH10T NT\$ (probe head only)  
 PH10M NT\$ (probe head only)

**PH10T**  
 Auto touch indexing probe head  
**PH10M&PH10MQ**  
 Auto touch & scanning indexing probe head

M2 thread styli  
**Allow Overtravel Collision Protection**  
 Magnetic TP20 or TP200 Module(optional)  
 Effective length up to 300mm  
 AB Axial 7.5° Incremental auto Indexing

**PH20** 5-axis touch trigger system



**PH20** NT\$ (Sets)  
 5-axis limitless angles and positions  
**PH20MT** NT\$ (Sets)  
 3-axis limitless angles and positions

M2 thread styli  
**Allow Overtravel Collision Protection**  
 Magnetic TP20 Module  
 Effective length up to 166mm  
 AB Axial limitless angles and positions auto Indexing

**REVO** 5-axis multi-sensor scanning system



**REVO 5**  
 Increased measuring speed, up to 500 mm/sec  
 Maximum reach up to 500 mm with maintained effective working length

Data collection rates up to 6,000 points per second  
 AB Axial limitless angles and positions auto Indexing

## RENISHAW Styli and accessories

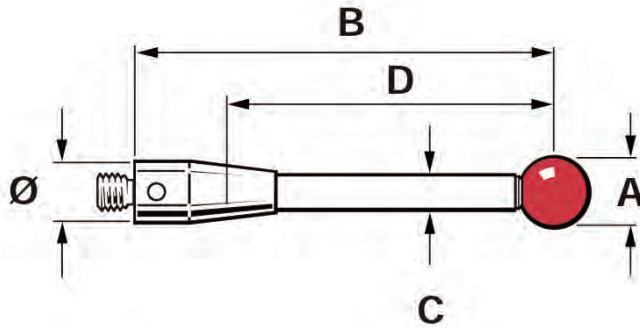

- A Ball diameter
- B Overall length
- C Stem diameter
- D Effective working length
- Ø M2=3mm
- Ø M3=4mm
- Ø M4=7mm
- Ø M5=10mm

Ruby ball styli: stainless steel stems/tungsten carbide stems/ceramic stems/carbon fibre stems/extensions rod

Star styli (Fixed)

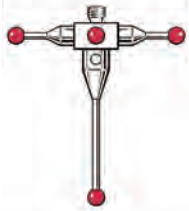

Star styli centres



Disc styli



Cylinder styli



Cylinder styli



Parallel hemispherical ended styli



Special purpose styli



## RATIONAL DMIS CAD+ MEASURING SOFTWARE

CMM-Rational DMIS NT\$

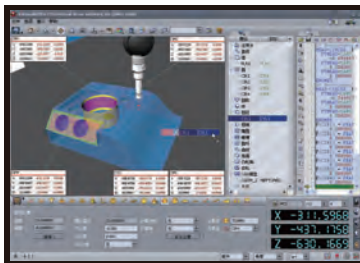

Drag & drop operation  
Simple and fast operation

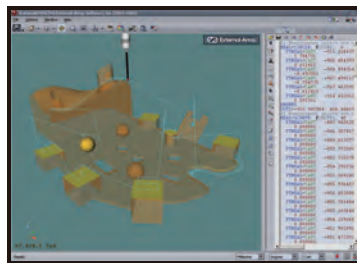

Smart detection  
Automatically identify elements

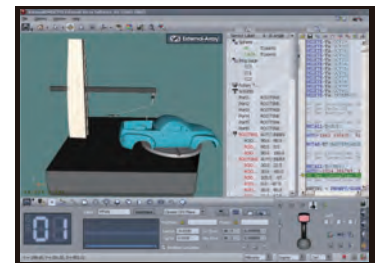

Graphical display  
Instant simulation preview

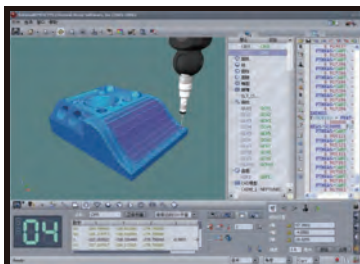

Simple, intuitive and  
easy-to-operate interface



Reliability, accuracy, world  
authoritative PTB recognition

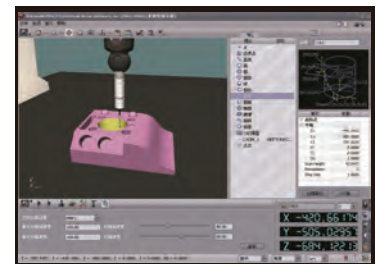

Powerful CAD function,  
support file import and export



**Hardness Testing Equipment**

*ASTM E18-15 Rockwell, ASTM E10-15 Brinell, ASTM E384 Vickers Test standards  
The metal material hardness test method of this product is in full compliance  
with the American Society for Testing and Materials*



Assembly & Inspection



Sophisticated Sensors  
Microcomputer Control System



Digital Display Encoder  
Data Computing System



Test Structure Design



Precision Cast Iron Body



**Manual**

Minimum measuring unit 0.5HR

Rockwell Hardness Tester  
RHT-9000M NT\$54648



**Electric**

Rockwell Hardness Tester  
RHT-9000E NT\$68640



**Digital**



Innovation Design R&D  
Patented Technology Award

Digital Rockwell hardness tester  
RHT-9000D NT\$154915  
Digital Superficial Rockwell hardness tester  
RHT-S9000D NT\$183955

General Rockwell hardness tester test hardness value range HRA20-88 HRB20-100 HRC20-70

**Hardness Testing Equipment**



**Electric**

Brinell Rockwell Vickers Hardness Tester(Electric)  
BRV-9000E Graduation 0.5HR NT\$188496  
Brinell Rockwell Vickers Hardness Tester(Digital)  
BRV-9000D Graduation 0.1HR NT\$410784  
Hardness value range  
20-88HRA 20-100HRB 20-70HRC 8-650HB 8-3000HV



**Electric**

Brinell Hardness Tester(Electronic)  
BHT-3000E Resolution 0.005mm NT\$158717  
Hardness value range 8-650HBW



**Digital**

Brinell Hardness Tester(Digital)  
BHT-3000D Resolution 0.00125mm NT\$387235  
Hardness value range 8-650HBW



Innovation Design R&D  
Patented Technology Award

Brinell hardness measurement software HB-CCD-B NT\$89760(without PC)

**Hardness testing equipment**



Innovation Design R&D  
Patented Technology Award



American Society of Testing and Materials



Minimum measuring unit  
0.02 μm  
Hardness value range  
8-3000HV



Minimum measuring unit  
0.01 μm  
Hardness value range  
1-4000HV



- Vickers Hardness Tester**  
 VHT-A9010 Max. test force 10KG NT\$216374  
 VHT-A9050 Max. test force 50KG NT\$216374  
**Vickers Hardness Tester(Digital)**  
 VHT-A9010D Max. test force 10KG NT\$320879  
 VHT-A9050D Max. test force 50KG NT\$320879

- Micro-Vickers Hardness Tester**  
 MHT-A1000 Max. test force 1KG NT\$216374

- Micro-Vickers Hardness Tester(Digital)**  
 MHT-A1000D Max. test force 1KG NT\$291139

Vickers Hardness Measuring Software HV-CCD-B NT\$59030(without PC)

**Hardness testing equipment**

**Leeb Hardness Tester**

**Webster Hardness Tester**



**Testing Range**  
 HL(170-960) \ HRA(59.1-88) \  
 HRB(13.5-101.7) \ HRC(17.9-69.5) \  
 HB(19-683) \ HS(30.6-102.6) \  
 HV(80-1042)

- LHT-9000DL(special type) NT\$58740  
 Leeb hardness block HLD-SB NT\$3300  
 LHT-9000D(standard type) NT\$19800

Material testing: Mainly used to test the hardness of aluminum, copper and steel materials, which can be converted into other hardness values such as: HV \ HB \ HRB \ HRE \ HRF \ HRH \ HBa  
 WHT-W20 Testing Range 0-20HW NT\$22704(set)



**Barcol Hardness Tester**



Material testing:  
Particularly suitable for testing pure aluminum, low hardness aluminum alloys, and extra-large & thick materials

- BHT-B934 Testing Range 0-100HBa NT\$37950(set)



Innovation Design R&D  
Patented Technology Award



**Leeb hardness tester (Separate)**



**Testing Range**  
 HL(170-960) \ HRA(59.1-88) \  
 HRB(13.5-101.7) \ HRC(17.9-69.5) \  
 HB(19-683) \ HS(30.6-102.6) \  
 HV(80-1042)

- LHT-9000S NT\$25080(set)

- LHT-9000SP(built-in printer) NT\$30360(set)



Test diagram



### Coating Thickness Gauge (Fixed probe)



American Society of Testing and Materials



Taiwan Excellent Products Diamond Gold Award



Minimum resolution 0.1  $\mu\text{m}$   
Measuring range 0-1250  $\mu\text{m}$



**Electromagnetic type Coating thickness gauge**  
CTG-9000F NT\$15840  
Measurement object:  
non-magnetic coating on magnetic metal

**Eddy current type Coating thickness gauge**  
CTG-9000N NT\$15840  
Measurement object:  
non-conductive insulating coating on non-magnetic metal

**Dual-purpose Coating thickness gauge**  
CTG-9000FN NT\$25080  
Can measure the thickness of non-magnetic plating and coating on magnetic metal substrates and measure non-conductive plating and coating on non-magnetic metal substrates. Layer thickness

### Dual purpose Coating Thickness Gauge (Interchangeable probe)



Minimum resolution 0.1  $\mu\text{m}$   
Measuring range 0-1250  $\mu\text{m}$



Dual purpose Coating Thickness Gauge (Test main machine) CTG-9000P NT\$25080 F magnetic or N non-magnetic probe (Optional)

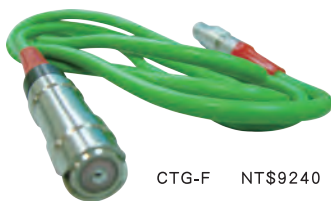

Electromagnetic probe (F type magnetic) CTG-F NT\$9240

Measurement object non-magnetic coating on magnetic metal

#### Optional Probe

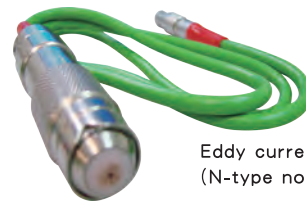

CTG-N NT\$9240 Eddy current probe (N-type non-magnetic)

Measurement object non-conductive insulating coating on non-magnetic metal

### Ultrasound Thickness Gauge

Capable of performing measurements on a wide range of material, including metals, plastic, ceramics, composites, epoxies, glass and other ultrasonic wave well-conductive materials.



American Society of Testing and Materials



Taiwan Excellent Products Diamond Gold Award

Minimum resolution 0.01mm  
Measuring range 0-600mm

UTG-9000 NT\$14256 1.Shell 2.Keyboard 3.Monitor 4.Transmit & receive socket 5.Thickness calibration block 6.Ultrasonic probe



# ISO IEC 17025 International Accreditation

Length calibration, Dimension measurement, Hardness test



International Laboratory Accreditation Cooperation  
- Mutual Recognition Arrangement

Taiwan Accreditation Foundation



**JCC**  
Jingstone  
Precision Instrument Calibration Center  
Length Calibration Laboratory



## JCC Accredited Item

1. Measuring gauge: Gauge block, Long gauge block, Plug & Ring gauge, Thread plug & Ring gauge, 3-Wire thread gauge
  2. Dial indicator: Dial & Digital indicator, Level-type dial indicator
  3. Caliper: Vernier, Dial, Digital caliper (Inside & Outside diameter)
  4. Micrometer: Vernier & Digital outside & inside micrometer
- \*Above can provide the calibration report of TAF and ILAC MRA certification marks

Major equipment of calibration: Universal length measuring instrument, Gauge block comparator, Hi-accuracy dial indicator calibrator, Multifunctional length calibrator, Checkmaster gauge, High-precision Gauge block & Ring gauge sets

## JCC Calibrated Traceability

JCC provides the measuring traceability calibrated report to meet the ISO measurement traceable validity



**MMT**  
Metrology  
Precision Measuring & Testing Laboratory



## MMT Accredited Item

1. Measurement of dimensional and geometric tolerances of metal and alloy materials and products, molds, parts, components, inspection tools, and jigs
2. Measurement of dimensional and geometric tolerances of cement, clay, ceramics and related materials, glass products, molds, parts, components, inspection tools and fixtures

\*Above can provide the calibration report of TAF and ILAC MRA certification marks

Main measurement equipment: Hi-accuracy Coordinate Measuring Machine  
Main testing equipment: Rockwell/Superficial/Brinell/Knoop/Vickers/  
Micro-Vickers Hardness Tester

## MMT Measuring & Testing Traceability

MMT provides the measuring traceability Measuring & Testing report to meet the ISO measurement traceable validity



# Jingstone Precision Group Professional technical service project

## Technology Centers & Showrooms



## Product Support

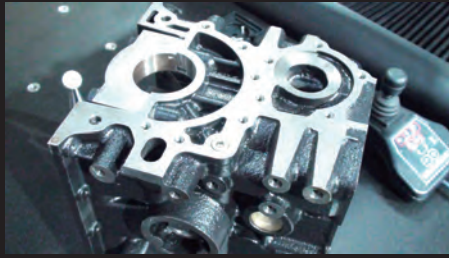

## Repair Service



## Field Service



## Software Training

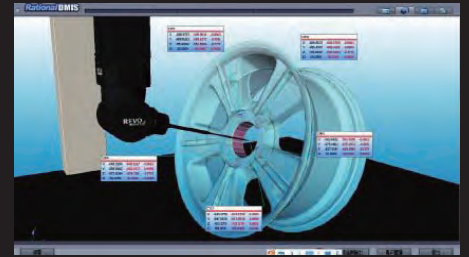

## Technical Seminar







Taiwan Excellent Products  
Diamond Gold Award

# JINGSTONE PRECISION GROUP

SINCE 1983 IN TAIWAN

## INSTRUMENT & CALIBRATOR



Innovation Design R&D  
Patented Technology Award



German  
Innovation patent



US  
Invention patent

### PATENT CERTIFICATE



EU  
International Patent



Taiwan  
Invention patent



China  
Utility patents

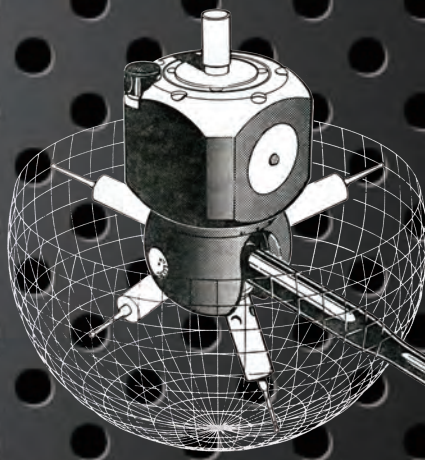

Renishaw Probe & Styli



Gauge Block Comparator

Squareness Checkmaster

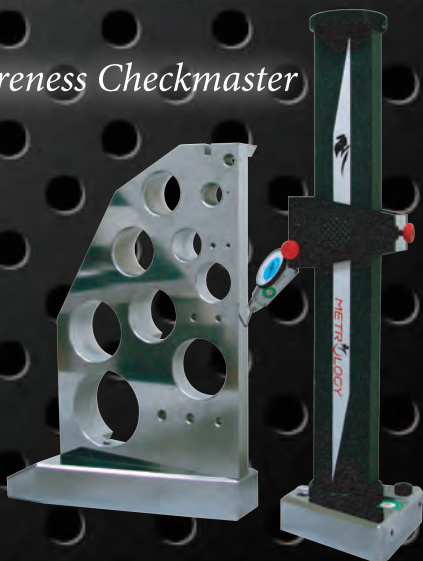

Global Distributor



Universal Length Measuring Instrument

