

Teknik Makina 1987 yılında otomotiv sektöründe imalat hayatına başlamıştır. Bir süre bu sektörde hizmet verdikten sonra 1994'te sektör değiştirerek, kesici takımlar imalatına adım atmıştır. Yaklaşık 5000'i aşkın ürün çeşidi ile geniş bir üretime sahiptir. Kurulduğundan bu güne kadar performans, kalite ve maliyet olarak en iyi ürünlerle hizmet vermeye devam etmektedir. Kuruluşundan bu yana yüksek teknolojiye, yeniliklere, yeni projelere açık olup kendisini sürekli yenilemektedir.

Ürünlerinin ve hizmetinin kalitesini artırarak ISO9001:2015 belgesini almış; müşteril-

erinin var olan güvenini daha da pekiştirmiştir. Kısa ve uzun vadeli oluşturulmuş kalkınma plânlarıyla yıllık üretim adetlerini yükseltmeyi hedeflemiştir.

TEKNİK MAKİNA konusunda uzman çalışanları ile ilk günkü heyecan ve istekle çalışmalarını sürdürerek Dünya ve Türkiye pazarındaki yerini daha da sağlamlaştırarak yükselen grafiğini aynı istikrarda yürütmeye ve ülke ekonomisine katkılarını sürdürmekte kararlıdır.



Technical solution for quality

Kalite için TEKNİK Çözüm

Teknik Cutting tools has been established in 1987 in Turkey. Teknik Cutting Tools started to produce cutting tools in 1994. Over 5.000 kinds of tools are produced in the factory building located in the Fourth Industrial Area of Konya since 2015. Teknik Cutting Tools is a very experienced producer for a large range of a Cutting Tools: Face Mills, End Mills, Boring Bars, External Turning Holders and more. There are 40 production lines which are capable to produce in several categories at the same time.











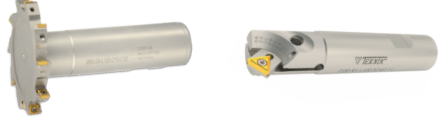

We keep up to date with new products and when customers need special tools we do all we can to produce the tools to meet their expectations.







Production and designing teams are all educated and certified according to the ISO 9001:2015 quality standard to serve you better.

The Company Headquarters is also located in Konya.

Konya and Istanbul branches are dedicated with marketing and sales. Teknik Cutting Tools does international trade as cutting tools exporter with many countries all around the World and offers the highest level of quality, service and reliability, in a very short lead-time with the best price, guaranteed.

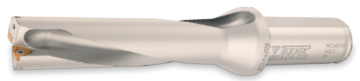

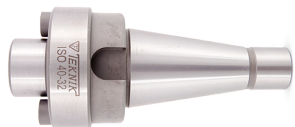
İçindekiler Index	P./S.	Ürün Türü Product Type	
	6-50	Tarama Başlığı	
		Face Mill	
		Eckmesserkopf-Rundplattenfräser	
	52-62	Baralar	
		Borings	
		Ausdrehwerkzeug	
	64-66	Helis Freze - Disk Freze	
		Shoulder Milling - Disc Milling	
		Igelfräser - Scheibenfräser	
	68-73	T-Kanal Freze	
		T-Slot Milling Cutter	
		T-Nutenfräser	
	76-104	Saplı Tarama - Küre Uçlu Freze	
		End Mill - Radius Cutter - Schaftfräser	
		Küre Uçlu Freze - Radius Cutter - Kugelfräser	
	106-112	Vidalı Takım	
		Modular End Mill	
		Einschraubfräser	
	116-122	Diş Katerleri	
Threading Holder			
Klemmhalter (Außengewinde)			
124-132	P Sistem Kater Sogutmalı		
	P System Turning Holder With Coolant		
	P System Drehhalter		
134-138	P Sistem Kater		
	P System Turning Holder		
	P System Drehhalter		
142-153	D Diş Çap Kater		
	D External Turning Holders		
	D System Klemmhalter		
156-170	S Sistem Diş Çap Kater		
	S System External Turning Holders		
	S System ystem Klemmhalter		
172-179	P Sistem İç Çap Kater		
	P System Boring Bars		
	P System Bohrstange		
182-191	D Sistem İç Çap Kater		
	D System Boring Bars		
	D System Bohrstange		

P./S.	Ürün Türü Product Type	
194-210	S Sistem İç Çap Kater	
	S System Boring Bars	
	S System Bohrstange	
212-216	Karbür Takımlar ve Setler	
	Carbide Tools / Set	
	VHM Bohrstange / Set	
218-219	İç Çap Kater Set	
	Boring Bars Set	
	Bohrstangen Set	
222-234	U-Drill	
	Indexable Insert Drills	
	Vollbohrer	
236-247	Kanal Kater - Keski Kütüğü	
	Grooving Holders - Block For Blades	
	Stech-Klemmhalter - Grundhalter für Absteichschwer	
250-254	İç Çap Kanal Kater	
	Grooving Holders Mini Tool	
	Stech-Klemmhalter	
256	Takım Tutucuları	
	Tool Holders	
	Werkzeugaufnahmen	
258-261	Yedek Parça	
	Spare Parts	
	Zubehör	
262-269	Kesme Verileri - ISO Kodları	
	Cutting Data- ISO Code	
	Schnittdaten - ISO Code	

Kalite için Teknik Çözüm

Technical solution for quality



Tarama Başlıkları
Face Milling Tools
Eckmesserkopf
Planmesserkopf
Rundplattenfräser

Havşa Freze
Chamfer End Mills
Fasenfräser



**Technical Solution
for Quality**



45° SNKX 1206

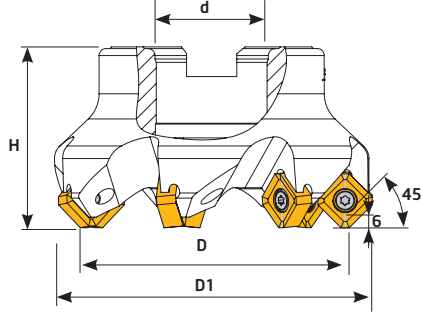

Ölçüler (mm) Dimensions(mm) Abmessungen (mm)				SNKX 1206	
L	s	a	d1		
12,7	6,35	2,36	4,5		

Sipariş Kodu Order Code Best.-Nr.	Stok/Stock/Lager	Ürün Kodu Product Code Produkt-Code	Ölçüler (mm) Dimensions(mm) Abmessungen (mm)						Kullanılan Uç Insert WSP	Sıkma Cıvatası Clamp Screw Torx-Schraube	Anahtar Torx Key Torx-Schlüssel
			D	D1	d	Z	H	kg			
T319	●	D040 d16 Z03 SNKX 12	40	53	16	3	45	0,417	SNKX 1206	TC076 M4x12,5	T15
T320	●	D050 d22 Z04 SNKX 12	50	63	22	4	44	0,593			
T322	●	D063 d22 Z06 SNKX 12	63	76	22	6	44	0,710			
T325	●	D080 d27 Z07 SNKX 12	80	93	27	7	52	1,334			
T330	●	D100 d32 Z08 SNKX 12	100	113	32	8	52	1,926			
T332	●	D125 d40 Z10 SNKX 12	125	138	40	10	63	3,780			
T334	●	D160 d40 Z12 SNKX 12	160	173	40	12	63	5,380			
T335	●	D200 d60 Z14 SNKX 12	200	213	60	14	63	6,690			

KRLY -PLBT-BHLR ucuna uygundur. / Compatible with KRLY -PLBT-BHLR insert. / Kompatible für KRLY -PLBT-BHLR WP

45° SNMU 1305

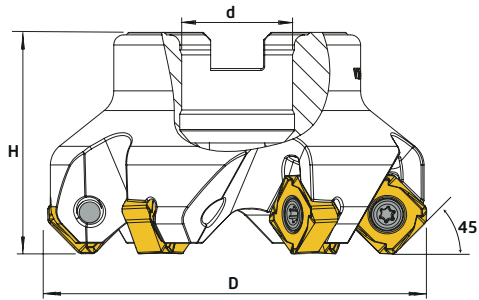

Ölçüler (mm) Dimensions(mm) Abmessungen (mm)		SNMU 1305	
l	s		
13	5,6		



Sipariş Kodu Order Code Best.-Nr.	Stok/Stock/Lager	Ürün Kodu Product Code Produkt-Code	Ölçüler (mm) Dimensions(mm) Abmessungen (mm)					Kullanılan Uç Insert /WSP	Sıkma Cıvatası Clamp Scr /Torx-Schraube	Anahtar Torx Key / Torx-Schlüssel
			D	d	Z	H	kg			
T234	●	D050 d22 Z04 SNMU 13	50	22	4	44	0,480	SNMU 1305 ISCR	TC083 M5x12	T20
T235	●	D063 d22 Z06 SNMU 13	63	22	6	44	0,645			
T236	●	D080 d27 Z07 SNMU 13	80	27	7	52	1,147			
T237	●	D100 d32 Z08 SNMU 13	100	32	8	52	1,487			
T238	●	D125 d40 Z10 SNMU 13	125	40	10	63	3,610			



ISCR ucuna uygundur. / Compatible with ISCR insert. / Kompatible für ISCR WP

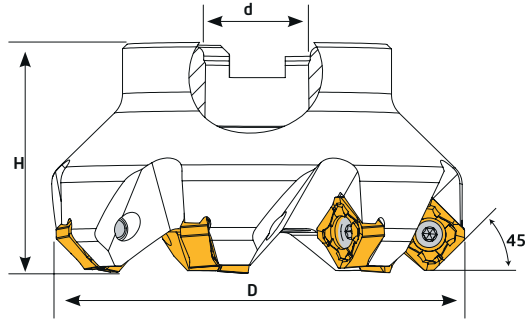

45° SNEU 1206



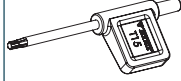

Ölçüler (mm) Dimensions(mm) Abmessungen (mm)				SNEU 1206	
L	s	a	d1		
12,7	6,35	2,2	6		



Sipariş Kodu Order Code Best.-Nr.	Stok/Stock/Lager	Ürün Kodu Product Code Produkt-Code	Ölçüler (mm) Dimensions(mm) Abmessungen (mm)					Kullanılan Uç Insert WSP	Sıkma Cıvatası Clamp Screw Torx-Schraube	Anahtar Torx Key Torx-Schlüssel
			D	d	Z	H				
T164	●	D050 d22 Z05 SNEU 12	50	22	5	40	0,447			
T165	●	D063 d22 Z06 SNEU 12	63	22	6	40	0,582			
T166	●	D080 d27 Z07 SNEU 12	80	27	7	50	1,252			
T167	●	D100 d32 Z08 SNEU 12	100	32	8	50	1,925			
T168	●	D125 d40 Z10 SNEU 12	125	40	10	63	3,516			

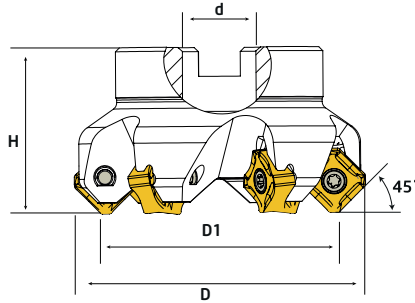

XTC-GSC-WLTR-LMN ucuna uygundur. / Compatible with XTC-GSC-WLTR-LMN insert. / Kompatible für XTC-GSC-WLTR-LMN WP

45° SNKX 1206-ONHX 0505



Ölçüler (mm) Dimensions(mm) Abmessungen (mm)				SNKX 1206	
L	S	a	d1		
12,7	6,35	2	9,3		

Ölçüler (mm) Dimensions(mm) Abmessungen (mm)			ONHX 0505	
L	d	s		
5,3	12,7	5,2		

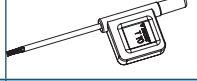
Sipariş Kodu Order Code Best.-Nr.	Stok/Stock/Lager	Ürün Kodu Product Code Produkt-Code	Ölçüler (mm) Dimensions(mm) Abmessungen (mm)					Kullanılan Uç Insert WSP	Sıkma Cıvatası Clamp Screw Torx-Schraube	Anahtar Torx Key Torx-Schlüssel	
			D	D1	d	Z	H				
T623	●	D050 d22 Z04 SNKX 12 ONHX 05	50	42,4	22	4	40	0,458			
T624	●	D063 d22 Z06 SNKX 12 ONHX 05	63	55,4	22	6	40	0,608			
T625	●	D080 d27 Z07 SNKX 12 ONHX 05	80	72,4	27	7	50	1,051			
T626	●	D100 d32 Z08 SNKX 12 ONHX 05	100	92,4	32	8	50	1,813			
T627	●	D125 d40 Z10 SNKX 12 ONHX 05	125	117,4	40	10	63	3,277			
T628	●	D160 d40 Z12 SNKX 12 ONHX 05	160	152,4	40	12	63	4,577			

PLBT ucuna uygundur. / Compatible with PLBT insert. / Kompatible für PLBT WP

● Stokta/ In Stock/ Lager ○ Sınırlı Stok/ Limited Stock/ Begrenzte Lagerhaltung

Kalite için Teknik Çözüm | Technical Solution For Quality

BROTECH

TEKNİK
Cutting Tools

www.teknikcuttingtools.com

7

45° SNKX 1606-ONHX 0606

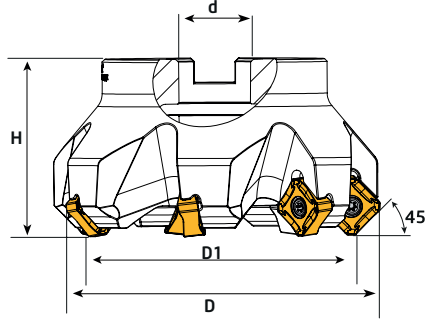
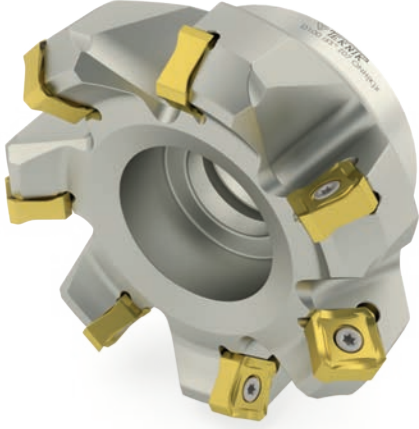

Ölçüler (mm) Dimensions(mm) Abmessungen (mm)				SNKX 1606	
L	S	a	d1		
16,5	7	2,5	11,7		

Ölçüler (mm) Dimensions(mm) Abmessungen (mm)			ONHX 0606	
L	S	a		
6,2	16,5	6,35		

Sipariş Kodu Order Code Best.-Nr.	Stok/Stock/Lager	Ürün Kodu Product Code Produkt-Code	Ölçüler (mm) Dimensions(mm) Abmessungen (mm)						Kullanılan Uç Insert WSP	Sıkma Cıvatası Clamp Screw Torx-Schraube	Anahtar Torx Key Torx-Schlüssel
			D	D1	d	Z	H				
T629	●	D063 d22 Z05 SNKX 16 ONHX 06	63	63	22	5	50	0,776			
T630	●	D080 d27 Z06 SNKX 16 ONHX 06	80	80	27	6	50	2,013			
T631	●	D100 d32 Z07 SNKX 16 ONHX 06	100	100	32	7	63	2,750			
T632	●	D125 d40 Z08 SNKX 16 ONHX 06	125	125	40	8	63	4,026			
T633	●	D160 d40 Z10 SNKX 16 ONHX 06	160	160	40	10	63	4,712			
T634	●	D200 d60 Z12 SNKX 16 ONHX 06	200	200	60	12	63	8,112			

PLBT ucuna uygundur. / Compatible with PLBT insert. / Kompatibel für PLBT WP

45° SDHT 1204

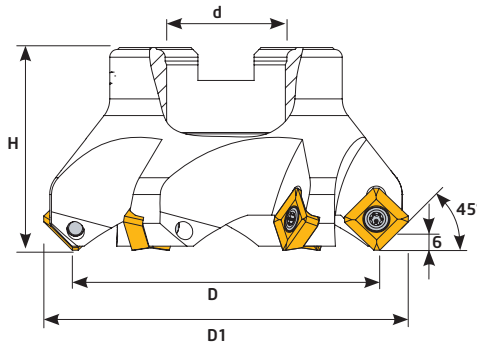

Ölçüler (mm) Dimensions(mm) Abmessungen (mm)		SDHT 1204	
L	S		
12,7	4,76		

Sipariş Kodu Order Code Best.-Nr.	Stok/Stock/Lager	Ürün Kodu Product Code Produkt-Code	Ölçüler (mm) Dimensions(mm) Abmessungen (mm)						Kullanılan Uç Insert WSP	Sıkma Cıvatası Clamp Screw Torx-Schraube	Anahtar Torx Key Torx-Schlüssel
			D	D1	d	Z	H				
T300	●	D063 d22 Z05 SDHT 12	63	77	22	5	45	0,630			
T302	●	D080 d27 Z06 SDHT 12	80	94	27	6	52	1,200			
T304	●	D100 d32 Z07 SDHT 12	100	114	32	7	62	2,040			
T305	●	D125 d40 Z08 SDHT 12	125	139	40	8	62	4,095			



45° SEET 12T3 R245

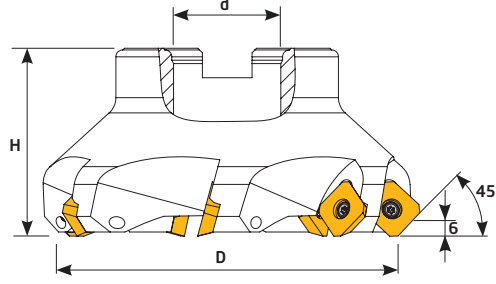
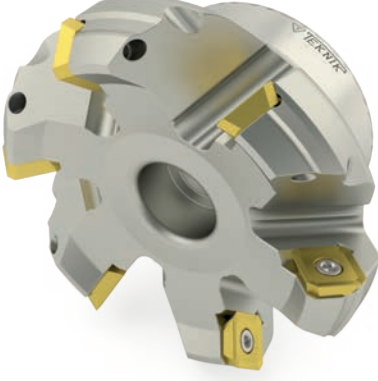

Ölçüler (mm) Dimensions(mm) Abmessungen (mm)		SEET 12T3 R245	
L	S		
13,4	3,97		

Sipariş Kodu Order Code Best.-Nr.	Stok/Stock/Lager	Ürün Kodu Product Code Produkt-Code	Ölçüler (mm) Dimensions(mm) Abmessungen (mm)					Kullanılan Uç Insert WSP	Sıkma Cıvatası Clamp Screw Torx-Schraube	Anahtar Torx Key Torx-Schlüssel
			D	d	Z	H	kg			
T435	●	D063 d22 Z05 SEET 12	63	22	5	50	0,815	SEET 12T3 R245	TC067 M3,5x8,5	T15
T436	●	D080 d27 Z06 SEET 12	80	27	6	52	1,305			
T437	●	D100 d32 Z07 SEET 12	100	32	7	55	1,715			
T438	●	D125 d40 Z08 SEET 12	125	40	8	62	3,427			

ZCC -SNDVK-XTC-ucuna uygundur. / Compatible with ZCC -SNDVK-XTC- insert. / Kompatible für ZCC -SNDVK-XTC- WP

45° SEET 12T3 R245

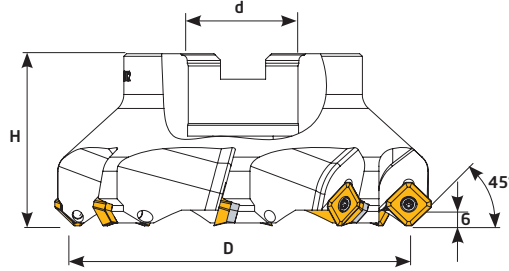

Ölçüler (mm) Dimensions(mm) Abmessungen (mm)		SEET 12T3 R245	
L	S		
13,4	3,97		

Aitlikli - With Shim - Mit U-Platte												
Sipariş Kodu Order Code Best.-Nr.	Stok/Stock/Lager	Ürün Kodu Product Code Produkt-Code	Ölçüler (mm) Dimensions(mm) Abmessungen (mm)					Kullanılan Uç Insert WSP	Sıkma Cıvatası Clamp Screw Torx-Schraube	Aitlik Shim U-Platte	Aitlik Cıvatası Shim Screw Inbuss-Schraube	Anahtar Torx Key Torx-Schlüssel
			D	d	Z	H	kg					
T560	●	D050 d22 Z04 SEET 12	50	22	4	40	0,345	SEET 12T3 R245	TC068 M3,5x11	TA052	TC049 M5x7	T15
T562	●	D063 d22 Z05 SEET 12	63	22	5	40	0,505					
T564	●	D080 d27 Z06 SEET 12	80	27	6	50	1,206					
T566	●	D100 d32 Z07 SEET 12	100	32	7	50	1,812					
T568	●	D125 d40 Z08 SEET 12	125	40	8	63	3,390					
T570	●	D160 d40 Z10 SEET 12	160	40	10	63	4,590					

ZCC -SNDVK-XTC--ucuna uygundur. / Compatible with ZCC -SNDVK-XTC- insert. / Kompatible für ZCC -SNDVK-XTC- WP

● Stokta/ In Stock/ Lager ○ Sınırlı Stok/ Limited Stock/ Begrenzte Lagerhaltung

Kalite için Teknik Çözüm | Technical Solution For Quality

BROTECH

TEKNİK
Cutting Tools

www.teknikcuttingtools.com

9

45° ONMX 0806

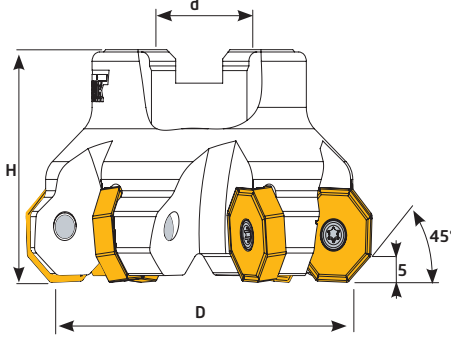

Ölçüler (mm) Dimensions(mm) Abmessungen (mm)			ONMX 0806	
l	d	s		
8,4	20,2	6		

Sipariş Kodu Order Code Best.-Nr.	Stok/Stock/Lager	Ürün Kodu Product Code Produkt-Code	Ölçüler (mm) Dimensions(mm) Abmessungen (mm)					Kullanılan Uç Insert WSP	Sıkma Civatası Clamp Screw Torx-Schraube	Anahtar Torx Key Torx-Schlüssel
			D	d	Z	H				
T780	●	D063 d22 Z05 ONMX 08	63	22	5	40	1,063		TC083 M5x12	
T782	●	D080 d27 Z06 ONMX 08	80	27	6	50	0,532			
T784	●	D100 d32 Z07 ONMX 08	100	32	7	50	1,067			
T786	●	D125 d40 Z08 ONMX 08	125	40	8	63	3,574			

KRLY-ISCR-YG1-LMN ucuna uygundur. / Compatible with KRLY-ISCR-YG1-LMN insert. / Kompatible für KRLY-ISCR-YG1-LMN WP

45° ONMX 0606

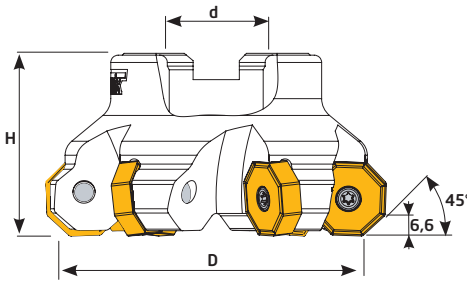

Ölçüler (mm) Dimensions(mm) Abmessungen (mm)			ONMX 0606	
l	d	s		
6,6	16	6		

Sipariş Kodu Order Code Best.-Nr.	Stok/Stock/Lager	Ürün Kodu Product Code Produkt-Code	Ölçüler (mm) Dimensions(mm) Abmessungen (mm)					Kullanılan Uç Insert WSP	Sıkma Civatası Clamp Screw Torx-Schraube	Anahtar Torx Key Torx-Schlüssel
			D	d	Z	H				
T790	●	D063 d22 Z05 ONMX 06	63	22	5	45	0,657		TC083 M5x12	
T791	●	D080 d27 Z06 ONMX 06	80	27	6	50	1,110			
T792	●	D100 d32 Z07 ONMX 06	100	32	7	52	1,701			



KRLY ucuna uygundur. / Compatible with KRLY insert. / Kompatible für KRLY WP

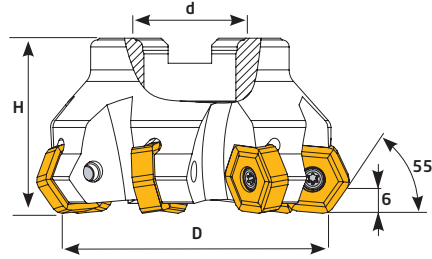

55° HNHX 1006

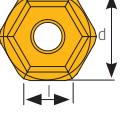

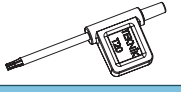

Ölçüler (mm) Dimensions(mm) Abmessungen (mm)			HNHX 1006	
d	l	S		
10	19,05	6,35		



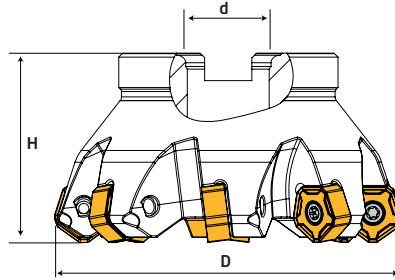

Sipariş Kodu Order Code Best.-Nr.	Stok/Stock/Lager	Ürün Kodu Product Code Produkt-Code	Ölçüler (mm) Dimensions(mm) Abmessungen (mm)					Kullanılan Uç Insert WSP	Sıkma Civatası Clamp Screw Torx-Schraube	Anahtar Torx Key Torx-Schlüssel
			D	d	Z	H				
T470	●	D063 d22 Z05 HNHX 10	63	22	5	50	0,675	HNHX 1006 TGTC	TC083 M5x12	T20
T472	●	D080 d27 Z07 HNHX 10	80	27	7	50	1,063			
T474	●	D100 d32 Z09 HNHX 10	100	32	9	62	2,023			
T476	●	D125 d40 Z10 HNHX 10	125	40	10	62	3,331			
T478	●	D160 d40 Z12 HNHX 10	160	40	12	62	4,724			

TGTC ucuna uygundur. / Compatible with TGTC insert. / Kompatibel für TGTC WP

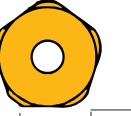
PNMU 1206



Ölçüler (mm) Dimensions(mm) Abmessungen (mm)			PNMU 1206	
l	d	s		
6,75	14	5,82		

Sipariş Kodu Order Code Best.-Nr.	Stok/Stock/Lager	Ürün Kodu Product Code Produkt-Code	Ölçüler (mm) Dimensions(mm) Abmessungen (mm)					Kullanılan Uç Insert WSP	Sıkma Civatası Clamp Screw Torx-Schraube	Anahtar Torx Key Torx-Schlüssel
			D	d	Z	H				
T722	●	D050 d22 Z04 PNMU 12	50	22	4	40	0,371	PNMU 1206 YG1	TC074 M4x10	T15
T723	●	D063 d22 Z05 PNMU 12	63	22	5	40	0,594			
T724	●	D080 d27 Z08 PNMU 12	80	27	8	50	1,273			
T725	●	D100 d32 Z10 PNMU 12	100	32	10	50	1,901			
T726	●	D125 d40 Z10 PNMU 12	125	40	10	63	4,070			

YG1 ucuna uygundur. / Compatible with YG1 insert. / Kompatibel für YG1 WP

● Stokta/In Stock/Lager ○ Sınırlı Stok/Limited Stock/Begrenzte Lagerhaltung

Kalite için Teknik Çözüm | Technical Solution For Quality

BROTECH



TEKNİK
Cutting Tools

www.teknikcuttingtools.com

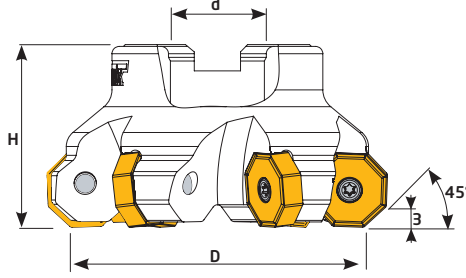
45° ONMU 0505

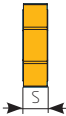
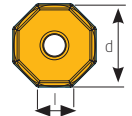

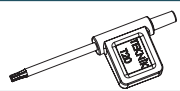

Ölçüler (mm) Dimensions(mm) Abmessungen (mm)			ONMU 0505	
l	d	S		
5	13	5,2		



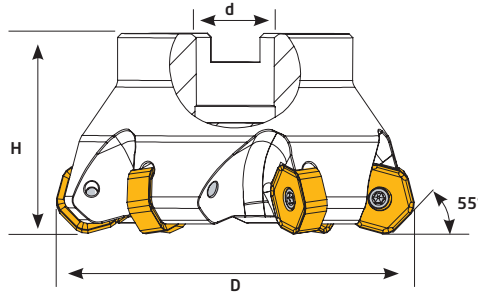

Sipariş Kodu Order Code Best.-Nr.	Stok/Stock/Lager	Ürün Kodu Product Code Produkt-Code	Ölçüler (mm) Dimensions(mm) Abmessungen (mm)					Kullanılan Uç Insert WSP	Sıkma Civatası Clamp Screw Torx-Schraube	Anahtar Torx Key Torx-Schlüssel
			D	d	Z	H				
T794	●	D063 d22 Z06 ONMU 05	63	22	6	45	0,652			
T796	●	D080 d27 Z07 ONMU 05	80	27	7	50	1,202			
T798	●	D100 d32 Z08 ONMU 05	100	32	8	52	1,842			
T800	●	D125 d40 Z10 ONMU 05	125	40	10	62	3,537			
T801	●	D160 d40 Z12 ONMU 05	160	40	12	62	4,863			

ISCR ucuna uygundur. / Compatible with ISCR insert. / Kompatibel für ISCR WP

55° HNGX 0906



Ölçüler (mm) Dimensions(mm) Abmessungen (mm)		HNGX 0906	
d	s		
16,5	6,3		

Sipariş Kodu Order Code Best.-Nr.	Stok/Stock/Lager	Ürün Kodu Product Code Produkt-Code	Ölçüler (mm) Dimensions(mm) Abmessungen (mm)					Kullanılan Uç Insert WSP	Sıkma Civatası Clamp Screw Torx-Schraube	Anahtar Torx Key Torx-Schlüssel
			D	d	Z	H				
T418	●	D063 d22 Z06 HNGX 09	63	22	6	40	0,518			
T419	●	D080 d27 Z06 HNGX 09	80	27	6	50	1,067			
T420	●	D100 d32 Z08 HNGX 09	100	32	8	50	1,542			
T421	●	D125 d40 Z08 HNGX 09	125	40	8	63	3,314			
T422	●	D160 d40 Z12 HNGX 09	160	40	12	63	3,962			

PRMT ucuna uygundur. / Compatible with PRMT insert. / Kompatibel für PRMT WP



43° ODHT 0605

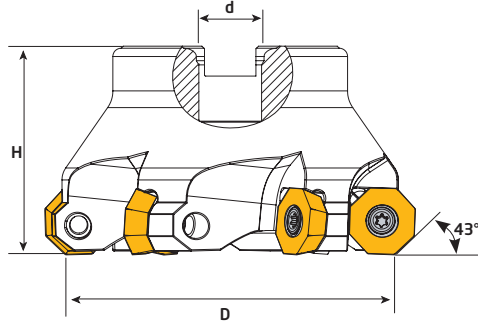

Ölçüler (mm) Dimensions(mm) Abmessungen (mm)			ODHT 0605	
l	d	S		
8	15,88	5,56		

Sipariş Kodu Order Code Best.-Nr.	Stok/Stock/Lager	Ürün Kodu Product Code Produkt-Code	Ölçüler (mm) Dimensions(mm) Abmessungen (mm)					Kullanılan Uç Insert WSP	Sıkma Civatası Clamp Screw Torx-Schraube	Anahtar Torx Key Torx-Schlüssel
			D	d	Z	H				
T210	●	D063 d22 Z05 ODHT 06	63	22	5	40	0,610	ODHT 0605 WLTR	TC083 M5x12	T20
T211	●	D080 d27 Z06 ODHT 06	80	27	6	50	1,070			
T212	●	D100 d32 Z07 ODHT 06	100	32	7	52	1,765			
T213	●	D125 d40 Z08 ODHT 06	125	40	8	62	3,528			

WLTR ucuna uygundur. / Compatible with WLTR insert. / Kompatible für WLTR WP

43° OFCR 0704

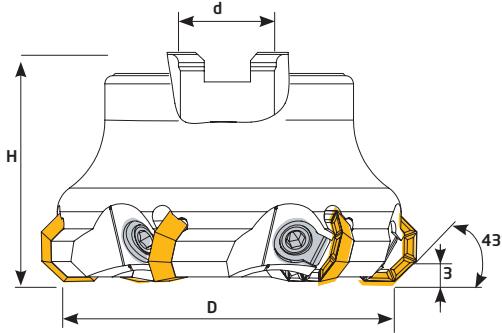

Ölçüler (mm) Dimensions(mm) Abmessungen (mm)			OFCR 0704	
l	d	S		
7	18	4,97		

Sipariş Kodu Order Code Best.-Nr.	Stok/Stock/Lager	Ürün Kodu Product Code Produkt-Code	Ölçüler (mm) Dimensions(mm) Abmessungen (mm)					Kullanılan Uç Insert WSP	Baskı Kepi Clamp Spannpratze	Baskı Civatası Locking Screw Verriegelungs- schraub	Anahtar Allen Key Inbusschlüssel
			D	d	Z	H					
T260	●	D050 d22 Z04 OFCR 07	50	22	4	45	0,488	OFCR 0704 ISO	BK300	TC300 M8x18	4 Allen
T262	●	D063 d22 Z04 OFCR 07	63	22	4	45	0,722				
T264	●	D080 d27 Z06 OFCR 07	80	27	6	50	1,205				
T266	●	D100 d32 Z08 OFCR 07	100	32	8	50	1,654				
T268	●	D125 d40 Z09 OFCR 07	125	40	9	62	3,510				
T269	●	D160 d40 Z12 OFCR 07	160	40	12	62	5,112				

● Stokta/ In Stock/ Lager ○ Sınırlı Stok/ Limited Stock/ Begrenzte Lagerhaltung

Kalite için Teknik Çözüm | Technical Solution For Quality

90° XNEX 0806

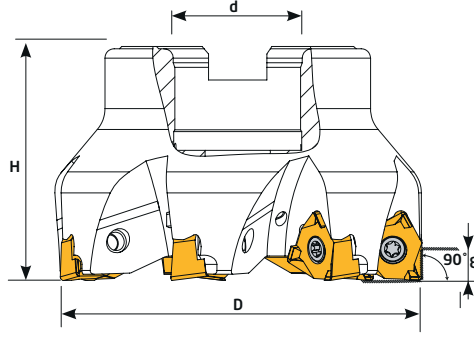

Ölçüler (mm) Dimensions(mm) Abmessungen (mm)			XNEX 0806	
d	l	s		
12,48	8	6,47		

Sipariş Kodu Order Code Best.-Nr.	Stok/Stock/Lager	Ürün Kodu Product Code Produkt-Code	Ölçüler (mm) Dimensions(mm) Abmessungen (mm)					Kullanılan Uç Insert WSP	Sıkma Cıvatası Clamp Screw Torx-Schraube	Anahtar Torx Key Torx-Schlüssel
			D	d	Z	H				
T840	●	D050 d22 Z04 XNEX 08	50	22	4	45	0,400			
T841	●	D050 d22 Z05 XNEX 08	50	22	5	45	0,394			
T842	●	D063 d22 Z06 XNEX 08	63	22	6	45	0,490			
T844	●	D080 d27 Z07 XNEX 08	80	27	7	50	1,063			
T846	●	D100 d32 Z07 XNEX 08	100	32	7	52	1,755			
T848	●	D125 d40 Z10 XNEX 08	125	40	10	60	3,155			
T850	●	D160 d40 Z12 XNEX 08	160	40	12	63	5,154			
T851	●	D200 d60 Z14 XNEX 08	200	60	14	63	6,415			

SCO-WNST uclarına uygundur. / Compatible with SCO-WNST inserts. / Kompatible für SCO-WNST WP

90° WNGX 0806

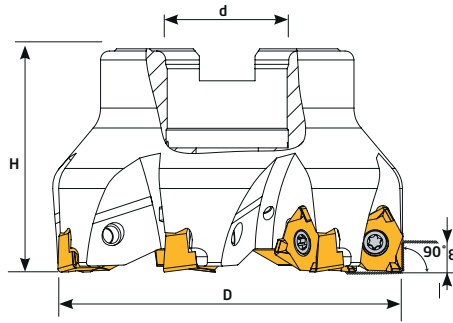

Ölçüler (mm) Dimensions(mm) Abmessungen (mm)			WNGX 0806	
l	d	s		
8,2	13	6,4		

Sipariş Kodu Order Code Best.-Nr.	Stok/Stock/Lager	Ürün Kodu Product Code Produkt-Code	Ölçüler (mm) Dimensions(mm) Abmessungen (mm)					Kullanılan Uç Insert WSP	Sıkma Cıvatası Clamp Screw Torx-Schraube	Anahtar Torx Key Torx-Schlüssel
			D	d	Z	H				
T775	●	D050 d22 Z05 WNGX 08	50	22	5	40	0,277			
T776	●	D063 d22 Z06 WNGX 08	63	22	6	40	0,470			
T777	●	D080 d27 Z07 WNGX 08	80	27	7	50	1,105			
T778	●	D100 d32 Z08 WNGX 08	100	32	8	52	1,580			

KRLY ucuna uygundur. / Compatible with KRLY insert. / Kompatible für KRLY WP



90° WNGX 0403

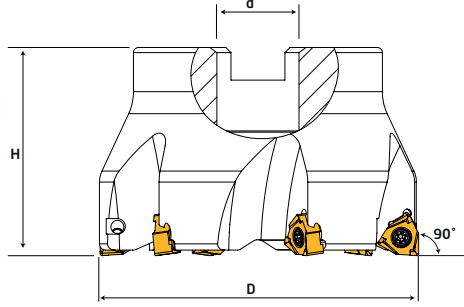

Ölçüler (mm) Dimensions(mm) Abmessungen (mm)			WNGX 0403	
l	d	s		
4,3	7	3,46		

Sipariş Kodu Order Code Best.-Nr.	Stok/Stock/Lager	Ürün Kodu Product Code Produkt-Code	Ölçüler (mm) Dimensions(mm) Abmessungen (mm)					Kullanılan Uç Insert WSP	Sıkma Civatası Clamp Screw Torx-Schraube	Anahtar Torx Key Torx-Schlüssel
			D	d	Z	H	kg			
T692	●	D040 d16 Z06 WNGX 04	40	16	6	40	0,256	WNGX 0403 KRLY	TC060 M2,5x5,5	T8
T693	●	D050 d22 Z08 WNGX 04	50	22	8	40	0,347			
T694	●	D063 d22 Z10 WNGX 04	63	22	10	40	0,617			
T695	●	D080 d27 Z11 WNGX 04	80	27	11	50	1,306			

KRLY ucuna uygundur. / Compatible with KRLY insert. / Kompatible für KRLY WP

90° WNMU 0705

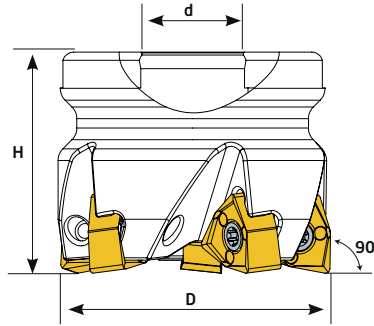
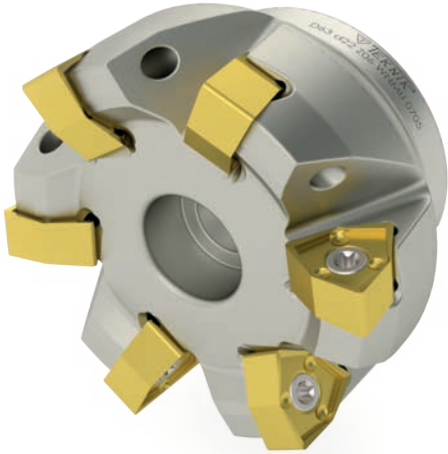

Ölçüler (mm) Dimensions(mm) Abmessungen (mm)			WNMU 0705	
l	d	s		
7,15	11,5	5,7		

Sipariş Kodu Order Code Best.-Nr.	Stok/Stock/Lager	Ürün Kodu Product Code Produkt-Code	Ölçüler (mm) Dimensions(mm) Abmessungen (mm)					Kullanılan Uç Insert /WSP	Sıkma Civatası Clamp Scr /Torx-Schraube	Anahtar Torx Key / Torx-Schlüssel
			D	d	Z	H	kg			
T392	●	D050 d22 Z05 WNMU 07	50	22	5	40	0,337	WNMU 0705 ISCR	TC074 M4x10	T15
T393	●	D063 d22 Z06 WNMU 07	63	22	6	40	0,515			
T394	●	D080 d27 Z07 WNMU 07	80	27	7	50	1,012			
T395	●	D100 d32 Z08 WNMU 07	100	32	8	50	1,342			

ISCR ucuna uygundur. / Compatible with ISCR insert. / Kompatible für ISCR WP

90° WNMU 0806

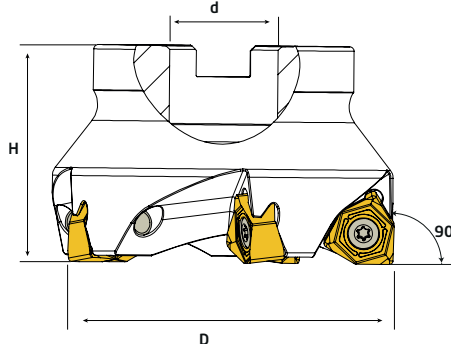

Ölçüler (mm) Dimensions(mm) Abmessungen (mm)			WNMU 0806	
l	d	S		
8,2	13	6,4		

Sipariş Kodu Order Code Best.-Nr.	Stok/Stock/Lager	Ürün Kodu Product Code Produkt-Code	Ölçüler (mm) Dimensions(mm) Abmessungen (mm)					Kullanılan Uç Insert WSP	Sıkma Cıvatası Clamp Screw Torx-Schraube	Anahtar Torx Key Torx-Schlüssel
			D	d	Z	H				
T543	●	D050 d22 Z03 WNMU 08	50	22	3	46	0,360			
T544	●	D063 d22 Z04 WNMU 08	63	22	4	46	0,556			
T545	●	D080 d27 Z05 WNMU 08	80	27	5	50	1,016			
T546	●	D100 d32 Z06 WNMU 08	100	32	6	50	1,360			

KYCRA ucuna uygundur. / Compatible with KYCRA insert. / Kompatibel für KYCRA WP

88° SNMX 1206

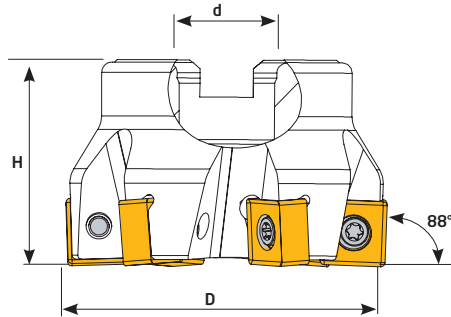
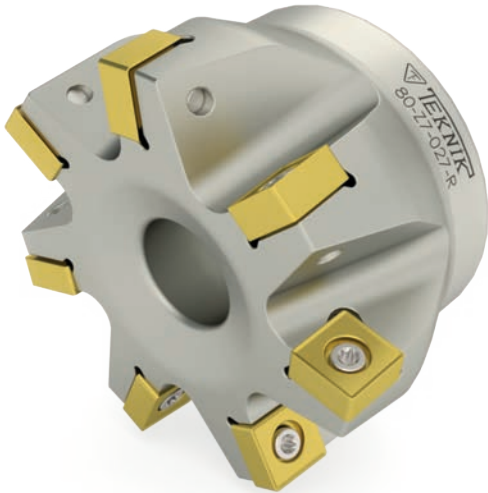

Ölçüler (mm) Dimensions(mm) Abmessungen (mm)				SNMX 1206	
L	s	r	d1		
12,7	6,35	0,80	4,5		

Sipariş Kodu Order Code Best.-Nr.	Stok/Stock/Lager	Ürün Kodu Product Code Produkt-Code	Ölçüler (mm) Dimensions(mm) Abmessungen (mm)					Kullanılan Uç Insert WSP	Sıkma Cıvatası Clamp Screw Torx-Schraube	Anahtar Torx Key Torx-Schlüssel
			D	d	Z	H				
T344	●	D063 d22 Z06 SNMX 12	63	22	6	40	0,574			
T345	●	D080 d27 Z07 SNMX 12	80	27	7	50	1,213			
T346	●	D100 d32 Z08 SNMX 12	100	32	8	50	1,688			



KRLY ucuna uygundur. / Compatible with KRLY insert. / Kompatibel für KRLY WP

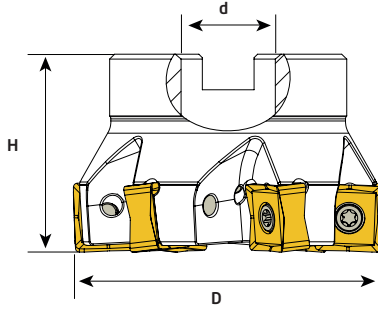

90° SNHU 1206

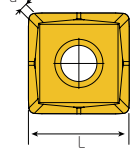
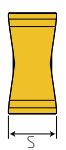

Ölçüler (mm) Dimensions(mm) Abmessungen (mm)			SNHU 1206	
L	S	a		
13,3	6,4	1		

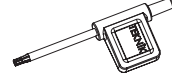

Sipariş Kodu Order Code Best.-Nr.	Stok/Stock/Lager	Ürün Kodu Product Code Produkt-Code	Ölçüler (mm) Dimensions(mm) Abmessungen (mm)					Kullanılan Uç Insert WSP	Sıkma Cıvatası Clamp Screw Torx-Schraube	Anahtar Torx Key Torx-Schlüssel
			D	d	Z	H				
T616	●	D050 d22 Z04 SNHU 12	50	22	4	40	0,298			
T617	●	D050 d22 Z05 SNHU 12	50	22	5	40	0,305			
T617-1	●	D063 d22 Z05 SNHU 12	63	22	5	40	0,472			
T618	●	D063 d22 Z06 SNHU 12	63	22	6	40	0,503			
T618-1	●	D080 d27 Z06 SNHU 12	80	27	6	50	0,968			
T619	●	D080 d27 Z07 SNHU 12	80	27	7	50	1,076			
T620	●	D100 d32 Z08 SNHU 12	100	32	8	50	1,459			
T621	●	D125 d40 Z10 SNHU 12	125	40	10	63	2,708			
T622	●	D160 d40 Z12 SNHU 12	160	40	12	63	4,328			

PLBT ucuna uygundur. / Compatible with PLBT insert. / Kompatible für PLBT WP

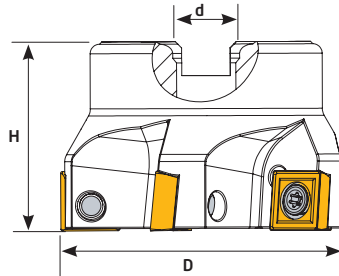
90° SPMT 1204

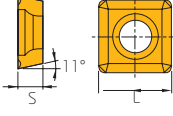
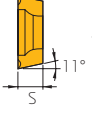

Ölçüler (mm) Dimensions(mm) Abmessungen (mm)			SPMT 1204	
L	S			
12,70	4,76			

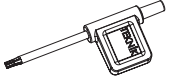
Sipariş Kodu Order Code Best.-Nr.	Stok/Stock/Lager	Ürün Kodu Product Code Produkt-Code	Ölçüler (mm) Dimensions(mm) Abmessungen (mm)					Kullanılan Uç Insert WSP	Sıkma Cıvatası Clamp Screw Torx-Schraube	Anahtar Torx Key Torx-Schlüssel
			D	d	Z	H				
T649	●	D040 d16 Z03 SPMT 12	40	16	3	40	0,253			
T650	●	D050 d22 Z04 SPMT 12	50	22	4	40	0,362			
T651	●	D063 d22 Z05 SPMT 12	63	22	5	50	0,772			
T652	●	D080 d27 Z06 SPMT 12	80	27	6	50	1,186			
T653	●	D100 d32 Z08 SPMT 12	100	32	8	50	1,786			
T654	●	D125 d40 Z08 SPMT 12	125	40	8	63	2,935			
T655	●	D160 d40 Z10 SPMT 12	160	40	10	63	3,980			

PLBT -ZCC-WLTR-ucuna uygundur. / Compatible with PLBT -ZCC-WLTR insert. / Kompatible für PLBT -ZCC-WLTR WP

● Stokta/ In Stock/ Lager ○ Sınırlı Stok/ Limited Stock/ Begrenzte Lagerhaltung

Kalite için Teknik Çözüm | Technical Solution For Quality

BROTECH

TEKNİK
Cutting Tools

www.teknikcuttingtools.com

90° SPMG 0904

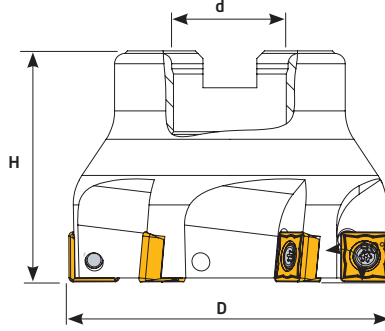

Ölçüler (mm) Dimensions(mm) Abmessungen (mm)		SPMG 0904	
L	S		
9,8	4,3		

Sipariş Kodu Order Code Best.-Nr.	Stok/Stock/Lager	Ürün Kodu Product Code Produkt-Code	Ölçüler (mm) Dimensions(mm) Abmessungen (mm)					Kullanılan Uç Insert WSP	Sıkma Cıvatası Clamp Screw Torx-Schraube	Anahtar Torx Key Torx-Schlüssel
			D	d	Z	H	kg			
T338	●	D050 d22 Z05 SPMG 09	50	22	5	45	0,239	SPMG 0904 TGTC	TC067 M3,5x8,5	T15
T340	●	D063 d22 Z06 SPMG 09	63	22	6	45	0,362			
T342	●	D080 d27 Z07 SPMG 09	80	27	7	52	1,088			

TGTC ucuna uygundur. / Compatible with TGTC insert. / Kompatible für TGTC WP

90° LNMX 1006

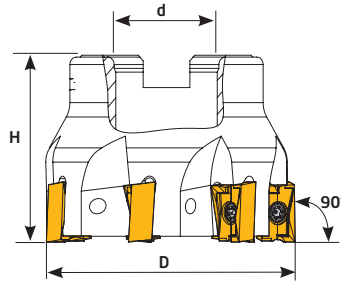

Ölçüler (mm) Dimensions(mm) Abmessungen (mm)			LNMX 1006	
L	S	A		
10	6,5	6,35		

Sipariş Kodu Order Code Best.-Nr.	Stok/Stock/Lager	Ürün Kodu Product Code Produkt-Code	Ölçüler (mm) Dimensions(mm) Abmessungen (mm)					Kullanılan Uç Insert WSP	Sıkma Cıvatası Clamp Screw Torx-Schraube	Anahtar Torx Key Torx-Schlüssel
			D	d	Z	H	kg			
T386	●	D040 d16 Z05 LNMX 10	40	16	5	40	0,258	LNMX 1006 KRLY	TC065 M3x7	T8
T387	●	D050 d22 Z06 LNMX 10	50	22	6	45	0,472			
T388	●	D063 d22 Z06 LNMX 10	63	22	6	45	0,495			
T389	●	D080 d27 Z07 LNMX 10	80	27	7	50	0,731			
T390	●	D100 d32 Z09 LNMX 10	100	32	9	50	1,700			

KRLY ucuna uygundur. / Compatible with KRLY insert. / Kompatible für KRLY WP



90° LNMX 1510

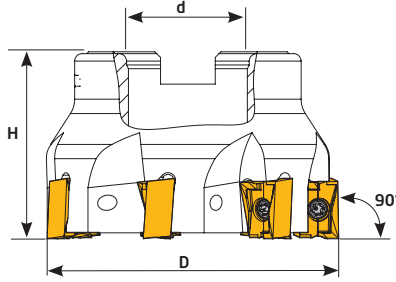

Ölçüler (mm) Dimensions(mm) Abmessungen (mm)			LNMX 1510	
L	S	A		
15	10	10		

Sipariş Kodu Order Code Best.-Nr.	Stok/Stock/Lager	Ürün Kodu Product Code Produkt-Code	Ölçüler (mm) Dimensions(mm) Abmessungen (mm)					Kullanılan Uç Insert WSP	Sıkma Civatası Clamp Screw Torx-Schraube	Anahtar Torx Key Torx-Schlüssel
			D	d	Z	H				
T372	●	D050 d22 Z04 LNMX 15	50	22	4	45	0,375			
T374	●	D063 d22 Z06 LNMX 15	63	22	6	45	0,616			
T376	●	D080 d27 Z07 LNMX 15	80	27	7	50	1,087			
T378	●	D100 d32 Z08 LNMX 15	100	32	8	52	1,644			
T380	●	D125 d40 Z10 LNMX 15	125	40	10	63	3,650			

KRLY ucuna uygundur. / Compatible with KRLY insert. / Kompatible für KRLY WP

90° ANKX 1205

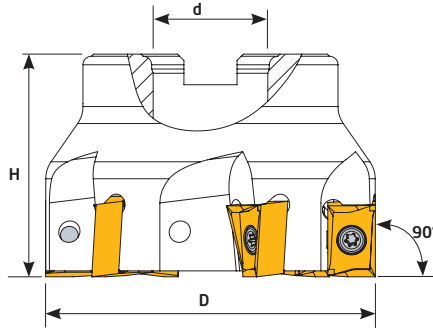

Ölçüler (mm) Dimensions(mm) Abmessungen (mm)			ANKX 1205	
L	S	A		
13,7	9,15	9,7		

Sipariş Kodu Order Code Best.-Nr.	Stok/Stock/Lager	Ürün Kodu Product Code Produkt-Code	Ölçüler (mm) Dimensions(mm) Abmessungen (mm)					Kullanılan Uç Insert WSP	Sıkma Civatası Clamp Screw Torx-Schraube	Anahtar Torx Key Torx-Schlüssel
			D	d	Z	H				
T571	●	D040 d16 Z04 ANKX 12	40	16	4	40	0,215			
T572	●	D050 d22 Z05 ANKX 12	50	22	5	45	0,433			
T574	●	D063 d22 Z06 ANKX 12	63	22	6	45	0,596			
T576	●	D080 d27 Z07 ANKX 12	80	27	7	50	1,210			

ISCR ucuna uygundur. / Compatible with ISCR insert. / Kompatible für ISCR WP

● Stokta/ In Stock/ Lager ○ Sınırlı Stok/ Limited Stock/ Begrenzte Lagerhaltung

Kalite için Teknik Çözüm | Technical Solution For Quality

BROTECH

TEKNİK
Cutting Tools

www.teknikcuttingtools.com

90° ANKX 1706

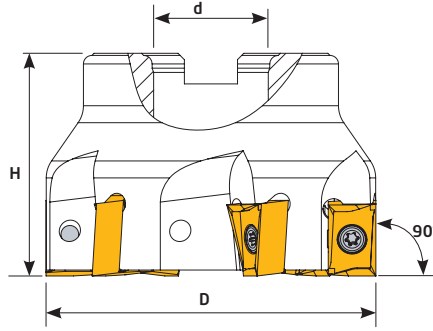

Ölçüler (mm) Dimensions(mm) Abmessungen (mm)			ANKX 1706	
L	S	A		
16,7	10,4	11,2		

Sipariş Kodu Order Code Best.-Nr.	Stok/Stock/Lager	Ürün Kodu Product Code Produkt-Code	Ölçüler (mm) Dimensions(mm) Abmessungen (mm)					Kullanılan Uç Insert WSP	Sıkma Cıvatası Clamp Screw Torx-Schraube	Anahtar Torx Key Torx-Schlüssel
			D	d	Z	H				
T440	●	D040 d16 Z03 ANKX 17	40	16	3	45	0,279			
T442	●	D050 d22 Z04 ANKX 17	50	22	4	45	0,371			
T444	●	D063 d22 Z05 ANKX 17	63	22	5	45	0,573			
T446	●	D080 d27 Z06 ANKX 17	80	27	6	52	1,238			
T448	●	D100 d32 Z07 ANKX 17	100	32	7	52	2,029			
T450	●	D125 d40 Z08 ANKX 17	125	40	8	63	3,590			

ISCR ucuna uygundur. / Compatible with ISCR insert. / Kompatible für ISCR WP

90° ANHX 1004

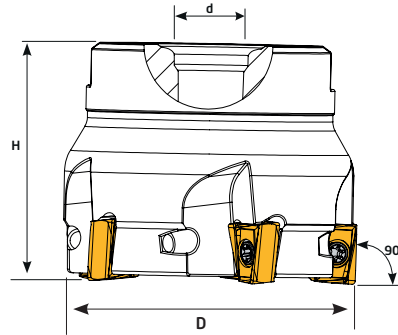

Ölçüler (mm) Dimensions(mm) Abmessungen (mm)			ANHX 1004	
A	S	L		
6,6	6,2	10		

Sipariş Kodu Order Code Best.-Nr.	Stok/Stock/Lager	Ürün Kodu Product Code Produkt-Code	Ölçüler (mm) Dimensions(mm) Abmessungen (mm)					Kullanılan Uç Insert WSP	Sıkma Cıvatası Clamp Screw Torx-Schraube	Anahtar Torx Key Torx-Schlüssel
			D	d	Z	H				
T656	●	D040 d16 Z04 ANHX 10	40	16	4	40	0,250			
T657	●	D050 d22 Z05 ANHX 10	50	22	5	40	0,374			
T658	●	D063 d22 Z07 ANHX 10	63	22	7	40	0,638			
T659	●	D080 d27 Z08 ANHX 10	80	27	8	50	1,132			

PLBT ucuna uygundur. / Compatible with PLBT insert. / Kompatible für PLBT WP



90° ANHX 1206

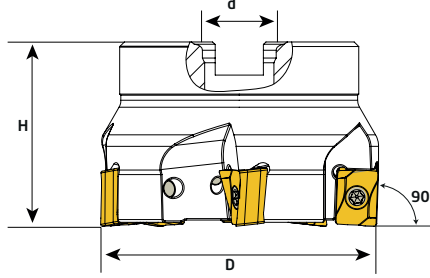

Ölçüler (mm) Dimensions(mm) Abmessungen (mm)			ANHX 1206	
L	S	A		
12	8,3	9		

Sipariş Kodu Order Code Best.-Nr.	Stok/Stock/Lager	Ürün Kodu Product Code Produkt-Code	Ölçüler (mm) Dimensions(mm) Abmessungen (mm)					Kullanılan Uç Insert WSP	Sıkma Civatası Clamp Screw Torx-Schraube	Anahtar Torx Key Torx-Schlüssel
			D	d	Z	H				
T641	●	D040 d16 Z04 ANHX 12	40	16	4	40	0,248			
T642	●	D050 d22 Z05 ANHX 12	50	22	5	40	0,375			
T643	●	D063 d22 Z05 ANHX 12	63	27	5	40	0,619			
T644	●	D080 d27 Z08 ANHX 12	80	27	8	50	1,209			
T645	●	D100 d32 Z12 ANHX 12	100	32	12	50	1,761			
T646	●	D125 d40 Z14 ANHX 12	125	40	14	63	3,091			

PLBT ucuna uygundur. / Compatible with PLBT insert. / Kompatible für PLBT WP

90° ANKX 1607

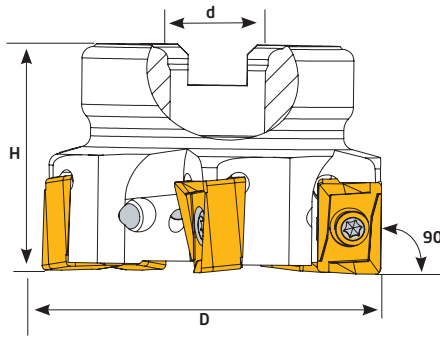

Ölçüler (mm) Dimensions(mm) Abmessungen (mm)				ANKX 1607	
L	s	a	d1		
12,7	6,35	2,2	6		

Sipariş Kodu Order Code Best.-Nr.	Stok/Stock/Lager	Ürün Kodu Product Code Produkt-Code	Ölçüler (mm) Dimensions(mm) Abmessungen (mm)					Kullanılan Uç Insert WSP	Sıkma Civatası Clamp Screw Torx-Schraube	Anahtar Torx Key Torx-Schlüssel
			D	d	Z	H				
T171	●	D050 d22 Z04 ANKX 16	50	22	4	40	0,307			
T172	●	D063 d22 Z05 ANKX 16	63	22	5	40	0,462			
T173	●	D080 d27 Z06 ANKX 16	80	27	6	50	1,101			

XTC- GSC ucuna uygundur. / Compatible with XTC- GSC insert. / Kompatible für XTC- GSC WP

● Stokta/ In Stock/ Lager ○ Sınırlı Stok/ Limited Stock/ Begrenzte Lagerhaltung

Kalite için Teknik Çözüm | Technical Solution For Quality



90° LNGX 1307

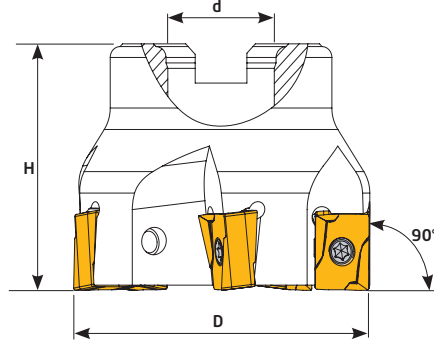

Ölçüler (mm) Dimensions(mm) Abmessungen (mm)			LNGX 1307
A	L	S	
11	14	7,74	

Sipariş Kodu Order Code Best.-Nr.	Stok/Stock/Lager	Ürün Kodu Product Code Produkt-Code	Ölçüler (mm) Dimensions(mm) Abmessungen (mm)					Kullanılan Uç Insert WSP	Sıkma Cıvatası Clamp Screw Torx-Schraube	Anahtar Torx Key Torx-Schlüssel
			D	d	Z	H				
T488	●	D040 d16 Z03 LNGX 13	40	16	3	45	0,304			
T490	●	D050 d22 Z04 LNGX 13	50	22	4	45	0,425			
T492	●	D063 d22 Z06 LNGX 13	63	22	6	45	0,560			
T493	●	D080 d27 Z07 LNGX 13	80	27	7	50	1,124			
T494	●	D100 d32 Z07 LNGX 13	100	32	7	50	1,542			
T495	●	D125 d40 Z08 LNGX 13	125	40	8	63	3,555			

WLTR ucuna uygundur. / Compatible with WLTR insert. / Kompatible für WLTR WP

90° LNGU 15T6

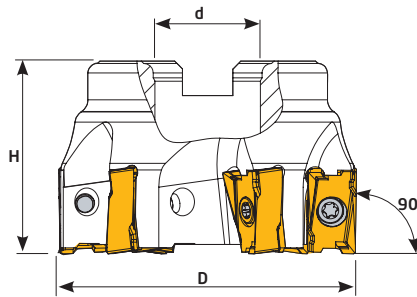

Ölçüler (mm) Dimensions(mm) Abmessungen (mm)			LNGU 15T6
L	S	A	
17	9,69	10	

Sipariş Kodu Order Code Best.-Nr.	Stok/Stock/Lager	Ürün Kodu Product Code Produkt-Code	Ölçüler (mm) Dimensions(mm) Abmessungen (mm)					Kullanılan Uç Insert WSP	Sıkma Cıvatası Clamp Screw Torx-Schraube	Anahtar Torx Key Torx-Schlüssel
			D	d	Z	H				
T956	●	D050 d22 Z05 LNGU 15	50	22	5	40	0,305			
T958	●	D063 d22 Z06 LNGU 15	63	22	6	40	0,541			
T960	●	D080 d27 Z07 LNGU 15	80	27	7	50	1,133			
T961	○	D100 d32 Z08 LNGU 15	100	32	8	50	1,933			



KNNMTL ucuna uygundur. / Compatible with KNNMTL insert. / Kompatible für KNNMTL WP

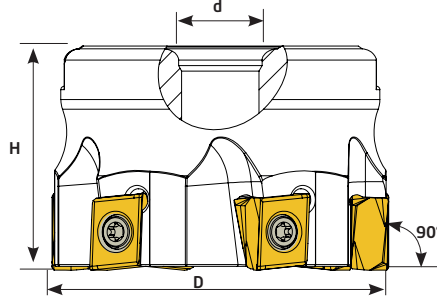

90° LNHU 1306

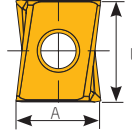

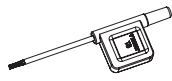

Ölçüler (mm) Dimensions(mm) Abmessungen (mm)			LNHU 1306	
L	S	A		
13	6,8	12		

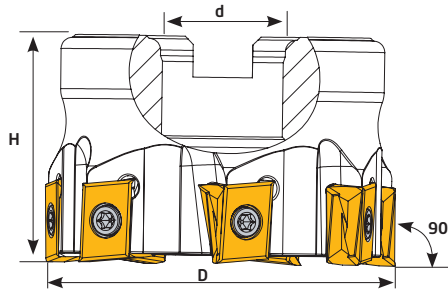
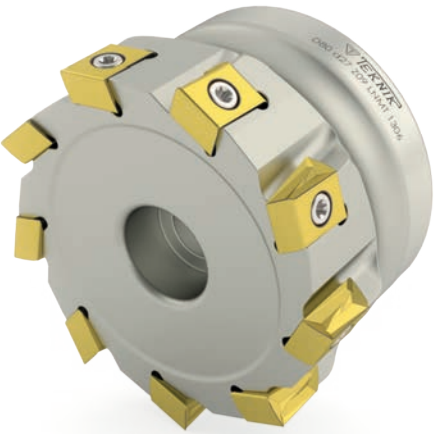

Sipariş Kodu Order Code Best.-Nr.	Stok/Stock/Lager	Ürün Kodu Product Code Produkt-Code	Ölçüler (mm) Dimensions(mm) Abmessungen (mm)					Kullanılan Uç Insert WSP	Sıkma Cıvatası Clamp Screw Torx-Schraube	Anahtar Torx Key Torx-Schlüssel
			D	d	Z	H				
T580	●	D050 d22 Z05 LNHU 13	50	22	5	40	0,350			
T581	●	D063 d22 Z06 LNHU 13	63	22	6	40	0,628			
T582	●	D080 d27 Z07 LNHU 13	80	27	7	50	1,315			
T583	●	D100 d32 Z08 LNHU 13	100	32	8	50	1,795			

WLTR ucuna uygundur. / Compatible with WLTR insert. / Kompatible für WLTR WP

90° LNMT 1306

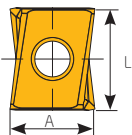

Ölçüler (mm) Dimensions(mm) Abmessungen (mm)			LNMT 1306	
L	S	A		
13,81	6,65	13,05		

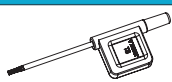
Sipariş Kodu Order Code Best.-Nr.	Stok/Stock/Lager	Ürün Kodu Product Code Produkt-Code	Ölçüler (mm) Dimensions(mm) Abmessungen (mm)					Kullanılan Uç Insert WSP	Sıkma Cıvatası Clamp Screw Torx-Schraube	Anahtar Torx Key Torx-Schlüssel
			D	d	Z	H				
T228	●	D050 d22 Z05 LNMT 13	50	22	5	40	0,337			
T229	●	D063 d22 Z06 LNMT 13	63	22	6	40	0,596			
T230	●	D080 d27 Z07 LNMT 13	80	27	7	50	1,227			
T231	●	D100 d32 Z08 LNMT 13	100	32	8	50	1,682			
T232	●	D125 d40 Z09 LNMT 13	125	40	9	63	3,325			
T233	●	D160 d40 Z12 LNMT 13	160	40	12	63	5,046			

ISCR ucuna uygundur. / Compatible with ISCR insert. / Kompatible für ISCR WP

● Stokta/ In Stock/ Lager ○ Sınırlı Stok/ Limited Stock/ Begrenzte Lagerhaltung

Kalite için Teknik Çözüm | Technical Solution For Quality

BROTECH

TEKNİK
Cutting Tools

www.teknikcuttingtools.com

23

90° LNMT 0804

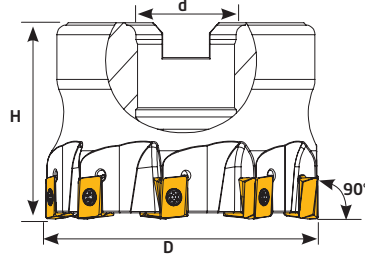

Ölçüler (mm) Dimensions(mm) Abmessungen (mm)			LNMT 0804	
L	S	A		
8,59	4,24	7,43		

Sipariş Kodu Order Code Best.-Nr.	Stok/Stock	Ürün Kodu Product Code Produkt-Code	Ölçüler (mm) Dimensions-Abmessungen (mm)					Kullanılan Uç Insert -WSP	Sıkma Cıvatası Clamp Screw -Torx-Schraube	Anahtar Torx Key-Torx-Schlüssel
			D	d	Z	H	kg			
T222	●	D040 d16 Z06 LNMT 08	40	16	6	40	0,240	LNMT 0804 ISCR		
T223	●	D050 d22 Z07 LNMT 08	50	22	7	40	0,374			
T224	●	D063 d22 Z09 LNMT 08	63	22	9	40	0,665			
T225	●	D080 d27 Z10 LNMT 08	80	27	10	50	1,145			

ISCR ucuna uygundur. / Compatible with ISCR insert. / Kompatibel für ISCR WP

90° LNXT 1306

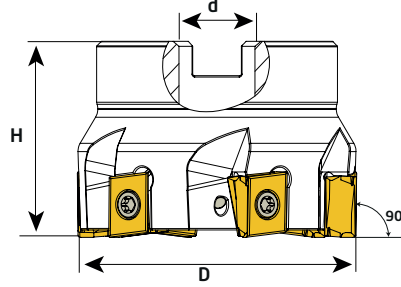

Ölçüler (mm) Dimensions(mm) Abmessungen (mm)			LNXT 1306	
L	S	A		
13	6,8	9,8		

Sipariş Kodu Order Code Best.-Nr.	Stok/Stock	Ürün Kodu Product Code Produkt-Code	Ölçüler (mm) Dimensions-Abmessungen (mm)					Kullanılan Uç Insert -WSP	Sıkma Cıvatası Clamp Screw -Torx-Schraube	Anahtar Torx Key-Torx-Schlüssel
			D	d	Z	H	kg			
T672	●	D040 d16 Z04 LNXT 13	40	16	4	40	0,225	LNXT 1306 PLBT		
T673	●	D050 d22 Z05 LNXT 13	50	22	5	40	0,358			
T674	●	D063 d22 Z06 LNXT 13	63	22	6	40	0,604			
T675	●	D080 d27 Z07 LNXT 13	80	27	7	50	1,029			
T676	●	D100 d32 Z08 LNXT 13	100	32	8	50	1,733			

PLBT ucuna uygundur. / Compatible with PLBT insert. / Kompatibel für PLBT WP

90° LOEX 1207

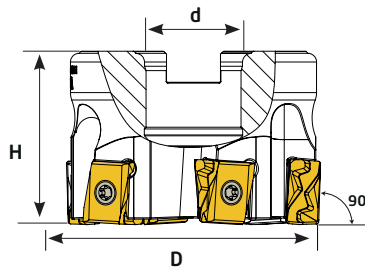

Ölçüler (mm) Dimensions(mm) Abmessungen (mm)			LOEX 1207	
L	S	A		
12	7,5	10,26		

Sipariş Kodu Order Code Best.-Nr.	Stok/Stock	Ürün Kodu Product Code Produkt-Code	Ölçüler (mm) Dimensions-Abmessungen (mm)					Kullanılan Uç Insert -WSP	Sıkma Cıvatası Clamp Screw -Torx-Schraube	Anahtar Torx Key-Torx-Schlüssel
			D	d	Z	H	kg			
T586	●	D050 d22 Z05 LOEX12	50	22	5	40	0,358	LOEX 1207 SCO		
T587	●	D063 d22 Z06 LOEX12	63	22	6	40	0,604			
T588	●	D080 d27 Z07 LOEX12	80	27	7	50	1,029			

SCO ucuna uygundur. / Compatible with SCO insert. / Kompatibel für SCO WP

● Stokta/In Stock/Lager ○ Sınırlı Stok/Limited Stock/Begrenzte Lagerhaltung



90° XNKT 0805

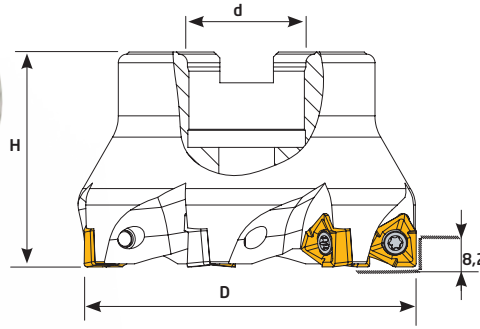

Ölçüler (mm) Dimensions(mm) Abmessungen (mm)			XNKT 0805	
d	l	s		
10	8,2	5,5		

Sipariş Kodu Order Code Best.-Nr.	Stok/Stock/Lager	Ürün Kodu Product Code Produkt-Code	Ölçüler (mm) Dimensions(mm) Abmessungen (mm)					Kullanılan Uç Insert WSP	Sıkma Civatası Clamp Screw Torx-Schraube	Anahtar Torx Key Torx-Schlüssel
			D	d	Z	H	kg			
T900	●	D040 d16 Z04 XNKT 08	40	16	4	45	0,296	XNKT 0805 KRLY	TC072 M4x10	T15
T902	●	D050 d22 Z05 XNKT 08	50	22	5	45	0,396			
T904	●	D063 d22 Z06 XNKT 08	63	22	6	45	0,575			
T906	●	D080 d27 Z07 XNKT 08	80	27	7	50	1,015			
T907	●	D100 d40 Z08 XNKT 08	100	40	8	52	1,575			

KRLY ucuna uygundur. / Compatible with KRLY insert. / Kompatible für KRLY WP

90° XNKT 0604

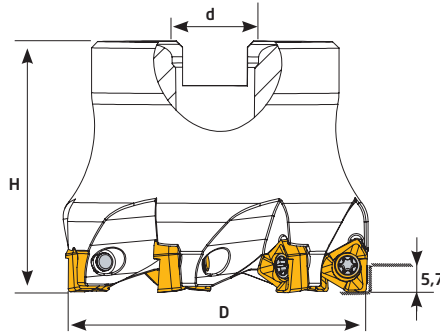

Ölçüler (mm) Dimensions(mm) Abmessungen (mm)			XNKT 0604	
d	l	s		
6,5	5,7	4		

Sipariş Kodu Order Code Best.-Nr.	Stok/Stock/Lager	Ürün Kodu Product Code Produkt-Code	Ölçüler (mm) Dimensions(mm) Abmessungen (mm)					Kullanılan Uç Insert WSP	Sıkma Civatası Clamp Screw Torx-Schraube	Anahtar Torx Key Torx-Schlüssel
			D	d	Z	H	kg			
T852	●	D032 d16 Z04 XNKT 06	32	16	4	40	0,150	XNKT 0604 KRLY	TC065-1 M3x7	T8
T853	●	D040 d16 Z06 XNKT 06	40	16	6	40	0,219			
T854	●	D050 d22 Z07 XNKT 06	50	22	7	40	0,348			
T855	●	D063 d22 Z08 XNKT 06	63	22	8	40	0,527			
T856	●	D080 d27 Z10 XNKT 06	80	27	10	50	0,938			

KRLY ucuna uygundur. / Compatible with KRLY insert. / Kompatible für KRLY WP

● Stokta/ In Stock/ Lager ○ Sınırlı Stok/ Limited Stock/ Begrenzte Lagerhaltung

Kalite için Teknik Çözüm | Technical Solution For Quality

BROTECH

TEKNİK
Cutting Tools

www.teknikcuttingtools.com

25

90° 3PKT 1505

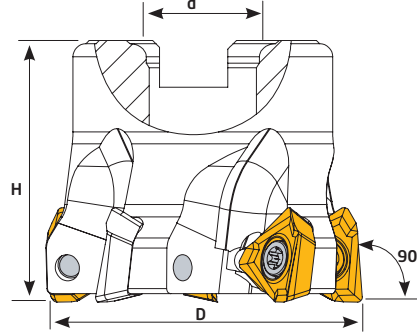

Ölçüler (mm) Dimensions(mm) Abmessungen (mm)			3PKT 1505	
d	l	S		
10,7	11	5		

Sipariş Kodu Order Code Best.-Nr.	Stok/Stock/Lager	Ürün Kodu Product Code Produkt-Code	Ölçüler (mm) Dimensions(mm) Abmessungen (mm)					Kullanılan Uç Insert WSP	Sıkma Civatası Clamp Screw Torx-Schraube	Anahtar Torx Key Torx-Schlüssel
			D	d	Z	H				
T398	●	D050 d22 Z05 3PKT 15	50	22	5	40	0,325			
T399	●	D063 d22 Z06 3PKT 15	63	22	6	40	0,490			
T400	●	D080 d27 Z07 3PKT 15	80	27	7	50	1,105			

TGTC ucuna uygundur. / Compatible with TGTC insert. / Kompatible für TGTC WP

WNMX 09T3

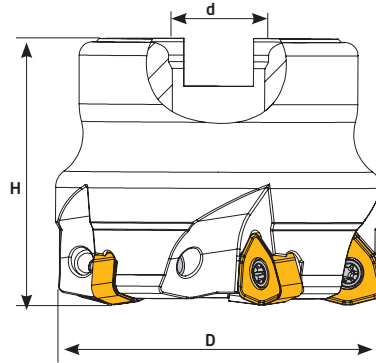

Ölçüler (mm) Dimensions(mm) Abmessungen (mm)			WNMX 09T3	
d	l	s		
9,52	6,8	3,97		

Sipariş Kodu Order Code Best.-Nr.	Stok/Stock/Lager	Ürün Kodu Product Code Produkt-Code	Ölçüler (mm) Dimensions(mm) Abmessungen (mm)					Kullanılan Uç Insert WSP	Sıkma Civatası Clamp Screw Torx-Schraube	Anahtar Torx Key Torx-Schlüssel
			D	d	Z	H				
T669	●	D040 d16 Z04 WNMX 09	40	16	4	40	0,213			
T670	●	D050 d22 Z05 WNMX 09	50	22	5	40	0,329			
T671	●	D063 d22 Z06 WNMX 09	63	22	6	40	0,542			
T671-1	●	D080 d27 Z06 WNMX 09	80	27	6	50	1,077			
T671-2	●	D100 d32 Z07 WNMX 09	100	32	7	50	1,627			

KRLY ucuna uygundur. / Compatible with KRLY insert. / Kompatible für KRLY WP

● Stokta/In Stock/Lager ○ Sınırlı Stok/Limited Stock/Begrenzte Lagerhaltung



WNMX 1305

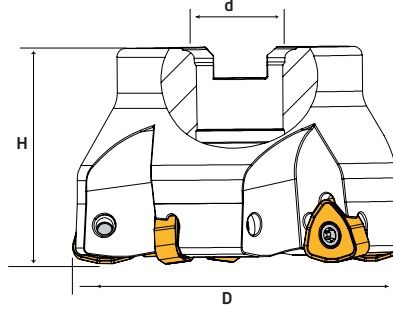

Ölçüler (mm) Dimensions(mm) Abmessungen (mm)		WNMX 1305	
d	s		
12,7	5,56		

Sipariş Kodu Order Code Best.-Nr.	Stok/Stock/Lager	Ürün Kodu Product Code Produkt-Code	Ölçüler (mm) Dimensions(mm) Abmessungen (mm)					Kullanılan Uç Insert WSP	Sıkma Cıvatası Clamp Screw Torx-Schraube	Anahtar Torx Key Torx-Schlüssel
			D	d	Z	H	KG			
T687	●	D063 d22 Z04 WNMX 13	63	22	4	50	0,752	 WNMX 1305 KRLY	 TC074 M4x10	 T15
T688	●	D080 d27 Z05 WNMX 13	80	27	5	50	1,040			
T689	●	D100 d32 Z06 WNMX 13	100	32	6	50	1,625			
T690	●	D125 d40 Z07 WNMX 13	125	40	7	63	3,716			

KRLY ucuna uygundur. / Compatible with KRLY insert. / Kompatibel für KRLY WP

100° BLMP 0603

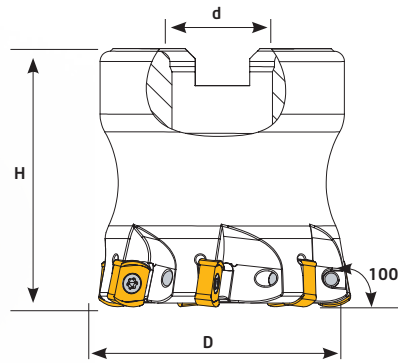

Ölçüler (mm) Dimensions(mm) Abmessungen (mm)			BLMP 0603	
d	l	s		
6,39	9	3,73		

Sipariş Kodu Order Code Best.-Nr.	Stok/Stock/Lager	Ürün Kodu Product Code Produkt-Code	Ölçüler (mm) Dimensions(mm) Abmessungen (mm)					Kullanılan Uç Insert WSP	Sıkma Cıvatası Clamp Screw Torx-Schraube	Anahtar Torx Key Torx-Schlüssel
			D	d	Z	H	KG			
T480	●	D040 d16 Z06 BLMP 06	40	16	6	45	0,262	 BLMP 0603 TGTC	 TC064 M3x6,5	 T8
T481	●	D050 d22 Z07 BLMP 06	50	22	7	50	0,457			
T482	●	D052 d22 Z07 BLMP 06	52	22	7	50	0,472			

TGTC ucuna uygundur. / Compatible with TGTC insert. / Kompatibel für TGTC WP

● Stokta/ In Stock/ Lager ○ Sınırlı Stok/ Limited Stock/ Begrenzte Lagerhaltung

Kalite için Teknik Çözüm | Technical Solution For Quality



www.teknikcuttingtools.com

100° BLMP 0904

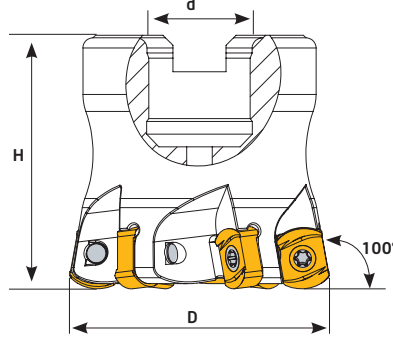

Ölçüler (mm) Dimensions(mm) Abmessungen (mm)			BLMP 0904	
d	l	S		
9,18	11,9	4,8		

Sipariş Kodu Order Code Best.-Nr.	Stok/Stock/Lager	Ürün Kodu Product Code Produkt-Code	Ölçüler (mm) Dimensions(mm) Abmessungen (mm)					Kullanılan Uç Insert WSP	Sıkma Cıvatası Clamp Screw Torx-Schraube	Anahtar Torx Key Torx-Schlüssel
			D	d	Z	H				
T485	●	D040 d16 Z05 BLMP 09	40	16	5	40	0,176	BLMP 0904 TGTC	TC069 M3,5x8,5	T10
T486	●	D052 d22 Z06 BLMP 09	52	22	6	50	0,427			
T487	●	D063 d22 Z07 BLMP 09	63	22	7	50	0,615			

TGTC ucuna uygundur. / Compatible with TGTC insert. / Kompatible für TGTC WP

LNMX 0603

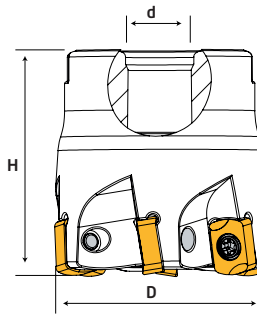

Ölçüler (mm) Dimensions(mm) Abmessungen (mm)			LNMX 0603	
L	S	A		
10	6,8	3,6		

Sipariş Kodu Order Code Best.-Nr.	Stok/Stock/Lager	Ürün Kodu Product Code Produkt-Code	Ölçüler (mm) Dimensions(mm) Abmessungen (mm)					Kullanılan Uç Insert WSP	Sıkma Cıvatası Clamp Screw Torx-Schraube	Anahtar Torx Key Torx-Schlüssel
			D	d	Z	H				
T835	●	D032 d16 Z05 LNMX 06	32	16	5	40	0,173	LNMX 0603 KRLY	TC065-1 M3x7	T8
T836	●	D040 d16 Z06 LNMX 06	40	16	6	40	0,279			
T837	●	D050 d22 Z08 LNMX 06	50	22	8	40	0,400			

KRLY ucuna uygundur. / Compatible with KRLY insert. / Kompatible für KRLY WP



100° ENMX 0604

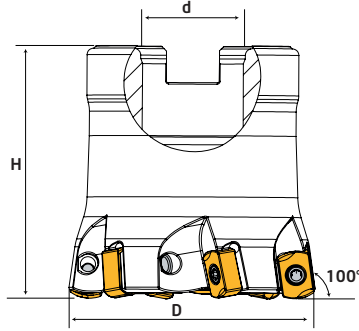

Ölçüler (mm) Dimensions(mm) Abmessungen (mm)		ENMX 0604	
d	s		
6,30	4,11		

Sipariş Kodu Order Code Best.-Nr.	Stok/Stock/Lager	Ürün Kodu Product Code Produkt-Code	Ölçüler (mm) Dimensions(mm) Abmessungen (mm)					Kullanılan Uç Insert WSP	Sıkma Civatası Clamp Screw Torx-Schraube	Anahtar Torx Key Torx-Schlüssel
			D	d	Z	H				
T763	●	D040 d16 Z06 ENMX 06	40	16	6	40	0,261	ENMX 0604 YG1	TC063 M2,5x7	T8
T764	●	D050 d22 Z06 ENMX 06	50	22	6	50	0,478			
T765	●	D063 d22 Z07 ENMX 06	63	22	7	50	0,762			

YG1 ucuna uygundur. / Compatible with YG1 insert. / Kompatible für YG1 WP

100° ENMX 0905

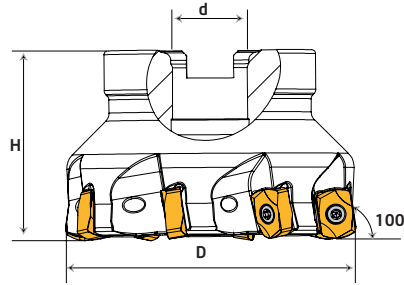

Ölçüler (mm) Dimensions(mm) Abmessungen (mm)		ENMX 0905	
d	s		
9	5,4		

Sipariş Kodu Order Code Best.-Nr.	Stok/Stock/Lager	Ürün Kodu Product Code Produkt-Code	Ölçüler (mm) Dimensions(mm) Abmessungen (mm)					Kullanılan Uç Insert WSP	Sıkma Civatası Clamp Screw Torx-Schraube	Anahtar Torx Key Torx-Schlüssel
			D	d	Z	H				
T701	●	D050 d22 Z04 ENMX 09	50	22	4	50	0,487	ENMX 0905 YG1	TC069 M3,5x8,5	T10
T702	●	D063 d22 Z05 ENMX 09	63	22	5	50	0,796			
T703	●	D080 d27 Z08 ENMX 09	80	27	8	50	1,188			
T704	●	D100 d32 Z10 ENMX 09	100	32	10	63	2,867			
T705	●	D125 d40 Z12 ENMX 09	125	40	12	63	4,186			

YG1 ucuna uygundur. / Compatible with YG1 insert. / Kompatible für YG1 WP

● Stokta/In Stock/Lager ○ Sınırlı Stok/Limited Stock/Begrenzte Lagerhaltung

Kalite için Teknik Çözüm | Technical Solution For Quality

BROTECH

TEKNİK
Cutting Tools

www.teknikcuttingtools.com

LNMU 0303

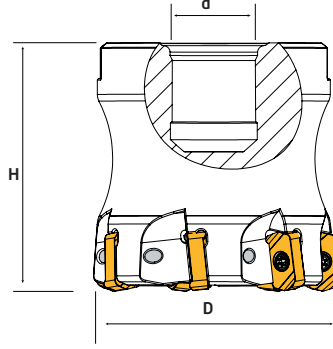

Ölçüler (mm) Dimensions(mm) Abmessungen (mm)			LNMU 0303	
L	S	A		
11.8	4.1	6		

Sipariş Kodu Order Code Best.-Nr.	Stok/Stock/Lager	Ürün Kodu Product Code Produkt-Code	Ölçüler (mm) Dimensions(mm) Abmessungen (mm)					Kullanılan Uç Insert WSP	Sıkma Cıvatası Clamp Screw Torx-Schraube	Anahtar Torx Key Torx-Schlüssel
			D	d	Z	H	kg			
T728	●	D040 d16 Z06 LNMU 03	40	16	6	40	0,275			
T729	●	D050 d22 Z07 LNMU 03	50	22	7	50	0,541			
T730	●	D063 d22 Z09 LNMU 03	63	22	9	50	0,766			

TGNLY - OKE ucuna uygundur. / Compatible with TGNLY - OKE insert. / Kompatible für TGNLY - OKE WP

LOGU 0303

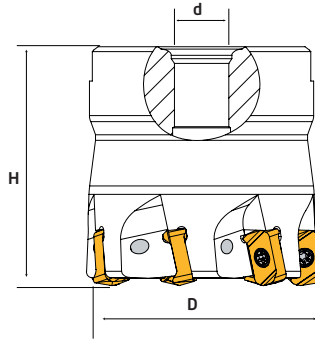

Ölçüler (mm) Dimensions(mm) Abmessungen (mm)			LOGU 0303	
L	S	A		
11.8	4.9	6.2		

Sipariş Kodu Order Code Best.-Nr.	Stok/Stock/Lager	Ürün Kodu Product Code Produkt-Code	Ölçüler (mm) Dimensions(mm) Abmessungen (mm)					Kullanılan Uç Insert WSP	Sıkma Cıvatası Clamp Screw Torx-Schraube	Anahtar Torx Key Torx-Schlüssel
			D	d	Z	H	kg			
T731	●	D040 d16 Z06 LOGU 03	40	16	6	40	0,283			
T732	●	D050 d22 Z07 LOGU 03	50	22	7	50	0,582			
T734	●	D063 d22 Z09 LOGU 03	63	22	9	50	1,188			

KYCR ucuna uygundur. / Compatible with KYCR insert. / Kompatible für KYCR WP

● Stokta/In Stock/Lager ○ Sınırlı Stok/Limited Stock/Begrenzte Lagerhaltung



SDMT 09T3

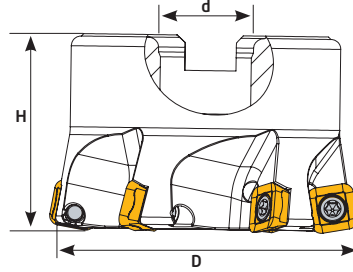

Ölçüler (mm) Dimensions(mm) Abmessungen (mm)		SDMT 09T3	
L	S	15°	
9,52	3,97	15°	

Sipariş Kodu Order Code Best.-Nr.	Stok/Stock/Lager	Ürün Kodu Product Code Produkt-Code	Ölçüler (mm) Dimensions(mm) Abmessungen (mm)					Kullanılan Uç Insert WSP	Sıkma Civatası Clamp Screw Torx-Schraube	Anahtar Torx Key Torx-Schlüssel
			D	d	Z	H	KG			
T362	●	D040 d16 Z04 SDMT 09	40	16	4	40	0,215	SDMT 09T3 ZCC	TC067 M3,5x8,5	T15
T363	●	D050 d22 Z05 SDMT 09	50	22	5	40	0,355			
T364	●	D063 d22 Z06 SDMT 09	63	22	6	40	0,592			

ZCC ucuna uygundur. / Compatible with ZCC insert. / Kompatible für ZCC WP

SDMT 1204

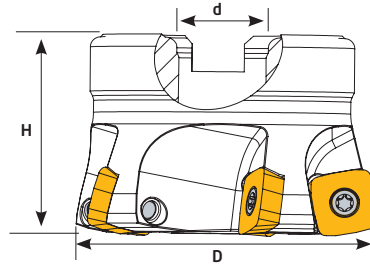

Ölçüler (mm) Dimensions(mm) Abmessungen (mm)		SDMT 1204	
L	S	15°	
12,7	4,76	15°	

Sipariş Kodu Order Code Best.-Nr.	Stok/Stock/Lager	Ürün Kodu Product Code Produkt-Code	Ölçüler (mm) Dimensions(mm) Abmessungen (mm)					Kullanılan Uç Insert WSP	Sıkma Civatası Clamp Screw Torx-Schraube	Anahtar Torx Key Torx-Schlüssel
			D	d	Z	H	KG			
T358	●	D050 d22 Z04 SDMT 12	50	22	4	40	0,315	SDMT 1204 ZCC	TC074 M4x10	T15
T359	●	D063 d22 Z05 SDMT 12	63	22	5	40	0,422			
T360	●	D080 d27 Z06 SDMT 12	80	27	6	52	1,051			

ZCC ucuna uygundur. / Compatible with ZCC insert. / Kompatible für ZCC WP

● Stokta/ In Stock/ Lager ○ Sınırlı Stok/ Limited Stock/ Begrenzte Lagerhaltung

Kalite için Teknik Çözüm | Technical Solution For Quality

ZDEW 1204

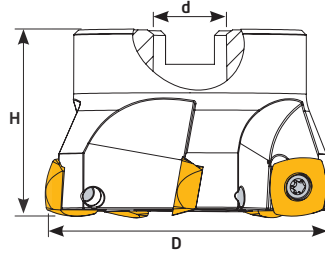
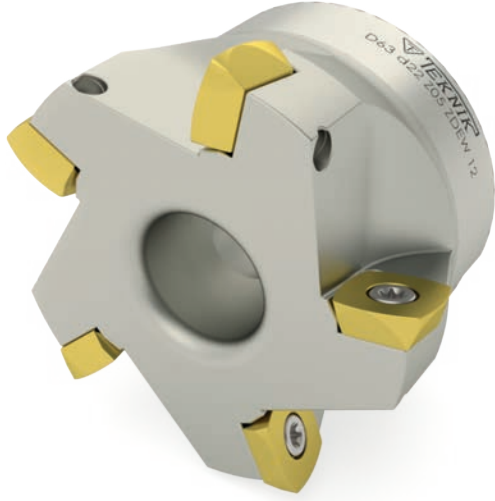

Ölçüler (mm) Dimensions(mm) Abmessungen (mm)			ZDEW 1204	
l	s	d		
12,7	4,76	12,7		

Sipariş Kodu Order Code Best.-Nr.	Stok/Stock/Lager	Ürün Kodu Product Code Produkt-Code	Ölçüler (mm) Dimensions(mm) Abmessungen (mm)					Kullanılan Uç Insert WSP	Sıkma Civatası Clamp Screw Torx-Schraube	Anahtar Torx Key Torx-Schlüssel
			D	d	Z	H				
T196	●	D050 d22 Z04 ZDEW 12	50	22	4	40	0,256	ZDEW 1204 PRMT	TC080-1 M4,5x11	T15
T197	●	D063 d22 Z05 ZDEW 12	63	22	5	40	0,474			

PRMT ucuna uygundur. / Compatible with PRMT insert. / Kompatible für PRMT WP

RNHX 1204

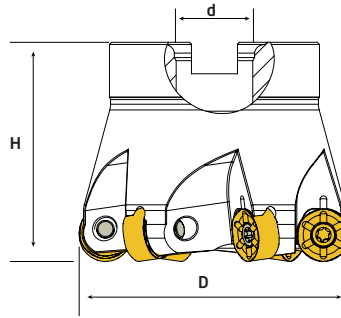

Ölçüler (mm) Dimensions(mm) Abmessungen (mm)		RNHX 1204	
d	s		
12	4,76		

Sipariş Kodu Order Code Best.-Nr.	Stok/Stock/Lager	Ürün Kodu Product Code Produkt-Code	Ölçüler (mm) Dimensions(mm) Abmessungen (mm)					Kullanılan Uç Insert WSP	Sıkma Civatası Clamp Screw Torx-Schraube	Anahtar Torx Key Torx-Schlüssel
			D	d	Z	H				
T661	●	D050 d22 Z05 RNHX 12	50	22	5	40	0,284	RNHX 1204 PLBT	TC074 M4x10	T15
T662	●	D063 d22 Z06 RNHX 12	63	22	6	50	0,637			
T664	●	D100 d32 Z08 RNHX 12	100	32	8	50	1,570			



PLBT ucuna uygundur. / Compatible with PLBT insert. / Kompatible für PLBT WP

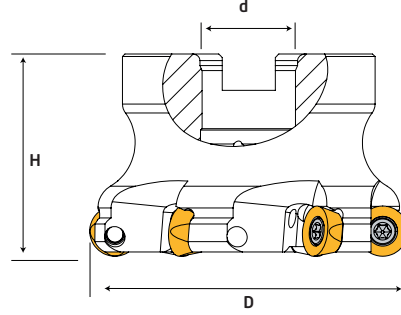

RPMW 10T3

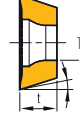
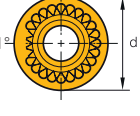

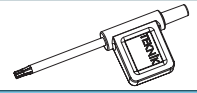

Ölçüler (mm) Dimensions(mm) Abmessungen (mm)		RPMW 10T3	
t	d		
3,97	10		

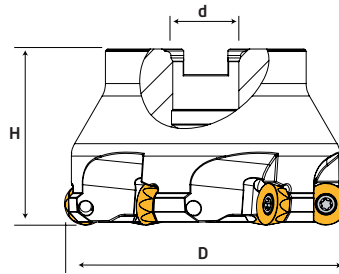

Sipariş Kodu Order Code Best.-Nr.	Stok/Stock/Lager	Ürün Kodu Product Code Produkt-Code	Ölçüler (mm) Dimensions(mm) Abmessungen (mm)					Kullanılan Uç Insert WSP	Sıkma Cıvatası Clamp Screw Torx-Schraube	Anahtar Torx Key Torx-Schlüssel
			D	d	Z	H				
T706	●	D040 d16 Z05 RPMW 10	40	16	5	40	0,240			
T707	●	D050 d22 Z06 RPMW 10	50	22	6	40	0,359			
T708	●	D063 d22 Z06 RPMW 10	63	22	6	40	0,584			
T709	●	D080 d27 Z07 RPMW 10	80	27	7	50	1,272			
								RPMW10T3 KRLY	TC067 M3,5x8,5	T15

KRLY ucuna uygundur. / Compatible with KRLY insert. / Kompatible für KRLY WP

RPMW 1204

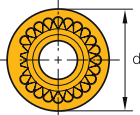

Ölçüler (mm) Dimensions(mm) Abmessungen (mm)		RPMW 1204	
t	d		
4,76	12		

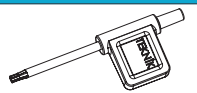
Sipariş Kodu Order Code Best.-Nr.	Stok/Stock/Lager	Ürün Kodu Product Code Produkt-Code	Ölçüler (mm) Dimensions(mm) Abmessungen (mm)					Kullanılan Uç Insert WSP	Sıkma Cıvatası Clamp Screw Torx-Schraube	Anahtar Torx Key Torx-Schlüssel
			D	d	Z	H				
T711	●	D050 d22 Z05 RPMW 12	50	22	5	40	0,327			
T712	●	D063 d22 Z05 RPMW 12	63	22	5	40	0,556			
T713	●	D080 d27 Z06 RPMW 12	80	27	6	50	0,584			
T714	●	D100 d32 Z07 RPMW 12	100	32	7	53	1,278			
								RPMW1204 KRLY	TC073 M4x7	T15

KRLY ucuna uygundur. / Compatible with KRLY insert. / Kompatible für KRLY WP

● Stokta/In Stock/Lager ○ Sınırlı Stok/Limited Stock/Begrenzte Lagerhaltung

Kalite için Teknik Çözüm | Technical Solution For Quality



www.teknikcuttingtools.com

RPMW 1606

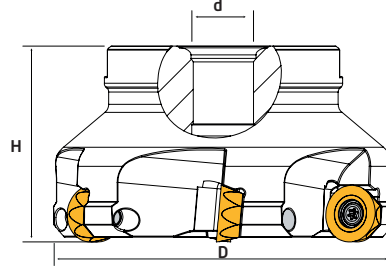

Ölçüler (mm) Dimensions(mm) Abmessungen (mm)		RPMW 1606	
t	d		
6,35	16		

Sipariş Kodu Order Code Best.-Nr.	Stok/Stock/Lager	Ürün Kodu Product Code Produkt-Code	Ölçüler (mm) Dimensions(mm) Abmessungen (mm)					Kullanılan Uç Insert WSP	Sıkma Cıvatası Clamp Screw Torx-Schraube	Anahtar Torx Key Torx-Schlüssel
			D	d	Z	H				
T717	●	D063 d22 Z05 RPMW 16	63	22	5	40	0,509	RPMW 1606 KRLY	TC083 M5X12	T20
T718	●	D080 d27 Z06 RPMW 16	80	27	6	50	1,048			
T719	●	D100 d32 Z07 RPMW 16	100	32	7	55	0,584			
T720	●	D125 d40 Z08 RPMW 16	125	40	8	63	1,903			

KRLY ucuna uygundur. / Compatible with KRLY insert. / Kompatibel für KRLY WP

RDMT 1003

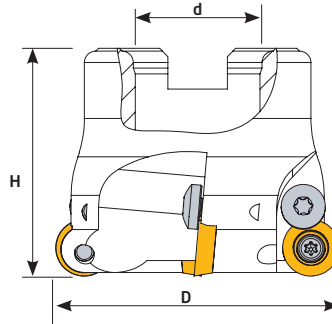

Ölçüler (mm) Dimensions(mm) Abmessungen (mm)		RDMT 1003	
d	S		
10	3,18		



Sipariş Kodu Order Code Best.-Nr.	Stok/Stock/Lager	Ürün Kodu Product Code Produkt-Code	Ölçüler (mm) Dimensions(mm) Abmessungen (mm)					Kullanılan Uç Insert WSP	Baskı Cıvatası Locking Screw Verriegelungs Schraube	Sıkma Cıvatası Clamp Screw Torx-Schraube	Anahtar Torx Key Torx-Schlüssel
			D	d	Z	H					
T288	●	D040 d16 Z03 RDMT 10	40	16	3	40	0,208	RDMT 1003 ISO	TC040 M3,5	TC067 M3,5x8,5	T15
T289	●	D040 d16 Z04 RDMT 10	40	16	4	40	0,220				
T290	●	D050 d22 Z04 RDMT 10	50	22	4	40	0,310				
T291	●	D050 d22 Z05 RDMT 10	50	22	5	40	0,302				
T292	●	D063 d22 Z05 RDMT 10	63	22	5	40	0,445				
T293	●	D063 d22 Z06 RDMT 10	63	22	6	40	0,460				
T294	●	D080 d27 Z06 RDMT 10	80	27	6	50	1,033				
T294-1	●	D080 d27 Z07 RDMT 10	80	27	7	50	1,048				
T295	●	D100 d32 Z07 RDMT 10	100	32	7	50	1,463				
T295-1	●	D100 d32 Z08 RDMT 10	100	32	8	50	1,478				

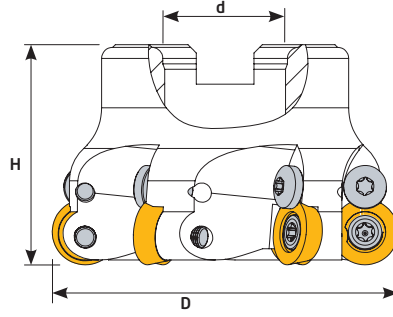
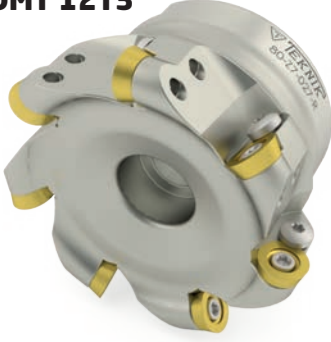

RDMT 12T3

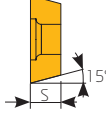
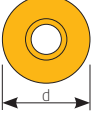



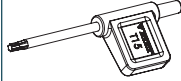

Ölçüler (mm) Dimensions(mm) Abmessungen (mm)		RDMT 12T3	
d	s		
12	3,97		

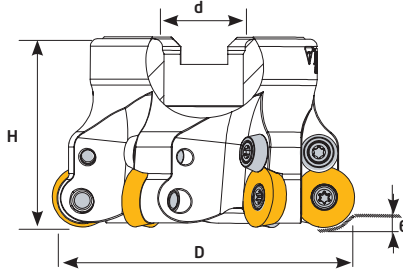
Sipariş Kodu Order Code Best.-Nr.	Stok/Stock/Lager	Ürün Kodu Product Code Produkt-Code	Ölçüler (mm) Dimensions(mm) Abmessungen (mm)					Kullanılan Uç Insert WSP	Baskı Cıvatası Locking Screw Verriegelungs Schraube	Sıkma Cıvatası Clamp Screw Torx-Schraube	Anahtar Torx Key Torx-Schlüssel
			D	d	Z	H					
T280	●	D040 d16 Z03 RDMT 12	40	16	3	40	0,235				
T281	●	D040 d16 Z04 RDMT 12	40	16	4	40	0,236				
T282	●	D050 d22 Z04 RDMT 12	50	22	4	40	0,311				
T283	●	D050 d22 Z05 RDMT 12	50	22	5	40	0,309				
T284	●	D063 d22 Z05 RDMT 12	63	22	5	40	0,468				
T285	●	D063 d22 Z06 RDMT 12	63	22	6	40	0,500				
T286	●	D080 d27 Z06 RDMT 12	80	27	6	50	0,925				
T286-1	●	D080 d27 Z07 RDMT 12	80	27	7	50	0,950				
T287	●	D100 d32 Z07 RDMT 12	100	32	7	50	1,402				
T287-1	●	D100 d32 Z08 RDMT 12	100	32	8	50	1,435				

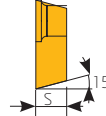
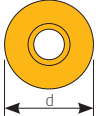
RDMT 1604



Ölçüler (mm) Dimensions(mm) Abmessungen (mm)		RDMT 1604	
d	s		
16	4,76		

Sipariş Kodu Order Code Best.-Nr.	Stok/Stock/Lager	Ürün Kodu Product Code Produkt-Code	Ölçüler (mm) Dimensions(mm) Abmessungen (mm)					Kullanılan Uç Insert WSP	Baskı Keki Clamp Spann- pratze	Baskı Cıvatası Clamp Screw Torx-Schraube	Sıkma Cıvatası Locking Screw Verriegelungs Schraube	Anahtar Torx Key Torx-Schlüssel
			D	d	Z	H						
T270	●	D050 d22 Z04 RDMT 16	50	22	4	50	0,350					
T271	●	D052 d22 Z04 RDMT 16	52	22	4	50	0,350					
T273	●	D063 d22 Z05 RDMT 16	63	22	5	45	0,512					
T272	●	D066 d27 Z05 RDMT 16	66	27	5	50	0,495					
T274	●	D080 d27 Z06 RDMT 16	80	27	6	50	0,890					
T275	●	D100 d32 Z07 RDMT 16	100	32	7	52	1,370					

● Stokta/ In Stock/ Lager ○ Sınırlı Stok/ Limited Stock/ Begrenzte Lagerhaltung

Kalite için Teknik Çözüm | Technical Solution For Quality



www.teknikcuttingtools.com

RDMT 12T3

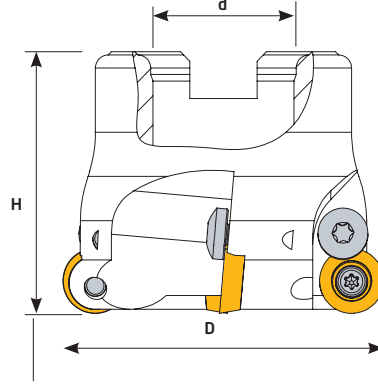

Ölçüler (mm) Dimensions(mm) Abmessungen (mm)		RDMT 12T3	
d	s		
12	3,97		

Sipariş Kodu Order Code Best.-Nr.	Stok/Stock/Lager	Ürün Kodu Product Code Produkt-Code	Ölçüler (mm) Dimensions(mm) Abmessungen (mm)					Kullanılan Uç Insert WSP	Baskı Cıvatası Locking Screw Verriegelungs Schraube	Sıkma Cıvatası Clamp Screw Torx-Schraube	Anahtar Torx Key Torx-Schlüssel
			D	d	Z	H	kg				
T667	○	D052 d22 Z05 RDMT 12	52	22	5	50	0,403	RDMT 12T3 PLBT	TC040 M3,5	TC067 M3,5x8,5	T15
T668-1	○	D066 d27 Z06 RDMT 12	66	27	6	50	0,670				
T668	○	D080 d27 Z07 RDMT 12	80	27	7	50	1,181				

PLBT ucuna uygundur. / Compatible with PLBT insert. / Kompatible für PLBT WP

RCKT 1204

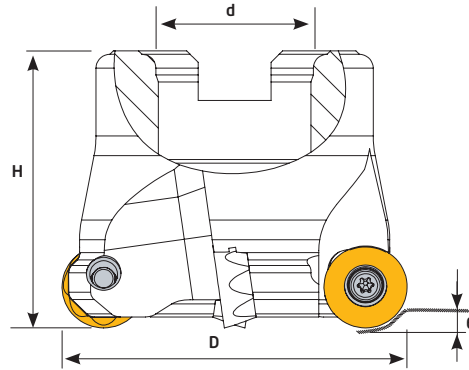

Ölçüler (mm) Dimensions(mm) Abmessungen (mm)		RCKT 1204	
L	s		
12	4,76		

Sipariş Kodu Order Code Best.-Nr.	Stok/Stock/Lager	Ürün Kodu Product Code Produkt-Code	Ölçüler (mm) Dimensions(mm) Abmessungen (mm)					Kullanılan Uç Insert WSP	Sıkma Cıvatası Clamp Screw Torx-Schraube	Anahtar Torx Key Torx-Schlüssel
			D	d	Z	H	kg			
T460	●	D050 d22 Z04 RCKT 12	50	22	4	40	0,287	RCKT 1204 SNDVK	TC067 M3,5x8,5	T15
T462	●	D063 d22 Z05 RCKT 12	63	22	5	40	0,436			
T464	●	D080 d27 Z06 RCKT 12	80	27	6	50	1,088			
T466	●	D100 d32 Z07 RCKT 12	100	32	7	52	1,608			

SNDVK ucuna uygundur. / Compatible with SNDVK insert. / Kompatible für SNDVK WP



RHKW 0802

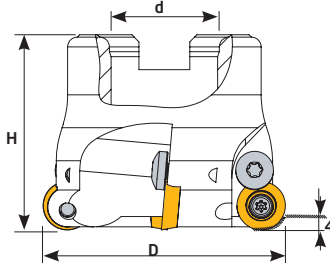

Ölçüler (mm) Dimensions(mm) Abmessungen (mm)		RHKW 0802	
d	S		
8	2,6		

Sipariş Kodu Order Code Best.-Nr.	Stok/Stock/Lager	Ürün Kodu Product Code Produkt-Code	Ölçüler (mm) Dimensions(mm) Abmessungen (mm)						Kullanılan Uç Insert WSP	Baskı Cıvatası Locking Screw Verriegelungs Schraube	Sıkma Cıvatası Clamp Screw Torx-Schraube	Anahtar Torx Key Torx-Schlüssel
			D	d	Z	H	kg					
T599	○	D040 d16 Z04 RHKW 08	40	16	4	40	0,247	RHKW 0802 INGRSL				
T600	○	D050 d22 Z05 RHKW 08	50	22	5	40	0,309					
T601	○	D063 d22 Z06 RHKW 08	63	22	6	40	0,530					

INGRSL ucuna uygundur. / Compatible with INGRSL insert. / Kompatible für INGRSL WP

RHKW 1003

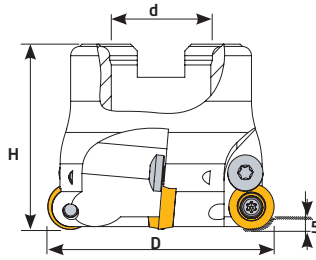

Ölçüler (mm) Dimensions(mm) Abmessungen (mm)		RHKW 1003	
d	S		
10	3,8		

Sipariş Kodu Order Code Best.-Nr.	Stok/Stock/Lager	Ürün Kodu Product Code Produkt-Code	Ölçüler (mm) Dimensions(mm) Abmessungen (mm)						Kullanılan Uç Insert WSP	Baskı Cıvatası Locking Screw Verriegelungs Schraube	Sıkma Cıvatası Clamp Screw Torx-Schraube	Anahtar Torx Key Torx-Schlüssel
			D	d	Z	H	kg					
T602	○	D040 d16 Z04 RHKW 10	40	16	4	40	0,243	RHKW 1003 INGRSL				
T604	○	D050 d22 Z05 RHKW 10	50	22	5	40	0,289					
T606	○	D063 d22 Z06 RHKW 10	63	22	6	40	0,488					
T608	○	D080 d27 Z07 RHKW 10	80	27	7	50	1,080					

INGRSL ucuna uygundur. / Compatible with INGRSL insert. / Kompatible für INGRSL WP

RHKW 1204

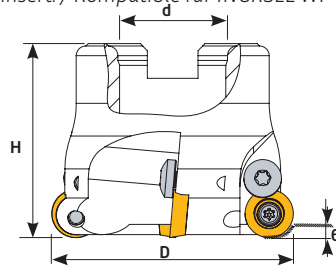

Ölçüler (mm) Dimensions(mm) Abmessungen (mm)		RHKW 1204	
d	s		
12	4,76		

Sipariş Kodu Order Code Best.-Nr.	Stok/Stock/Lager	Ürün Kodu Product Code Produkt-Code	Ölçüler (mm) Dimensions(mm) Abmessungen (mm)						Kullanılan Uç Insert WSP	Baskı Cıvatası Locking Screw Verriegelungs Schraube	Sıkma Cıvatası Clamp Screw Torx-Schraube	Anahtar Torx Key Torx-Schlüssel
			D	d	Z	H	kg					
T612	○	D040 d16 Z04 RHKW 12	40	16	4	40	0,246	RHKW 1204 INGRSL				
T613	○	D050 d22 Z05 RHKW 12	50	22	5	40	0,304					
T614	○	D063 d22 Z06 RHKW 12	63	22	6	45	0,556					
T615	○	D080 d27 Z07 RHKW 12	80	27	7	50	1,039					

INGRSL ucuna uygundur. / Compatible with INGRSL insert. / Kompatible für INGRSL WP

● Stokta/In Stock/Lager ○ Sınırlı Stok/Limited Stock/Begrenzte Lagerhaltung

Kalite için Teknik Çözüm | Technical Solution For Quality



www.teknikcuttingtools.com

90° APMT 0602

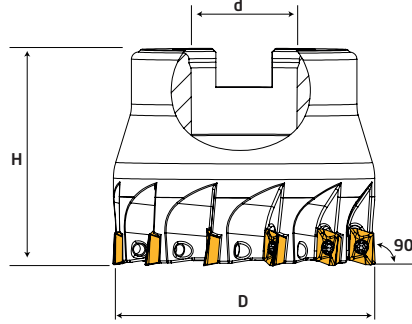

Ölçüler (mm) Dimensions(mm) Abmessungen (mm)		APMT 0602	
L	s		
6	2,6		

Sipariş Kodu Order Code Best.-Nr.	Stok/Stock/Lager	Ürün Kodu Product Code Produkt-Code	Ölçüler (mm) Dimensions(mm) Abmessungen (mm)					Kullanılan Uç Insert WSP	Sıkma Civatası Clamp Screw Torx-Schraube	Anahtar Torx Key Torx-Schlüssel
			D	d	Z	H	Ⓢ			
T596	●	D40 d16 Z10 APMT 06	40	16	10	40	0,281	APMT 0602 KRLY	TC057-1 M1,8x4,1	T6
T597	●	D50 d22 Z12 APMT 06	50	22	12	40	0,435			
T598	●	D63 d22 Z14 APMT 06	63	22	14	40	0,715			

KRLY ucuna uygundur. / Compatible with KRLY insert. / Kompatibel für KRLY WP

90° APMT 11T3

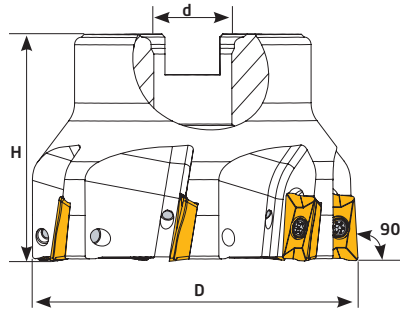

Ölçüler (mm) Dimensions(mm) Abmessungen (mm)		APMT 11T3	
L	S		
11	3,97		

Sipariş Kodu Order Code Best.-Nr.	Stok/Stock/Lager	Ürün Kodu Product Code Produkt-Code	Ölçüler (mm) Dimensions(mm) Abmessungen (mm)					Kullanılan Uç Insert WSP	Sıkma Civatası Clamp Screw Torx-Schraube	Anahtar Torx Key Torx-Schlüssel
			D	d	Z	H	Ⓢ			
T250	●	D040 d16 Z05 APMT 11	40	16	5	40	0,220	APMT 11T3 KRLY	TC060 M2,5x5,5	T8
T252	●	D050 d22 Z06 APMT 11	50	22	6	40	0,332			
T254	●	D063 d22 Z07 APMT 11	63	22	7	40	0,483			
T256	●	D080 d27 Z08 APMT 11	80	27	8	50	1,115			
T258	●	D100 d32 Z10 APMT 11	100	32	10	63	1,810			

KRLY ucuna uygundur. / Compatible with KRLY insert. / Kompatibel für KRLY WP

● Stokta/In Stock/Lager ○ Sınırlı Stok/Limited Stock/Begrenzte Lagerhaltung



90° APMT 1604

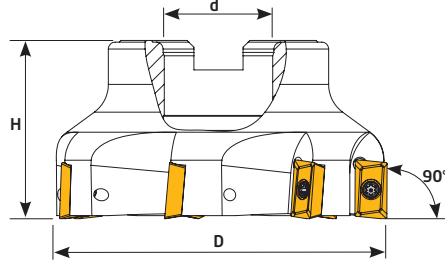

Ölçüler (mm) Dimensions(mm) Abmessungen (mm)		APMT 1604	
L	S		
16,4	4,76		

Sipariş Kodu Order Code Best.-Nr.	Stok/Stock/Lager	Ürün Kodu Product Code Produkt-Code	Ölçüler (mm) Dimensions(mm) Abmessungen (mm)					Kullanılan Uç Insert WSP	Sıkma Civatası Clamp Screw Torx-Schraube	Anahtar Torx Key Torx-Schlüssel
			D	d	Z	H	kg			
T241	●	D040 d16 Z04 APMT 16	40	16	4	45	0,258	APMT 1604 KRLY	TC074 M4x10	T15
T243	●	D050 d22 Z05 APMT 16	50	22	5	45	0,400			
T245	●	D063 d22 Z06 APMT 16	63	22	6	45	0,578			
T247	●	D080 d27 Z07 APMT 16	80	27	7	52	1,249			
T249	●	D100 d32 Z08 APMT 16	100	32	8	52	1,530			

KRLY ucuna uygundur. / Compatible with KRLY insert. / Kompatible fr KRLY WP

90° APKT 1604

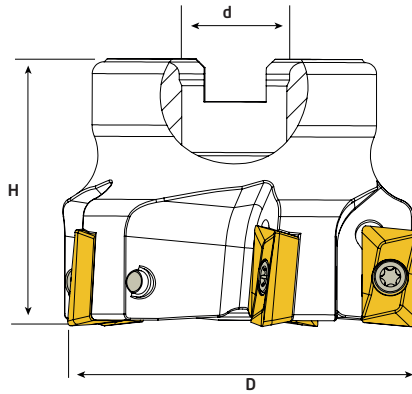

Ölçüler (mm) Dimensions(mm) Abmessungen (mm)		APKT 1604	
L	S		
16,39	5,82		

Sipariş Kodu Order Code Best.-Nr.	Stok/Stock/Lager	Ürün Kodu Product Code Produkt-Code	Ölçüler (mm) Dimensions(mm) Abmessungen (mm)					Kullanılan Uç Insert WSP	Sıkma Civatası Clamp Screw Torx-Schraube	Anahtar Torx Key Torx-Schlüssel
			D	d	Z	H	kg			
T767	●	D050 d22 Z04 APKT 16	50	22	4	45	0,381	APKT 1604 YG1	TC074 M4x10	T15
T768	●	D063 d22 Z05 APKT 16	63	22	5	45	0,507			
T769	●	D080 d27 Z06 APKT 16	80	27	6	52	1,125			

YG1 ucuna uygundur. / Compatible with YG1 insert. / Kompatible für YG1 WP

● Stokta/ In Stock/ Lager ○ Sınırlı Stok/ Limited Stock/ Begrenzte Lagerhaltung

Kalite için Teknik Çözüm | Technical Solution For Quality

BROTECH

TEKNİK
Cutting Tools

www.teknikcuttingtools.com

39

90° APXT 1003

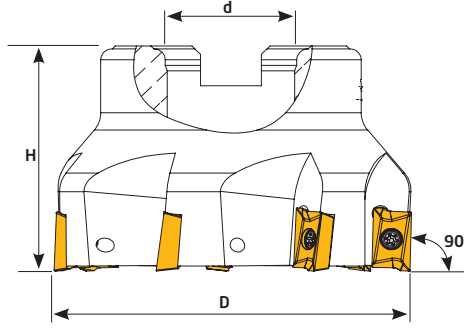

Ölçüler (mm) Dimensions(mm) Abmessungen (mm)		APXT 1003	
L	s		
10,5	3,52		

Sipariş Kodu Order Code Best.-Nr.	Stok/Stock/Lager	Ürün Kodu Product Code Produkt-Code	Ölçüler (mm) Dimensions(mm) Abmessungen (mm)					Kullanılan Uç Insert WSP	Sıkma Civatası Clamp Screw Torx-Schraube	Anahtar Torx Key Torx-Schlüssel
			D	d	Z	H				
T176	●	D040 d16 Z05 APXT 10	40	16	5	40	0,277	APXT1003 KRLY	TC060 M2,5x5,5	T8
T177	●	D050 d22 Z06 APXT 10	50	22	6	40	0,398			
T178	●	D063 d22 Z07 APXT 10	63	22	7	40	0,543			
T179	●	D080 d27 Z08 APXT 10	80	27	8	50	1,205			

KRLY ucuna uygundur. / Compatible with KRLY insert. / Kompatible für KRLY WP

90° APKT 1604

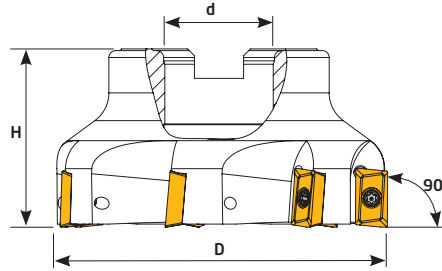

Ölçüler (mm) Dimensions(mm) Abmessungen (mm)		APKT 1604	
L	s		
16,4	4,76		

Sipariş Kodu Order Code Best.-Nr.	Stok/Stock/Lager	Ürün Kodu Product Code Produkt-Code	Ölçüler (mm) Dimensions(mm) Abmessungen (mm)					Kullanılan Uç Insert WSP	Sıkma Civatası Clamp Screw Torx-Schraube	Anahtar Torx Key Torx-Schlüssel
			D	d	Z	H				
T180	●	D040 d16 Z03 APKT 16	40	16	3	45	0,267	APKT1604 KRLY	TC074 M4x10	T15
T181	●	D040 d16 Z04 APKT 16	40	16	4	45	0,258			
T182	●	D050 d22 Z04 APKT 16	50	22	4	45	0,406			
T183	●	D050 d22 Z05 APKT 16	50	22	5	45	0,400			
T184	●	D063 d22 Z05 APKT 16	63	22	5	45	0,577			
T185	●	D063 d22 Z06 APKT 16	63	22	6	45	0,578			
T186	●	D080 d27 Z06 APKT 16	80	27	6	52	1,159			
T187	●	D080 d27 Z07 APKT 16	80	27	7	52	1,249			
T188	●	D100 d32 Z07 APKT 16	100	32	7	52	1,057			
T189	●	D100 d32 Z08 APKT 16	100	32	8	52	1,530			
T190	●	D125 d40 Z09 APKT 16	125	40	9	62	3,642			
T192	●	D160 d40 Z10 APKT 16	160	40	10	62	4,885			
T193	●	D200 d60 Z12 APKT 16	200	60	12	63	6,370			
T195	●	D300 d60 Z15 APKT 16	300	60	15	62	14,360			

KRLY ucuna uygundur. / Compatible with KRLY insert. / Kompatible für KRLY WP

● Stokta/In Stock/Lager ○ Sınırlı Stok/Limited Stock/Begrenzte Lagerhaltung



90° XOMX 1204

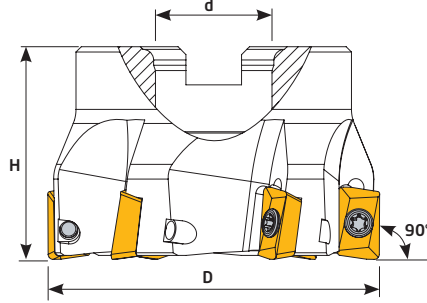

Ölçüler (mm) Dimensions(mm) Abmessungen (mm)		XOMX 1204	
L	s	L	
12,16	5,06	L	

Sipariş Kodu Order Code Best.-Nr.	Stok / Stock / Lager	Ürün Kodu Product Code Produkt-Code	Ölçüler (mm) Dimensions(mm) Abmessungen (mm)					Kullanılan Uç Insert WSP	Sıkma Cıvatası Clamp Screw Torx-Schraube	Anahtar Torx Key Torx-Schlüssel
			D	d	Z	H	kg			
T510	●	D040 d16 Z04 XOMX 12	40	16	4	40	0,250	XOMX 1204 SCO	TC069 M3,5x8,5	T10
T512	●	D050 d22 Z05 XOMX 12	50	22	5	40	0,351			
T514	●	D063 d22 Z06 XOMX 12	63	22	6	40	0,618			
T516	●	D080 d27 Z07 XOMX 12	80	27	7	50	1,155			
T518	●	D100 d32 Z10 XOMX 12	100	32	10	52	1,817			
T519	●	D125 d40 Z12 XOMX 12	125	40	12	62	3,565			

SCO ucuna uygundur. / Compatible with SCO insert. / Kompatible für SCO WP

90° XOMX 1806

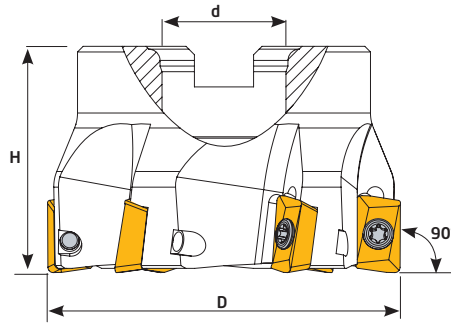

Ölçüler (mm) Dimensions(mm) Abmessungen (mm)		XOMX 1806	
L	s	L	
17,5	6,35	L	

Sipariş Kodu Order Code Best.-Nr.	Stok / Stock / Lager	Ürün Kodu Product Code Produkt-Code	Ölçüler (mm) Dimensions(mm) Abmessungen (mm)					Kullanılan Uç Insert WSP	Sıkma Cıvatası Clamp Screw Torx-Schraube	Anahtar Torx Key Torx-Schlüssel
			D	d	Z	H	kg			
T520	●	D050 d22 Z05 XOMX 18	50	22	5	45	0,337	XOMX 1806 SCO	TC080 M4,5x11	T15
T522	●	D063 d22 Z06 XOMX 18	63	22	6	45	0,550			
T524	●	D080 d27 Z07 XOMX 18	80	27	7	50	1,082			
T525	●	D100 d32 Z08 XOMX 18	100	32	8	52	1,661			
T526	●	D125 d40 Z09 XOMX 18	125	40	9	62	3,427			
T527	●	D160 d40 Z10 XOMX 18	160	40	10	62	4,831			

SCO ucuna uygundur. / Compatible with SCO insert. / Kompatible für SCO WP

● Stokta / In Stock / Lager ○ Sınırlı Stok / Limited Stock / Begrenzte Lagerhaltung

Kalite için Teknik Çözüm | Technical Solution For Quality



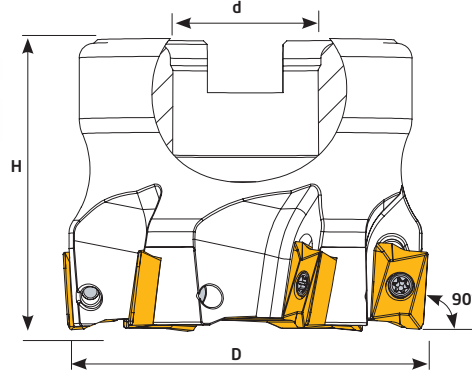

www.teknikcuttingtools.com

90° R390-11T3

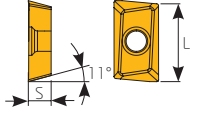

Ölçüler (mm) Dimensions(mm) Abmessungen (mm)		R390-11T3	
L	S		
11	3,18		

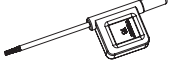

Sipariş Kodu Order Code Best.-Nr.	Stok/Stock/Lager	Ürün Kodu Product Code Produkt-Code	Ölçüler (mm) Dimensions(mm) Abmessungen (mm)					Kullanılan Uç Insert WSP	Sıkma Civatası Clamp Screw Torx-Schraube	Anahtar Torx Key Torx-Schlüssel
			D	d	Z	H	kg			
T577	●	D040 d16 Z05 R390 11	40	16	5	40	0,225			
T578	●	D050 d22 Z06 R390 11	50	22	6	40	0,355			
T579	●	D063 d22 Z07 R390 11	63	22	7	40	0,503			

SNDVK ucuna uygundur. / Compatible with SNDVK insert. / Kompatible für SNDVK WP

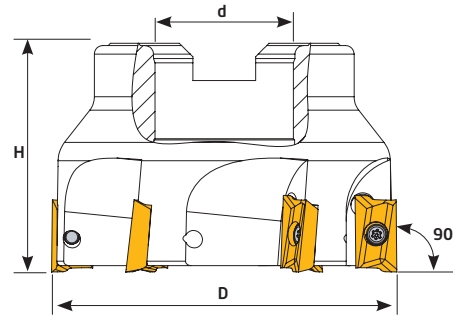
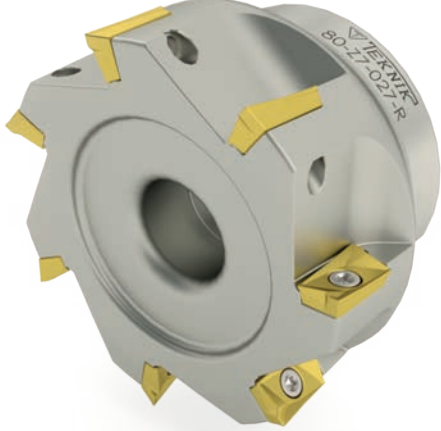
90° R390-1704

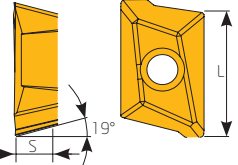

Ölçüler (mm) Dimensions(mm) Abmessungen (mm)		R390-1704	
L	S		
17	4,76		

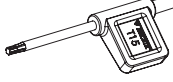
Sipariş Kodu Order Code Best.-Nr.	Stok/Stock/Lager	Ürün Kodu Product Code Produkt-Code	Ölçüler (mm) Dimensions(mm) Abmessungen (mm)					Kullanılan Uç Insert WSP	Sıkma Civatası Clamp Screw Torx-Schraube	Anahtar Torx Key Torx-Schlüssel
			D	d	Z	H	kg			
T402	●	D040 d16 Z04 R390 17	40	16	4	45	0,276			
T404	●	D050 d22 Z05 R390 17	50	22	5	45	0,591			
T408	●	D063 d22 Z06 R390 17	63	22	6	45	0,590			
T411	●	D080 d27 Z07 R390 17	80	27	7	52	1,168			
T412	●	D100 d32 Z08 R390 17	100	32	8	52	1,665			
T414	●	D125 d40 Z09 R390 17	125	40	9	62	3,680			
T416	●	D160 d40 Z10 R390 17	160	40	10	62	5,010			

SNDVK ucuna uygundur. / Compatible with SNDVK insert. / Kompatible für SNDVK WP



90° R390-1806

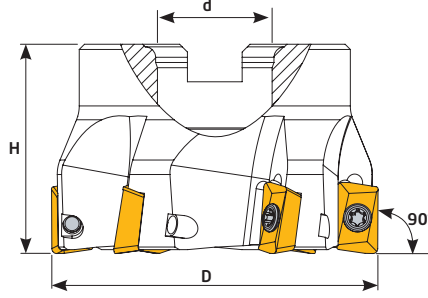

Ölçüler (mm) Dimensions(mm) Abmessungen (mm)		R390-1806	
L	s		
18	6,33		

Sipariş Kodu Order Code Best.-Nr.	Stok/Stock/Lager	Ürün Kodu Product Code Produkt-Code	Ölçüler (mm) Dimensions(mm) Abmessungen (mm)					Kullanılan Uç Insert WSP	Sıkma Cıvatası Clamp Screw Torx-Schraube	Anahtar Torx Key Torx-Schlüssel
			D	d	Z	H	kg			
T423	●	D050 d22 Z04 R390 18	50	22	4	45	0,303	R390-1806 SNDVK	TC074 M4x10	T15
T424	●	D063 d22 Z05 R390 18	63	22	5	45	0,490			
T426	●	D080 d27 Z06 R390 18	80	27	6	52	1,081			
T428	●	D100 d32 Z07 R390 18	100	32	7	52	1,595			
T430	●	D125 d40 Z08 R390 18	125	40	8	62	3,558			
T432	●	D160 d40 Z10 R390 18	160	40	10	62	4,411			

SNDVK ucuna uygundur. / Compatible with SNDVK insert. / Kompatible für SNDVK WP

90° ADMT 1204

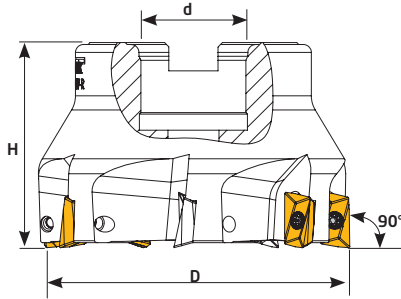

Ölçüler (mm) Dimensions(mm) Abmessungen (mm)		ADMT 1204	
L	S		
13,6	4,76		

Sipariş Kodu Order Code Best.-Nr.	Stok/Stock/Lager	Ürün Kodu Product Code Produkt-Code	Ölçüler (mm) Dimensions(mm) Abmessungen (mm)					Kullanılan Uç Insert WSP	Sıkma Cıvatası Clamp Screw Torx-Schraube	Anahtar Torx Key Torx-Schlüssel
			D	d	Z	H	kg			
T214	●	D040 d16 Z04 ADMT 12	40	16	4	45	0,280	ADMT 1204 WLTR	TC065 M3x7	T8
T215	●	D050 d22 Z05 ADMT 12	50	22	5	45	0,350			
T217	●	D063 d22 Z06 ADMT 12	63	22	6	45	0,610			
T219	●	D080 d27 Z07 ADMT 12	80	27	7	52	1,176			
T220	●	D100 d32 Z08 ADMT 12	100	32	8	52	1,595			

WLTR ucuna uygundur. / Compatible with WLTR insert. / Kompatible für WLTR WP

● Stokta/ In Stock/ Lager ○ Sınırlı Stok/ Limited Stock/ Begrenzte Lagerhaltung

Kalite için Teknik Çözüm | Technical Solution For Quality



90° ADMT 1606

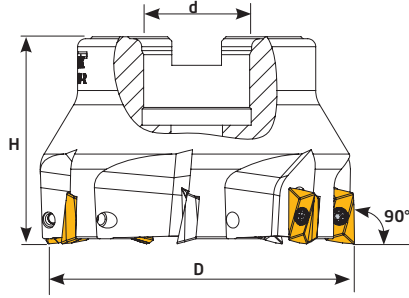

Ölçüler (mm) Dimensions(mm) Abmessungen (mm)		ADMT 1606	
L	S		
17,5	6,15		

Sipariş Kodu Order Code Best.-Nr.	Stok/Stock/Lager	Ürün Kodu Product Code Produkt-Code	Ölçüler (mm) Dimensions(mm) Abmessungen (mm)					Kullanılan Uç Insert WSP	Sıkma Cıvatası Clamp Screw Torx-Schraube	Anahtar Torx Key Torx-Schlüssel
			D	d	Z	H	kg			
T351	●	D040 d16 Z04 ADMT 16	40	16	4	45	0,258	ADMT 1606 WLTR	TC072 M4x10	T15
T352	●	D050 d22 Z05 ADMT 16	50	22	5	45	0,397			
T354	●	D063 d22 Z06 ADMT 16	63	22	6	45	0,578			
T356	●	D080 d27 Z07 ADMT 16	80	27	7	52	1,254			

WLTR ucuna uygundur. / Compatible with WLTR insert. / Kompatible für WLTR WP

90° BDMT 11T3

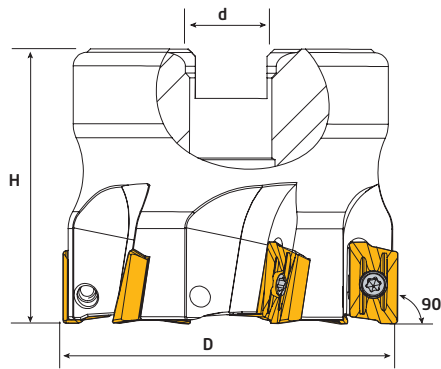

Ölçüler (mm) Dimensions(mm) Abmessungen (mm)		BDMT 11T3	
L	S		
11	3,8		

Sipariş Kodu Order Code Best.-Nr.	Stok/Stock/Lager	Ürün Kodu Product Code Produkt-Code	Ölçüler (mm) Dimensions(mm) Abmessungen (mm)					Kullanılan Uç Insert WSP	Sıkma Cıvatası Clamp Screw Torx-Schraube	Anahtar Torx Key Torx-Schlüssel
			D	d	Z	H	kg			
T533	●	D040 d16 Z05 BDMT 11	40	16	5	40	0,224	BDMT 11T3 KYCRA	TC060 M2,5x5,5	T8
T534	●	D050 d22 Z06 BDMT 11	50	22	6	40	0,361			
T535	●	D063 d22 Z07 BDMT 11	63	22	7	40	0,527			

KYCRA ucuna uygundur. / Compatible with KYCRA insert. / Kompatible für KYCRA WP



90° BDMT 1704

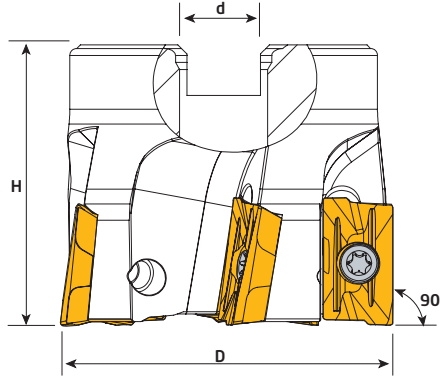
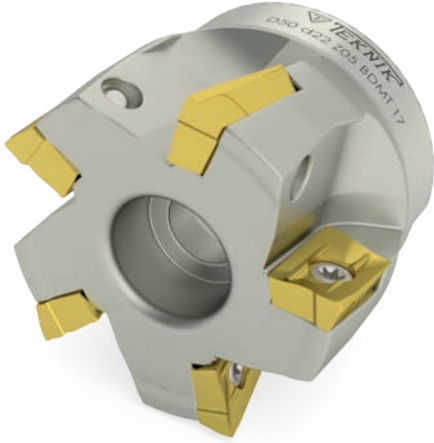

Ölçüler (mm) Dimensions(mm) Abmessungen (mm)		BDMT 1704	
L	S		
17	4,9		

Sipariş Kodu Order Code Best.-Nr.	Stok/Stock/Lager	Ürün Kodu Product Code Produkt-Code	Ölçüler (mm) Dimensions(mm) Abmessungen (mm)					Kullanılan Uç Insert WSP	Sıkma Civatası Clamp Screw Torx-Schraube	Anahtar Torx Key Torx-Schlüssel
			D	d	Z	H	KG			
T537	●	D040 d16 Z04 BDMT 17	40	16	4	40	0,190	BDMT 1704 KYCRA	TC074 M4x10	T15
T538	●	D050 d22 Z05 BDMT 17	50	22	5	40	0,312			
T539	●	D063 d22 Z06 BDMT 17	63	22	6	40	0,516			
T540	●	D080 d27 Z07 BDMT 17	80	27	7	50	1,165			

KYCRA ucuna uygundur. / Compatible with KYCRA insert. / Kompatibel für KYCRA WP

90° APKT 1705

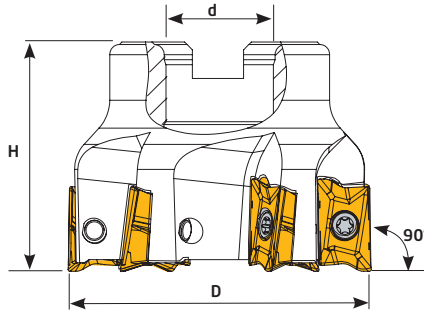

Ölçüler (mm) Dimensions(mm) Abmessungen (mm)		APKT 1705	
L	S		
17	5,56		

Sipariş Kodu Order Code Best.-Nr.	Stok/Stock/Lager	Ürün Kodu Product Code Produkt-Code	Ölçüler (mm) Dimensions(mm) Abmessungen (mm)					Kullanılan Uç Insert WSP	Sıkma Civatası Clamp Screw Torx-Schraube	Anahtar Torx Key Torx-Schlüssel
			D	d	Z	H	KG			
T550	●	D040 d16 Z04 APKT 17	40	16	4	45	0,239	APKT 1705 TGTC	TC074 M4x10	T15
T552	●	D050 d22 Z05 APKT 17	50	22	5	45	0,362			
T554	●	D063 d22 Z06 APKT 17	63	22	6	45	0,520			
T556	●	D080 d27 Z07 APKT 17	80	27	7	50	1,047			
T558	●	D100 d32 Z08 APKT 17	100	32	8	52	1,620			

TGTC ucuna uygundur. / Compatible with TGTC insert. / Kompatibel für TGTC WP

● Stokta/ In Stock/ Lager ○ Sınırlı Stok/ Limited Stock/ Begrenzte Lagerhaltung

Kalite için Teknik Çözüm | Technical Solution For Quality



www.teknikcuttingtools.com

90° ADKT 1505

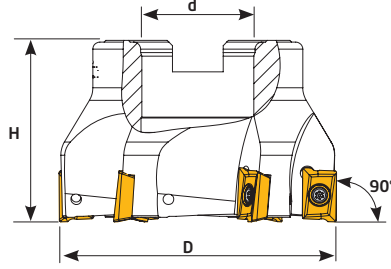

Ölçüler (mm) Dimensions(mm) Abmessungen (mm)		ADKT 1505	
L	S		
15,7	5,63		

Sipariş Kodu Order Code Best.-Nr.	Stok/Stock/Lager	Ürün Kodu Product Code Produkt-Code	Ölçüler (mm) Dimensions(mm) Abmessungen (mm)					Kullanılan Uç Insert WSP	Sıkma Civatası Clamp Scr Torx-Schraube	Anahtar Torx Key / Torx-Schlüssel
			D	d	Z	H	WSP			
T200	●	D040 d16 Z04 ADKT 15	40	16	4	45	0,270	ADKT 1505 ISCR	TC074 M4x10	T15
T202	●	D050 d22 Z05 ADKT 15	50	22	5	45	0,394			
T204	●	D063 d22 Z06 ADKT 15	63	22	6	45	0,565			
T206	●	D080 d27 Z07 ADKT 15	80	27	7	52	1,152			
T207	●	D100 d32 Z08 ADKT 15	100	32	8	52	1,546			
T208	●	D125 d40 Z09 ADKT 15	125	40	9	62	0,272			

ISCR ucuna uygundur. / Compatible with ISCR insert. / Kompatibel für ISCR WP

90° BOMT 1304

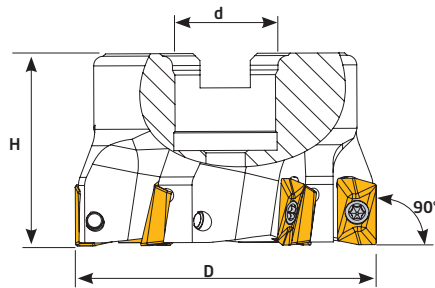

Ölçüler (mm) Dimensions(mm) Abmessungen (mm)			BOMT 1304	
L	S	A		
13	4,5	8		

Sipariş Kodu Order Code Best.-Nr.	Stok/Stock/Lager	Ürün Kodu Product Code Produkt-Code	Ölçüler (mm) Dimensions(mm) Abmessungen (mm)					Kullanılan Uç Insert WSP	Sıkma Civatası Clamp Screw Torx-Schraube	Anahtar Torx Key Torx-Schlüssel
			D	d	Z	H	WSP			
T965	●	D040 d16 Z04 BOMT 13	40	16	4	40	0,272	BOMT 1304 INGRSLL	TC069 M3,5x8,5	T10
T966	●	D050 d22 Z05 BOMT 13	50	22	5	40	0,369			
T967	●	D063 d22 Z06 BOMT 13	63	22	6	40	0,613			

INGRSLL ucuna uygundur. / Compatible with INGRSLL insert. / Kompatibel für INGRSLL WP



APKT 16 HAVŞA Chamfer End Mills

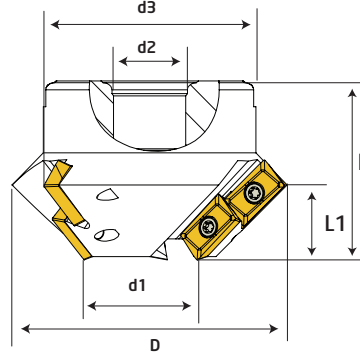

Ölçüler (mm) Dimensions(mm) Abmessungen (mm)		APKT 1604	
L	s		
16,4	4,76		

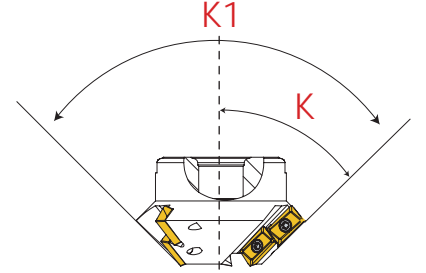

Sipariş Kodu Order Code Best.-Nr.	Stok/Stock/Lager	Ürün Kodu Product Code Produkt-Code	Ölçüler (mm) Dimensions(mm) Abmessungen (mm)									Kullanılan Uç Insert WSP	Sıkma Civatası Clamp Screw Torx-Schraube	Anahtar Torx Key Torx-Schlüssel	
			K	K1	d1	D	Z	d2	d3	L	L1				
T457	●	35-50,5 Z06 K15° APKT 16	15°	30°	35	50,5	6	22	45	60	30	0,415			
T454	●	35-65 Z06 K30° APKT 16	30°	60°	35	65	6	27	48	50	26,3	0,610			
T456	●	35-76 Z06 K45° APKT 16	45°	90°	35	76	6	27	60	50	21,5	0,734			
T455	●	35-86 Z06 K60° APKT 16	60°	120°	35	86	6	27	60	50	15	0,892			
T458	●	35-94 Z06 K75° APKT 16	75°	150°	35	94	6	27	60	50	8,5	1,256			

KRLY ucuna uygundur. / Compatible with KRLY insert. / Kompatibel für KRLY WP

F 75° APKT 1604 -APXT 1003

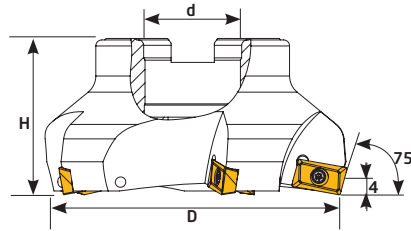
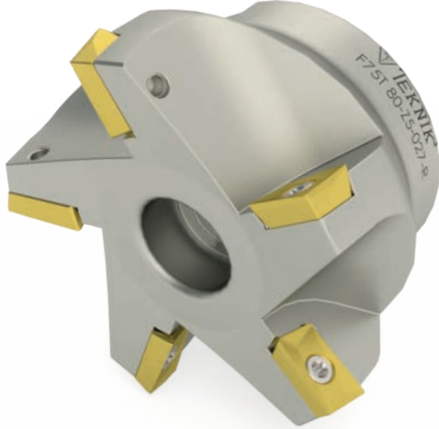

Ölçüler (mm) Dimensions(mm) Abmessungen (mm)		APKT 1604 APXT 1003	
L	s		
16,4	4,76		
10	3,52		

Sipariş Kodu Order Code Best.-Nr.	Stok/Stock/Lager	Ürün Kodu Product Code Produkt-Code	Ölçüler (mm) Dimensions(mm) Abmessungen (mm)					Kullanılan Uç Insert WSP	Sıkma Civatası Clamp Screw Torx-Schraube	Anahtar Torx Key Torx-Schlüssel
			D	d	Z	H				
T308	●	D063 d22 Z04 APKT 16	63	22	4	45	0,510			
T310	●	D080 d27 Z05 APKT 16	80	27	5	52	1,120			
T312	●	D100 d32 Z06 APKT 16	100	32	6	52	1,587			
T313	●	D125 d40 Z07 APKT 16	125	40	7	62	3,047			
T452	●	D063 d22 Z06 APXT 10	63	22	6	45	0,630	APXT 1003 KRLY	TC63 M2,5x7	T8

KRLY ucuna uygundur. / Compatible with KRLY insert. / Kompatibel für KRLY WP

● Stokta/In Stock/Lager ○ Sınırlı Stok/Limited Stock/Begrenzte Lagerhaltung

Kalite için Teknik Çözüm | Technical Solution For Quality

F 75° ADKT 1505

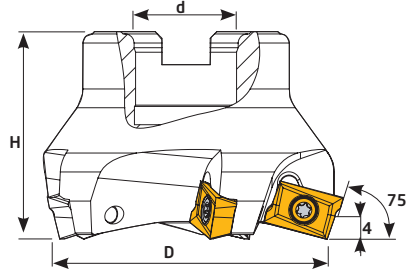

Ölçüler (mm) Dimensions(mm) Abmessungen (mm)		ADKT 1505	
L	S		
15,7	5,63		

Sipariş Kodu Order Code Best.-Nr.	Stok/Stock/Lager	Ürün Kodu Product Code Produkt-Code	Ölçüler (mm) Dimensions(mm) Abmessungen (mm)					Kullanılan Uç Insert /WSP	Sıkma Cıvatası Clamp Scr /Torx-Schraube	Anahtar Torx Key / Torx-Schlüssel
			D	d	Z	H	kg			
T530	●	D063 d22 Z05 ADKT 15	63	22	5	45	0,580	ADKT 1505 ISCR	TC074 M4x10	T15
T532	●	D080 d27 Z06 ADKT 15	80	27	6	50	1,090			

ISCR ucuna uygundur. / Compatible with ISCR insert. / Kompatibel für ISCR WP

90° VCGT 1604

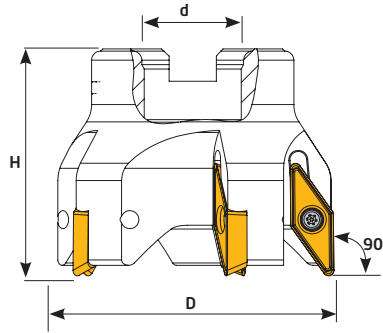

Ölçüler (mm) Dimensions(mm) Abmessungen (mm)		VCGT 1604	
L	S		
16,6	4,76		

Sipariş Kodu Order Code Best.-Nr.	Stok/Stock/Lager	Ürün Kodu Product Code Produkt-Code	Ölçüler (mm) Dimensions(mm) Abmessungen (mm)					Kullanılan Uç Insert WSP	Sıkma Cıvatası Clamp Screw Torx-Schraube	Anahtar Torx Key Torx-Schlüssel
			D	d	Z	H	kg			
T498	●	D040 d16 Z03 VCGT 16	40	16	3	52	0,277	VCGT 1604 ISO	TC074 M4x10	T15
T500	●	D050 d22 Z04 VCGT 16	50	22	4	52	0,362			
T502	●	D063 d22 Z05 VCGT 16	63	22	5	52	0,538			
T504	●	D080 d27 Z06 VCGT 16	80	27	6	52	0,848			



90° TPKN 1603-2204

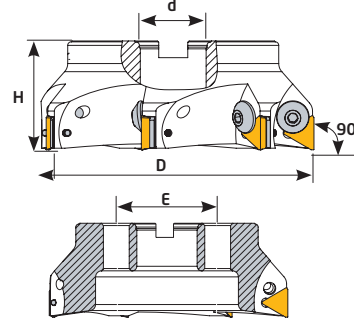
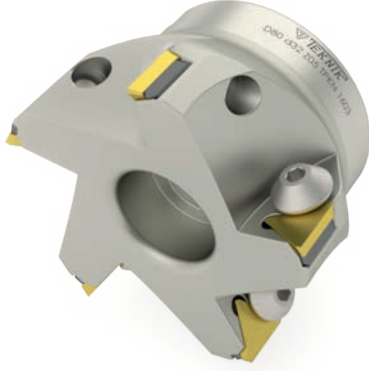

Ölçüler (mm) Dimensions(mm) Abmessungen (mm)		TPKN 1603
L	S	
12,7	3,18	
22	4,76	

Altlıklı - With Shim - Mit U-Platte

Sipariş Kodu Order Code Best.-Nr.	Stok/Stock/Lager	Ürün Kodu Product Code Produkt-Code	Ölçüler (mm) Dimensions(mm) Abmessungen (mm)						Kullanılan Uç Insert WSP	Baskı Cıvatası Locking Screw Verriegelungs-Schraube	Altlık Shim U-Platte	Altlık Cıvatası Shim Screw Inbuss-Schraube	Anahtar Allen Key Inbuss-Schlüssel
			ØD	ød	Z	H	E						
T100	●	D080 d32 Z05 TPKN 16 A	80	32	5	52	--	0,961	TPKN 1603 ISO		TA010	TC034 M3	4 Allen
T102	●	D100 d32 Z06 TPKN 16 A	100	32	6	52	--	1,518					
T104	●	D080 d32 Z04 TPKN 22 A	80	32	4	52	--	0,810	TPKN 2204 ISO		TA012	TC038 M4x10	5 Allen
T106	●	D100 d32 Z05 TPKN 22 A	100	32	5	52	--	1,444					
T108	●	D125 d40 Z06 TPKN 22 A	125	40	6	62	--	3,164					
T110	●	D160 d40 Z07 TPKN 22 A	160	40	7	62	66,7	4,220					
T112	●	D200 d60 Z08 TPKN 22A	200	60	8	62	101,6	5,412					
T113	●	D250 d60 Z09 TPKN 22 A	250	60	9	62	101,6	8,166					

90° TPKN 1603-2204

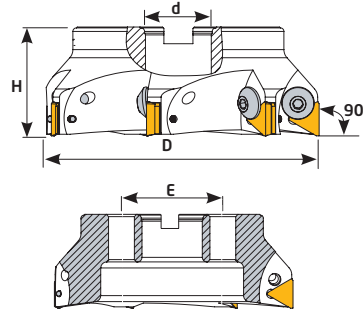

Ölçüler (mm) Dimensions(mm) Abmessungen (mm)		TPKN 1603
L	S	
12,7	3,18	
22	4,76	

Sipariş Kodu Order Code Best.-Nr.	Stok/Stock/Lager	Ürün Kodu Product Code Produkt-Code	Ölçüler (mm) Dimensions(mm) Abmessungen (mm)						Kullanılan Uç Insert WSP	Sıkma Cıvatası Clamp Screw Inbuss-Schraube	Anahtar Allen Key Inbuss-Schlüssel
			ØD	ød	Z	H	E				
T114	●	D042 d16 Z03 TPKN 16	42	16	3	44	--	0,280	TPKN 1603 ISO		4 Allen
T116	●	D050 d22 Z03 TPKN 16	50	22	3	44	--	0,340			
T118	●	D063 d22 Z03 TPKN 16	63	22	3	44	--	0,463			
T120	●	D063 d22 Z04 TPKN 16	63	22	4	44	--	0,481			
T122	●	D080 d32 Z05 TPKN 16	80	32	5	52	--	0,954			
T124	●	D100 d32 Z06 TPKN 16	100	32	6	52	--	1,542			
T126	●	D063 d22 Z03 TPKN 22	63	22	3	50	--	0,532	TPKN 2204 ISO		5 Allen
T128	●	D080 d32 Z04 TPKN 22	80	32	4	52	--	0,795			
T130	●	D100 d32 Z05 TPKN 22	100	32	5	52	--	1,398			
T132	●	D125 d40 Z06 TPKN 22	125	40	6	62	--	3,153			
T134	●	D160 d40 Z07 TPKN 22	160	40	7	62	66,7	4,150			
T136	●	D200 d60 Z08 TPKN 22	200	60	8	62	101,6	5,458			
T138	●	D250 d60 Z09 TPKN 22	250	60	9	62	101,6	8,235			

● Stokta/ In Stock/ Lager ○ Sınırlı Stok/ Limited Stock/ Begrenzte Lagerhaltung

Kalite için Teknik Çözüm | Technical Solution For Quality



www.teknikcuttingtools.com

75° SPKN 1203

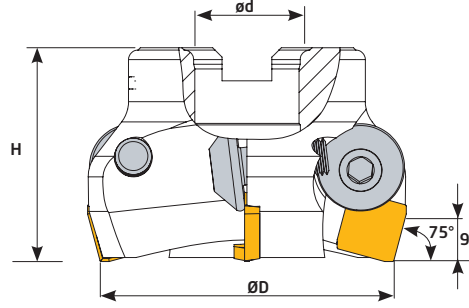

Ölçüler (mm) Dimensions(mm) Abmessungen (mm)		SPKN 1203	
L	S		
12,7	3,18		

Sipariş Kodu Order Code Best.-Nr.	Stok/Stock/Lager	Ürün Kodu Product Code Produkt-Code	Ölçüler (mm) Dimensions(mm) Abmessungen (mm)					Kullanılan Uç Insert WSP	Sıkma Cıvatası Clamp Screw Inbuss-Schraube	Anahtar Allen Key Inbuss-Schlüssel
			ØD	ød	Z	H	Ⓢ			
T148	●	D050 d22 Z03 SPKN 12	50	22	3	45	0,385	SPKN 1203 ISO	TC054 M8x24	5 Allen
T150	●	D063 d22 Z04 SPKN 12	63	22	4	45	0,600			

75° SPKN 1203

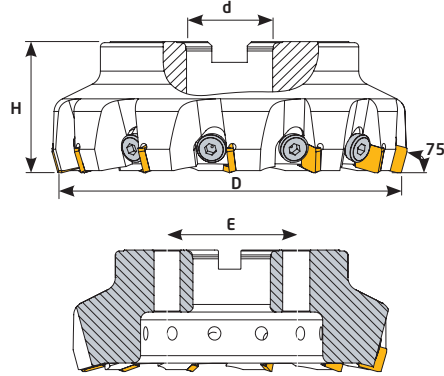

Ölçüler (mm) Dimensions(mm) Abmessungen (mm)		SPKN 1203	
L	S		
12,7	3,18		

Sipariş Kodu Order Code Best.-Nr.	Stok/Stock/Lager	Ürün Kodu Product Code Produkt-Code	Ölçüler (mm) Dimensions(mm) Abmessungen (mm)						Kullanılan Uç Insert WSP	Sıkma Cıvatası Clamp Screw Inbuss-Schraube	Anahtar Allen Key Inbuss-Schlüssel
			ØD	ød	Z	H	E	Ⓢ			
T152	●	D080 d27 Z06 SPKN 12	80	27	6	55	---	1,260	SPKN 1203 ISO	TC056 Sol M8x24-L	5 Allen
T154	●	D100 d32 Z08 SPKN 12	100	32	8	55	---	1,698			
T156	●	D125 d40 Z10 SPKN 12	125	40	10	62	---	3,400			
T158	●	D160 d40 Z12 SPKN 12	160	40	12	62	66,7	5,012			
T160	●	D200 d60 Z12 SPKN 12	200	60	12	62	101,6	6,542			
T162	●	D300 d60 Z20 SPKN 12	300	60	20	65	101,6	15,11			



Baralar Boring Tools Ausbohrwerkzeug



Technical Solution
for Quality



Technical Solution For Quality | teknikcuttingtools.com

Hassas Bara Set | Boring Tools Finish Set

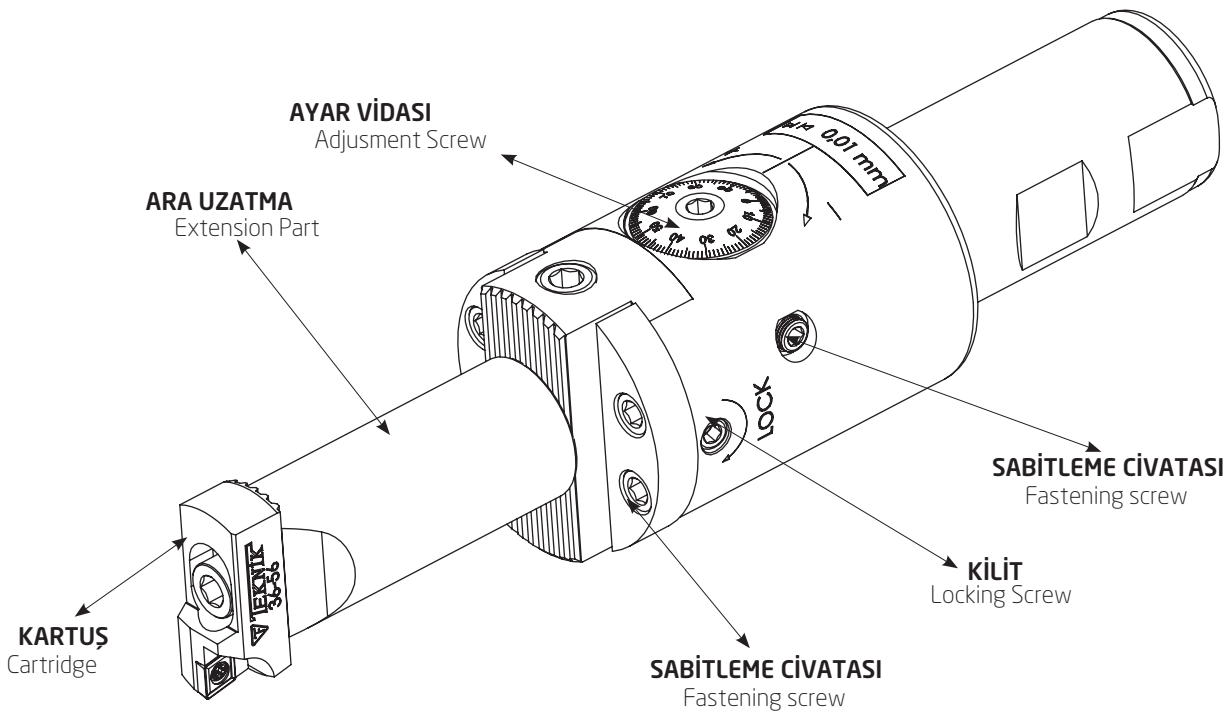
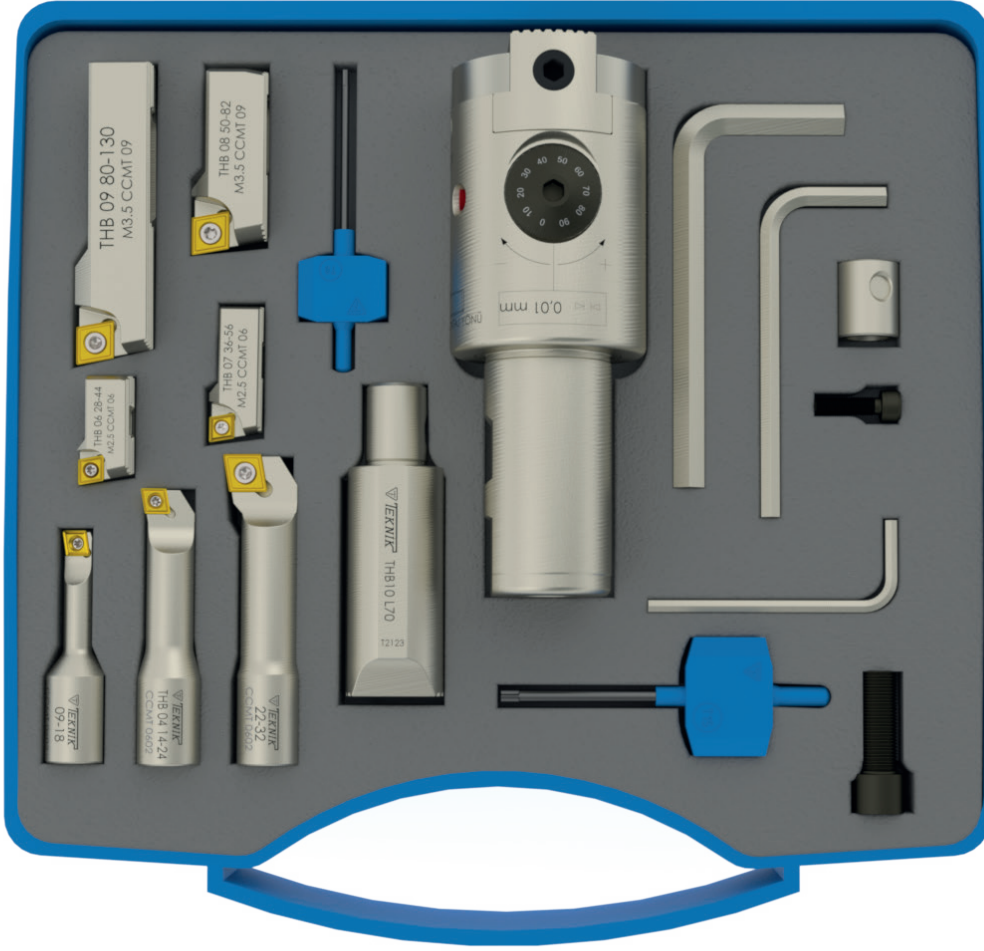

THB 01 SET 9-130 mm Arası

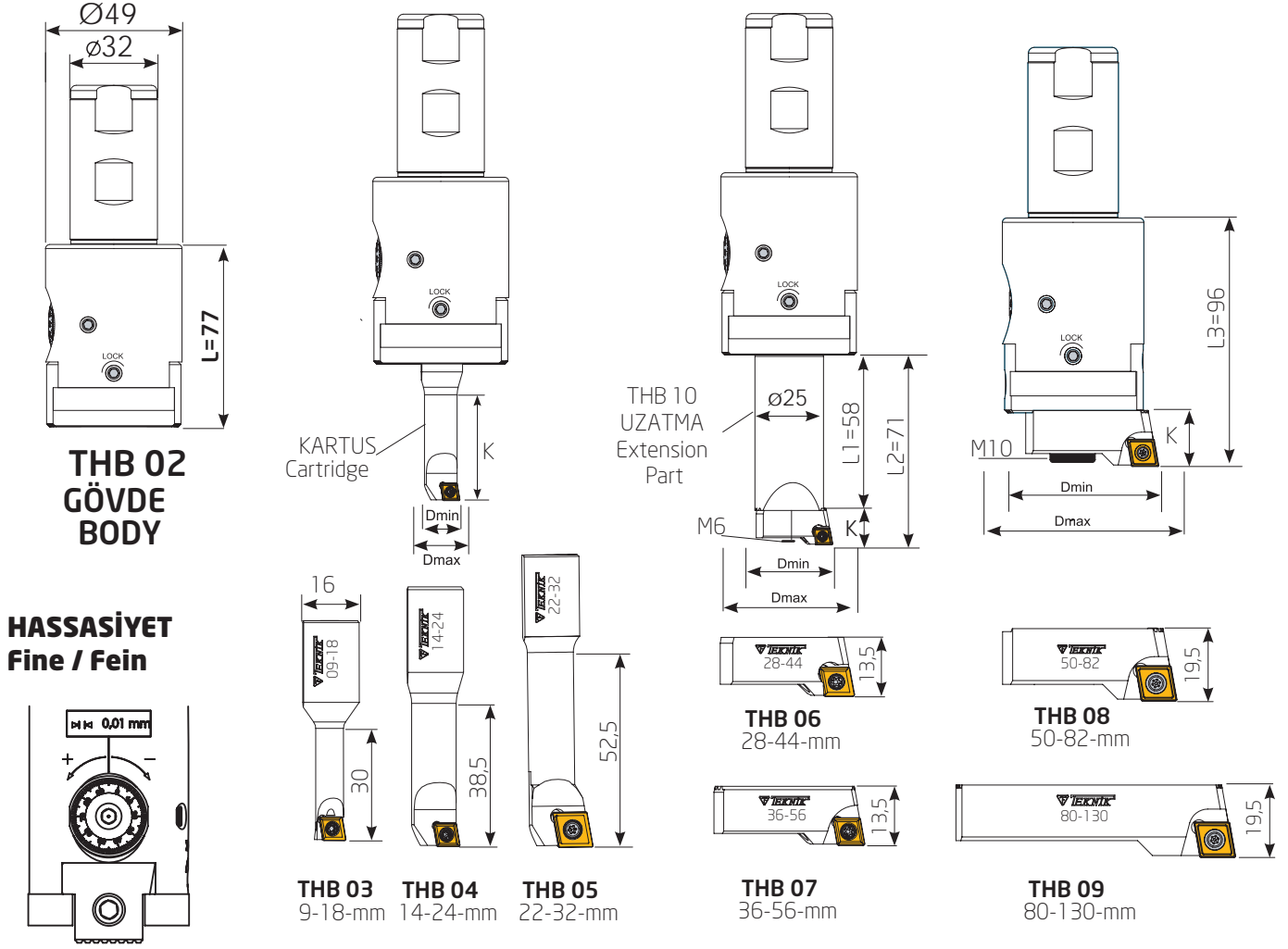

Sipariş Kodu Order Code Best.-Nr.	Stok/Stock/Lager	Ürün Kodu Product Code Produkt-Code	Ölçüler (mm) Dimensions(mm) Abmessungen (mm)						Kullanılan Uç Insert WSP	Sıkma Civatası Clamp Screw Torx-Schraube	Anahtar Torx Key Torx-Schlüssel
			K	L1	L2	L3	Dmin - Dmax				
THB01	●	HASSAS BARA SETİ / SET	9-130	3,100
THB02	●	GÖVDE / BODY	-
THB03	●	09-18 Kartuş/Cartridge	32,5	9-18	-	CCMT 0602	TC059-1 M2,5x4,7	T8
THB04	●	14-24 Kartuş/Cartridge	39,6	14-24	-			
THB05	●	22-32 Kartuş /Cartridge	52,5	22-32	-	CCMT 09T3	TC067 M3,5x8,5	T15
THB06	●	28-44 Kartuş/Cartridge	13,7	...	71	...	28-44	-	CCMT 0602	TC060 M2,5x5,5	T8
THB07	●	36-56 Kartuş /Cartridge	13,7	...	71	...	36-56	-			
THB08	●	50-82 Kartuş/Cartridge	19,5	95,5	50-82	-	CCMT 09T3	TC067 M3,5x9	T15
THB09	●	80-130 Kartuş/Cartridge	19,5	95,5	80-130	-			
THB10	●	ARA UZATMA/Extension Part	...	58	-

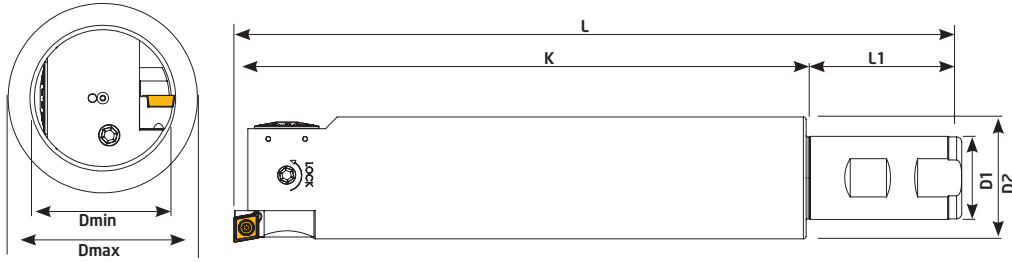

Sipariş Kodu Order Code Best.-Nr.	Stok/Stock/Lager	Ürün Kodu Product Code Produkt-Code	Ölçüler (mm) Dimensions(mm) Abmessungen (mm)								Kullanılan Uç Insert WSP	Hassasiyet Fine Fein
			Dmin	Dmax	K	D1	L1	D2	L	kg		
THKB120	●	25-32 K050 CCMT 06	25	32	50	25	56	23	106	0,402	CCMT0602	0,02
THKB122	●	25-32 K100 CCMT 06	25	32	100	25	56	23	156	0,570		
THKB126	●	32-40 K060 CCMT 06	32	40	60	25	56	29	116	0,510		
THKB128	●	32-40 K104 CCMT 06	32	40	104	25	56	29	160	0,760		
THKB132	●	40-50 K069 CCMT 06	40	50	69	25	56	36	125	0,722		
THKB134	●	40-50 K109 CCMT 06	40	50	109	25	56	36	165	1,085		
THKB136	●	40-50 K189 CCMT 06	40	50	189	25	56	36	245	1,723		
THKB138	●	50-65 K065 CCMT 09	50	65	65	32	60	47	125	1,231	CCMT09T3	0,01
THKB140	●	50-65 K130 CCMT 09	50	65	130	32	60	47	190	2,135		
THKB142	●	50-65 K220 CCMT 09	50	65	220	32	60	47	280	3,383		
THKB144	●	65-80 K085 CCMT 09	65	80	85	32	60	60	145	1,900		
THKB146	●	65-80 K130 CCMT 09	65	80	130	32	60	60	190	2,547		
THKB148	●	65-80 K220 CCMT 09	65	80	220	32	60	60	280	3,895		



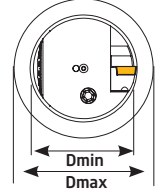
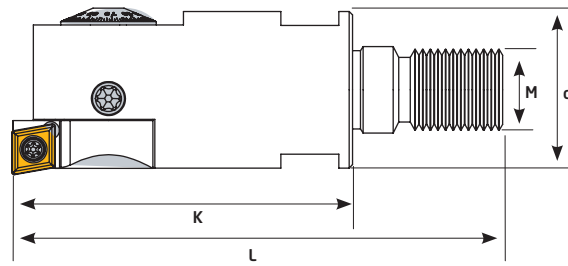

Sipariş Kodu Order Code Best.-Nr.	Stok/Stock/Lager	Ürün Kodu Product Code Produkt-Code	Ölçüler (mm) Dimensions(mm) Abmessungen (mm)							Kullanılan Uç Insert WSP	HASSASİYET Fine Fein
			Dmin	Dmax	M	K	L	d	ISO		
THKB102	●	25-32 K050 M12 CCMT 06	25	32	M12	50	72	23	0,194	CCMT 0602	0,02
THKB104	●	32-40 K050 M16 CCMT 06	32	40	M16	50	74,3	29	0,287		0,01

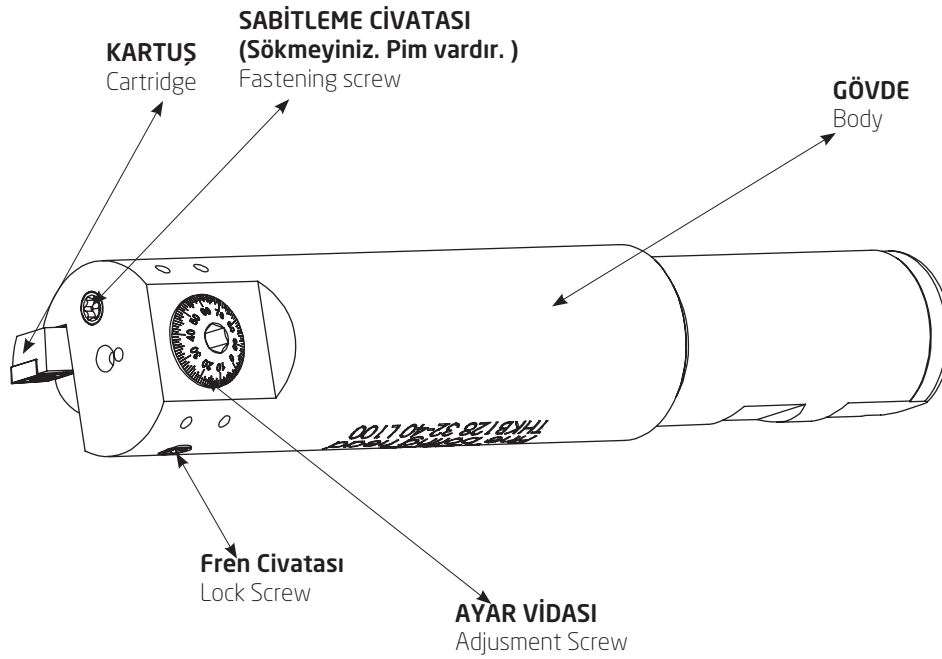

Dmin-Dmax	Kartuşlar Cartridges Kartusche	Kullanılan Uç Insert WSP	Sıkma Cıvatası Clamp Screw Torx-Schraube	Sabitleme Cıvatası Locking Screw Verriegelungs Schraube	Ayar Cıvatası Adjustment Screw Einstellschraube	Anahtar Torx Key Torx-Schlüssel
25-32	KR150	CCMT 0602	TC060 M2,5x5,5	SK47-M6x6	PC14-M5x17	T8 2,5 Allen
32-40	KR151	CCMT 0602	TC060 M2,5x5,5	SK47-M6x6	PC16-M5x19	T8 2,5 Allen
40-50	KR152	CCMT 0602	TC060 M2,5x5,5	SK47-M6x6	PC18-M5x23	T8 --
50-65	KR153	CCMT 09T3	TC067 M3,5x9	SK48-M8x8	PC22-M8x37	T15 --
65-80	KR154	CCMT 09T3	TC067 M3,5x9	SK48-M8x8	PC22-M8x37	T15 --

● Stokta/In Stock/Lager ○ Sınırlı Stok/Limited Stock/Begrenzte Lagerhaltung

Kalite için Teknik Çözüm | Technical Solution For Quality



www.teknikcuttingtools.com

- 120-300 mm Finiş Bara ● 120-300 mm Boring Tools Finish
- 120-300 mm Ausdrehwerkzeug für die Fertigbearbeitung

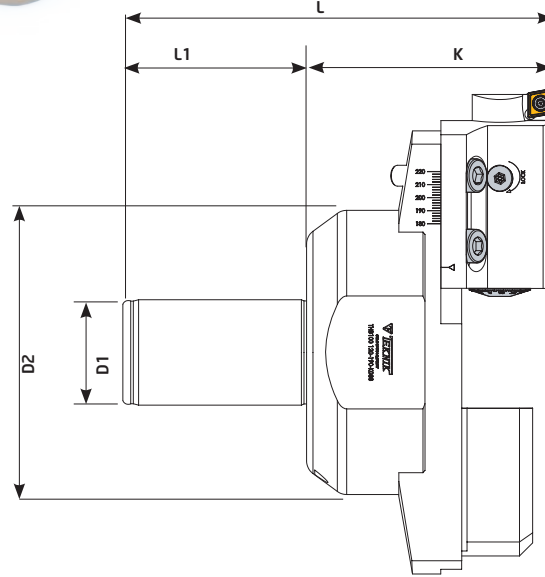
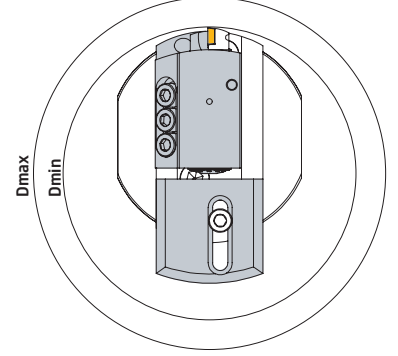

HASSASİYET
Fine / Fein

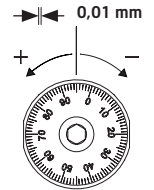

Sipariş Kodu Order Code Best.-Nr.	Stok/Stock/Lager	Ürün Kodu Product Code Produkt-Code	Ölçüler (mm) Dimensions(mm) Abmessungen (mm)								Kullanılan Uç Insert WSP	HASSASİYET Fine Fein
			Dmin	Dmax	K	D1	L1	D2	L			
THB100	●	120-190 K093 CCMT 09	120	190	93,7	40	70	109	163,7	5,060		0,01
THB101	●	180-240 K093 CCMT 09	180	240	93,7	40	70	109	163,7	5,967		
THB102	●	240-300 K093 CCMT 09	240	300	93,7	40	70	109	163,7	7,000		



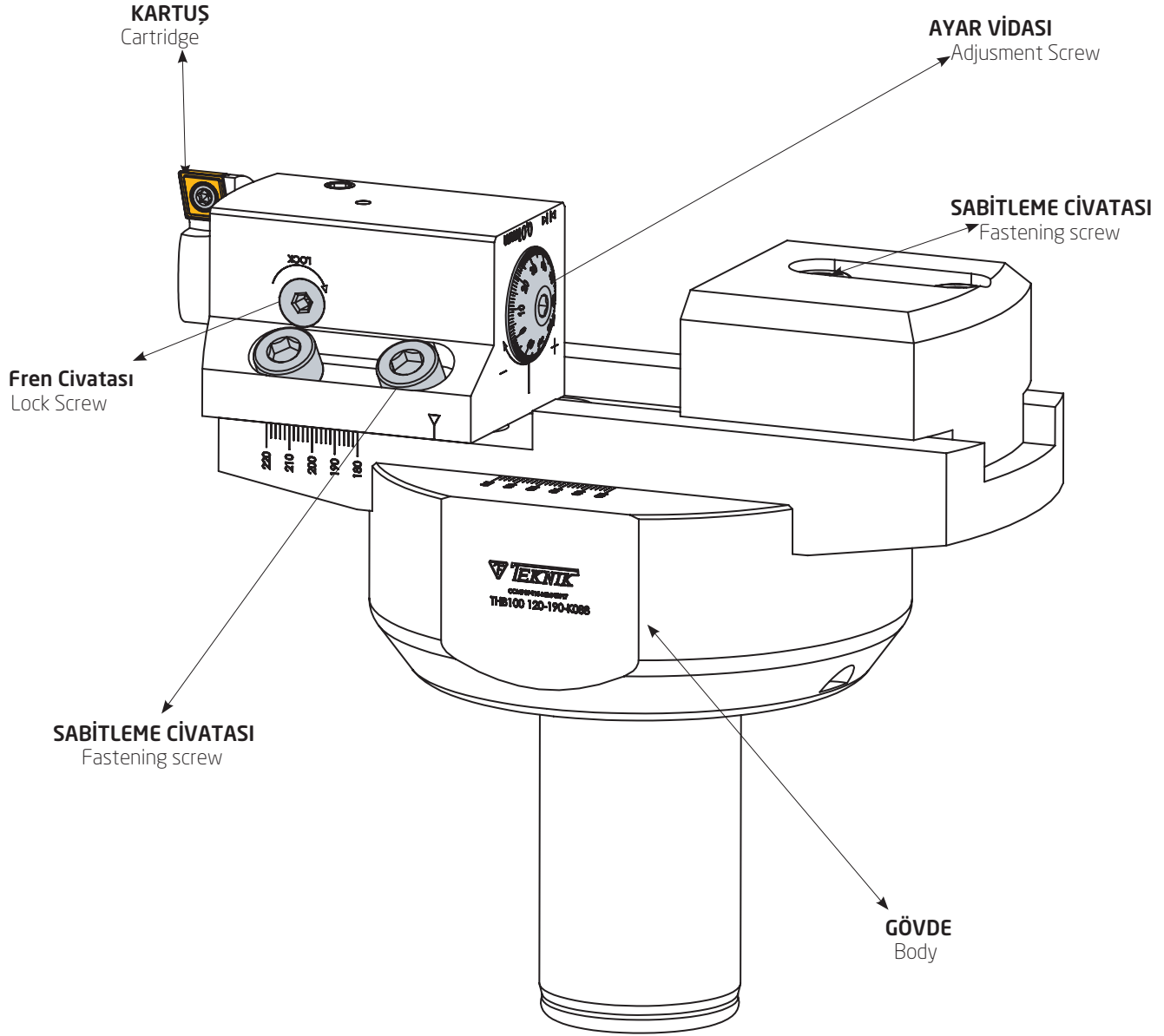

Dmin-Dmax	Mikro Bara Kartuş Micro Boring Cartridge	Kullanılan Uç Insert WSP	Sıkma Cıvatası Clamp Screw Torx-Schraube	Sabitleme Cıvatası Locking Screw Verriegelungs Schraube	Anahtar Torx Key Torx Schlüssel	
120-190	KR127	CCMT 09T3	TC067 M3,5x9	TC108-M8x30	SK45-M10x7,5	T15
180-240	KR127		TC067 M3,5x9	TC108-M8x30	SK45-M10x7,5	T15
240-300	KR127		TC067 M3,5x9	TC108-M8x30	SK45-M10x7,5	T15

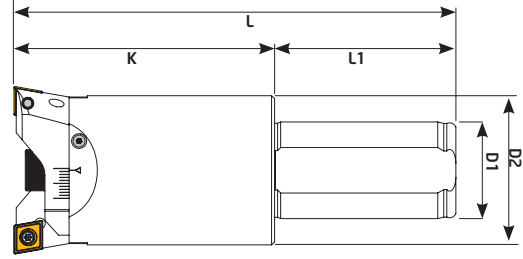
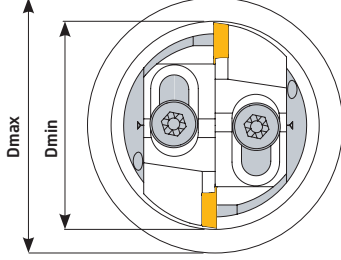

Sipariş Kodu Order Code Best.-Nr.	Stok/Stock/Lager	Ürün Kodu Product Code Produkt-Code	Ölçüler (mm) Dimensions(mm) Abmessungen (mm)								Kullanılan Uç Insert WSP
			Dmin	Dmax	K	D1	L1	D2	L	kg	
TKB088	●	16-20 K052 WCMX 03	16	20	52	16	48	15,7	100	0,176	WCMX 0302
TKB090	●	16-20 K102 WCMX 03	16	20	102	16	48	15,7	150	0,237	
TKB092	●	16-20 K152 WCMX 03	16	20	152	16	48	15,7	200	0,362	
TKB094	●	19-23 K052 CCMT 06	19	23	52	16	48	17,7	100	0,192	CCMT 0602
TKB096	●	19-23 K102 CCMT 06	19	23	102	16	48	17,7	150	0,292	
TKB098	●	19-23 K152 CCMT 06	19	23	152	16	48	17,7	200	0,401	
TKB100	●	23-28 K050 CCMT 06	23	28	50	20	50	21,2	100	0,298	
TKB102	●	23-28 K100 CCMT 06	23	28	100	20	50	21,2	150	0,347	
TKB104	●	23-28 K185 CCMT 06	23	28	185	20	50	21,2	235	0,682	
TKB106	●	28-38 K055 CCMT 09	28	38	55	20	50	25,7	105	0,378	CCMT 09T3
TKB108	●	28-38 K105 CCMT 09	28	38	105	20	50	25,7	155	0,376	
TKB110	●	28-38 K174 CCMT 09	28	38	174	25	56	25,7	230	0,267	
TKB111	●	28-38 K274 CCMT 09	28	38	274	25	56	25,7	330	1,342	
TKB112	●	37-48 K064 CCMT 09	37	48	64	25	56	32	120	0,661	
TKB114	●	37-48 K114 CCMT 09	37	48	114	25	56	33	170	0,991	
TKB116	●	37-48 K204 CCMT 09	37	48	204	25	56	33	260	1,597	
TKB118	●	45-56 K070 CCMT 09	45	56	70	32	60	39,5	130	1,035	
TKB120	●	45-56 K120 CCMT 09	45	56	120	32	60	40	180	1,528	
TKB122	●	45-56 K200 CCMT 09	45	56	200	32	60	40	260	2,385	
TKB124	●	55-75 K085 CCMT 09	55	75	85	32	60	50	145	1,638	
TKB126	●	55-75 K135 CCMT 09	55	75	135	32	60	50	195	2,422	
TKB128	●	55-75 K220 CCMT 09	55	75	220	32	60	50	280	3,745	
TKB130	●	70-90 K085 CCMT 09	70	90	85	32	60	64	145	2,100	
TKB132	●	70-90 K135 CCMT 09	70	90	135	32	60	64	195	2,942	
TKB134	●	70-90 K220 CCMT 09	70	90	220	40	70	64	290	4,915	
TKB136	●	90-130 K115 CCMT 09	90	130	115	32	60	74	175	3,130	
TKB138	●	90-130 K165 CCMT 09	90	130	165	32	60	74	225	4,138	



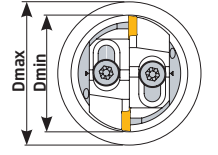
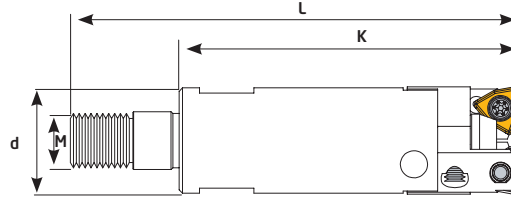

Sipariş Kodu Order Code Best.-Nr.	Stok/Stock/Lager	Ürün Kodu Product Code Produkt-Code	Ölçüler (mm) Dimensions(mm) Abmessungen (mm)							Kullanılan Uç Insert WSP
			Dmin	Dmax	M	K	L	d	kg	
TKB170	●	16-20 K050 M08 WCMX 03	16	20	M8	50	66	15,5	0,078	WCMX 0302
TKB172	●	19-23 K050 M10 CCMT 06	19	23	M10	50	70	17,5	0,095	CCMT 0602
TKB174	●	23-28 K050 M12 CCMT 06	23	28	M12	50	72	21,2	0,145	CCMT 0602
TKB176	●	28-38 K050 M16 CCMT 09	28	38	M16	50	74,5	25,7	0,213	CCMT 09T3

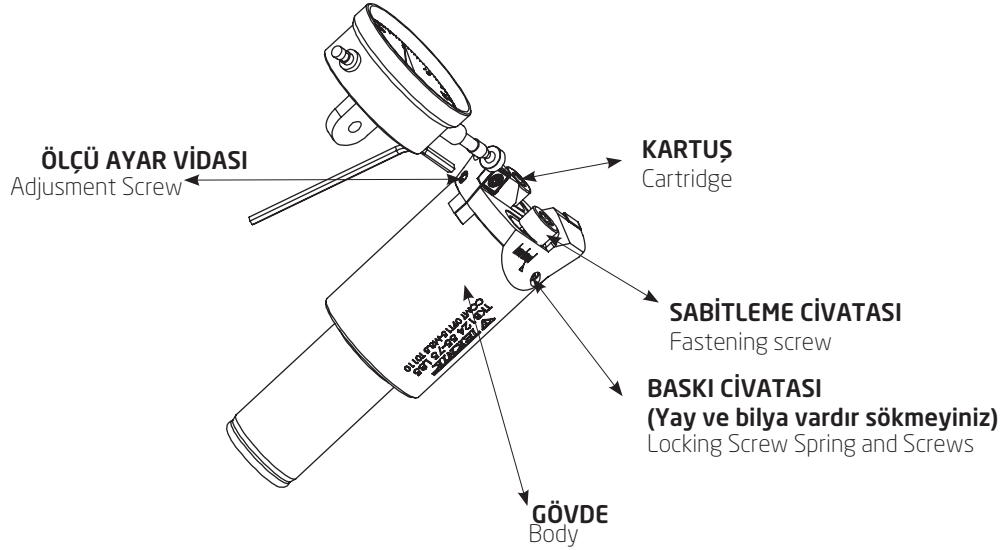

Dmin-Dmax	Kartuşlar Cartridges Kartusche	Kullanılan Uç Insert WSP	Sıkma Cıvatası Clamp Screw Torx-Schraube	Sabitleme Cıvatası Locking Screw Verriegelungs Schraube	Ayar Cıvatası Adjustment Screw Einstellschraube	Anahtar Torx Key Torx-Schlüssel
16-20	KR096	WCMX 0302	TC060 M2,5x5,5	TC102-M4x16	SK29-M3x4	T8
19-23	KR098	CCMT 0602	TC060 M2,5x5,5	TC102-M4x16	SK30-M3x5	T8
23-28	KR100	CCMT 0602	TC060 M2,5x5,5	TC104-M5x25	SK30-M3x5	T8
28-38	KR102	CCMT 09T3	TC067 M3,5x9	TC104-M5x25	SK32-M4x7	T15
37-48	KR104	CCMT 09T3	TC067 M3,5x9	TC106-M6x30	SK34-M4x10	T15
45-56	KR106	CCMT 09T3	TC067 M3,5x9	TC108-M8x30	SK36-M4x12	T15
55-75	KR108	CCMT 09T3	TC067 M3,5x9	TC108-M8x30	SK38-M4x16	T15
70-90	KR110	CCMT 09T3	TC067 M3,5x9	TC108-M8x30	SK38-M4x16	T15
90-130	KR112	CCMT 09T3	TC067 M3,5x9	TC108-M8x30	SK40-M4x25	T15
55-75	KR115	CCMT 1204	TC083 M5x12	TC108-M8x30	SK38-M4x16	T20
70-90	KR116	CCMT 1204	TC083 M5x12	TC108-M8x30	SK38-M4x16	T20
90-130	KR117	CCMT 1204	TC083 M5x12	TC108-M8x30	SK40-M4x25	T20

● Stokta/ In Stock/ Lager ○ Sınırlı Stok/ Limited Stock/ Begrenzte Lagerhaltung

Kalite için Teknik Çözüm | Technical Solution For Quality



BROTECH

TEKNİK
Cutting Tools

www.teknikcuttingtools.com

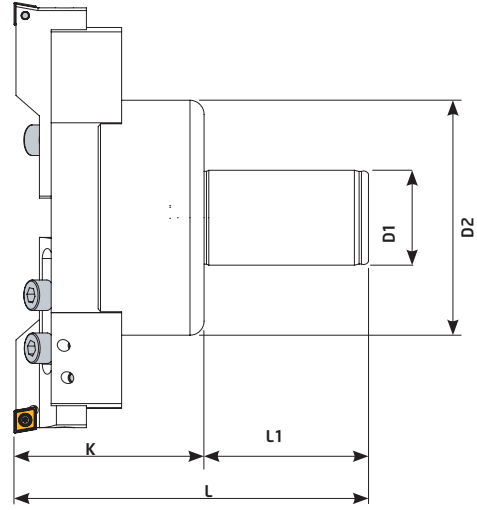
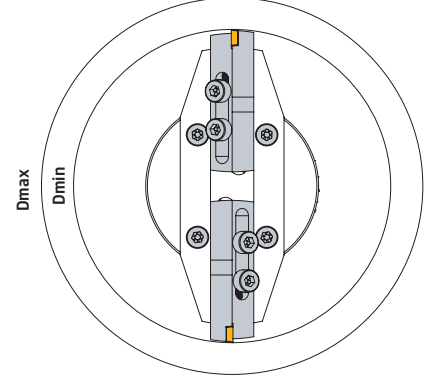
59



Sipariş Kodu Order Code Best.-Nr.	Stok/Stock/Lager	Ürün Kodu Product Code Produkt-Code	Ölçüler (mm) Dimensions(mm) Abmessungen (mm)								Kullanılan Uç Insert WSP
			Dmin	Dmax	K	D1	L1	D2	L		
TKB148	●	120-170 K069 CCMT 12	120	170	69	40	70	115,5	139	3,281	CCMT 1204
TKB150	●	170-250 K084 CCMT 12	170	250	84	40	70	99,5	154	5,011	
TKB152	●	240-350 K084 CCMT 12	240	350	84	40	70	149,5	154	8,294	



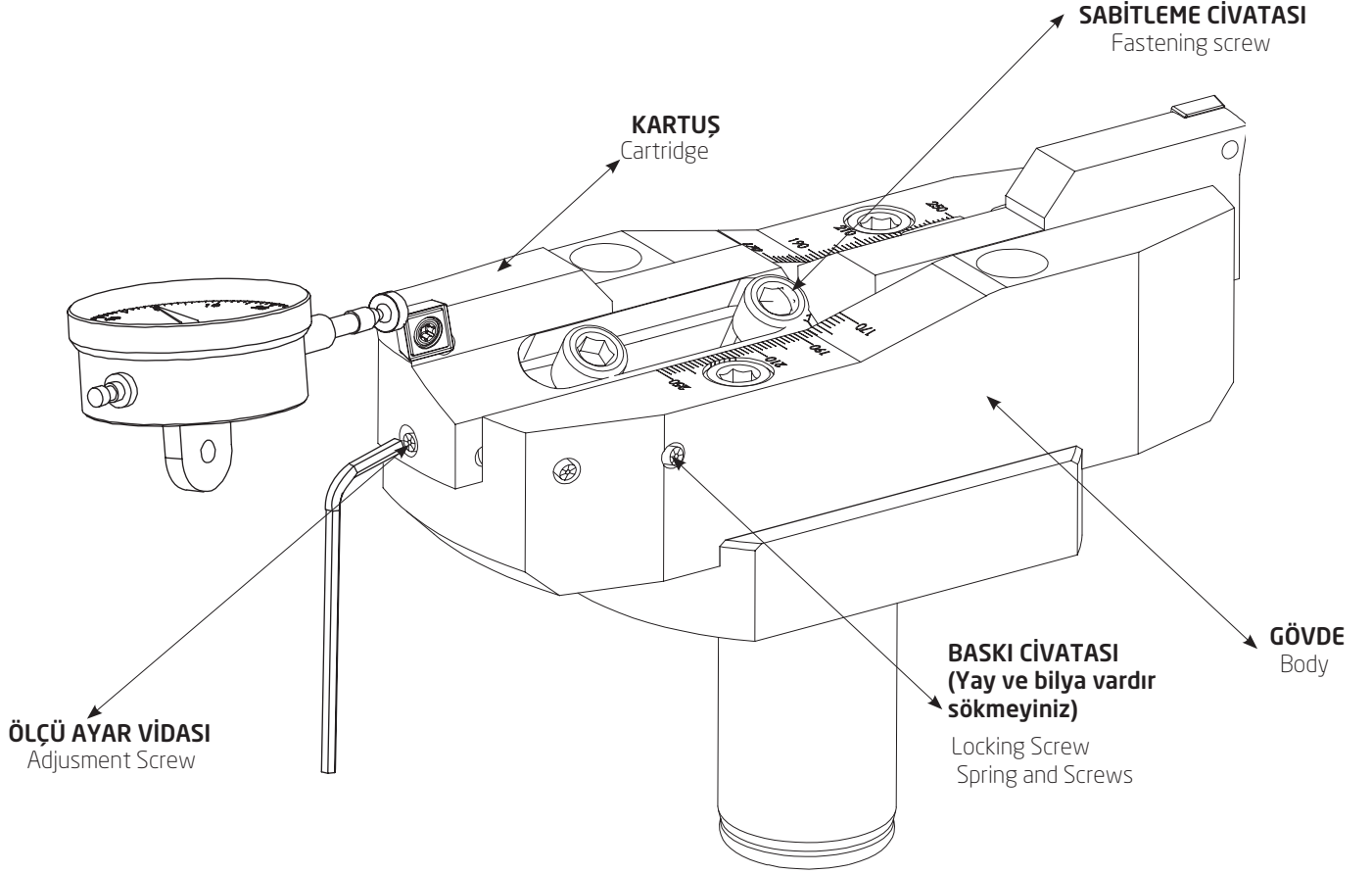

Dmin-Dmax	Kartuşlar Cartridges Kartusche	Kullanılan Uç Insert WSP	Sıkma Cıvatası Clamp Screw Torx-Schraube	Sabitleme Cıvatası Locking Screw Verriegelungs Schraube	Ayar Cıvatası Adjustment Screw Einstellschraube	Anahtar Torx Key Torx-Schlüssel
120-170	KR119	CCMT 1204	TC083 M5x12	TC109-M8x25	SK42-M6x20	T20
170-250	KR120		TC083 M5x12	TC109-M8x25	SK43-M6x30	T20
240-350	KR124		TC083 M5x12	TC109-M8x25	SK44-M6x40	T20

BORING CUTTING

T O O L S

120mm-300mm



SCAN NOW

teknikcuttingtools.com



Helis ve Disk Frezeler
Shoulder Milling & Disc Milling
İgelfräser & Scheibenfräsen



**Technical Solution
for Quality**



APKT 1604

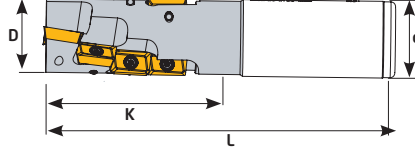
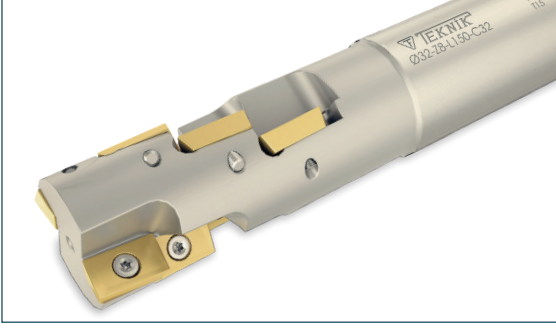

Ölçüler (mm) Dimensions(mm) Abmessungen (mm)		APKT 1604	
L	s		
16,4	4,76		

Sipariş Kodu Order Code Best.-Nr.	Stok/Stock/Lager	Ürün Kodu Product Code Produkt-Code	Ölçüler (mm) Dimensions(mm) Abmessungen (mm)						Uç Insert WSP	Sıkma Civatası Clamp Screw Torx-Schraube	Anahtar Torx Key Torx-Schlüssel
			D	Z	K	d	L	☺			
HF20	●	D32 Z06 K43 APKT 16	32	6	43	32	125	0,658	APKT1604 KRLY	TC074 M4x10	T15
HF22	●	D40 Z09 K43 APKT 16	40	9	43	32	125	0,821			
HF24	●	D32 Z08 K58 APKT 16	32	8	58	32	150	0,771			
HF26	●	D40 Z12 K58 APKT 16	40	12	58	32	150	0,950			
HF30	●	D32 Z08 K58 APKT 16	32	8	58	32	200	1,120			
HF32	●	D40 Z12 K58 APKT 16	40	12	58	32	200	1,280			

KRLY ucuna uygundur. / Compatible with KRLY insert. / Kompatibel für KRLY WP

APXT 1003

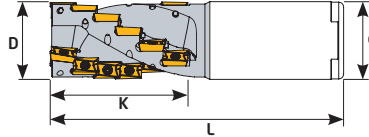
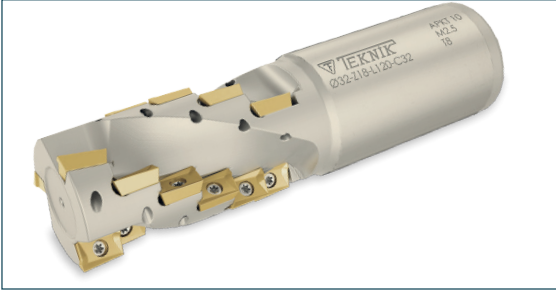

Ölçüler (mm) Dimensions(mm) Abmessungen (mm)		APXT 1003	
L	s		
10,5	3,52		

Sipariş Kodu Order Code Best.-Nr.	Stok/Stock/Lager	Ürün Kodu Product Code Produkt-Code	Ölçüler (mm) Dimensions(mm) Abmessungen (mm)						Uç Insert WSP	Sıkma Civatası Clamp Screw Torx-Schraube	Anahtar Torx Key Torx-Schlüssel
			D	Z	K	d	L	☺			
HF06	●	D20 Z06 K28 APXT 10	20	6	28	20	120	0,265	APXT1003 KRLY	TC060 M2,5x5,5	T8
HF07	●	D25 Z08 K37 APXT 10	25	8	37	25	120	0,404			
HF08	●	D32 Z15 K46 APXT 10	32	15	46	32	120	0,627			
HF09	●	D40 Z18 K55 APXT 10	40	18	55	32	125	0,873			
HF10	●	D20 Z06 K28 APXT 10	20	6	28	20	150	0,326			
HF11	●	D25 Z08 K37 APXT 10	25	8	37	25	150	0,515			
HF12	●	D32 Z15 K46 APXT 10	32	15	46	32	150	1,120			
HF13	●	D40 Z18 K55 APXT 10	40	18	55	32	150	1,100			
HF15	●	D20 Z06 K28 APKT 10	20	6	28	20	200	0,481			
HF16	●	D25 Z08 K37 APXT 10	25	8	37	25	200	0,727			
HF17	●	D32 Z15 K46 APXT 10	32	15	46	32	200	1,144			
HF18	●	D40 Z18 K55 APXT 10	40	18	55	32	200	1,621			

KRLY ucuna uygundur. / Compatible with KRLY insert. / Kompatibel für KRLY WP

● Stokta/In Stock/Lager ○ Sınırlı Stok/Limited Stock/Begrenzte Lagerhaltung



APKT 1604

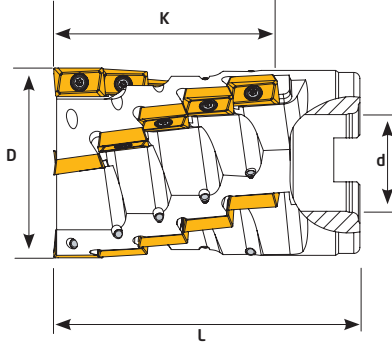

Ölçüler (mm) Dimensions(mm) Abmessungen (mm)		APKT 1604	
L	s		
16,4	4,76		

Sipariş Kodu Order Code Best.-Nr.	Stok/Stock/Lager	Ürün Kodu Product Code Produkt-Code	Ölçüler (mm) Dimensions(mm) Abmessungen (mm)						Uç Insert WSP	Sıkma Cıvatası Clamp Screw Torx-Schraube	Anahtar Torx Key Torx-Schlüssel
			D	Z	K	d	L				
HF52	●	D063 Z20 K75 APKT 16	63	20	75	32	100	1,455	APKT 1604 KRLY	TC074 M4x10	T15
HF53	●	D080 Z25 K75 APKT 16	80	25	75	32	100	2,645			
HF54	○	D100 Z30 K75 APKT 16	100	30	75	40	100	4,329			

KRLY ucuna uygundur. / Compatible with KRLY insert. / Kompatibel für KRLY WP

SCMT 09T3-1204

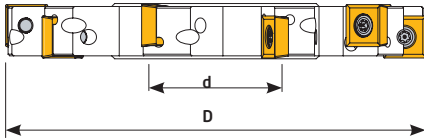
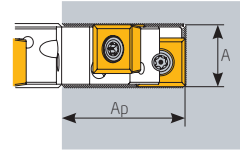

Ölçüler (mm) Dimensions(mm) Abmessungen (mm)		SCMT 1204	
L	s		
12,7	4,97		
9,52	3,97		

Sipariş Kodu Order Code Best.-Nr.	Stok/Stock/Lager	Ürün Kodu Product Code Produkt-Code	Ölçüler (mm) Dimensions(mm) Abmessungen (mm)						Uç Insert WSP	Sıkma Cıvatası Clamp Screw Torx-Schraube	Anahtar Torx Key Torx-Schlüssel
			D	A	Z	d	Ap				
DF086	●	D080 A10 Z08 SCMT 09	80	10	8	27	17	0,229	SCMT 09T3 ISO	TC074 M4x10	T15
DF092	●	D100 A10 Z08 SCMT 09	100	10	8	32	24	0,408			
DF100	●	D125 A10 Z10 SCMT 09	125	10	10	40	32	0,612			
DF108	●	D160 A10 Z12 SCMT 09	160	10	12	40	50	1,280			
DF116	●	D200 A10 Z14 SCMT 09	200	10	14	40	65	1,738			
DF088	●	D080 A12 Z08 SCMT 09	80	12	8	27	17	0,445			
DF094	●	D100 A12 Z08 SCMT 09	100	12	8	32	24	0,477			
DF102	●	D125 A12 Z10 SCMT 09	125	12	10	40	32	0,748			
DF110	●	D160 A12 Z12 SCMT 09	160	12	12	40	50	1,313			
DF118	●	D200 A12 Z14 SCMT 09	200	12	14	40	65	2,140			
DF090	●	D080 A16 Z08 SCMT 12	80	16	8	27	17	0,564			
DF096	●	D100 A16 Z08 SCMT 12	100	16	8	32	24	0,353			
DF104	●	D125 A16 Z10 SCMT 12	125	16	10	40	32	0,927			
DF112	●	D160 A16 Z12 SCMT 12	160	16	12	40	50	1,634			
DF120	●	D200 A16 Z14 SCMT 12	200	16	14	40	65	2,769			
DF106	●	D125 A20 Z10 SCMT 12	125	20	10	40	32	1,167			
DF114	●	D160 A20 Z12 SCMT 12	160	20	12	40	50	2,145			

● Stokta/ In Stock/ Lager ○ Sınırlı Stok/ Limited Stock/ Begrenzte Lagerhaltung

CCMT 0602-09T3-1204

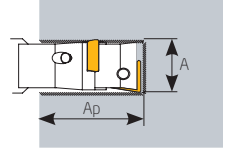
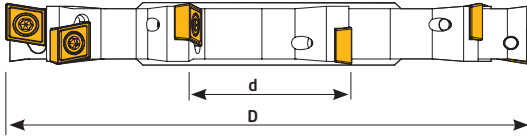
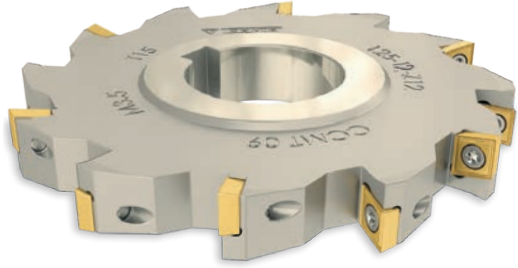

Ölçüler (mm) Dimensions(mm) Abmessungen (mm)		CCMT 0602	CCMT 1204
L	s		
6,2	2,38		
9,4	3,97		
12,4	4,76		

Sipariş Kodu Order Code Best.-Nr.	Stok/Stok/Lager	Ürün Kodu Product Code Produkt-Code	Ölçüler (mm) Dimensions(mm) Abmessungen (mm)						Uç Insert WSP	Sıkma Cıvatası Clamp Screw Torx-Schraube	Anahtar Torx Key Torx-Schlüssel
			D	A	Z	d	Ap				
DF150	●	D080 A08 Z10 CCMT 06	80	8	10	27	16	0,236	CCMT 0602 ISO	TC063 M2,5x7	T8
DF160	●	D100 A08 Z12 CCMT 06	100	8	12	32	24	0,365			
DF170	●	D125 A08 Z14 CCMT 06	125	8	14	40	32	0,512			
DF182	●	D160 A08 Z16 CCMT 06	160	8	16	40	50	0,996			
DF194	●	D200 A08 Z18 CCMT 06	200	8	18	40	70	1,587			
DF152	●	D080 A10 Z10 CCMT 06	80	10	10	27	16	0,289			
DF162	●	D100 A10 Z12 CCMT 06	100	10	12	32	24	0,453			
DF172	●	D125 A10 Z14 CCMT 06	125	10	14	40	32	0,703			
DF184	●	D160 A10 Z16 CCMT 06	160	10	16	40	50	1,228			
DF196	●	D200 A10 Z18 CCMT 06	200	10	18	40	70	2,035			
DF154	●	D080 A12 Z08 CCMT 09	80	12	8	27	16	0,470	CCMT 09T3 ISO	TC067 M3,5x9	T15
DF164	●	D100 A12 Z10 CCMT 09	100	12	10	32	24	0,472			
DF174	●	D125 A12 Z12 CCMT 09	125	12	12	40	32	0,750			
DF186	●	D160 A12 Z14 CCMT 09	160	12	14	40	50	1,360			
DF198	●	D200 A12 Z16 CCMT 09	200	12	16	40	70	2,400			
DF156	●	D080 A14 Z08 CCMT 09	80	14	8	27	16	0,335			
DF166	●	D100 A14 Z10 CCMT 09	100	14	10	32	24	0,552			
DF176	●	D125 A14 Z12 CCMT 09	125	14	12	40	32	0,871			
DF188	●	D160 A14 Z14 CCMT 09	160	14	14	40	50	1,535			
DF200	●	D200 A14 Z16 CCMT 09	200	14	16	40	70	2,575			
DF158	●	D080 A16 Z06 CCMT 12	80	16	6	27	16	0,545	CCMT 1204 ISO	TC083 M5x12	T20
DF168	●	D100 A16 Z08 CCMT 12	100	16	8	32	24	0,567			
DF178	●	D125 A16 Z10 CCMT 12	125	16	10	40	32	1,121			
DF190	●	D160 A16 Z12 CCMT 12	160	16	12	40	50	1,727			
DF180	●	D125 A20 Z10 CCMT 12	125	20	10	40	32	1,430			
DF192	●	D160 A20 Z12 CCMT 12	160	20	12	40	50	2,650			

● Stokta/In Stock/Lager ○ Sınırlı Stok/Limited Stock/Begrenzte Lagerhaltung



T Kanal Freze
T-Slot Milling Cutter
T- Nutenfräser



**Technical Solution
for Quality**



CCMT 0602-09T3-1204

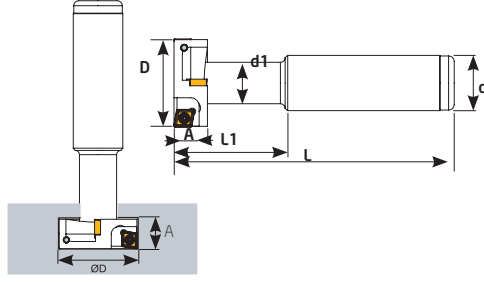

Ölçüler (mm) Dimensions(mm) Abmessungen (mm)		CCMT 0602	CCMT 1204
L	s		
6,2	2,38		
9,4	3,97		
12,4	4,76		

Sipariş Kodu Order Code Best.-Nr.	Stok/Stock/Lager	Ürün Kodu Product Code Produkt-Code	Ölçüler (mm) Dimensions(mm) Abmessungen (mm)									Kullanılan Uç Insert WSP	Sıkma Cıvatası Clamp Screw Torx-Schraube	Anahtar Torx Key Torx-Schlüssel
			D	A	Z	d	d1	L	L1					
TKÇ096	●	D17 A08 Z02 CCMT 06	17	8	2	16	10	100	28	0,145	CCMT 0602 ISO	TC060 M2,5x5,5	T8	
TKÇ098	●	D21 A09 Z02 CCMT 06	21	9	2	16	11	100	31,5	0,151				
TKÇ100	●	D25 A11 Z04 CCMT 06	25	11	4	20	15	100	32,5	1,232				
TKÇ102	●	D32 A12 Z04 CCMT 06	32	12	4	20	15	100	40	0,300				
TKÇ103	●	D32 A14 Z04 CCMT 09	32	14	4	25	16	100	33	0,434	CCMT 09T3 ISO	TC067 M3,5x9	T15	
TKÇ104	●	D35 A15 Z04 CCMT 09	35	15	4	25	14	100	52	0,447				
TKÇ106	●	D40 A17 Z04 CCMT 09	40	17	4	25	20	110	50	0,509				
TKÇ108	●	D50 A20 Z04 CCMT 12	50	20	4	32	26	110	50	0,691	CCMT 1204 ISO	TC083 M5x12	T20	
TKÇ120	●	D63 A09 Z08 CCMT 06	63	9	8	32	19,5	125	37	0,842	CCMT 0602 ISO	TC060 M2,5x5,5	T8	
TKÇ122	●	D80 A09 Z10 CCMT 06	80	9	10	32	31,5	120	32	1,025				

CCMT 0602-09T3-1204 ISO'dur./ CCMT 0602-09T3-1204 is ISO./ Kompatible für ISO WP

SPMG 05-06-07

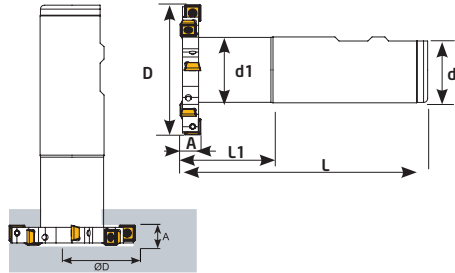

Ölçüler (mm) Dimensions(mm) Abmessungen (mm)		SPMG 0502	SPMG 07T3
L	s		
5	2,38		
6	3,97		
7,94	3,97		

Sipariş Kodu Order Code Best.-Nr.	Stok/Stock/Lager	Ürün Kodu Product Code Produkt-Code	Ölçüler (mm) Dimensions(mm) Abmessungen (mm)									Kullanılan Uç Insert WSP	Sıkma Cıvatası Clamp Screw Torx-Schraube	Anahtar Torx Key Torx-Schlüssel
			D	A	Z	d	d1	L	L1					
TKÇ050	●	D50 A05 Z07 SPMG 05	50	5	7	32	31,5	120	45	0,830	SPMG 05 TGTC	TC058 M2x4,2	T6	
TKÇ052	●	D63 A05 Z08 SPMG 05	63	5	8	32	31,5	120	45	0,861				
TKÇ054	●	D50 A06 Z07 SPMG 06	50	6	7	32	31,5	120	45	0,833	SPMG 06 TGTC	TC059 M2,2x5	T7	
TKÇ056	●	D63 A06 Z08 SPMG 06	63	6	8	32	31,5	120	45	0,850				
TKÇ058	●	D80 A06 Z10 SPMG 06	80	6	10	32	31,5	120	45	0,944				
TKÇ060	●	D50 A08 Z06 SPMG 06	50	8	6	32	31,5	120	45	0,839				
TKÇ062	●	D63 A08 Z08 SPMG 06	63	8	8	32	31,5	120	45	0,874	SPMG 07 TGTC	TC063 M2,5x7	T8	
TKÇ064	●	D80 A08 Z10 SPMG 06	80	8	10	32	31,5	120	45	0,995				
TKÇ066	●	D50 A10 Z06 SPMG 07	50	10	6	32	31,5	120	45	0,496				
TKÇ068	●	D63 A10 Z08 SPMG 07	63	10	8	32	31,5	120	45	0,868				
TKÇ070	●	D80 A10 Z10 SPMG 07	80	10	10	32	31,5	120	45	0,994				

TGTC ucuna uygundur./ Compatible with TGTC insert./ Kompatible für TGTC WP



DAİRE KANAL TAKIMI /Round Milling Cutter

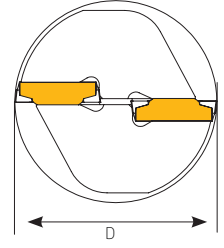
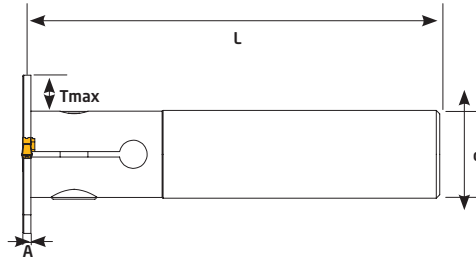

Sipariş Kodu Order Code Best.-Nr.	Stok/Stock/Lager	Ürün Kodu Product Code Produkt-Code	Ölçüler (mm) Dimensions(mm) Abmessungen (mm)							Kullanılan Uç Insert WSP	Sıkma Civatası Clamp Screw Torx-Schraube	Anahtar Torx Key Torx-Schlüssel
			D	A	Z	L	d	Tmax	kg			
TKÇ300	●	D50 A03 Z02 L-120	50	3	2	120	25	12,75	0,498	MGM 3C KRLY	TC136 M8x20	6 Allen
TKÇ301	●	D63 A03 Z02 L-120	63	3	2	120	25	19,25	0,543			
TKÇ302	●	D80 A03 Z02 L-120	80	3	2	120	32	24,25	0,841			
TKÇ303	●	D50 A04 Z02 L-120	50	4	2	120	25	12,75	0,536	MGM 4C KRLY	TC136 M8x20	6 Allen
TKÇ304	●	D63 A04 Z02 L-120	63	4	2	120	25	19,25	0,556			
TKÇ305	●	D80 A04 Z02 L-120	80	4	2	120	32	24,25	0,860			
TKÇ306	●	D55 A05 Z02 L-120	55	5	2	120	25	15,25	0,513	MGM 5C KRLY	TC136 M8x20	6 Allen
TKÇ307	●	D63 A05 Z02 L-120	63	5	2	120	25	19,25	0,529			
TKÇ308	●	D80 A05 Z02 L-120	80	5	2	120	32	24,25	0,860			

KRLY ucuna uygundur. / Compatible with KRLY insert. / Kompatibel für KRLY WP

TCMT 1102 16T3 HAVŞA / Chamfer End Mills

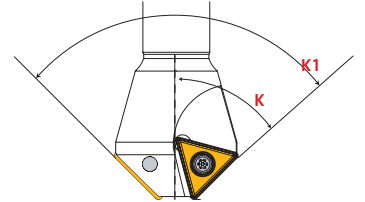
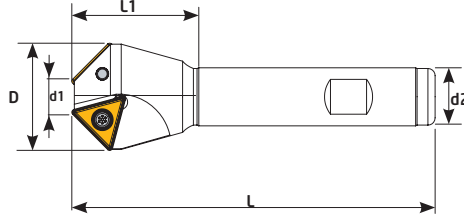
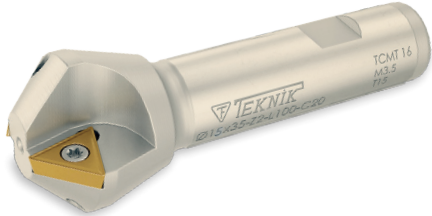

Sipariş Kodu Order Code Best.-Nr.	Stok/Stock/Lager	Ürün Kodu Product Code Produkt-Code	Ölçüler (mm) Dimensions(mm) Abmessungen (mm)									Kullanılan Uç Insert WSP	Sıkma Civatası Clamp Screw Torx-Schraube	Anahtar Torx Key Torx-Schlüssel
			K	K1	d1	D	Z	d2	L	L1	kg			
S337	●	06-20 Z01 K30° TCMT 16	30°	60°	6	20	1	16	100	37	0,170	TCMT 16T3 ISO	TC067 M3,5x8,5	T15
S345	●	10-34 Z02 K30° TCMT 16	30°	60°	10	34	2	20	100	40	0,307			
S343	●	24-39 Z02 K30° TCMT 16	30°	60°	24	39	2	20	100	36	0,356			
S334	●	04-16 Z01 K45° TCMT 11	45°	90°	4	16	1	16	100	35	0,140	TCMT 1102 ISO	TC060 M2,5x5,5	T8
S341	●	06-24 Z01 K45° TCMT 16	45°	90°	6	24	1	20	100	30	0,256			
S336	●	10-31 Z02 K45° TCMT 16	45°	90°	10	31	2	16	100	35	0,204			
S338	●	14-35 Z02 K45° TCMT 16	45°	90°	14	35	2	20	100	35	0,324	TCMT 16T3 ISO	TC067 M3,5x8,5	T15
S340	●	22-43 Z03 K45° TCMT 16	45°	90°	22	43	3	25	100	37	0,634			
S342	●	32-53 Z03 K45° TCMT 16	45°	90°	32	53	3	25	100	37	0,634			
S335	●	02-18 Z01 K60° TCMT 11	60°	120°	2	18	1	16	100	35	0,157	TCMT 1102 ISO	TC060 M2,5x5,5	T8
S339	●	10-31 Z02 K60° TCMT 16	60°	120°	10	31	2	16	100	35	0,213			

● Stokta/ In Stock/ Lager ○ Sınırlı Stok/ Limited Stock/ Begrenzte Lagerhaltung

Kalite için Teknik Çözüm | Technical Solution For Quality



www.teknikcuttingtools.com

Açılı Havşa Takımı /Angled Chamfer Mill



Derecesi ayarlanabilir havşa freze
Adjustable angle chamfering mill

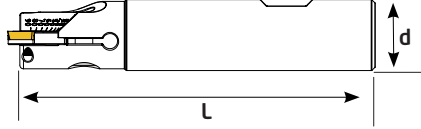
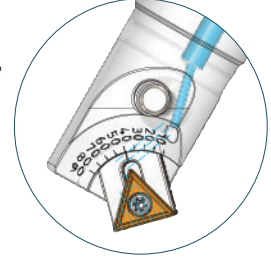

Sipariş Kodu Order Code Best.-Nr.	Stok/Stock/Lager	Ürün Kodu Product Code Produkt-Code	Ölçüler (mm) Dimensions(mm) Abmessungen (mm)						Insert	Fleximill	Clamp Screw	Fleximill Screw	Torx Key
			D min	D max	d	L	Y°	kg					
AH10	●	D020-R1 L100	5	27	20	100	10-80	0,241	TCMT 11	AH20	TC063 M2,5x7	M5x12	T8
AH15	●	D025-R1 L100	5	34	25	100	10-80	0,370	TCMT 16	AH21	TC067M3,5x8,5	M6x15	T15

TWX 16R

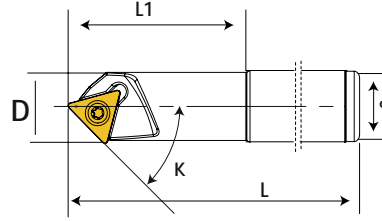

Sipariş Kodu Order Code Best.-Nr.	Ürün Kodu Product Code Produkt-Code	K	D	Z	L	d	L1	kg	Insert	Clamp Screw	Torx Key
S352	● D21 d20 Z01 L110 TWX 16	45°	21	1	110	20	50	0,260	TWX 16R KRLY	TC072 M4x10	T15

KRLY ucuna uygundur. / Compatible with KRLY insert. / Kompatible für KRLY WP

SOMT 11T3

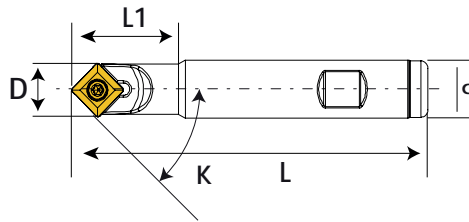

Sipariş Kodu Order Code Best.-Nr.	Ürün Kodu Product Code Produkt-Code	K	D	Z	L	d	L1	kg	Insert	Clamp Screw	Torx Key
S769	○ D16 d16 Z01 L100 SOMT 11	45°	16	1	100	16	32	0,153	SOMT 11T3 PLBT	TC067 M3,5x8,5	T15
S770	○ D16 d16 Z01 L150 SOMT 11	45°	16	1	150	16	32	0,238	SOMT 11T3 PLBT	TC067 M3,5x8,5	T15

PLBT ucuna uygundur. / Compatible with PLBT insert. / Kompatible für PLBT WP



Arka Yüzey Frezeleme

Back Facing Milling Cutters

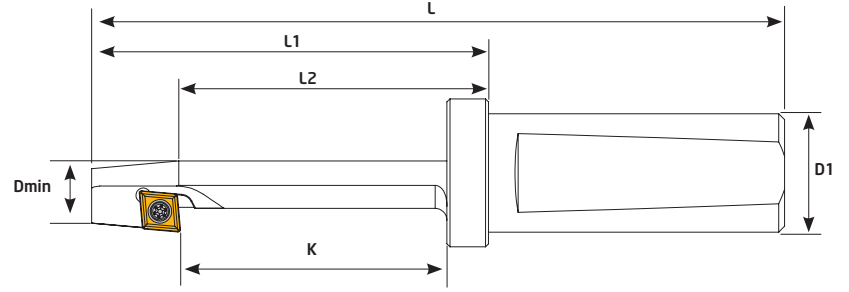

Sipariş Kodu Order Code Best.-Nr.	Stok/Stok/Lager	Ürün Kodu Product Code Produkt-Code	Ölçüler (mm) Dimensions(mm) Abmessungen (mm)								Kullanılan Uç Insert WSP	Sıkma Civatası Clamp Screw Torx-Schraube	Anahtar Torx Key Torx-Schlüssel
			D	Dmin	K	L	L1	L2	D1	kg			
C100	●	D18-K40 CCMT 06	18	10	40	110	60	47	20	0,194	CCMT 060204 ISO	TC060 M2,5x5	T8
C102	●	D20-K45 CCMT 06	20	12	45	117	67	52	20	0,210			
C104	●	D26-K60 CCMT 06	26	17	60	132	82	67	20	0,261			
C106	●	D33-K75 CCMT 09	33	21	75	152	102	82	20	0,308	CCMT 09T304 ISO	TC067 M3,5x8,5	T15

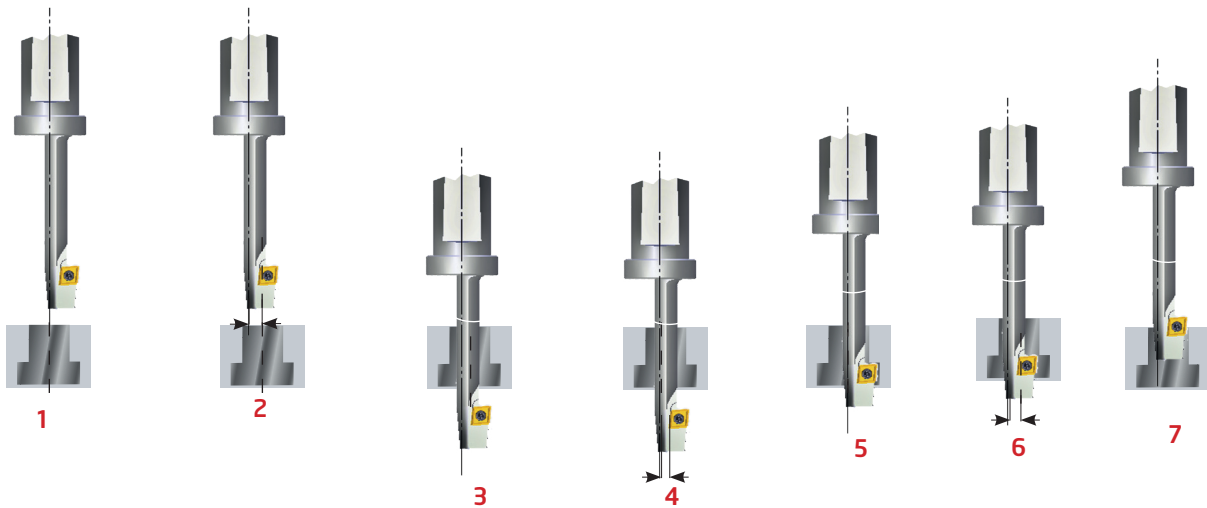

● Stokta/In Stock/Lager ○ Sınırlı Stok/Limited Stock/Begrenzte Lagerhaltung

Kalite için Teknik Çözüm | Technical Solution For Quality

BROTECH

TEKNİK
Cutting Tools

www.teknikcuttingtools.com

RHKW 1003

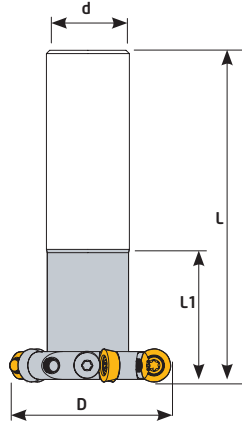

Ölçüler (mm) Dimensions(mm) Abmessungen (mm)		RHKW 1003	
d	S		
10	3,80		

Sipariş Kodu Order Code Best.-Nr.	Stok/Stock/Lager	Ürün Kodu Product Code Produkt-Code	Ölçüler (mm) Dimensions(mm) Abmessungen (mm)						Kullanılan Uç Insert WSP	Civata Torx- Schraube	Baskı Civatası Locking Screw Verriegelungs Schraube	Anahtar Torx Key Torx-Schlüssel
			D	Z	L	d	L1					
TKÇ200	○	D40 d20 Z04 L100 RHKW 10	40	4	100	20	40	0,285	RHKW 1003 INGRSLL	TC074 M4x10	TC040 M3,5	T15
TKÇ202	○	D50 d25 Z05 L120 RHKW 10	50	5	120	25	40	0,284				

INGRSLL ucuna uygundur. / Compatible with INGRSLL insert. / Kompatible für INGRSLL WP

45° SPMG 0904

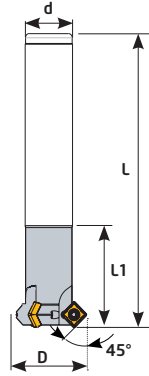

Ölçüler (mm) Dimensions(mm) Abmessungen (mm)		SPMG 0904	
d	S		
9,8	4,3		

Sipariş Kodu Order Code Best.-Nr.	Stok/Stock/Lager	Ürün Kodu Product Code Produkt-Code	Ölçüler (mm) Dimensions(mm) Abmessungen (mm)						Kullanılan Uç Insert WSP	Sıkma Civatası Clamp Screw Torx-Schraube	Anahtar Torx Key Torx-Schlüssel
			D	Z	L	d	L1				
S060	●	D32 d25 Z02 L150 SPMG 09	32	2	150	25	30	0,589	SPMG 0904 TGTC	TC067 M3,5x8,5	T15
S062	●	D40 d25 Z03 L150 SPMG 09	40	3	150	25	50	0,562			

TGTC ucuna uygundur. / Compatible with TGTC insert. / Kompatible für TGTC WP



55° DCMT 11T3-35° VBMT 1604

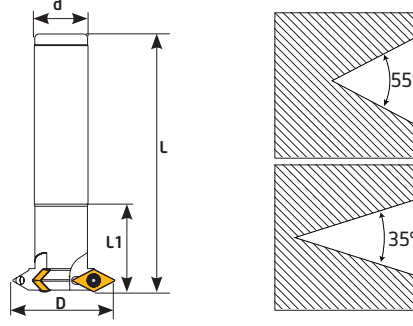

Ölçüler (mm) Dimensions(mm) Abmessungen (mm)		DCMT 11T3	
L	s		
11,3	3,97		
15,3	4,76		
Ölçüler (mm) Dimensions(mm) Abmessungen (mm)		VBMT 1604	
L	s		
11,3	3,97		
15,3	4,76		

Sipariş Kodu Order Code Best.-Nr.	Stok/Stock/Lager	Ürün Kodu Product Code Produkt-Code	Ölçüler (mm) Dimensions(mm) Abmessungen (mm)						Kullanılan Uç Insert w/SP	Sıkma Civatası Clamp Screw Torx-Schraube	Anahtar Torx Key Torx-Schlüssel
			D	Z	L	d	L1				
S070	●	D50 d25 Z03 L120 DCMT 11	50	3	120	25	40	0,584			
S072	●	D63 d25 Z04 L120 DCMT 11	63	4	120	25	40	0,536	DCMT 11T3 ISO	TC067 M3.5X9	T15
S073	●	D75 d25 Z03 L130 VBMT 16	75	3	130	25	40	0,924	VBMT 1604 ISO	TC074 M4x10	

55° DCMT 11T3

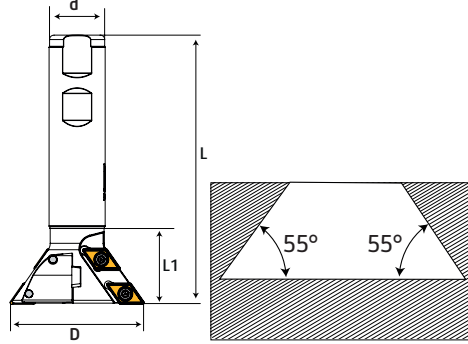

Ölçüler (mm) Dimensions(mm) Abmessungen (mm)		DCMT 11T3	
L	s		
11,3	3,97		

Sipariş Kodu Order Code Best.-Nr.	Stok/Stock/Lager	Ürün Kodu Product Code Produkt-Code	Ölçüler (mm) Dimensions(mm) Abmessungen (mm)						Kullanılan Uç Insert w/SP	Sıkma Civatası Clamp Screw Torx-Schraube	Anahtar Torx Key Torx-Schlüssel
			D	Z	L	d	L1				
TKÇ251	●	D60 d25 Z04 L120 DCMT 11	60	4	120	25	35	0,583	DCMT 11T3 ISO	TC067 M3.5X9	T15

60° DCMT 11T3

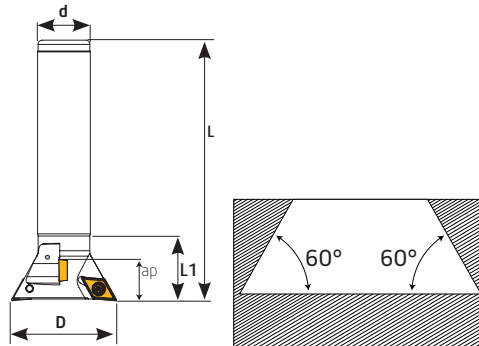

Ölçüler (mm) Dimensions(mm) Abmessungen (mm)		DCMT 11T3	
L	s		
11,3	3,97		

Sipariş Kodu Order Code Best.-Nr.	Stok/Stock/Lager	Ürün Kodu Product Code Produkt-Code	Ölçüler (mm) Dimensions(mm) Abmessungen (mm)							Kullanılan Uç Insert w/SP	Sıkma Civatası Clamp Screw Torx-Schraube	Anahtar Torx Key Torx-Schlüssel
			D	Z	L	d	L1	ap				
TKÇ250	●	D50 d25 Z04 L120 DCMT 11	50	4	120	25	30	18	0,521	DCMT 11T3 ISO	TC067 M3.5X9	T15

● Stokta/In Stock/Lager ○ Sınırlı Stok/Limited Stock/Begrenzte Lagerhaltung

Kalite için Teknik Çözüm | Technical Solution For Quality



www.teknikcuttingtools.com



Kalite için TEKNİK çözüm
Technical solution for quality



www.teknikcuttingtools.com



Saplı Tarama
End Mill
Schafffräser



**Technical Solution
for Quality**



Technical Solution For Quality | teknikcuttingtools.com

APXT 1003

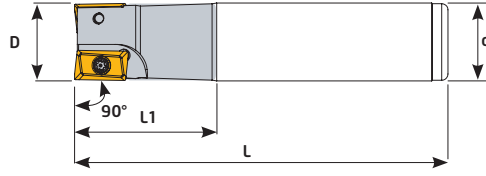
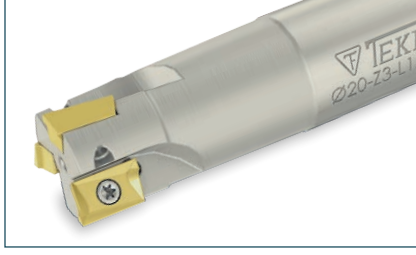

Ölçüler (mm) Dimensions(mm) Abmessungen (mm)		APXT 1003	
L	s		
10,5	3,52		

Sipariş Kodu Order Code Best.-Nr.	Stok / Stock / Lager	Ürün Kodu Product Code Produkt-Code	Ölçüler (mm) Dimensions(mm) Abmessungen (mm)						Sıkma Civatası Clamp Screw Torx-Schraube	Kullanılan Uç Insert WSP	Anahtar Torx Key Torx-Schlüssel
			D	Z	L	d	L1	kg			
S136	●	D12 d12 Z01 L100 APXT 10	12	1	100	12	27	0,097			
S138	●	D14 d14 Z01 L100 APXT 10	14	1	100	14	30	0,126			
S140	●	D16 d16 Z02 L100 APXT 10	16	2	100	16	30	0,156			
S142	●	D18 d16 Z02 L100 APXT 10	18	2	100	16	30	0,162			
S144	●	D20 d20 Z03 L100 APXT 10	20	3	100	20	30	0,231			
S146	●	D22 d20 Z03 L100 APXT 10	22	3	100	20	30	0,243			
S148	●	D25 d25 Z03 L100 APXT 10	25	3	100	25	35	0,365			
S150	●	D30 d25 Z04 L100 APXT 10	30	4	100	25	40	0,400			
S152	●	D32 d25 Z04 L100 APXT 10	32	4	100	25	35	0,415			
S154	●	D35 d25 Z04 L100 APXT 10	35	4	100	25	30	0,452			
S156	●	D40 d25 Z05 L100 APXT 10	40	5	100	25	30	0,477			
S158	●	D12 d12 Z01 L120 APXT 10	12	1	120	12	27	0,112			
S160	●	D14 d14 Z01 L120 APXT 10	14	1	120	14	30	0,150			
S162	●	D16 d16 Z02 L120 APXT 10	16	2	120	16	40	0,185			
S164	●	D18 d16 Z02 L120 APXT 10	18	2	120	16	45	0,190			
S166	●	D20 d20 Z03 L120 APXT 10	20	3	120	20	40	0,278			
S168	●	D22 d20 Z03 L120 APXT 10	22	3	120	20	40	0,290			
S169	●	D25 d25 Z03 L120 APXT 10	25	3	120	25	40	0,452			
S170	●	D30 d25 Z04 L120 APXT 10	30	4	120	25	40	0,487	TC060 M2,5x5,5	APXT 1003	T8
S171-1	●	D32 d25 Z04 L120 APXT 10	32	4	120	25	40	0,511		KRLY	
S171	●	D35 d25 Z04 L120 APXT 10	35	4	120	25	40	0,532			
S172	●	D40 d25 Z05 L120 APXT 10	40	5	120	25	40	0,606			
S173	●	D16 d16 Z02 L150 APXT 10	16	2	150	16	50	0,230			
S174	●	D18 d16 Z02 L150 APXT 10	18	2	150	16	50	0,246			
S176	●	D20 d20 Z03 L150 APXT 10	20	3	150	20	60	0,345			
S178	●	D22 d20 Z03 L150 APXT 10	22	3	150	20	60	0,360			
S180	●	D25 d25 Z03 L150 APXT 10	25	3	150	25	60	0,563			
S180-1	●	D30 d25 Z04 L150 APXT 10	30	4	150	25	60	0,610			
S181	●	D32 d32 Z04 L150 APXT 10	32	4	150	32	45	0,916			
S182	●	D16 d16 Z02 L200 APXT 10	16	2	200	16	60	0,480			
S184	●	D18 d16 Z02 L200 APXT 10	18	2	200	16	60	0,350			
S186	●	D20 d20 Z03 L200 APXT 10	20	3	200	20	70	0,500			
S187	●	D22 d20 Z03 L200 APXT 10	22	3	200	20	70	0,513			
S188	●	D25 d25 Z03 L200 APXT 10	25	3	200	25	60	0,771			
S188-1	●	D30 d25 Z04 L200 APXT 10	30	4	200	25	50	0,845			
S189	●	D32 d32 Z04 L200 APXT 10	32	4	200	32	60	1,253			
S190	●	D16 d16 Z02 L250 APXT 10	16	2	250	16	70	0,415			
S192	●	D20 d20 Z03 L250 APXT 10	20	3	250	20	70	0,623			
S194	●	D25 d25 Z03 L250 APXT 10	25	3	250	25	70	0,953			

KRLY ucuna uygundur. / Compatible with KRLY insert. / Kompatibel für KRLY WP

● Stokta / In Stock / Lager ○ Sınırlı Stok / Limited Stock / Begrenzte Lagerhaltung



APKT 1604

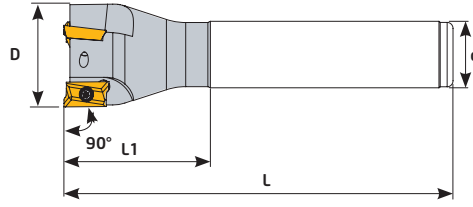
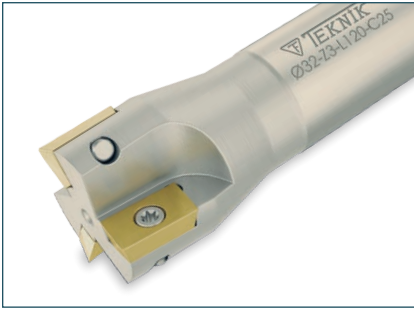

Ölçüler (mm) Dimensions(mm) Abmessungen (mm)		APKT 1604	
L	s		
16,4	4,76		

Sipariş Kodu Order Code Best.-Nr.	Stok/Stock/Lager	Ürün Kodu Product Code Produkt-Code	Ölçüler (mm) Dimensions(mm) Abmessungen (mm)						Sıkma Cıvatası Clamp Screw Torx-Schraube	Kullanılan Uç Insert WSP	Anahtar Torx Key Torx-Schlüssel
			D	Z	L	d	L1	kg			
S256	●	D25 d25 Z02 L120 APKT 16	25	2	120	25	45	0,430			
S258	●	D30 d25 Z03 L120 APKT 16	30	3	120	25	45	0,460			
S260	●	D32 d25 Z03 L120 APKT 16	32	3	120	25	45	0,469			
S262	●	D35 d25 Z03 L120 APKT 16	35	3	120	25	45	0,498			
S264	●	D40 d25 Z04 L120 APKT 16	40	4	120	25	45	0,547			
S266	●	D25 d25 Z02 L150 APKT 16	25	2	150	25	55	0,544			
S268	●	D30 d25 Z03 L150 APKT 16	30	3	150	25	55	0,575			
S270	●	D32 d32 Z03 L150 APKT 16	32	3	150	32	55	0,876			
S272	●	D35 d32 Z03 L150 APKT 16	35	3	150	32	55	0,915			
S274	●	D40 d32 Z04 L150 APKT 16	40	4	150	32	55	0,960			
S276	●	D25 d25 Z02 L200 APKT 16	25	2	200	25	65	0,750			
S278	●	D30 d25 Z03 L200 APKT 16	30	3	200	25	55	0,783			
S280	●	D32 d32 Z03 L200 APKT 16	32	3	200	32	55	1,218	TC074	APKT 1604	T15
S282	●	D35 d32 Z03 L200 APKT 16	35	3	200	32	55	1,245	M4x10	KRLY	
S283	●	D40 d32 Z04 L200 APKT 16	40	4	200	32	55	1,296			
S432	●	D25 d25 Z02 L250 APKT 16	25	2	250	25	70	0,939			
S434	●	D30 d25 Z03 L250 APKT 16	30	3	250	25	55	1,028			
S436	●	D32 d32 Z03 L250 APKT 16	32	3	250	32	60	1,520			
S438	●	D35 d32 Z03 L250 APKT 16	35	3	250	32	65	1,567			
S440	●	D40 d32 Z04 L250 APKT 16	40	4	250	32	60	1,612			
S442	●	D25 d25 Z02 L300 APKT 16	25	2	300	25	70	1,127			
S444	●	D30 d25 Z03 L300 APKT 16	30	3	300	25	60	1,168			
S446	●	D32 d32 Z03 L300 APKT 16	32	3	300	32	70	1,827			
S448	●	D35 d32 Z03 L300 APKT 16	35	3	300	32	65	1,879			
S450	●	D40 d32 Z04 L300 APKT 16	40	4	300	32	70	1,922			
S453	○	D32 d32 Z03 L350 APKT 16	32	3	350	32	80	2,274			
S454	○	D35 d32 Z03 L350 APKT 16	35	3	350	32	65	2,332			
S456	○	D40 d32 Z04 L350 APKT 16	40	4	350	32	55	2,375			

KRLY ucuna uygundur. / Compatible with KRLY insert. / Kompatibel für KRLY WP

● Stokta/In Stock/Lager ○ Sınırlı Stok/Limited Stock/Begrenzte Lagerhaltung

Kalite için Teknik Çözüm | Technical Solution For Quality



www.teknikcuttingtools.com

APMT 0602

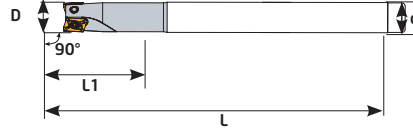
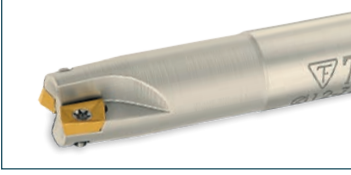

Ölçüler (mm) Dimensions(mm) Abmessungen (mm)		APMT 0602	
L	s		
6	2,6		

Sipariş Kodu Order Code Best.-Nr.	Stok/Stock/Lager	Ürün Kodu Product Code Produkt-Code	Ölçüler (mm) Dimensions(mm) Abmessungen (mm)							Kullanılan Uç Insert WSP	Sıkma Cıvatası Clamp Screw Torx-Schraube	Anahtar Torx Key Torx-Schlüssel
			D	Z	L	d	L1					
S003	●	D10 d10 Z02 L080 APMT 06	10	2	80	10	20	0,041				
S004	●	D12 d12 Z03 L080 APMT 06	12	3	80	12	25	0,060				
S005	●	D16 d16 Z04 L090 APMT 06	16	4	90	16	25	0,120				
S006	●	D20 d20 Z05 L110 APMT 06	20	5	110	20	30	0,240				
S007	●	D25 d25 Z07 L120 APMT 06	25	7	120	25	30	0,411				
S008	●	D32 d32 Z08 L120 APMT 06	32	8	120	32	35	0,686				
S009	●	D10 d10 Z02 L120 APMT 06	10	2	120	10	30	0,085				
S011	●	D12 d12 Z02 L120 APMT 06	12	2	120	12	30	0,120				

KRLY ucuna uygundur. / Compatible with KRLY insert. / Kompatible für KRLY WP

APMT 11T3

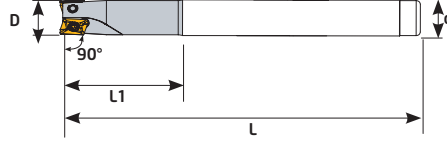

Ölçüler (mm) Dimensions(mm) Abmessungen (mm)		APMT 11T3	
L	s		
11	3,97		

Sipariş Kodu Order Code Best.-Nr.	Stok/Stock/Lager	Ürün Kodu Product Code Produkt-Code	D	Z	L	d	L1				
S224	●	D12 d16 Z01 L085 APMT 11	12	1	85	16	25	0,126			
S226	●	D14 d16 Z01 L090 APMT 11	14	1	90	16	25	0,139			
S228	●	D16 d16 Z02 L090 APMT 11	16	2	90	16	25	0,138			
S230	●	D16 d16 Z02 L180 APMT 11	16	2	180	16	30	0,280			
S232	●	D20 d20 Z02 L100 APMT 11	20	2	100	20	30	0,243			
S234	●	D20 d20 Z02 L210 APMT 11	20	2	210	20	30	0,523			
S236	●	D25 d25 Z03 L115 APMT 11	25	3	115	25	35	0,423			
S238	●	D25 d25 Z03 L180 APMT 11	25	3	180	25	40	0,749			
S240	●	D32 d32 Z04 L125 APMT 11	32	4	125	32	40	0,764			
S242	●	D32 d32 Z04 L180 APMT 11	32	4	180	32	50	1,123			

KRLY ucuna uygundur. / Compatible with KRLY insert. / Kompatible für KRLY WP

APMT 1604

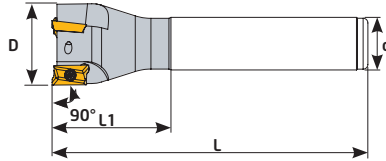

Ölçüler (mm) Dimensions(mm) Abmessungen (mm)		APMT 1604	
L	s		
16,4	4,76		

Sipariş Kodu Order Code Best.-Nr.	Stok/Stock/Lager	Ürün Kodu Product Code Produkt-Code	D	Z	L	d	L1				
S245	●	D25 d25 Z02 L150 APMT 16	25	2	150	25	55	0,610			
S247	●	D32 d25 Z03 L120 APMT 16	32	3	120	25	45	0,495			
S248	●	D32 d32 Z03 L150 APMT 16	32	3	150	32	55	0,874			
S250	●	D40 d25 Z04 L120 APMT 16	40	4	120	25	45	0,544			
S251	●	D40 d32 Z04 L150 APMT 16	40	4	150	32	55	1,294			

KRLY ucuna uygundur. / Compatible with KRLY insert. / Kompatible für KRLY WP



APKT 1003-1604

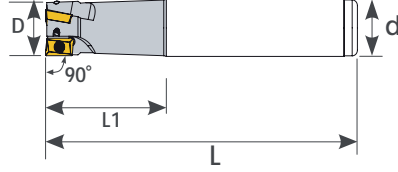

Ölçüler (mm) Dimensions(mm) Abmessungen (mm)		APKT 1003 APKT 1604
L	s	
10,5 16,3	3,6 5,3	

Sipariş Kodu Order Code Best.-Nr.	Stok/Stock/Lager	Ürün Kodu Product Code Produkt-Code	Ölçüler (mm) Dimensions(mm) Abmessungen (mm)						Kullanılan Uç Insert WSP	Sıkma Civatası Clamp Screw Torx-Schraube	Anahtar Torx Key Torx-Schlüssel
			D	Z	L	d	L1	kg			
S031	●	D16 - Z02 L100 APKT 10	16	2	100	16	30	0,275	APKT 1003 YG1	TC060 M2,5x5,5	T8
S032	●	D20 - Z03 L100 APKT 10	20	3	100	20	30	0,342			
S033	●	D25 - Z03 L100 APKT 10	25	3	100	25	35	0,376			
S034	●	D32 - Z04 L100 APKT 10	32	4	100	25	35	0,768			
S035	●	D16 - Z02 L150 APKT 10	16	2	150	16	50	0,320		TC063 M2,5x7	
S036	●	D20 - Z03 L150 APKT 10	20	3	150	20	60	0,368			
S037	●	D25 - Z03 L150 APKT 10	25	3	150	25	60	0,541		TC060 M2,5x5,5	
S038	●	D32 - Z04 L150 APKT 10	32	4	150	32	45	0,946			
S046	●	D40 - Z04 L120 APKT 16	40	4	120	25	45	0,516	APKT 1604 YG1	TC074 M4x10	T15

YG1 ucuna uygundur. / Compatible with YG1 insert. / Kompatible für YG1 WP

R390-11T3

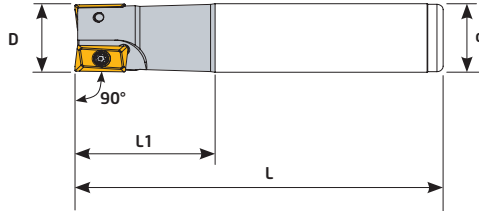
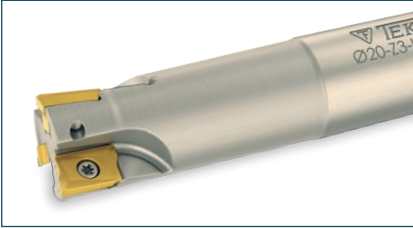

Ölçüler (mm) Dimensions(mm) Abmessungen (mm)		R390-11T3
L	s	
11	3,18	

Sipariş Kodu Order Code Best.-Nr.	Stok/Stock/Lager	Ürün Kodu Product Code Produkt-Code	Ölçüler (mm) Dimensions(mm) Abmessungen (mm)						Sıkma Civatası Clamp Screw Torx-Schraube	Kullanılan Uç Insert WSP	Anahtar Torx Key Torx-Schlüssel
			D	Z	L	d	L1	kg			
S591	●	D16 d16 Z02 L120 R390 11	16	2	120	16	40	0,180	TC060 M2,5x5,5	R390-11T3 SNDVK	T8
S592	●	D20 d20 Z03 L120 R390 11	20	3	120	20	40	0,270	TC063 M2,5x7		
S592-1	●	D25 d25 Z03 L120 R390 11	25	3	120	25	45	0,446	TC063 M2,5x7		
S593	●	D16 d16 Z02 L150 R390 11	16	2	150	16	40	0,229	TC060 M2,5x5,5		
S594	●	D20 d20 Z03 L150 R390 11	20	3	150	20	50	0,348	TC063 M2,5x7		
S594-1	●	D21 d20 Z03 L150 R390 11	21	3	150	20	50	0,366	TC060 M2,5x5,5		
S595	●	D25 d25 Z03 L150 R390 11	25	3	150	25	50	0,557	TC063 M2,5x7		
S595-1	●	D26 d25 Z04 L150 R390 11	26	4	150	25	50	0,557			
S596	●	D20 d20 Z03 L200 R390 11	20	3	200	20	50	0,480	TC060 M2,5x5,5		
S597	●	D25 d25 Z03 L200 R390 11	25	3	200	25	50	0,762	TC063 M2,5x7		
S598	●	D25 d25 Z03 L250 R390 11	25	3	250	25	60	0,951			

SNDVK ucuna uygundur. / Compatible with SNDVK insert. / Kompatible für SNDVK WP

● Stokta/ In Stock/ Lager ○ Sınırlı Stok/ Limited Stock/ Begrenzte Lagerhaltung

Kalite için Teknik Çözüm | Technical Solution For Quality



R390-1704

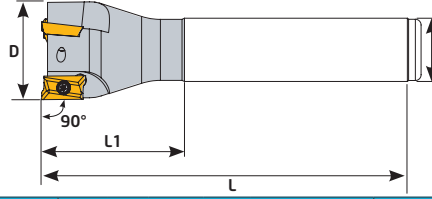

Ölçüler (mm) Dimensions(mm) Abmessungen (mm)		R390-1704	
L	s		
17	4,76		

Sipariş Kodu Order Code Best.-Nr.	Stok/Stock/Lager	Ürün Kodu Product Code Produkt-Code	Ölçüler (mm) Dimensions(mm) Abmessungen (mm)						Kullanılan Uç Insert WSP	Sıkma Civatası Clamp Screw Torx-Schraube	Anahtar Torx Key Torx-Schlüssel
			D	Z	L	d	L1	kg			
S510	●	D25 d25 Z02 L120 R390 17	25	2	120	25	45	0,425	R390-1704 SNDVK	TC067 M3,5x8,5	T15
S512	●	D30 d25 Z03 L120 R390 17	30	3	120	25	45	0,461			
S514	●	D32 d25 Z03 L120 R390 17	32	3	120	25	45	0,459			
S518	●	D40 d32 Z04 L120 R390 17	40	4	120	32	45	0,782			
S520	●	D25 d25 Z02 L150 R390 17	25	2	150	25	55	0,536			
S522	●	D30 d25 Z03 L150 R390 17	30	3	150	25	55	0,582			
S524	●	D32 d32 Z03 L150 R390 17	32	3	150	32	55	0,854			
S528	●	D40 d32 Z04 L150 R390 17	40	4	150	32	55	0,936			
S530	●	D25 d25 Z02 L200 R390 17	25	2	200	25	60	0,741			
S532	●	D30 d25 Z03 L200 R390 17	30	3	200	25	55	0,773			
S534	●	D32 d32 Z03 L200 R390 17	32	3	200	32	55	0,781			
S538	●	D40 d32 Z04 L200 R390 17	40	4	200	32	55	1,272			

SNDVK ucuna uygundur. / Compatible with SNDVK insert. / Kompatible für SNDVK WP

R390-1806

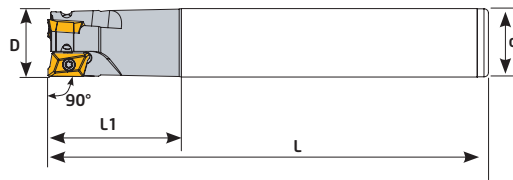

Ölçüler (mm) Dimensions(mm) Abmessungen (mm)		R390-1806	
L	s		
18	6,3		

Sipariş Kodu Order Code Best.-Nr.	Stok/Stock/Lager	Ürün Kodu Product Code Produkt-Code	Ölçüler (mm) Dimensions(mm) Abmessungen (mm)						Kullanılan Uç Insert WSP	Sıkma Civatası Clamp Screw Torx-Schraube	Anahtar Torx Key Torx-Schlüssel
			D	Z	L	d	L1	kg			
S603	●	D25 d25 Z02 L150 R390 18	25	2	150	25	60	0,530	R390-1806 SNDVK	TC074 M4x10	T15
S600	●	D25 d25 Z02 L200 R390 18	25	2	200	25	60	0,756			
S605	●	D32 d32 Z03 L150 R390 18	32	3	150	32	60	0,850			
S601	●	D32 d32 Z03 L200 R390 18	32	3	200	32	60	1,188			

SNDVK ucuna uygundur. / Compatible with SNDVK insert. / Kompatible für SNDVK WP



XOMX 0602-0903-1204

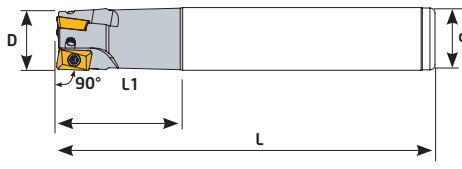

Ölçüler (mm) Dimensions(mm) Abmessungen (mm)		XOMX 1204	
L	s		
12	5,06		

Sipariş Kodu Order Code Best.-Nr.	Stok/Stock/Lager	Ürün Kodu Product Code Produkt-Code	Ölçüler (mm) Dimensions(mm) Abmessungen (mm)						Sıkma Civatası Clamp Screw Torx-Schraube	Kullanılan Uç Insert WSP	Anahtar Torx Key Torx-Schlüssel
			D	Z	L	d	L1				
S623	●	D10 d10 Z02 L120 XOMX 06	10	2	120	10	40	0,086	TC057-1 M1,8x4	XOMX 0602 SCO	T6
S625	●	D12 d12 Z02 L120 XOMX 06	12	2	120	12	30	0,119			
S627	●	D16 d16 Z02 L120 XOMX 09	16	2	120	16	45	0,197	TC060 M2,5x5,5	XOMX 0903 SCO	T8
S626	●	D20 d20 Z03 L120 XOMX 09	20	3	120	20	40	0,297			
S629	●	D16 d16 Z02 L150 XOMX 09	16	2	150	16	45	0,228			
S628	●	D20 d20 Z03 L150 XOMX 09	20	3	150	20	55	0,373			
S636	●	D20 d20 Z03 L200 XOMX 09	20	3	200	20	55	0,507			
S632	●	D25 d25 Z03 L150 XOMX 09	25	3	150	25	55	0,352			
S638	●	D20 d20 Z02 L120 XOMX 12	20	2	120	20	45	0,500			
S640	●	D20 d20 Z02 L150 XOMX 12	20	2	150	20	55	0,439			
S641	●	D20 d20 Z02 L200 XOMX 12	20	2	200	20	60	0,504			
S642	●	D25 d25 Z03 L120 XOMX 12	25	3	120	25	45	0,443			
S643	●	D25 d25 Z03 L150 XOMX 12	25	3	150	25	55	0,574			
S644	●	D25 d25 Z03 L200 XOMX 12	25	3	200	25	60	0,779			
S645	●	D25 d25 Z03 L250 XOMX 12	25	3	250	25	70	0,856			
S647	●	D32 d32 Z04 L120 XOMX 12	32	4	120	25	45	0,965			
S648	●	D32 d32 Z04 L150 XOMX 12	32	4	150	32	55	0,937			
S650	●	D40 d32 Z04 L150 XOMX 12	40	4	150	32	45	1,047			

SCO ucuna uygundur. / Compatible with SCO insert. / Kompatible für SCO WP

APKT 0903

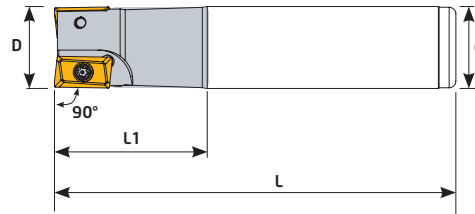
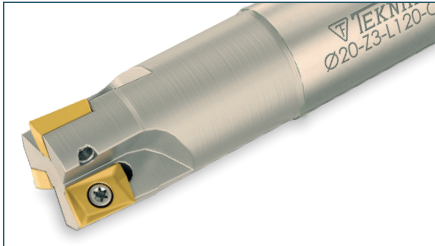

Ölçüler (mm) Dimensions(mm) Abmessungen (mm)		APKT 0903	
L	S		
9,52	3,18		

Sipariş Kodu Order Code Best.-Nr.	Stok/Stock/Lager	Ürün Kodu Product Code Produkt-Code	Ölçüler (mm) Dimensions(mm) Abmessungen (mm)						Sıkma Civatası Clamp Screw Torx-Schraube	Kullanılan Uç Insert WSP	Anahtar Torx Key Torx-Schlüssel
			D	Z	L	d	L1				
S204	●	D16 d16 Z02 L120 APKT 09	16	2	120	16	40	0,185	TC060 M2,5x5,5	APKT 0903 WLTR	T8
S206	●	D20 d20 Z03 L120 APKT 09	20	3	120	20	45	0,278			
S208	●	D25 d25 Z03 L120 APKT 09	25	3	120	25	45	0,453	TC063 M2,5x7		
S210	●	D16 d16 Z02 L150 APKT 09	16	2	150	16	50	0,237			
S212	●	D20 d20 Z03 L150 APKT 09	20	3	150	20	45	0,354	TC063 M2,5x7		
S214	●	D25 d25 Z03 L150 APKT 09	25	3	150	25	45	0,590			
S216	●	D16 d16 Z02 L200 APKT 09	16	2	200	16	60	0,340	TC060 M2,5x5,5		
S218	●	D20 d20 Z03 L200 APKT 09	20	3	200	20	60	0,502			
S220	●	D25 d25 Z03 L200 APKT 09	25	3	200	25	60	0,765	TC063 M2,5x7		

WLTR ucuna uygundur. / Compatible with WLTR insert. / Kompatible für WLTR WP

● Stokta/ In Stock/ Lager ○ Sınırlı Stok/ Limited Stock/ Begrenzte Lagerhaltung

Kalite için Teknik Çözüm | Technical Solution For Quality



www.teknikcuttingtools.com

ADMT 1204

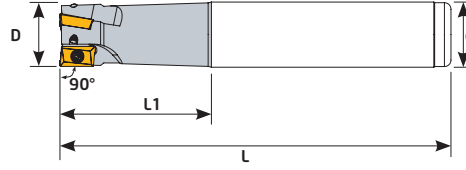
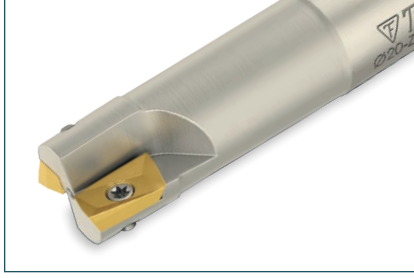

Ölçüler (mm) Dimensions(mm) Abmessungen (mm)		ADMT 1204	
L	S		
13,6	4,76		

Sipariş Kodu Order Code Best.-Nr.	Stok/Stock/Lager	Ürün Kodu Product Code Produkt-Code	Ölçüler (mm) Dimensions(mm) Abmessungen (mm)							Kullanılan Uç Insert WSP	Sıkma Civatası Clamp Screw Torx-Schraube	Anahtar Torx Key Torx-Schlüssel
			D	Z	L	d	L1	kg				
S498	●	D20 d20 Z02 L120 ADMT 12	20	2	120	20	40	0,275	ADMT1204 WLTR	TC065 M3x7	T8	
S500	●	D20 d20 Z02 L150 ADMT 12	20	2	150	20	55	0,348				
S501	●	D20 d20 Z02 L200 ADMT 12	20	2	200	20	60	0,498				
S501-1	●	D25 d25 Z03 L120 ADMT 12	25	3	120	25	40	0,443				
S502	●	D25 d25 Z03 L150 ADMT 12	25	3	150	25	60	0,550				
S503	●	D30 d25 Z04 L150 ADMT 12	30	4	150	25	60	0,558				
S504	●	D32 d32 Z04 L150 ADMT 12	32	4	150	32	50	0,932				
S506	●	D40 d32 Z05 L150 ADMT 12	40	5	150	32	50	0,968				

WLTR ucuna uygundur. / Compatible with WLTR insert. / Kompatible für WLTR WP

ADMT 1606

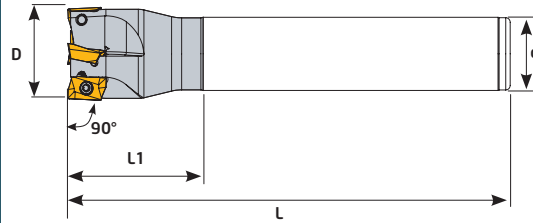

Ölçüler (mm) Dimensions(mm) Abmessungen (mm)		ADMT 1606	
L	S		
17,5	6,15		

Sipariş Kodu Order Code Best.-Nr.	Stok/Stock/Lager	Ürün Kodu Product Code Produkt-Code	Ölçüler (mm) Dimensions(mm) Abmessungen (mm)							Kullanılan Uç Insert WSP	Sıkma Civatası Clamp Screw Torx-Schraube	Anahtar Torx Key Torx-Schlüssel
			D	Z	L	d	L1	kg				
S460	●	D25 d25 Z02 L150 ADMT 16	25	2	150	25	60	0,534	ADMT1606 WLTR	TC079 M4x10	T15	
S461	●	D25 d25 Z02 L200 ADMT 16	25	2	200	25	60	0,744				
S463	●	D26 d25 Z02 L150 ADMT 16	26	2	150	25	60	0,545				
S464	●	D26 d25 Z02 L200 ADMT 16	26	2	200	25	60	0,751				
S466	●	D32 d32 Z03 L150 ADMT 16	32	3	150	32	60	0,784				
S467	●	D32 d32 Z03 L200 ADMT 16	32	3	200	32	60	1,085				
S469	●	D40 d32 Z04 L150 ADMT 16	40	4	150	32	60	0,927				
S470	●	D40 d32 Z04 L200 ADMT 16	40	4	200	32	60	1,310				

WLTR ucuna uygundur. / Compatible with WLTR insert. / Kompatible für WLTR WP



AXMT 0602 - APKT 0903

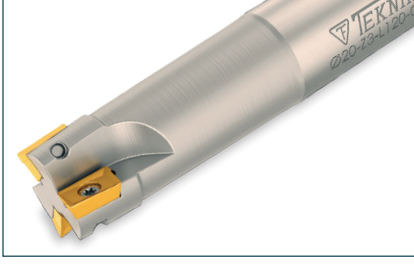

Ölçüler (mm) Dimensions(mm) Abmessungen (mm)		AXMT 0602
L	s	
6	2,6	APKT 0903
9,5	3,6	

Sipariş Kodu Order Code Best.-Nr.	Stok/Stock/Lager	Ürün Kodu Product Code Produkt-Code	Ölçüler (mm) Dimensions(mm) Abmessungen (mm)						Kullanılan Uç Insert WSP	Sıkma Cıvatası Clamp Screw Torx-Schraube	Anahtar Torx Key Torx-Schlüssel
			D	Z	L	d	L1				
S010	●	D10 d10 Z02 L120 AXMT 06	10	2	120	10	30	0,085	AXMT 0602 TGTC	TC057-1 M1,8x4	T6
S012	●	D12 d12 Z02 L120 AXMT 06	12	2	120	12	30	0,119			
S014	●	D16 d16 Z02 L120 APKT 09	16	2	120	16	40	0,195	APKT 0903 TGTC	TC060 M2,5x5,5	T8
S016	●	D20 d20 Z03 L120 APKT 09	20	3	120	20	45	0,296			
S018	●	D25 d25 Z03 L120 APKT 09	25	3	120	25	45	0,447			
S020	●	D16 d16 Z02 L150 APKT 09	16	2	150	16	50	0,233			
S022	●	D20 d20 Z03 L150 APKT 09	20	3	150	20	60	0,370			
S024	●	D25 d25 Z03 L150 APKT 09	25	3	150	25	60	0,583			

TGTC ucuna uygundur. / Compatible with TGTC insert. / Kompatible für TGTC WP

APKT 1705

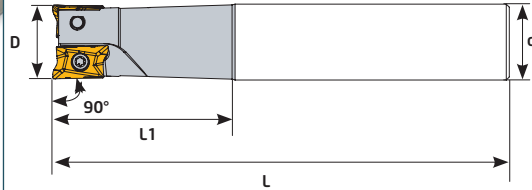

Ölçüler (mm) Dimensions(mm) Abmessungen (mm)		APKT 1705
L	S	
17	5,56	

Sipariş Kodu Order Code Best.-Nr.	Stok/Stock/Lager	Ürün Kodu Product Code Produkt-Code	Ölçüler (mm) Dimensions(mm) Abmessungen (mm)						Kullanılan Uç Insert WSP	Sıkma Cıvatası Clamp Screw Torx-Schraube	Anahtar Torx Key Torx-Schlüssel
			D	Z	L	d	L1				
S660	●	D25 d25 Z02 L150 APKT 17	25	2	150	25	60	0,534	APKT 1705 TGTC	TC074 M4x10	T15
S660-1	●	D25 d25 Z02 L200 APKT 17	25	2	200	25	60	0,763			
S662	●	D32 d32 Z03 L150 APKT 17	32	3	150	32	60	0,850			
S662-1	●	D32 d32 Z03 L200 APKT 17	32	3	200	32	60	1,236			
S664	●	D40 d32 Z04 L150 APKT 17	40	4	150	32	60	0,850			

TGTC ucuna uygundur. / Compatible with TGTC insert. / Kompatible für TGTC WP

● Stokta/In Stock/Lager ○ Sınırlı Stok/Limited Stock/Begrenzte Lagerhaltung

Kalite için Teknik Çözüm | Technical Solution For Quality

BROTECH

TEKNİK
Cutting Tools

www.teknikcuttingtools.com

83

APKT 1003

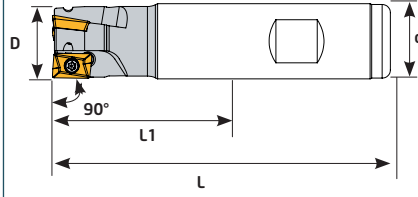

Ölçüler (mm) Dimensions(mm) Abmessungen (mm)		APKT 1003	
L	s		
10,5	3,6		

Sipariş Kodu Order Code Best.-Nr.	Stok/Stock/Lager	Ürün Kodu Product Code Produkt-Code	Ölçüler (mm) Dimensions(mm) Abmessungen (mm)							Kullanılan Uç Insert WSP	Sıkma Cıvatası Clamp Screw Torx-Schraube	Anahtar Torx Key Torx-Schlüssel
			D	Z	L	d	L1	kg				
S766	●	D16 d16 Z02 L085 APKT 10	16	2	85	16	26	0,123	APKT 1003 PLBT	TC060 M2,5x5,5	T8	
S767	●	D20 d20 Z03 L090 APKT 10	20	3	90	20	28	0,209				
S768	●	D25 d20 Z04 L150 APKT 10	25	4	150	20	26	0,388				

PLBT ucuna uygundur. / Compatible with PLBT insert. / Kompatible für PLBT WP

BDMT 11T3

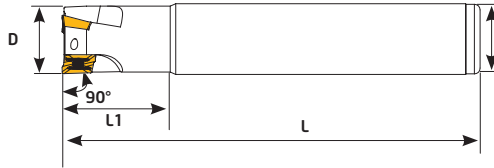
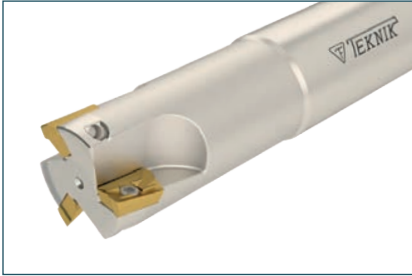

Ölçüler (mm) Dimensions(mm) Abmessungen (mm)		BDMT 11T3	
L	s		
11	3,80		

Sipariş Kodu Order Code Best.-Nr.	Stok/Stock/Lager	Ürün Kodu Product Code Produkt-Code	Ölçüler (mm) Dimensions(mm) Abmessungen (mm)							Kullanılan Uç Insert WSP	Sıkma Cıvatası Clamp Screw Torx-Schraube	Anahtar Torx Key Torx-Schlüssel
			D	Z	L	d	L1	kg				
S565	●	D16 d16 Z02 L150 BDMT 11	16	2	150	16	45	0,232	BDMT 11T3 KYCRA	TC060 M2,5x5,5	T8	
S566	●	D18 d16 Z02 L150 BDMT 11	18	2	150	16	44	0,240				
S567	●	D20 d20 Z03 L150 BDMT 11	20	3	150	20	50	0,351				
S569	●	D25 d25 Z03 L150 BDMT 11	25	3	150	25	50	0,563				
S570	●	D25 d25 Z03 L200 BDMT 11	25	3	200	25	60	0,764				
S572	●	D32 d32 Z04 L150 BDMT 11	32	4	150	32	50	0,961				
S574	●	D32 d32 Z04 L200 BDMT 11	32	4	200	32	60	1,294				

KYCRA ucuna uygundur. / Compatible with KYCRA insert. / Kompatible für KYCRA WP



BDMT 1704

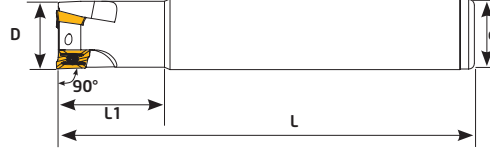

Ölçüler (mm) Dimensions(mm) Abmessungen (mm)		BDMT 1704	
L	S		
17	4,90		

Sipariş Kodu Order Code Best.-Nr.	Stok/Stock/Lager	Ürün Kodu Product Code Produkt-Code	Ölçüler (mm) Dimensions(mm) Abmessungen (mm)						Kullanılan Uç Insert WSP	Sıkma Civatası Clamp Screw Torx-Schraube	Anahtar Torx Key Torx-Schlüssel
			D	Z	L	d	L1	kg			
S578	●	D25 d25 Z02 L120 BDMT 17	25	2	120	25	35	0,432	BDMT 1704 KYCRA	TC073 M4x7	T15
S579	●	D25 d25 Z02 L150 BDMT 17	25	2	150	25	50	0,548			
S581	●	D32 d25 Z03 L120 BDMT 17	32	3	120	25	40	0,480		TC074 M4x10	
S582	●	D32 d32 Z03 L150 BDMT 17	32	3	150	32	60	0,895			
S584	●	D40 d32 Z04 L120 BDMT 17	40	4	120	32	40	0,790			
S585	●	D40 d32 Z04 L150 BDMT 17	40	4	150	32	40	0,985			

KYCRA ucuna uygundur. / Compatible with KYCRA insert. / Kompatibel für KYCRA WP

BOMT 1304

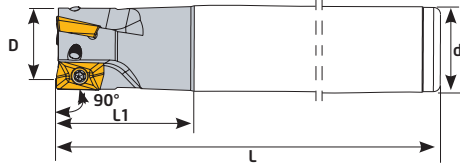

Ölçüler (mm) Dimensions(mm) Abmessungen (mm)			BOMT 1304	
L	S	A		
13	4,5	8		

Sipariş Kodu Order Code Best.-Nr.	Stok/Stock/Lager	Ürün Kodu Product Code Produkt-Code	Ölçüler (mm) Dimensions(mm) Abmessungen (mm)						Kullanılan Uç Insert WSP	Sıkma Civatası Clamp Screw Torx-Schraube	Anahtar Torx Key Torx-Schlüssel
			D	Z	L	d	L1	kg			
S850	●	D20 d20 Z02 L120 BOMT 13	20	2	120	20	40	0,289	BOMT 1304 INGRSLL	TC069 M3,5x8,5	T10
S851	●	D20 d20 Z02 L150 BOMT 13	20	2	150	20	40	0,356			
S852	●	D25 d25 Z03 L120 BOMT 13	25	3	120	25	40	0,451			
S853	●	D25 d25 Z03 L150 BOMT 13	25	3	150	25	40	0,556			

INGRSLL ucuna uygundur. / Compatible with INGRSLL insert. / Kompatibel für INGRSLL WP

● Stokta/In Stock/Lager ○ Sınırlı Stok/Limited Stock/Begrenzte Lagerhaltung

Kalite için Teknik Çözüm | Technical Solution For Quality

BROTECH

TEKNİK
Cutting Tools

www.teknikcuttingtools.com

85

ADKT 1505

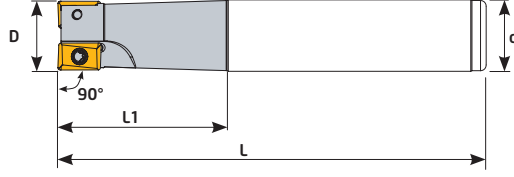
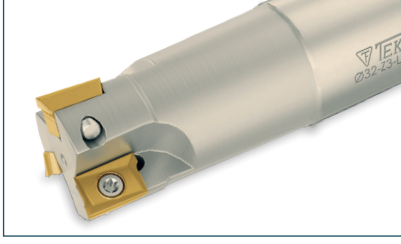

Ölçüler (mm) Dimensions(mm) Abmessungen (mm)		ADKT 1505	
L	S		
15,7	5,63		

Sipariş Kodu Order Code Best.-Nr.	Stok/Stock/Lager	Ürün Kodu Product Code Produkt-Code	Ölçüler (mm) Dimensions(mm) Abmessungen (mm)						Kullanılan Uç Insert WSP	Sıkma Cıvatası Clamp Screw Torx-Schraube	Anahtar Torx Key Torx-Schlüssel
			D	Z	L	d	L1	kg			
S304	●	D25 d25 Z02 L120 ADKT 15	25	2	120	25	45	0,434	ADKT 1505 ISCR	TC074 M4x10	T15
S306	●	D30 d25 Z03 L120 ADKT 15	30	3	120	25	45	0,466			
S307	●	D32 d25 Z03 L120 ADKT 15	32	3	120	25	45	0,477			
S308	●	D35 d25 Z03 L120 ADKT 15	35	3	120	25	45	0,500			
S310	●	D40 d32 Z04 L120 ADKT 15	40	4	120	32	45	0,759			
S312	●	D25 d25 Z02 L150 ADKT 15	25	2	150	25	60	0,550			
S314	●	D30 d25 Z03 L150 ADKT 15	30	3	150	25	50	0,596			
S315	●	D32 d32 Z03 L150 ADKT 15	32	3	150	32	60	0,887			
S316	●	D35 d32 Z03 L150 ADKT 15	35	3	150	32	50	0,920			
S318	●	D25 d25 Z02 L200 ADKT 15	25	2	200	25	55	0,711			
S319	●	D30 d25 Z03 L200 ADKT 15	30	3	200	25	50	0,783			
S320	●	D32 d32 Z03 L200 ADKT 15	32	3	200	32	60	1,198			
S321	●	D35 d32 Z03 L200 ADKT 15	35	3	200	32	50	1,252			
S322	●	D40 d32 Z04 L200 ADKT 15	40	4	200	32	60	1,272			

ISCR ucuna uygundur. / Compatible with ISCR insert. / Kompatible für ISCR WP

ADMX 0702

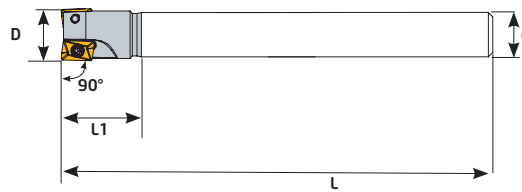

Ölçüler (mm) Dimensions(mm) Abmessungen (mm)		ADMX 0702	
L	S		
7,28	2,48		

Sipariş Kodu Order Code Best.-Nr.	Stok/Stock/Lager	Ürün Kodu Product Code Produkt-Code	Ölçüler (mm) Dimensions(mm) Abmessungen (mm)						Kullanılan Uç Insert WSP	Sıkma Cıvatası Clamp Screw Torx-Schraube	Anahtar Torx Key Torx-Schlüssel
			D	Z	L	d	L1	kg			
S751	○	D10 d10 Z02 L080 ADMX 07	10	2	80	10	16	0,062	ADMX 0702 PRMT	TC058 M2x4,2	T6
S759	○	D16 d16 Z03 L160 ADMX 07	16	3	160	16	18	0,205			
S760	○	D20 d20 Z04 L125 ADMX 07	20	4	125	20	17	0,293			
S761	○	D20 d20 Z05 L125 ADMX 07	20	5	125	20	17	0,300			

PRMT ucuna uygundur. / Compatible with PRMT insert. / Kompatible für PRMT WP



3PKT 1004

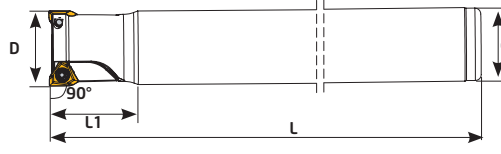

Ölçüler (mm) Dimensions(mm) Abmessungen (mm)			3PKT 1004	
d	L	S		
6,9	7	4		

Sipariş Kodu Order Code Best.-Nr.	Stok/Stock/Lager	Ürün Kodu Product Code Produkt-Code	Ölçüler (mm) Dimensions(mm) Abmessungen (mm)						Kullanılan Uç Insert WSP	Sıkma Civatası Clamp Screw Torx-Schraube	Anahtar Torx Key Torx-Schlüssel
			D	Z	L	d	L1	kg			
S485	●	D21 d20 Z02 L200 3PKT 10	21	2	200	20	30	1,259			
S486	●	D26 d25 Z02 L200 3PKT 10	26	2	200	25	30	0,773			
S487	●	D33 d32 Z03 L200 3PKT 10	33	3	200	32	40	0,495			

TGTC ucuna uygundur. / Compatible with TGTC insert. / Kompatibel für TGTC WP

4NKT 0603

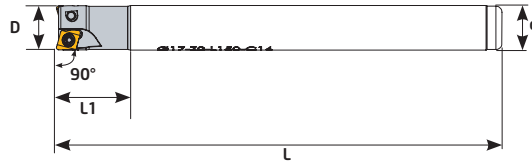

Ölçüler (mm) Dimensions(mm) Abmessungen (mm)		4NKT 0603	
L	S		
6,6	4,67		

Sipariş Kodu Order Code Best.-Nr.	Stok/Stock/Lager	Ürün Kodu Product Code Produkt-Code	Ölçüler (mm) Dimensions(mm) Abmessungen (mm)						Kullanılan Uç Insert WSP	Sıkma Civatası Clamp Screw Torx-Schraube	Anahtar Torx Key Torx-Schlüssel
			D	Z	L	d	L1	kg			
S471	●	D16 d16 Z02 L120 4NKT 06	16	2	120	16	25	0,200			
S471-1	●	D16 d16 Z02 L150 4NKT 06	16	2	150	16	25	0,250			
S472	●	D17 d16 Z02 L150 4NKT 06	17	2	150	16	22	0,241			
S473	●	D20 d20 Z03 L120 4NKT 06	20	3	120	20	25	0,306			
S474	●	D21 d20 Z03 L200 4NKT 06	21	3	200	20	25	0,524			
S475	●	D25 d25 Z04 L120 4NKT 06	25	4	120	25	30	0,474			
S475-1	●	D25 d25 Z03 L200 4NKT 06	25	3	200	25	30	0,806			
S476	●	D26 d25 Z03 L200 4NKT 06	26	3	200	25	30	0,815			
S477	●	D33 d32 Z04 L200 4NKT 06	33	4	200	32	35	1,327			
S477-1	●	D33 d32 Z04 L220 4NKT 06	33	4	220	32	35	1,462			
S477-2	●	D40 d32 Z05 L200 4NKT 06	40	5	200	32	40	1,395			

TGTC ucuna uygundur. / Compatible with TGTC insert. / Kompatibel für TGTC WP

XNKT 0604

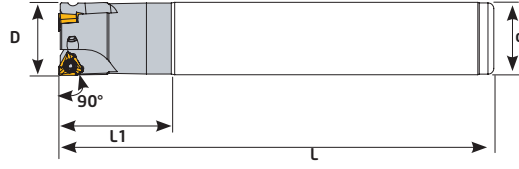

Ölçüler (mm) Dimensions(mm) Abmessungen (mm)			XNKT 0604	
d	l	S		
6,5	5,7	4		

Sipariş Kodu Order Code Best.-Nr.	Stok/Stock/Lager	Ürün Kodu Product Code Produkt-Code	Ölçüler (mm) Dimensions(mm) Abmessungen (mm)						Kullanılan Uç Insert WSP	Sıkma Cıvatası Clamp Screw Torx-Schraube	Anahtar Torx Key Torx-Schlüssel
			D	Z	L	d	L1	kg			
S834	●	D20 d20 Z02 L150 XNKT 06	20	2	150	20	40	0,365	XNKT 0604 KRLY	TC065-1 M3x7	T8
S836	●	D21 d20 Z02 L150 XNKT 06	21	2	150	20	40	0,372			
S838	●	D25 d25 Z03 L150 XNKT 06	25	3	150	25	40	0,572			
S840	●	D26 d25 Z03 L150 XNKT 06	26	3	150	25	40	0,572			
S841	●	D32 d32 Z04 L150 XNKT 06	32	4	150	32	40	0,941			
S842	●	D40 d32 Z05 L130 XNKT 06	40	5	130	32	45	0,865			

KRLY ucuna uygundur. / Compatible with KRLY insert. / Kompatibel für KRLY WP

XNKT 0805

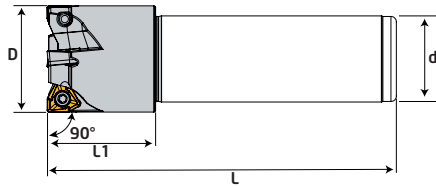
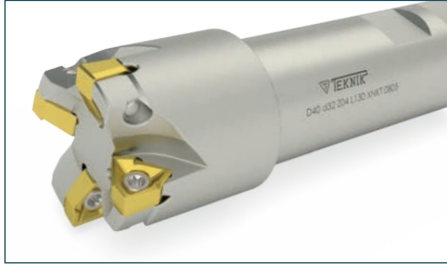

Ölçüler (mm) Dimensions(mm) Abmessungen (mm)			XNKT 0805	
d	l	s		
10	8,2	5,5		

Sipariş Kodu Order Code Best.-Nr.	Stok/Stock/Lager	Ürün Kodu Product Code Produkt-Code	Ölçüler (mm) Dimensions(mm) Abmessungen (mm)						Kullanılan Uç Insert WSP	Sıkma Cıvatası Clamp Screw Torx-Schraube	Anahtar Torx Key Torx-Schlüssel
			D	Z	L	d	L1	kg			
S843	●	D32 d32 Z03 L125 XNKT 08	32	3	125	32	37	0,817	XNKT 0805 KRLY	TC072 M4x10	T15
S844	●	D40 d32 Z04 L130 XNKT 08	40	4	130	32	40	0,986			

KRLY ucuna uygundur. / Compatible with KRLY insert. / Kompatibel für KRLY WP

ANKX 1205

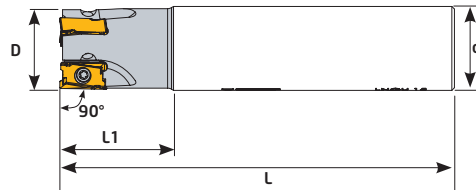
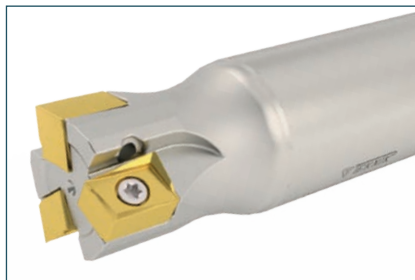

Ölçüler (mm) Dimensions(mm) Abmessungen (mm)			ANKX 1205	
L	S	A		
13,7	9,15	9,3		

Sipariş Kodu Order Code Best.-Nr.	Stok/Stock/Lager	Ürün Kodu Product Code Produkt-Code	Ölçüler (mm) Dimensions(mm) Abmessungen (mm)						Kullanılan Uç Insert WSP	Sıkma Cıvatası Clamp Screw Torx-Schraube	Anahtar Torx Key Torx-Schlüssel
			D	Z	L	d	L1	kg			
S695	●	D32 d32 Z03 L120 ANKX 12	32	3	120	32	40	0,700	ANKX1205 ISCR	TC074 M4x10	T15

ISCR ucuna uygundur. / Compatible with ISCR insert. / Kompatibel für ISCR WP

● Stokta/In Stock/Lager ○ Sınırlı Stok/Limited Stock/Begrenzte Lagerhaltung



ANHX 1004 - 1206

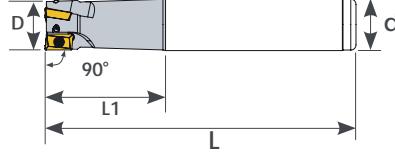

Ölçüler (mm) Dimensions(mm) Abmessungen (mm)			ANHX 1004 ANHX 1206	
A	S	L		
6,6 9	6,2 8,3	10 12		

Sipariş Kodu Order Code Best.-Nr.	Stok/Stock/Lager	Ürün Kodu Product Code Produkt-Code	Ölçüler (mm) Dimensions(mm) Abmessungen (mm)						Kullanılan Uç Insert WSP	Sıkma Cıvatası Clamp Screw Torx-Schraube	Anahtar Torx Key Torx-Schlüssel
			D	Z	L	d	L1				
S775	●	D16 d16 Z02 L090 ANHX 10	16	2	90	16	25	0,140			
S776	●	D20 d20 Z02 L100 ANHX 10	20	2	100	20	30	0,247			
S762	●	D25 d25 Z03 L115 ANHX 10	25	3	115	25	35	0,432			
S763	●	D32 d32 Z03 L125 ANHX 10	32	3	125	32	40	0,783			
S782	●	D16 d16 Z02 L160 ANHX 10	16	2	160	16	25	0,036			
S783	●	D20 d20 Z03 L160 ANHX 10	20	3	160	20	30	0,058			
S784	●	D25 d25 Z03 L180 ANHX 10	25	3	180	25	35	0,099			
S785	●	D32 d32 Z04 L150 ANHX 10	32	4	150	32	40	0,136			
S764	●	D25 d25 Z02 L110 ANHX 12	25	2	110	25	35	0,405			
S765	●	D32 d32 Z03 L150 ANHX 12	32	3	150	32	35	0,922			

PLBT ucuna uygundur. / Compatible with PLBT insert. / Kompatibel für PLBT WP

LNGU 15T6

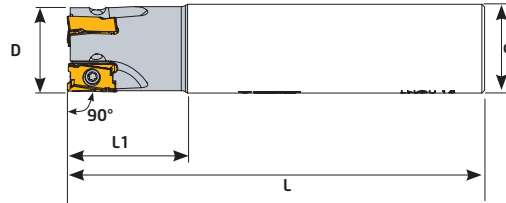
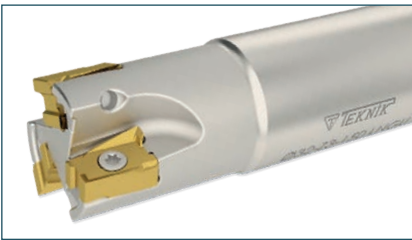

Ölçüler (mm) Dimensions(mm) Abmessungen (mm)			LNGU 15T6	
L	S	A		
17	6,96	10		

Sipariş Kodu Order Code Best.-Nr.	Stok/Stock/Lager	Ürün Kodu Product Code Produkt-Code	Ölçüler (mm) Dimensions(mm) Abmessungen (mm)						Kullanılan Uç Insert WSP	Sıkma Cıvatası Clamp Screw Torx-Schraube	Anahtar Torx Key Torx-Schlüssel
			D	Z	L	d	L1				
S950	●	D25 d25 Z02 L150 LNGU 15	25	2	150	25	45	0,547			
S951	●	D32 d32 Z03 L150 LNGU 15	32	3	150	32	45	0,884			

KNNMTL ucuna uygundur. / Compatible with KNNMTL insert. / Kompatibel für KNNMTL WP

LNMX 1006

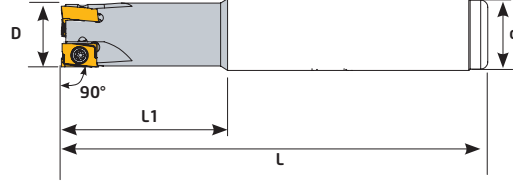

Ölçüler (mm) Dimensions(mm) Abmessungen (mm)		LNMX 1006	
L	s		
10	6,6		

Sipariş Kodu Order Code Best.-Nr.	Stok/Stock/Lager	Ürün Kodu Product Code Produkt-Code	Ölçüler (mm) Dimensions(mm) Abmessungen (mm)						Kullanılan Uç Insert WSP	Sıkma Civatası Clamp Screw Torx-Schraube	Anahtar Torx Key Torx-Schlüssel
			D	Z	L	d	L1				
LN096	○	D16 d16 Z01 L090 LNMX 10	16	1	90	16	25	0,140			
LN097	○	D22 d20 Z02 L100 LNMX 10	22	2	100	20	-	0,263			
LN098	○	D24 d25 Z03 L100 LNMX 10	24	3	100	25	15	0,389			
LN099	○	D20 d20 Z02 L120 LNMX 10	20	2	120	20	25	0,292			
LN100	○	D20 d20 Z03 L120 LNMX 10	20	3	120	20	25	0,285			
LN102	○	D25 d25 Z03 L120 LNMX 10	25	3	120	25	40	0,453			
LN103	○	D32 d32 Z04 L125 LNMX 10	32	4	125	32	40	0,706			
LN104	○	D40 d32 Z05 L130 LNMX 10	40	5	130	32	42	0,857			

KRLY ucuna uygundur. / Compatible with KRLY insert. / Kompatibel für KRLY WP

LNMX 1510

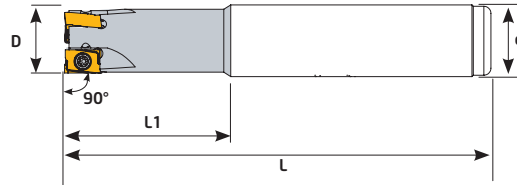

Ölçüler (mm) Dimensions(mm) Abmessungen (mm)			LNMX 1510	
L	S	A		
15	10	10		

Sipariş Kodu Order Code Best.-Nr.	Stok/Stock/Lager	Ürün Kodu Product Code Produkt-Code	Ölçüler (mm) Dimensions(mm) Abmessungen (mm)						Kullanılan Uç Insert WSP	Sıkma Civatası Clamp Screw Torx-Schraube	Anahtar Torx Key Torx-Schlüssel
			D	Z	L	d	L1				
S361	●	D32 d32 Z02 L150 LNMX 15	32	2	150	32	50	0,885			
S362	●	D40 d32 Z03 L150 LNMX 15	40	3	150	32	50	0,966			

KRLY ucuna uygundur. / Compatible with KRLY insert. / Kompatibel für KRLY WP



WNGX 0403

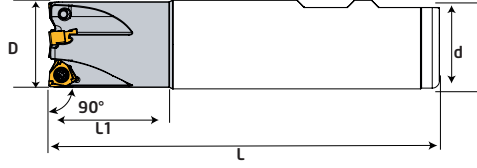

Ölçüler (mm)
Dimensions (mm)
Abmessungen (mm)

l	d	s
4,3	7	3,46

WNGX 0403

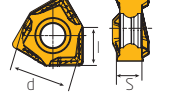

Sipariş Kodu Order Code Best.-Nr.	Stok/Stock/Lager	Ürün Kodu Product Code Produkt-Code	Ölçüler (mm) Dimensions (mm) Abmessungen (mm)					Kullanılan Uç Insert WSP	Sıkma Civatası Clamp Screw Torx-Schraube	Anahtar Torx Key Torx-Schlüssel	
			D	Z	L	d	L1				kg
S944	●	D20 d20 Z03 L110 WNGX 04	20	3	110	20	35	0,246	WNGX 0403 KRLY	TC060 M2,5x5,5	T8
S945	●	D25 d25 Z04 L110 WNGX 04	25	4	110	25	35	0,380			
S946	●	D32 d32 Z05 L110 WNGX 04	32	5	110	32	35	0,642			

KRLY ucuna uygundur. / Compatible with KRLY insert. / Kompatible für KRLY WP

XNEX 0403

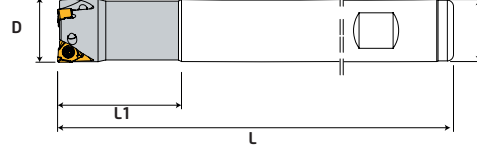

Ölçüler (mm)
Dimensions (mm)
Abmessungen (mm)

l	s
4	3,31

XNEX 0403

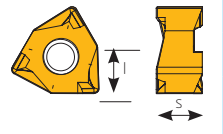

Sipariş Kodu Order Code Best.-Nr.	Stok/Stock/Lager	Ürün Kodu Product Code Produkt-Code	Ölçüler (mm) Dimensions (mm) Abmessungen (mm)					Kullanılan Uç Insert WSP	Sıkma Civatası Clamp Screw Torx-Schraube	Anahtar Torx Key Torx-Schlüssel	
			D	Z	L	d	L1				kg
S195	●	D20 d20 Z03 L150 XNEX 04	20	3	150	20	40	0,344	XNEX 0403 SCO	TC061 M2,5x7	T8
S196	●	D21 d20 Z03 L150 XNEX 04	21	3	150	20	40	0,348			
S198	●	D26 d25 Z04 L150 XNEX 04	26	4	150	25	40	0,535			

SCO ucuna uygundur. / Compatible with SCO insert. / Kompatible für SCO WP

WNGX 0806

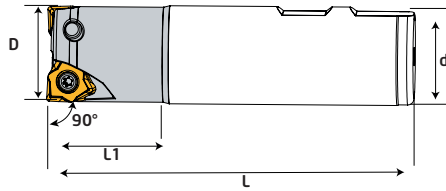

Ölçüler (mm)
Dimensions (mm)
Abmessungen (mm)

l	d	s
8,2	13	6,4

WNGX 0806

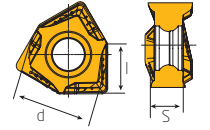

Sipariş Kodu Order Code Best.-Nr.	Stok/Stock/Lager	Ürün Kodu Product Code Produkt-Code	Ölçüler (mm) Dimensions (mm) Abmessungen (mm)					Kullanılan Uç Insert WSP	Sıkma Civatası Clamp Screw Torx-Schraube	Anahtar Torx Key Torx-Schlüssel	
			D	Z	L	d	L1				kg
S949	●	D40 d32 Z03 L120 WNGX 08	40	3	120	32	40	0,784	WNGX 0806 KRLY	TC083 M5X12	T20

KRLY ucuna uygundur. / Compatible with KRLY insert. / Kompatible für KRLY WP

● Stokta/ In Stock/ Lager ○ Sınırlı Stok/ Limited Stock/ Begrenzte Lagerhaltung

Kalite için Teknik Çözüm | Technical Solution For Quality



www.teknikcuttingtools.com

LNMT 0804

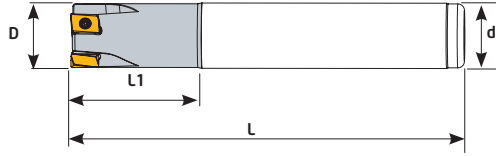

Ölçüler (mm) Dimensions(mm) Abmessungen (mm)			LNMT 0804	
L	S	A		
8,59	4,24	7,43		

Sipariş Kodu Order Code Best.-Nr.	Stok/Stock/Lager	Ürün Kodu Product Code Produkt-Code	Ölçüler (mm) Dimensions(mm) Abmessungen (mm)						Kullanılan Uç Insert WSP	Sıkma Civatası Clamp Screw Torx-Schraube	Anahtar Torx Key Torx-Schlüssel
			D	Z	L	d	L1				
S298	●	D16 d16 Z02 L120 LNMT 08	16	2	120	16	40	0,206			
S299	●	D20 d20 Z03 L120 LNMT 08	20	3	120	20	40	0,313			
S300	●	D25 d25 Z04 L120 LNMT 08	25	4	120	25	40	0,477			
S300-1	●	D32 d32 Z05 L120 LNMT 08	32	5	120	32	40	0,775			
S301	●	D16 d16 Z02 L150 LNMT 08	16	2	150	16	40	0,256			
S302	●	D20 d20 Z03 L150 LNMT 08	20	3	150	20	40	0,391			
S303	●	D25 d25 Z04 L150 LNMT 08	25	4	150	25	40	0,601			
S303-1	●	D32 d32 Z05 L150 LNMT 08	32	5	150	32	40	0,978			

ISCR ucuna uygundur. / Compatible with ISCR insert. / Kompatibel für ISCR WP

WNMU 0403

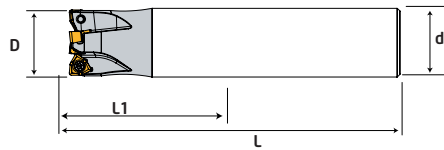

Ölçüler (mm) Dimensions(mm) Abmessungen (mm)			WNMU 0403	
l	d	s		
4,2	6,7	3,5		

Sipariş Kodu Order Code Best.-Nr.	Stok/Stock/Lager	Ürün Kodu Product Code Produkt-Code	Ölçüler (mm) Dimensions(mm) Abmessungen (mm)						Kullanılan Uç Insert WSP	Sıkma Civatası Clamp Screw Torx-Schraube	Anahtar Torx Key Torx-Schlüssel
			D	Z	L	d	L1				
S457	●	D20 d20 Z03 L120 WNMU 04	20	3	120	20	25	0,290			
S458	●	D25 d25 Z04 L120 WNMU 04	25	4	120	25	30	0,466			
S459	●	D32 d32 Z04 L120 WNMU 04	32	4	120	32	35	0,776			

ISCR ucuna uygundur. / Compatible with ISCR insert. / Kompatibel für ISCR WP



LOEX 0804

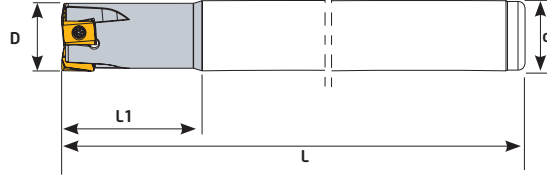

Ölçüler (mm) Dimensions(mm) Abmessungen (mm)		LOEX 0804	
L	s		
9,3	4,4		

Sipariş Kodu Order Code Best.-Nr.	Stok/Stock/Lager	Ürün Kodu Product Code Produkt-Code	Ölçüler (mm) Dimensions(mm) Abmessungen (mm)							Kullanılan Uç Insert WSP	Sıkma Civatası Clamp Screw Torx-Schraube	Anahtar Torx Key Torx-Schlüssel
			D	Z	L	d	L1	kg				
S295	●	D20 d20 Z03 L150 LOEX 08	20	3	150	20	40	0,384				
S296	●	D25 d25 Z04 L150 LOEX 08	25	4	150	25	40	0,604				

SCO ucuna uygundur. / Compatible with SCO insert. / Kompatible für SCO WP

LNHU 0904

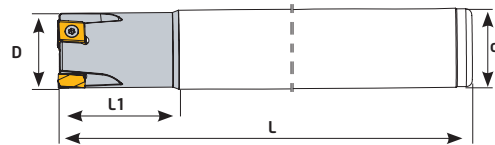

Ölçüler (mm) Dimensions(mm) Abmessungen (mm)			LNHU 0904	
L	L1	S		
8	9	3,5		

Sipariş Kodu Order Code Best.-Nr.	Stok/Stock/Lager	Ürün Kodu Product Code Produkt-Code	Ölçüler (mm) Dimensions(mm) Abmessungen (mm)							Kullanılan Uç Insert WSP	Sıkma Civatası Clamp Screw Torx-Schraube	Anahtar Torx Key Torx-Schlüssel
			D	Z	L	d	L1	kg				
S328	●	D25 d25 Z03 L150 LNHU 09	25	3	150	25	40	0,599				
S329	●	D32 d32 Z04 L150 LNHU 09	32	4	150	32	40	0,972				

WLTR ucuna uygundur. / Compatible with WLTR insert. / Kompatible für WLTR WP

LNMX 0603

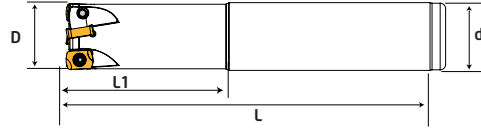

Ölçüler (mm) Dimensions(mm) Abmessungen (mm)			LNMX 0603	
L	S	A		
10	6,8	3,6		

Sipariş Kodu Order Code Best.-Nr.	Stok/Stok/Lager	Ürün Kodu Product Code Produkt-Code	Ölçüler (mm) Dimensions(mm) Abmessungen (mm)							Kullanılan Uç Insert WSP	Sıkma Civatası Clamp Screw Torx-Schraube	Anahtar Torx Key Torx-Schlüssel
			D	Z	L	d	L1					
S284	●	D16 d16 Z02 L110 LNMX 06	16	2	110	16	30	0,172				
S285	●	D20 d20 Z03 L130 LNMX 06	20	3	130	20	50	0,325				
S286	●	D25 d25 Z04 L140 LNMX 06	25	4	140	25	60	0,552				
S287	●	D32 d32 Z05 L150 LNMX 06	32	5	150	32	70	1,516				

KRLY ucuna uygundur. / Compatible with KRLY insert. / Kompatibel für KRLY WP

BLMP 0603

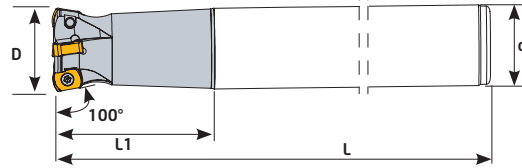

Ölçüler (mm) Dimensions(mm) Abmessungen (mm)			BLMP 0603	
d	l	s		
6,39	9	3,73		

Sipariş Kodu Order Code Best.-Nr.	Stok/Stok/Lager	Ürün Kodu Product Code Produkt-Code	Ölçüler (mm) Dimensions(mm) Abmessungen (mm)							Kullanılan Uç Insert WSP	Sıkma Civatası Clamp Screw Torx-Schraube	Anahtar Torx Key Torx-Schlüssel
			D	Z	L	d	L1					
S479	●	D16 d16 Z02 L150 BLMP 06	16	2	150	16	40	0,235				
S478	●	D17 d16 Z02 L150 BLMP 06	17	2	150	16	40	0,244				
S481	●	D20 d20 Z03 L150 BLMP 06	20	3	150	20	40	0,335				
S483	●	D25 d20 Z04 L150 BLMP 06	25	4	150	20	30	0,28				
S480	●	D21 d20 Z03 L200 BLMP 06	21	3	200	20	40	0,52				
S482	●	D26 d25 Z04 L200 BLMP 06	26	4	200	25	40	0,771				

TGTC ucuna uygundur. / Compatible with TGTC insert. / Kompatibel für TGTC WP



LOGU 0303

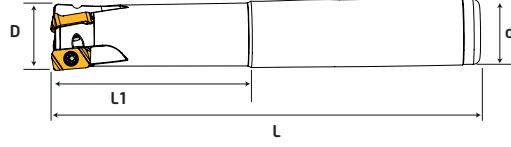

Ölçüler (mm) Dimensions(mm) Abmessungen (mm)			LOGU 0303
L	S	A	
11.8	4,9	6.2	

Sipariş Kodu Order Code Best.-Nr.	Stok/Stock/Lager	Ürün Kodu Product Code Produkt-Code	Ölçüler (mm) Dimensions(mm) Abmessungen (mm)						Kullanılan Uç Insert WSP	Sıkma Civatası Clamp Screw Torx-Schraube	Anahtar Torx Key Torx-Schlüssel
			D	Z	L	d	L1				
S677	●	D16 d16 Z02 L150 LOGU 03	16	2	150	16	50	0,219			
S678	●	D20 d20 Z03 L150 LOGU 03	20	3	150	20	60	0,356			
S679	●	D21 d20 Z03 L150 LOGU 03	21	3	150	20	60	0,365			
S680	●	D25 d25 Z04 L150 LOGU 03	25	4	150	25	60	0,579			

KYCR ucuna uygundur. / Compatible with KYCR insert. / Kompatible für KYCR WP

LNMU 0303

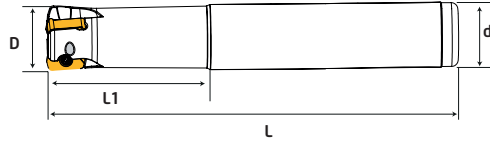
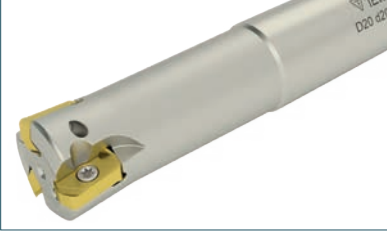

Ölçüler (mm) Dimensions(mm) Abmessungen (mm)			LNMU 0303
L	S	A	
11.8	4,1	6	

Sipariş Kodu Order Code Best.-Nr.	Stok/Stock/Lager	Ürün Kodu Product Code Produkt-Code	Ölçüler (mm) Dimensions(mm) Abmessungen (mm)						Kullanılan Uç Insert WSP	Sıkma Civatası Clamp Screw Torx-Schraube	Anahtar Torx Key Torx-Schlüssel
			D	Z	L	d	L1				
S671	●	D16 d16 Z02 L150 LNMU 03	16	2	150	16	50	0,233			
S672	●	D17 d16 Z02 L150 LNMU 03	17	2	150	16	40	0,241			
S673	●	D20 d20 Z03 L150 LNMU 03	20	3	150	20	50	0,381			
S674	●	D21 d20 Z03 L150 LNMU 03	21	3	150	20	50	0,389			
S675	●	D25 d25 Z04 L150 LNMU 03	25	4	150	25	60	0,589			

TNGLY - OKE ucuna uygundur. / Compatible with TNGLY - OKE insert. / Kompatible für TNGLY - OKE WP

ENMX 0604



Ölçüler (mm) Dimensions(mm) Abmessungen (mm)		ENMX 0604	
d	s		
6,30	4,11		

Sipariş Kodu Order Code Best.-Nr.	Stok/Stock/Lager	Ürün Kodu Product Code Produkt-Code	Ölçüler (mm) Dimensions(mm) Abmessungen (mm)							Kullanılan Uç Insert WSP	Sıkma Civatası Clamp Screw Torx-Schraube	Anahtar Torx Key Torx-Schlüssel
			D	Z	L	d	L1					
S105	●	D16 d16 Z02 L100 ENMX 06	16	2	100	16	30	0,146				
S106	●	D16 d16 Z02 L150 ENMX 06	16	2	150	16	50	0,228				
S107	●	D17 d16 Z02 L150 ENMX 06	17	2	150	16	20	0,242				
S108	●	D20 d20 Z03 L130 ENMX 06	20	3	130	20	50	0,316				
S109	●	D20 d20 Z03 L160 ENMX 06	20	3	160	20	80	0,382				
S110	●	D21 d20 Z03 L150 ENMX 06	21	3	150	20	20	0,391				
S111	●	D25 d25 Z04 L140 ENMX 06	25	4	140	25	60	0,538				
S112	●	D25 d25 Z04 L180 ENMX 06	25	4	180	25	80	0,696				
S113	●	D26 d25 Z04 L150 ENMX 06	26	4	150	25	30	0,612				
S114	●	D32 d32 Z05 L150 ENMX 06	32	5	150	32	70	0,963				
S115	●	D32 d32 Z05 L200 ENMX 06	32	5	200	32	70	0,963				

YG1 ucuna uygundur. / Compatible with YG1 insert. / Kompatible für YG1 WP

ENMX 0905



Ölçüler (mm) Dimensions(mm) Abmessungen (mm)		ENMX 0905	
d	s		
9	5,4		

Sipariş Kodu Order Code Best.-Nr.	Stok/Stock/Lager	Ürün Kodu Product Code Produkt-Code	Ölçüler (mm) Dimensions(mm) Abmessungen (mm)							Kullanılan Uç Insert WSP	Sıkma Civatası Clamp Screw Torx-Schraube	Anahtar Torx Key Torx-Schlüssel
			D	Z	L	d	L1					
S934	●	D25 d25 Z02 L150 ENMX 09	25	2	150	25	70	0,576				
S935	●	D32 d32 Z03 L160 ENMX 09	32	3	160	32	70	1,015				
S936	●	D40 d32 Z05 L180 ENMX 09	40	5	180	32	40	1,308				

YG1 ucuna uygundur. / Compatible with YG1 insert. / Kompatible für YG1 WP



SDMT 09T3

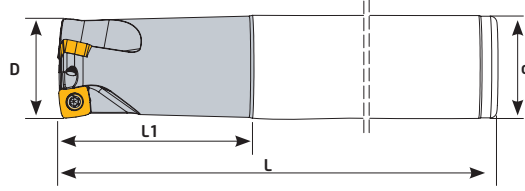

Ölçüler (mm) Dimensions(mm) Abmessungen (mm)		SDMT 09T3	
L	S		
9,52	3,97		

Sipariş Kodu Order Code Best.-Nr.	Stok/Stock/Lager	Ürün Kodu Product Code Produkt-Code	Ölçüler (mm) Dimensions(mm) Abmessungen (mm)						Kullanılan Uç Insert WSP	Sıkma Cıvatası Clamp Screw Torx-Schraube	Anahtar Torx Key Torx-Schlüssel
			D	Z	L	d	L1	kg			
S395	●	D25 d25 Z02 L150 SDMT 09	25	2	150	25	60	0,573	SDMT 09T3 ZCC	TC067 M3,5x8,5	T15
S396	●	D32 d32 Z03 L150 SDMT 09	32	3	150	32	60	0,934			

ZCC ucuna uygundur. / Compatible with ZCC insert. / Kompatible für ZCC WP

WNMX 0603

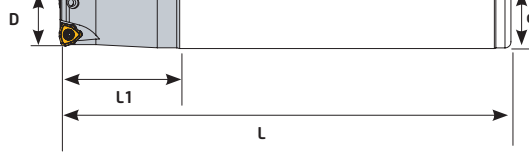
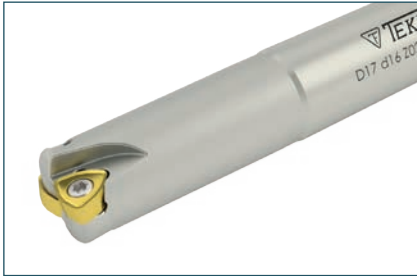

Ölçüler (mm) Dimensions(mm) Abmessungen (mm)			WNMX 0603	
D	I	S		
6,35	4,28	3,18		

Sipariş Kodu Order Code Best.-Nr.	Stok/Stock/Lager	Ürün Kodu Product Code Produkt-Code	Ölçüler (mm) Dimensions(mm) Abmessungen (mm)						Kullanılan Uç Insert WSP	Sıkma Cıvatası Clamp Screw Torx-Schraube	Anahtar Torx Key Torx-Schlüssel
			D	Z	L	d	L1	kg			
S898	●	D16 d16 Z02 L150 WNMX 06	16	2	150	16	40	0,241	WNMX 0603 KRLY	TC060 M2,5x5,5	T8
S899	●	D20 d20 Z02 L150 WNMX 06	20	2	150	20	40	0,378			
S903	●	D17 d16 Z02 L150 WNMX 06	17	2	150	16	40	0,240			
S904	●	D21 d20 Z02 L150 WNMX 06	21	2	150	20	40	0,379			
S905	●	D25 d25 Z03 L150 WNMX 06	25	3	150	25	60	0,578			
S906	●	D26 d25 Z04 L150 WNMX 06	26	4	150	25	60	0,582			

KRLY ucuna uygundur. / Compatible with KRLY insert. / Kompatible für KRLY WP

● Stokta/ In Stock/ Lager ○ Sınırlı Stok/ Limited Stock/ Begrenzte Lagerhaltung

Kalite için Teknik Çözüm | Technical Solution For Quality

BROTECH

TEKNİK
Cutting Tools

www.teknikcuttingtools.com

97

WNMX 09T3

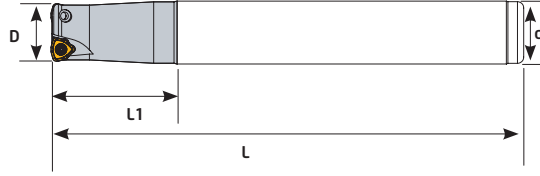

Ölçüler (mm) Dimensions(mm) Abmessungen (mm)			WNMX 09T3	
D	I	S		
9,52	6,8	3,97		

Sipariş Kodu Order Code Best.-Nr.	Stok/Stock/Lager	Ürün Kodu Product Code Produkt-Code	Ölçüler (mm) Dimensions(mm) Abmessungen (mm)						Kullanılan Uç Insert WSP	Sıkma Cıvatası Clamp Screw Torx-Schraube	Anahtar Torx Key Torx-Schlüssel
			D	Z	L	d	L1	kg			
S802	●	D25 d25 Z02 L150 WNMX 09	25	2	150	25	60	0,563			
S803	●	D26 d25 Z02 L140 WNMX 09	26	2	140	25	60	0,477			
S804	●	D30 d25 Z03 L150 WNMX 09	30	3	150	25	60	0,590			
S805	●	D32 d32 Z03 L150 WNMX 09	32	3	150	32	70	0,841			
S806	●	D33 d32 Z03 L150 WNMX 09	33	3	150	32	70	0,854			
S807	●	D40 d32 Z04 L150 WNMX 09	40	4	150	32	60	0,974			

KRLY ucuna uygundur. / Compatible with KRLY insert. / Kompatible für KRLY WP

WNMX 1305

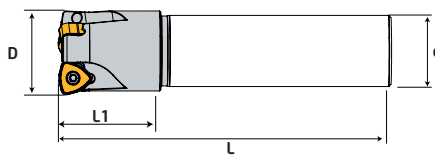

Ölçüler (mm) Dimensions(mm) Abmessungen (mm)		WNMX 1305	
d	s		
12,7	5,56		

Sipariş Kodu Order Code Best.-Nr.	Stok/Stock/Lager	Ürün Kodu Product Code Produkt-Code	Ölçüler (mm) Dimensions(mm) Abmessungen (mm)						Kullanılan Uç Insert WSP	Sıkma Cıvatası Clamp Screw Torx-Schraube	Anahtar Torx Key Torx-Schlüssel
			D	Z	L	d	L1	kg			
S800	●	D32 d32 Z02 L120 WNMX 13	32	2	120	32	70	0,933			
S801	●	D40 d32 Z03 L150 WNMX 13	40	3	150	32	50	1,069			

KRLY ucuna uygundur. / Compatible with KRLY insert. / Kompatible für KRLY WP



SPMG 0502 - 0602 - 07T3 - 0904

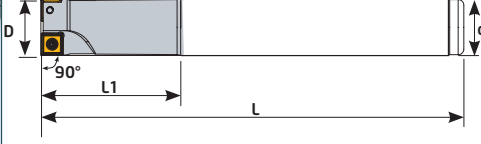
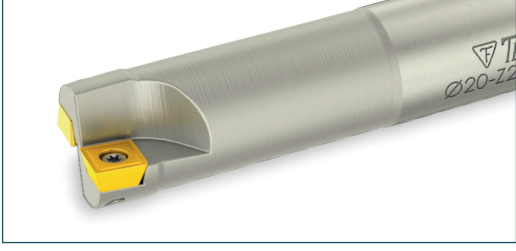

Ölçüler (mm) Dimensions(mm) Abmessungen (mm)		SPMG 0502
L	s	
5	2,38	SPMG 0602
6		
Ölçüler (mm) Dimensions(mm) Abmessungen (mm)		SPMG 07T3
L	s	
7,94	3,97	SPMG 0904
9,8		

Sipariş Kodu Order Code Best.-Nr.	Stok/Stock/Lager	Ürün Kodu Product Code Produkt-Code	Ölçüler (mm) Dimensions(mm) Abmessungen (mm)						Kullanılan Uç Insert WSP	Sıkma Cıvatası Clamp Screw Torx-Schraube	Anahtar Torx Key Torx-Schlüssel
			D	Z	L	d	L1	KG			
S810	●	D013 d14 Z02 L120 SPMG 05	13	2	120	14	40	0,147	SPMG 0502 TGTC	TC058 M2x4,2	T6
S812	●	D13,5 d14 Z02 L120 SPMG 05	13,5	2	120	14	40	0,149			
S814	●	D014 d14 Z02 L120 SPMG 06	14	2	120	14	40	0,148	SPMG 0602 TGTC	TC059 M2,2x5	T7
S818	●	D015 d16 Z02 L120 SPMG 06	15	2	120	16	40	0,186			
S822	●	D016 d16 Z02 L120 SPMG 06	16	2	120	16	40	0,194	SPMG 07T3 TGTC	TC063 M2,5x7	T8
S824	●	D020 d20 Z02 L150 SPMG 07	20	2	150	20	50	0,198			
S826	●	D20,5 d20 Z02 L120 SPMG 07	20,5	2	120	20	50	0,290	SPMG 0904 TGTC	TC067 M3,5x8,5	T15
S828	●	D025 d25 Z02 L150 SPMG 09	25	2	150	25	50	0,567			
S830	●	D032 d32 Z03 L150 SPMG 09	32	3	150	32	40	0,908			

TGTC ucuna uygundur. / Compatible with TGTC insert. / Kompatibel für TGTC WP

VCGT 1604

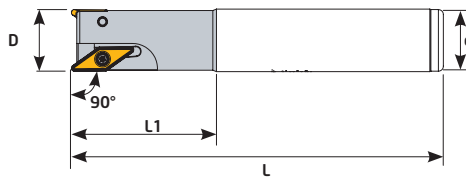
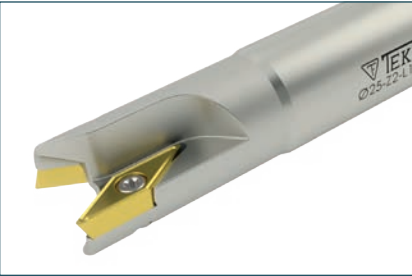

Ölçüler (mm) Dimensions(mm) Abmessungen (mm)		VCGT 1604
L	S	
16,6	4,76	

Sipariş Kodu Order Code Best.-Nr.	Stok/Stock/Lager	Ürün Kodu Product Code Produkt-Code	Ölçüler (mm) Dimensions(mm) Abmessungen (mm)						Kullanılan Uç Insert WSP	Sıkma Cıvatası Clamp Screw Torx-Schraube	Anahtar Torx Key Torx-Schlüssel
			D	Z	L	d	L1	KG			
S710	●	D25 d25 Z02 L150 VCGT 16	25	2	150	25	50	0,518	VCGT 1604 ISO	TC074 M4x10	T15
S712	●	D32 d32 Z02 L150 VCGT 16	32	2	150	32	60	0,852			
S714	●	D40 d32 Z03 L150 VCGT 16	40	3	150	32	60	0,951			
S718	●	D25 d25 Z02 L200 VCGT 16	25	2	200	25	60	0,730			
S720	●	D32 d32 Z02 L200 VCGT 16	32	2	200	32	60	1,225			
S724	●	D25 d25 Z02 L250 VCGT 16	25	2	250	25	60	0,920			
S726	●	D32 d32 Z02 L250 VCGT 16	32	2	250	32	60	1,250			

● Stokta/In Stock/Lager ○ Sınırlı Stok/Limited Stock/Begrenzte Lagerhaltung

Kalite için Teknik Çözüm | Technical Solution For Quality



www.teknikcuttingtools.com

F75° APXT 1003

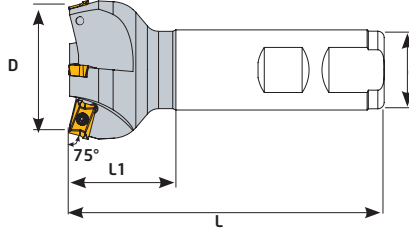

Ölçüler (mm) Dimensions(mm) Abmessungen (mm)		APXT 1003	
L	s		
10,5	3,52		

Sipariş Kodu Order Code Best.-Nr.	Stok/Stock/Lager	Ürün Kodu Product Code Produkt-Code	Ölçüler (mm) Dimensions(mm) Abmessungen (mm)							Kullanılan Uç Insert WSP	Sıkma Cıvatası Clamp Screw Torx-Schraube	Anahtar Torx Key Torx-Schlüssel
			D	Z	L	d	L1	⊗				
S344	●	D32 d25 Z03 L100 APKT 10	32	3	100	25	35	0,413	APKT 1003 KRLY	TC060 M2,5x5,5	T8	
S346	●	D40 d25 Z04 L100 APKT 10	40	4	100	25	35	0,494				
S348	●	D45 d25 Z04 L100 APKT 10	45	4	100	25	35	0,535				
S350	●	D50 d25 Z05 L100 APKT 10	50	5	100	25	35	0,583				

KRLY ucuna uygundur. / Compatible with KRLY insert. / Kompatible für KRLY WP

Küre Uçlu Freze Indexable Ball Nose End Mill

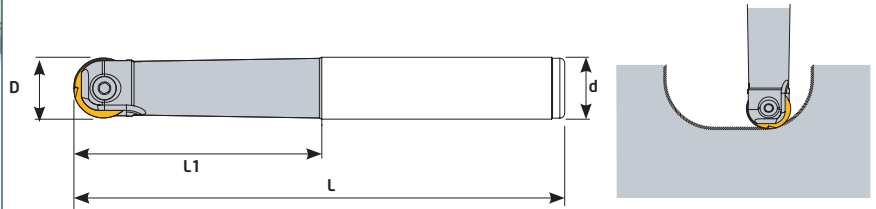
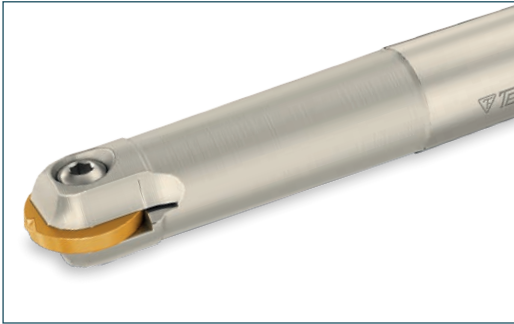

Sipariş Kodu Order Code Best.-Nr.	Stok/Stock/Lager	Ürün Kodu Product Code Produkt-Code	Ölçüler (mm) Dimensions(mm) Abmessungen (mm)						Kullanılan Uç Insert WSP	Sıkma Cıvatası Clamp Screw Torx-Schraube	Anahtar Torx Key Torx-Schlüssel
			D	L	d	L1	⊗				
S370	●	D08 d10 L130 P32-08	8	130	10	36	0,092	P32 08 WLTR	TC170 M3	T8	
S372	●	D10 d12 L130 P32-10	10	130	12	46	0,118	P32 10 WLTR	TC172 M4	T15	
S374	●	D12 d12 L150 P32-12	12	150	12	46	0,142	P32 12 WLTR	TC174 M5	T20	
S376	●	D16 d16 L175 P32-16	16	175	16	46	0,270	P32 16 WLTR	TC176 M5	T20	
S378	●	D20 d20 L200 P32-20	20	200	20	56	0,505	P32 20 WLTR	TC178 M5	T20	
S380	●	D25 d25 L200 P32-25	25	200	25	66	0,745	P32 25 WLTR	TC181 M6	3 Allen	
S381	●	D30 d32 L200 P32-30	30	200	32	66	1,148	P32 30 WLTR	TC184 M8	4 Allen	
S382	●	D32 d32 L200 P32-32	32	200	32	66	1,150	P32 32 WLTR	TC184 M8	4 Allen	

WLTR ucuna uygundur. / Compatible with WLTR insert. / Kompatible für WLTR WP



RDMT 1003-12T3

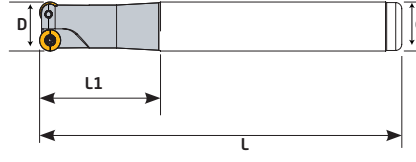

Ölçüler (mm) Dimensions(mm) Abmessungen (mm)		RDMT 1003 RDMT 12T3	
d	S		
10	3,18		
12	3,97		

Sipariş Kodu Order Code Best.-Nr.	Stok/Stock/Lager	Ürün Kodu Product Code Produkt-Code	Ölçüler (mm) Dimensions(mm) Abmessungen (mm)						Kullanılan Uç Insert WSP	Sıkma Cıvatası Clamp Screw Torx-Schraube	Anahtar Torx Key Torx-Schlüssel
			D	Z	L	d	L1	kg			
S771	●	D20 - Z02 L160 RDMT 10	20	2	160	20	60	0,359	RDMT1003 PLBT	TC071 M3,5x7	T15
S772	●	D20 - Z02 L220 RDMT 10	20	2	220	25	120	0,658			
S773	●	D25 - Z02 L220 RDMT 12	25	2	220	25	120	0,741			
S774	●	D25 - Z02 L230 RDMT 12	25	2	230	32	130	1,099			

PLBT ucuna uygundur. / Compatible with PLBT insert. / Kompatible für PLBT WP

RDMW 0501

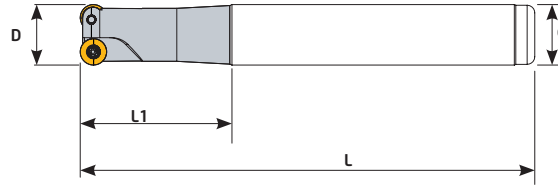
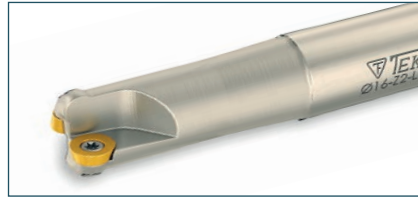

Ölçüler (mm) Dimensions(mm) Abmessungen (mm)		RDMW 0501	
L	S		
5	1,5		

Sipariş Kodu Order Code Best.-Nr.	Stok/Stock/Lager	Ürün Kodu Product Code Produkt-Code	Ölçüler (mm) Dimensions(mm) Abmessungen (mm)						Kullanılan Uç Insert WSP	Sıkma Cıvatası Clamp Screw Torx-Schraube	Anahtar Torx Key Torx-Schlüssel
			D	Z	L	d	L1	kg			
R080	●	D08 d10 Z01 L080 RDMW 05	8	1	80	10	27	0,053	RDMW 0501 TGTC	TC058 M2x4,2	T6
R082	●	D10 d12 Z02 L080 RDMW 05	10	2	80	12	34	0,076			
R083	●	D10 d12 Z02 L100 RDMW 05	10	2	100	12	40	0,085			
R084	●	D10 d12 Z02 L120 RDMW 05	10	2	120	12	45	0,111			
R086	●	D12 d12 Z02 L100 RDMW 05	12	2	100	12	40	0,099			
R088	●	D12 d12 Z02 L120 RDMW 05	12	2	120	12	45	0,118			

TGTC ucuna uygundur. / Compatible with TGTC insert. / Kompatible für TGTC WP

RDMW 0702

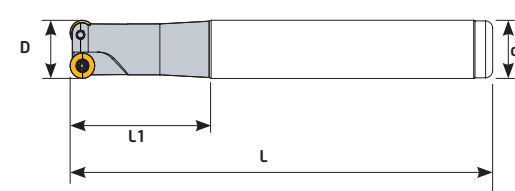
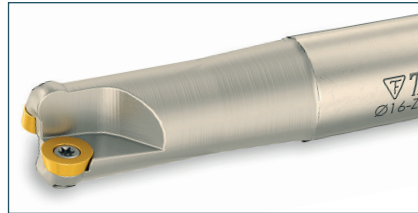

Ölçüler (mm) Dimensions(mm) Abmessungen (mm)		RDMW 0702	
L	S		
7	2,38		

Sipariş Kodu Order Code Best.-Nr.	Stok/Stock/Lager	Ürün Kodu Product Code Produkt-Code	Ölçüler (mm) Dimensions(mm) Abmessungen (mm)						Kullanılan Uç Insert WSP	Sıkma Cıvatası Clamp Screw Torx-Schraube	Anahtar Torx Key Torx-Schlüssel
			D	Z	L	d	L1	kg			
R136	●	D15 d16 Z02 L120 RDMW 07	15	2	120	16	40	0,187	RDMW 0702 TGTC	TC060 M2,5x5,5	T8
R138	●	D16 d16 Z02 L120 RDMW 07	16	2	120	16	40	0,148			
R142	●	D20 d20 Z03 L120 RDMW 07	20	3	120	20	45	0,278			
R143	●	D15 d16 Z02 L150 RDMW 07	15	2	150	16	50	0,228			
R144	●	D16 d16 Z02 L150 RDMW 07	16	2	150	16	60	0,230			
R148	●	D20 d20 Z03 L150 RDMW 07	20	3	150	20	60	0,354			

TGTC ucuna uygundur. / Compatible with TGTC insert. / Kompatible für TGTC WP

● Stokta/ In Stock/ Lager ○ Sınırlı Stok/ Limited Stock/ Begrenzte Lagerhaltung

Kalite için Teknik Çözüm | Technical Solution For Quality



www.teknikcuttingtools.com

RPMW 0803



Ölçüler (mm) Dimensions(mm) Abmessungen (mm)		RPMW 0803	
t	d		
3,18	8		

Sipariş Kodu Order Code Best.-Nr.	Stok/Stock/Lager	Ürün Kodu Product Code Produkt-Code	Ölçüler (mm) Dimensions(mm) Abmessungen (mm)							Kullanılan Uç Insert WSP	Sıkma Civatası Clamp Screw Torx-Schraube	Anahtar Torx Key Torx-Schlüssel
			D	Z	L	d	L1	kg				
R310	●	D16 d16 Z02 L130 RPMW 08	16	2	130	16	35	0,198	RPMW 0803 KRLY	TC065-1 M3x7	T8	
R311	●	D18 d16 Z02 L150 RPMW 08	18	2	150	16	35	0,240				
R312	●	D20 d20 Z03 L130 RPMW 08	20	3	130	20	35	0,316				
R313	●	D25 d25 Z04 L150 RPMW 08	25	4	150	25	35	0,591				

KRLY ucuna uygundur. / Compatible with KRLY insert. / Kompatible für KRLY WP

RPMW 10T3

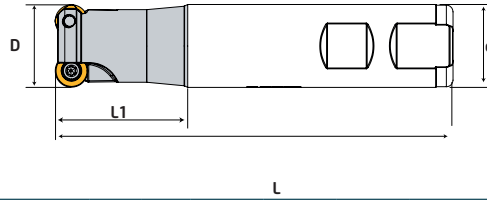
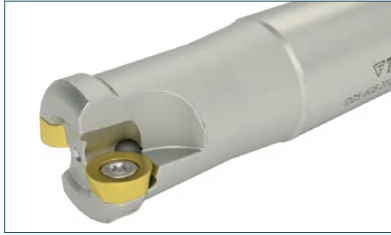

Ölçüler (mm) Dimensions(mm) Abmessungen (mm)		RPMW 10T3	
t	d		
3,97	10		

Sipariş Kodu Order Code Best.-Nr.	Stok/Stock/Lager	Ürün Kodu Product Code Produkt-Code	Ölçüler (mm) Dimensions(mm) Abmessungen (mm)							Kullanılan Uç Insert WSP	Sıkma Civatası Clamp Screw Torx-Schraube	Anahtar Torx Key Torx-Schlüssel
			D	Z	L	d	L1	kg				
R316	●	D20 d20 Z02 L120 RPMW 10	20	2	120	20	40	0,282	RPMW 10T3 KRLY	TC071 M3,5x7	T15	
R317	●	D25 d25 Z02 L120 RPMW 10	25	2	120	25	40	0,447				
R318	●	D25 d25 Z02 L160 RPMW 10	25	2	160	25	60	0,617				
R319	●	D32 d32 Z04 L125 RPMW 10	32	4	125	32	40	0,792				
R320	●	D32 d25 Z04 L200 RPMW 10	32	4	200	25	60	0,891				
R321	●	D40 d32 Z04 L150 RPMW 10	40	4	150	32	35	1,071				

KRLY ucuna uygundur. / Compatible with KRLY insert. / Kompatible für KRLY WP

RPMW 1204

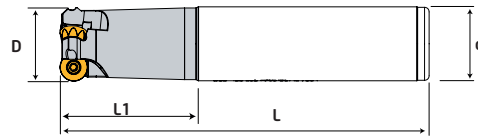
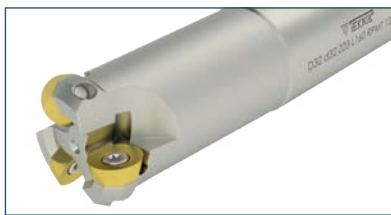

Ölçüler (mm) Dimensions(mm) Abmessungen (mm)		RPMW 1204	
t	d		
4,76	12		

Sipariş Kodu Order Code Best.-Nr.	Stok/Stock/Lager	Ürün Kodu Product Code Produkt-Code	Ölçüler (mm) Dimensions(mm) Abmessungen (mm)							Kullanılan Uç Insert WSP	Sıkma Civatası Clamp Screw Torx-Schraube	Anahtar Torx Key Torx-Schlüssel
			D	Z	L	d	L1	kg				
R325	●	D25 d25 Z02 L160 RPMW 12	25	2	160	25	60	0,607	RPMW 1204 KRLY	TC073 M4x7	T15	
R326	●	D32 d32 Z03 L160 RPMW 12	32	3	160	32	60	1,017				
R327	●	D40 d32 Z04 L150 RPMW 12	40	4	150	32	35	1,056				

KRLY ucuna uygundur. / Compatible with KRLY insert. / Kompatible für KRLY WP

● Stokta/In Stock/Lager ○ Sınırlı Stok/Limited Stock/Begrenzte Lagerhaltung



RDMT 1003

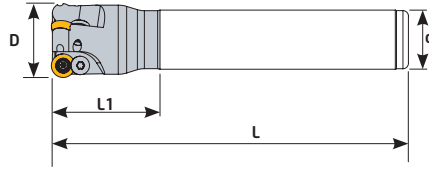
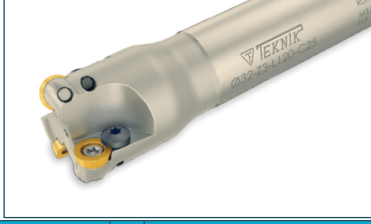

Ölçüler (mm) Dimensions (mm) Abmessungen (mm)		RDMT 1003	
L	S		
10	3,18		

Sipariş Kodu Order Code Best.-Nr.	Stok/Stock/Lager	Ürün Kodu Product Code Produkt-Code	Ölçüler (mm) Dimensions (mm) Abmessungen (mm)						Kullanılan Uç Insert WSP	Sıkma Cıvatası Clamp Screw Torx-Schraube	Baskı Cıvatası Locking Screw Verriegelungs Schraube	Anahtar Torx Key Torx-Schlüssel
			D	Z	L	d	L1	KG				
R190	●	D20 d20 Z02 L120 RDMT 10	20	2	120	20	55	0,265	RDMT 1003 ISO	TC071 M3,5x7	TC040 M3,5	T15
R192	●	D25 d25 Z02 L120 RDMT 10	25	2	120	25	50	0,435				
R193	●	D30 d25 Z03 L120 RDMT 10	30	3	120	25	40	0,468				
R194	●	D32 d25 Z03 L120 RDMT 10	32	3	120	25	40	0,484				
R196	●	D35 d25 Z03 L120 RDMT 10	35	3	120	25	45	0,508				
R198	●	D40 d25 Z04 L120 RDMT 10	40	4	120	25	45	0,558				
R200	●	D20 d20 Z02 L150 RDMT 10	20	2	150	20	60	0,336				
R202	●	D25 d25 Z02 L150 RDMT 10	25	2	150	25	60	0,544				
R203	●	D30 d25 Z03 L150 RDMT 10	30	3	150	25	40	0,586				
R204	●	D32 d32 Z03 L150 RDMT 10	32	3	150	32	45	0,898				
R206	●	D35 d32 Z03 L150 RDMT 10	35	3	150	32	45	0,923				
R208	●	D40 d32 Z04 L150 RDMT 10	40	4	150	32	45	0,967				
R210	●	D20 d20 Z02 L200 RDMT 10	20	2	200	20	80	0,477				
R212	●	D25 d25 Z02 L200 RDMT 10	25	2	200	25	70	0,747				
R213	●	D30 d25 Z03 L200 RDMT 10	30	3	200	25	40	0,789				
R214	●	D32 d32 Z03 L200 RDMT 10	32	3	200	32	45	1,273				
R216	●	D35 d32 Z03 L200 RDMT 10	35	3	200	32	45	1,227				
R218	●	D40 d32 Z04 L200 RDMT 10	40	4	200	32	45	1,281				

RDMT 12T3

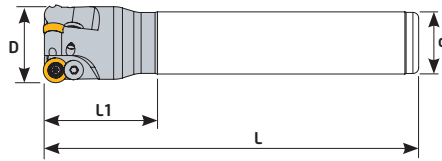

Ölçüler (mm) Dimensions (mm) Abmessungen (mm)		RDMT 12T3	
L	S		
12	3,97		

Sipariş Kodu Order Code Best.-Nr.	Stok/Stock/Lager	Ürün Kodu Product Code Produkt-Code	Ölçüler (mm) Dimensions (mm) Abmessungen (mm)						Kullanılan Uç Insert WSP	Sıkma Cıvatası Clamp Screw Torx-Schraube	Baskı Cıvatası Locking Screw Verriegelungs Schraube	Anahtar Torx Key Torx-Schlüssel
			D	Z	L	d	L1	KG				
R228	●	D25 d25 Z02 L120 RDMT 12	25	2	120	25	50	0,422	RDMT 12T3 ISO	TC067 M3,5x8,5	TC040 M3,5	T15
R229	●	D30 d25 Z02 L120 RDMT 12	30	2	120	25	40	0,456				
R230	●	D32 d25 Z03 L120 RDMT 12	32	3	120	25	40	0,473				
R232	●	D35 d25 Z03 L120 RDMT 12	35	3	120	25	40	0,485				
R234	●	D40 d25 Z03 L120 RDMT 12	40	3	120	25	40	0,513				
R236	●	D25 d25 Z02 L150 RDMT 12	25	2	150	25	60	0,539				
R237	●	D30 d25 Z02 L150 RDMT 12	30	2	150	25	55	0,536				
R238	●	D32 d32 Z03 L150 RDMT 12	32	3	150	32	45	0,876				
R240	●	D35 d32 Z03 L150 RDMT 12	35	3	150	32	45	0,900				
R242	●	D40 d32 Z03 L150 RDMT 12	40	3	150	32	45	0,956				
R244	●	D25 d25 Z02 L200 RDMT 12	25	2	200	25	70	0,740				
R245	●	D30 d25 Z02 L200 RDMT 12	30	2	200	25	55	0,784				
R246	●	D32 d32 Z03 L200 RDMT 12	32	3	200	32	45	1,201				
R248	●	D35 d32 Z03 L200 RDMT 12	35	3	200	32	45	1,226				
R250	●	D40 d32 Z03 L200 RDMT 12	40	3	200	32	45	1,287				
R255	●	D30 d25 Z02 L300 RDMT 12	30	2	300	25	55	1,168				
R256	●	D32 d32 Z03 L300 RDMT 12	32	3	300	32	70	1,829				
R258	●	D35 d32 Z03 L300 RDMT 12	35	3	300	32	45	1,855				
R260	●	D40 d32 Z03 L300 RDMT 12	40	3	300	32	45	1,995				

● Stokta/In Stock/Lager ○ Sınırlı Stok/Limited Stock/Begrenzte Lagerhaltung

Kalite için Teknik Çözüm | Technical Solution For Quality



www.teknikcuttingtools.com

103

TPKN 1103 - 1603 - 2204

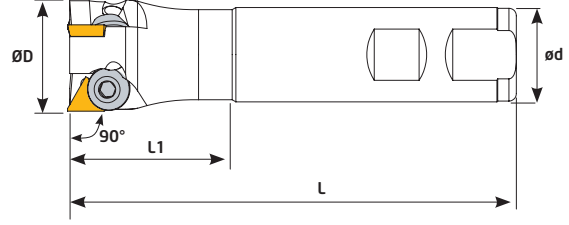
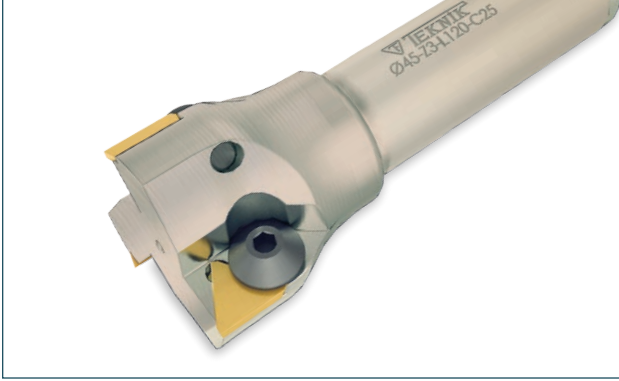

Ölçüler (mm) Dimensions(mm) Abmessungen (mm)		TPKN 1103	TPKN 2204
L	S		
11	3,18		
12,7			
22	4,76		

Sipariş Kodu Order Code Best.-Nr.	Stok/Stock/Lager	Ürün Kodu Product Code Produkt-Code	Ölçüler (mm) Dimensions(mm) Abmessungen (mm)						Kullanılan Uç Insert WSP	Baskı Civatası Locking Screw Verriegelungsschraub	Anahtar Allen Key Inbuss-Schlüssel
			ØD	Z	L	Ød	L1				
S116	●	D22 d20 Z02 L120 TPKN 11	22	2	120	20	45	0,301			3 Allen
S118	●	D25 d25 Z02 L120 TPKN 11	25	2	120	25	45	0,438			
S124	●	D32 d25 Z03 L120 TPKN 11	32	3	120	25	45	0,480			
S128	●	D35 d25 Z02 L120 TPKN 16	35	2	120	25	45	0,507			4 Allen
S130	●	D40 d25 Z03 L120 TPKN 16	40	3	120	25	45	0,552			
S132	●	D45 d25 Z03 L120 TPKN 16	45	3	120	25	45	0,606			
S134	●	D50 d32 Z03 L120 TPKN 22	50	3	120	32	55	0,896			5 Allen

TPKN 1103-1603-2204 ISO'dur. / TPKN 1103-1603-2204 is ISO. / Kompatible für ISO WP



Vidalı Takımları
Modular End Mill
Einschraubfräser



**Technical Solution
for Quality**



APXT 1003

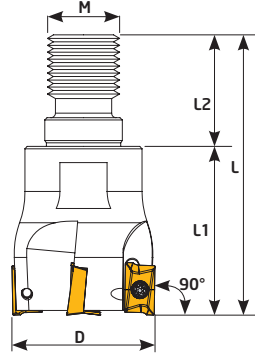

Ölçüler (mm) Dimensions(mm) Abmessungen (mm)		APXT 1003	
L	s		
10,5	3,52		

Sipariş Kodu Order Code Best.-Nr.	Stok/Stock/Lager	Ürün Kodu Product Code Produkt-Code	Ölçüler (mm) Dimensions(mm) Abmessungen (mm)							Kullanılan Uç Insert WSP	Sıkma Cıvatası Clamp Screw Torx-Schraube	Anahtar Torx Key Torx-Schlüssel
			D	Z	M	L	L1	L2	kg			
VT136	●	D16 Z02 M08 APXT 10	16	2	M08	41	25	16	0,050	APXT 1003 KRLY	TC060 M2,5x5,5	T8
VT138	●	D20 Z03 M10 APXT 10	20	3	M10	55	35	20	0,097			
VT140	●	D25 Z03 M12 APXT 10	25	3	M12	55	33	22	0,135			
VT143	●	D32 Z04 M16 APXT 10	32	4	M16	60	35,5	24,5	0,195			
VT146	●	D35 Z04 M16 APXT 10	35	4	M16	60	35,5	24,5	0,225			
VT148	●	D40 Z05 M16 APXT 10	40	5	M16	60	35,5	24,5	0,266			
VT150	●	D42 Z05 M16 APXT 10	42	5	M16	60	35,5	24,5	0,294			

KRLY ucuna uygundur. / Compatible with KRLY insert. / Kompatibel für KRLY WP

APKT 1604

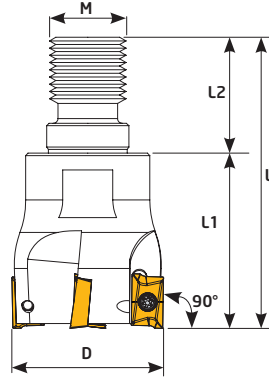

Ölçüler (mm) Dimensions(mm) Abmessungen (mm)		APKT 1604	
L	s		
16,4	4,76		

Sipariş Kodu Order Code Best.-Nr.	Stok/Stock/Lager	Ürün Kodu Product Code Produkt-Code	Ölçüler (mm) Dimensions(mm) Abmessungen (mm)							Kullanılan Uç Insert WSP	Sıkma Cıvatası Clamp Screw Torx-Schraube	Anahtar Torx Key Torx-Schlüssel
			D	Z	M	L	L1	L2	kg			
VT160	●	D25 Z02 M12 APKT 16	25	2	M12	55	33	22	0,107	APKT 1604 KRLY	TC074 M4x10	T15
VT163	●	D32 Z03 M16 APKT 16	32	3	M16	60	35,5	24,5	0,180			
VT166	●	D35 Z03 M16 APKT 16	35	3	M16	60	35,5	24,5	0,211			
VT168	●	D40 Z04 M16 APKT 16	40	4	M16	60	35,5	24,5	0,238			
VT170	●	D42 Z04 M16 APKT 16	42	4	M16	60	35,5	24,5	0,251			

KRLY ucuna uygundur. / Compatible with KRLY insert. / Kompatibel für KRLY WP



APMT 0903

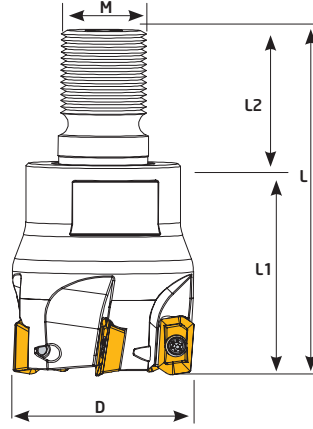

Ölçüler (mm) Dimensions(mm) Abmessungen (mm)			APMT 0903	
l	d	s		
9,4	3,6	6,21		

Sipariş Kodu Order Code Best.-Nr.	Stok/Stock/Lager	Ürün Kodu Product Code Produkt-Code	Ölçüler (mm) Dimensions(mm) Abmessungen (mm)							Kullanılan Uç Insert WSP	Sıkma Cıvatası Clamp Screw Torx-Schraube	Anahtar Torx Key Torx-Schlüssel
			D	Z	M	L	L1	L2	kg			
VT224	●	D16 Z02 M08 APMT 09	16	2	M08	41	25	16	0,040	APMT 0903 KRLY	TC060 M2,5x5,5	T8
VT225	●	D20 Z03 M10 APMT 09	20	3	M10	48	30	18	0,071			
VT226	●	D25 Z04 M12 APMT 09	25	4	M12	57	35	22	0,116			
VT227	●	D32 Z05 M16 APMT 09	32	5	M16	65,3	40	25,3	0,229			
VT228	●	D35 Z05 M16 APMT 09	35	5	M16	65,3	40	25,3	0,261			
VT229	●	D40 Z06 M16 APMT 09	40	6	M16	65,3	40	25,3	0,299			

KRLY ucuna uygundur. / Compatible with KRLY insert. / Kompatible für KRLY WP

ADMX 0702

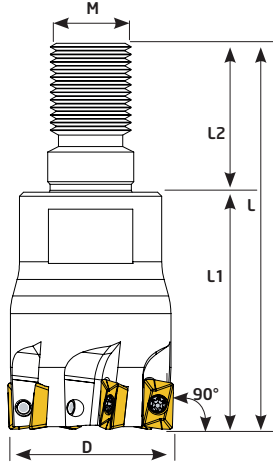

Ölçüler (mm) Dimensions(mm) Abmessungen (mm)		ADMX 0702	
L	S		
7,28	2,48		

Sipariş Kodu Order Code Best.-Nr.	Stok/Stock/Lager	Ürün Kodu Product Code Produkt-Code	Ölçüler (mm) Dimensions(mm) Abmessungen (mm)							Kullanılan Uç Insert WSP	Sıkma Cıvatası Clamp Screw Torx-Schraube	Anahtar Torx Key Torx-Schlüssel
			D	Z	M	L	L1	L2	kg			
VT200	○	D16 Z04 M08 ADMX 07	16	4	M08	41	23	18	0,041	ADMX 0702 PRMT	TC058 M2x4,2	T6
VT201	○	D20 Z05 M10 ADMX 07	20	5	M10	49	30	19	0,080			
VT203	○	D32 Z08 M16 ADMX 07	32	8	M16	66	43	23	0,235			

PRMT ucuna uygundur. / Compatible with PRMT insert. / Kompatible für PRMT WP

● Stokta/In Stock/Lager ○ Sınırlı Stok/Limited Stock/Begrenzte Lagerhaltung

Kalite için Teknik Çözüm | Technical Solution For Quality

BROTECH

TEKNİK
Cutting Tools

www.teknikcuttingtools.com

107

RDMT 1003

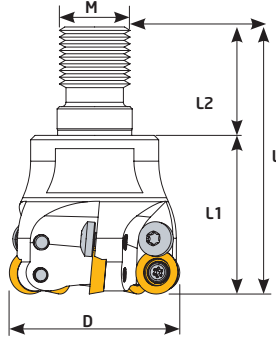

Ölçüler (mm) Dimensions(mm) Abmessungen (mm)		RDMT 1003	
d	S		
10	3,18		

Sipariş Kodu Order Code Best.-Nr.	Stok/Stock/Lager	Ürün Kodu Product Code Produkt-Code	Ölçüler (mm) Dimensions(mm) Abmessungen (mm)							Kullanılan Uç Insert WSP	Baskı Cıvatası Locking Screw Verriegelungs Schraube	Sıkma Cıvatası Clamp Screw Torx-Schraube	Anahtar Torx Key Torx-Schlüssel
			D	Z	M	L	L1	L2	ISO				
VT098	●	D20 Z02 M10 RDMT 10	20	2	M10	55	35	20	0,087	RDMT 1003 ISO	TC040 M3,5	TC067 M3,5x8,5	T15
VT100	●	D25 Z03 M12 RDMT 10	25	3	M12	55	33	22	0,114				
VT103	●	D32 Z03 M16 RDMT 10	32	3	M16	60	35,5	24,5	0,188				
VT106	●	D35 Z04 M16 RDMT 10	35	4	M16	60	35,5	24,5	0,201				
VT107	●	D35 Z05 M16 RDMT 10	35	5	M16	60	35,5	24,5	0,211				
VT108	●	D40 Z05 M16 RDMT 10	40	5	M16	60	35,5	24,5	0,241				
VT110	●	D42 Z05 M16 RDMT 10	42	5	M16	60	35,5	24,5	0,265				

RDMT 12T3

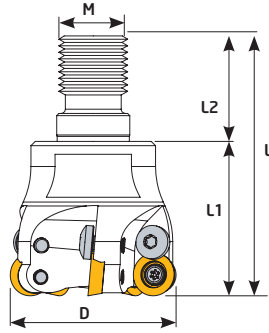
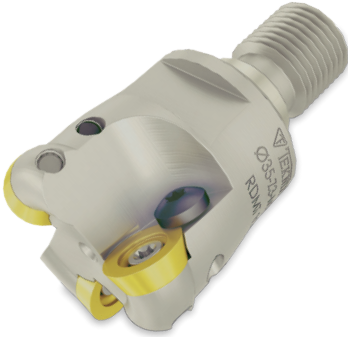

Ölçüler (mm) Dimensions(mm) Abmessungen (mm)		RDMT 12T3	
d	S		
12	3,97		

Sipariş Kodu Order Code Best.-Nr.	Stok/Stock/Lager	Ürün Kodu Product Code Produkt-Code	Ölçüler (mm) Dimensions(mm) Abmessungen (mm)							Kullanılan Uç Insert WSP	Baskı Cıvatası Locking Screw Verriegelungs Schraube	Sıkma Cıvatası Clamp Screw Torx-Schraube	Anahtar Torx Key Torx-Schlüssel
			D	Z	M	L	L1	L2	ISO				
VT120	●	D25 Z02 M12 RDMT 12	25	2	M12	55	33	22	0,106	RDMT 12T3 ISO	TC040 M3,5	TC067 M3,5x8,5	T15
VT123	●	D32 Z03 M16 RDMT 12	32	3	M16	60	35,5	24,5	0,177				
VT126	●	D35 Z03 M16 RDMT 12	35	3	M16	60	35,5	24,5	0,196				
VT128	●	D40 Z04 M16 RDMT 12	40	4	M16	60	35,5	24,5	0,230				
VT130	●	D42 Z04 M16 RDMT 12	42	4	M16	60	35,5	24,5	0,237				



RPMT 10

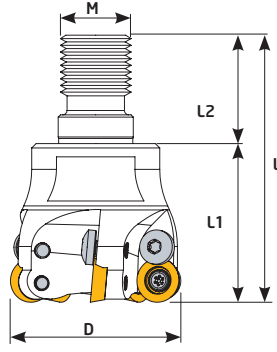

Ölçüler (mm) Dimensions(mm) Abmessungen (mm)		RPMT 10T3	
d	S		
10	3,97		

Sipariş Kodu Order Code Best.-Nr.	Stok/Stock/Lager	Ürün Kodu Product Code Produkt-Code	Ölçüler (mm) Dimensions(mm) Abmessungen (mm)							Kullanılan Uç Insert WSP	Baskı Cıvatası Locking Screw Verriegelungs Schraube	Sıkma Cıvatası Clamp Screw Torx-Schraube	Anahtar Torx Key Torx-Schlüssel
			D	Z	M	L	L1	L2	kg				
VT180	○	D25 Z03 M12 RPMT 10	25	3	M12	55	33	22	0,084	RPMT 10 MTSBSH	TC040 M3,5	TC067 M3,5x8,5	T15
VT182	○	D32 Z03 M16 RPMT 10	32	3	M16	68	36	24,5	0,189				

MTSBSH ucuna uygundur. / Compatible with MTSBSH insert. / Kompatible für MTSBSH WP

RPMT 12

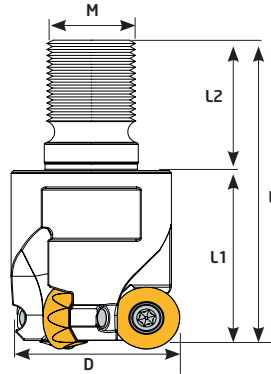

Ölçüler (mm) Dimensions(mm) Abmessungen (mm)		RPMT 1204	
d	S		
12	4,76		

Sipariş Kodu Order Code Best.-Nr.	Stok/Stock/Lager	Ürün Kodu Product Code Produkt-Code	Ölçüler (mm) Dimensions(mm) Abmessungen (mm)							Uç Insert WSP	Sıkma Cıvatası Clamp Screw Torx-Schraube	Anahtar Torx Key Torx-Schlüssel
			D	Z	M	L	L1	L2	kg			
VT174	○	D25 Z02 M12 RPMT 12	25	2	M12	55	33	22	0,109	RPMT 12 MTSBSH	TC067 M3,5x9	T15
VT176	○	D32 Z03 M16 RPMT 12	32	3	M16	60	34,7	25,3	0,164			

MTSBSH ucuna uygundur. / Compatible with MTSBSH insert. / Kompatible für MTSBSH WP

XNEX 0403

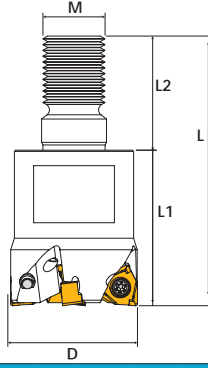

Ölçüler (mm) Dimensions(mm) Abmessungen (mm)		XNEX 0403	
l	s		
4	3,31		

Sipariş Kodu Order Code Best.-Nr.	Stok/Stock/Lager	Ürün Kodu Product Code Produkt-Code	Ölçüler (mm) Dimensions(mm) Abmessungen (mm)							Kullanılan Uç Insert WSP	Sıkma Civatası Clamp Screw Torx-Schraube	Anahtar Torx Key Torx-Schlüssel
			D	Z	M	L	L1	L2	Ⓢ			
VT245	●	D20 Z03 M10 XNEX 04	20	3	M10	46	28	18	0,073			
VT247	●	D25 Z04 M12 XNEX 04	25	4	M12	52	30	0,115				
VT249	●	D32 Z05 M16 XNEX 04	32	5	M16	65	40	0,253				

SCO ucuna uygundur. / Compatible with SCO insert. / Kompatible für SCO WP

EPMT 0603

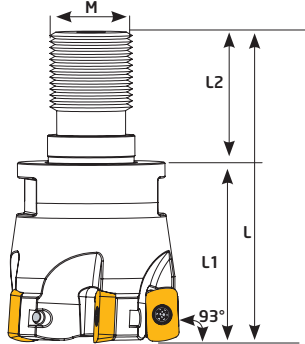

Ölçüler (mm) Dimensions(mm) Abmessungen (mm)		EPMT 0603	
l	s		
10	3,18		

Sipariş Kodu Order Code Best.-Nr.	Stok/Stock/Lager	Ürün Kodu Product Code Produkt-Code	Ölçüler (mm) Dimensions(mm) Abmessungen (mm)							Kullanılan Uç Insert WSP	Sıkma Civatası Clamp Screw Torx-Schraube	Anahtar Torx Key Torx-Schlüssel
			D	Z	M	L	L1	L2	Ⓢ			
VT230	●	D16 Z02 M08 EPMT 06	16	2	M08	41	16	25	0,040			
VT231	●	D20 Z03 M10 EPMT 06	20	3	M10	48	18	30	0,070			
VT232	●	D25 Z04 M12 EPMT 06	25	4	M12	55	20	35	0,110			
VT233	●	D32 Z05 M16 EPMT 06	32	5	M16	60	25,3	34,7	0,197			
VT234	●	D35 Z05 M16 EPMT 06	35	5	M16	60	25,3	34,7	0,224			
VT235	●	D40 Z06 M16 EPMT 06	40	6	M16	60	25,3	34,7	0,256			
VT236	●	D42 Z06 M16 EPMT 06	42	6	M16	65,3	25,3	40	0,300			

HTCH ucuna uygundur. / Compatible with HTCH insert. / Kompatible für HTCH WP



LNMX 0603

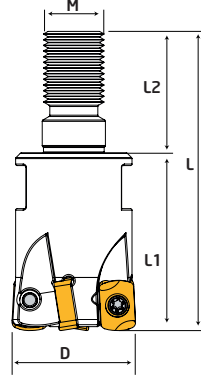

Ölçüler (mm) Dimensions(mm) Abmessungen (mm)			LNMX 0603	
L	S	A		
10	6,8	3,6		

Sipariş Kodu Order Code Best.-Nr.	Stok/Stock/Lager	Ürün Kodu Product Code Produkt-Code	Ölçüler (mm) Dimensions(mm) Abmessungen (mm)							Kullanılan Uç Insert WSP	Sıkma Cıvatası Clamp Screw Torx-Schraube	Anahtar Torx Key Torx-Schlüssel
			D	Z	M	L	L1	L2	kg			
VT152	●	D16 Z02 M08 LNMX 06	16	2	M08	42	25	17	0,031	LNMX 0603 KRLY	TC065-1 M3x7	T8
VT153	●	D20 Z03 M10 LNMX 06	20	3	M10	51	30	21	0,060			
VT154	●	D25 Z04 M12 LNMX 06	25	4	M12	59	35	24	0,120			
VT155	●	D32 Z05 M16 LNMX 06	32	5	M16	67	40	27	0,227			

KRLY ucuna uygundur. / Compatible with KRLY insert. / Kompatibel für KRLY WP

LNMU 0303

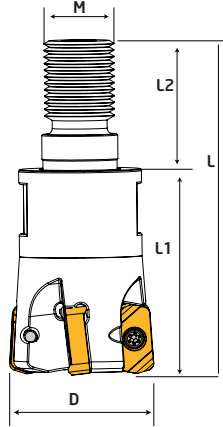

Ölçüler (mm) Dimensions(mm) Abmessungen (mm)			LNMU 0303	
L	S	A		
11.8	4,1	6		

Sipariş Kodu Order Code Best.-Nr.	Stok/Stock/Lager	Ürün Kodu Product Code Produkt-Code	Ölçüler (mm) Dimensions(mm) Abmessungen (mm)							Kullanılan Uç Insert WSP	Sıkma Cıvatası Clamp Screw Torx-Schraube	Anahtar Torx Key Torx-Schlüssel
			D	Z	M	L	L1	L2	kg			
VT300	●	D16 Z02 M08 LNMU 03	16	2	M08	42	25	17	0,029	LNMU 0303 TNGLY-OKE	TC063 M2,5x7	T8
VT302	●	D20 Z03 M10 LNMU 03	20	3	M10	49	30	19	0,061			
VT304	●	D25 Z04 M12 LNMU 03	25	4	M12	57	35	22	0,108			
VT305	●	D32 Z05 M16 LNMU 03	32	5	M16	63	40	23	0,227			
VT307	●	D40 Z06 M16 LNMU 03	40	6	M16	63	40	23	0,272			

TNGLY-OKE ucuna uygundur. / Compatible with TNGLY-OKE insert. / Kompatibel für TNGLY-OKE WP

BLMP 0603

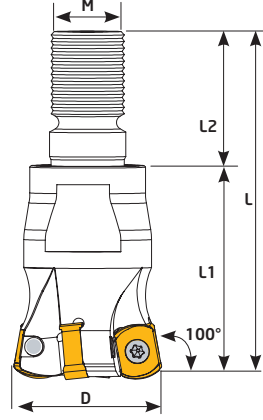

Ölçüler (mm) Dimensions(mm) Abmessungen (mm)			BLMP 0603	
d	l	s		
6,39	9	3,73		

Sipariş Kodu Order Code Best.-Nr.	Stok/Stock/Lager	Ürün Kodu Product Code Produkt-Code	Ölçüler (mm) Dimensions(mm) Abmessungen (mm)							Kullanılan Uç Insert WSP	Sıkma Cıvatası Clamp Screw Torx-Schraube	Anahtar Torx Key Torx-Schlüssel
			D	Z	M	L	L1	L2	kg			
VT190	●	D16 Z02 M08 BLMP 06	16	2	M08	41	25	16	0,044	BLMP 0603 TGTC	TC064 M3x6,5	T8
VT191	●	D20 Z03 M10 BLMP 06	20	3	M10	48	30	18	0,081			
VT192	●	D25 Z04 M12 BLMP 06	25	4	M12	57	35	22	0,119			
VT193	●	D32 Z05 M16 BLMP 06	32	5	M16	65	40	25	0,233			
VT194	●	D35 Z05 M16 BLMP 06	35	5	M16	65	40	25	0,240			
VT195	●	D40 Z06 M16 BLMP 06	40	6	M16	68	43	25	0,291			
VT196	●	D42 Z06 M16 BLMP 06	42	6	M16	68	43	25	0,313			

TGTC ucuna uygundur. / Compatible with TGTC insert. / Kompatible für TGTC WP

SDMT 09T3

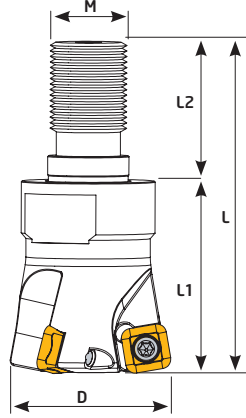

Ölçüler (mm) Dimensions(mm) Abmessungen (mm)		SDMT 09T3	
L	S		
9,52	3,97		









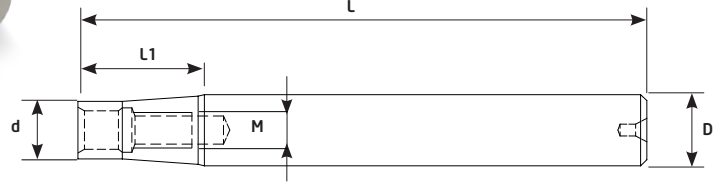

Sipariş Kodu Order Code Best.-Nr.	Stok/Stock/Lager	Ürün Kodu Product Code Produkt-Code	Ölçüler (mm) Dimensions(mm) Abmessungen (mm)							Kullanılan Uç Insert WSP	Sıkma Cıvatası Clamp Screw Torx-Schraube	Anahtar Torx Key Torx-Schlüssel
			D	Z	M	L	L1	L2	kg			
VT240	●	D32 Z03 M16 SDMT 09	32	3	M16	69	40	29	0,211	SDMT 09T3 ZCC	TC067 M3,5x8,5	T15
VT241	●	D35 Z03 M16 SDMT 09	35	3	M16	69	40	29	0,231			
VT242	●	D40 Z04 M16 SDMT 09	40	3	M16	69	40	29	0,253			

ZCC ucuna uygundur. / Compatible with ZCC insert. / Kompatible für ZCC WP



Vidalı Takım Tutucu
Modular End Mill Holder



Sipariş Kodu Order Code Best.-Nr.	Stok/Stock/Lager	Ürün Kodu Product Code Produkt-Code	Ölçüler (mm) Dimensions(mm) Abmessungen (mm)					
			D	d	L	L1	M	ISO
VT500	●	D15-L150 M08	15	12,7	150	30	M8	0,208
VT501	●	D15-L150 M08-IC 	15	12,7	150	30	M8	0,202
VT502	●	D16-L100 M08	16	14	100	30	M8	0,153
VT503	●	D16-L100 M08-IC 	16	14	100	30	M8	0,150
VT504	●	D16-L150 M08	16	14	150	30	M8	0,234
VT505	●	D16-L150 M08 -IC 	16	14	150	30	M8	0,230
VT506	●	D19-L150 M10	19	17,7	150	30	M10	0,329
VT507	●	D19-L150 M10-IC 	19	17,7	150	30	M10	0,324
VT508	●	D20-L100 M10	20	17,7	100	30	M10	0,238
VT509	●	D20-L100 M10-IC 	20	17,7	100	30	M10	0,235
VT510	●	D20-L150 M10	20	17,7	150	40	M10	0,357
VT511	●	D20-L150 M10-IC 	20	17,7	150	40	M10	0,354
VT512	●	D24-L150 M12	24	20,7	150	40	M12	0,508
VT513	●	D24-L150 M12-IC 	24	20,7	150	40	M12	0,502
VT514	●	D25-L150 M12	25	20,7	150	40	M12	0,546
VT515	●	D25-L150 M12-IC 	25	20,7	150	40	M12	0,542
VT516	●	D25-L200 M12	25	20,7	200	40	M12	0,680
VT517	●	D25-L200 M12-IC 	25	20,7	200	40	M12	0,675
VT518	●	D25-L250 M12	25	20,7	250	40	M12	0,700
VT519	●	D25-L250 M12-IC 	25	20,7	250	40	M12	0,695
VT520	●	D32-L170 M16	32	28,7	170	40	M16	0,790
VT521	●	D32-L170 M16-IC 	32	28,7	170	40	M16	0,784
VT522	●	D32-L220 M16	32	28,7	220	40	M16	0,860
VT523	●	D32-L220 M16-IC 	32	28,7	220	40	M16	0,854
VT524	●	D32-L300 M16	32	28,7	300	40	M16	1,380
VT525	●	D32-L300 M16-IC 	32	28,7	300	40	M16	1,375

● Stokta/ In Stock/ Lager ○ Sınırlı Stok/ Limited Stock/ Begrenzte Lagerhaltung

Kalite için Teknik Çözüm | Technical Solution For Quality

BROTECH

TEKNİK
Cutting Tools

www.teknikcuttingtools.com

113

Kalite için TEKNİK çözüm
Technical solution for quality



Diş Katerleri
Threading Holders
Klemmhalter (Außengewinde)



**Technical Solution
for Quality**



Diş Çap Diş Kateri/R

External Threading Toolholders/R

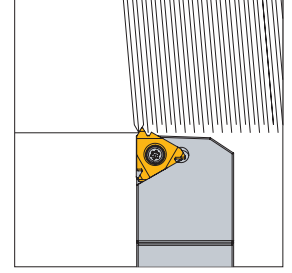
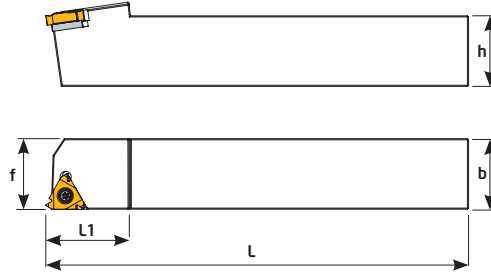

Sipariş Kodu Order Code Best.-Nr.	Stok/Stock/Lager	Ürün Kodu Product Code Produkt-Code	Ölçüler (mm) Dimensions(mm) Abmessungen (mm)							Uç Insert WSP	Sıkma Cıvatası Clamp Screw Torx-Schraube	Altlık Shim U-Platte	Altlık Cıvatası Shim Screw U-Platte Schraube	Anahtar Torx Key Torx-Schlüssel
			h	b	f	L	L1	kg						
D261	●	AL 1212 J16- ER16	12	12	16	110	20	0,140	16 ER	TC068 M3,5x11	TA040	TC048 M5	T15	
D259	●	AL 1616 H16- ER16	16	16	16	100	22	0,250						
D258	●	AL 2020 K16- ER16	20	20	20	125	25	0,410						
D260	●	AL 2525 M16- ER16	25	25	25	150	30	0,750						
D262	●	AL 3232 P16- ER16	32	32	32	170	30	1,430						
D266	●	AL 2525 M22- ER22	25	25	25	150	30	0,740	22 ER	TC078 M4x11	---	---		

Diş Çap Diş Kateri/L

External Threading Toolholders/L

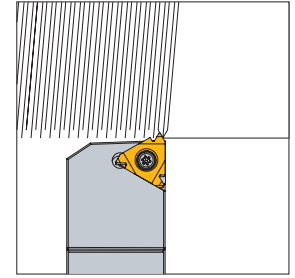
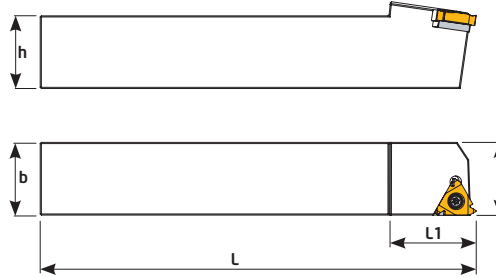

Sipariş Kodu Order Code Best.-Nr.	Stok/Stock/Lager	Ürün Kodu Product Code Produkt-Code	Ölçüler (mm) Dimensions(mm) Abmessungen (mm)							Uç Insert WSP	Sıkma Cıvatası Clamp Screw Torx-Schraube	Altlık Shim U-Platte	Altlık Cıvatası Shim Screw U-Platte Schraube	Anahtar Torx Key Torx-Schlüssel
			h	b	f	L	L1	kg						
D268	●	AL 2020 K16 - L IR16	20	20	20	125	25	0,410	16 IR	TC068 M3,5x11	TA040	TC048 M5	T15	
D269	●	AL 2525 M16 - L IR16	25	25	25	150	30	0,754						
D266-1	●	AL 2525 M22 - L IR22	25	25	25	150	30	0,748						22 IR



İç Çap Diş Kateri/R

Internal Threading Toolholders/R

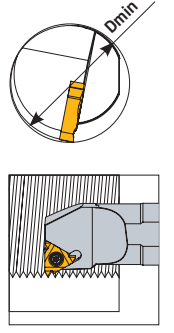
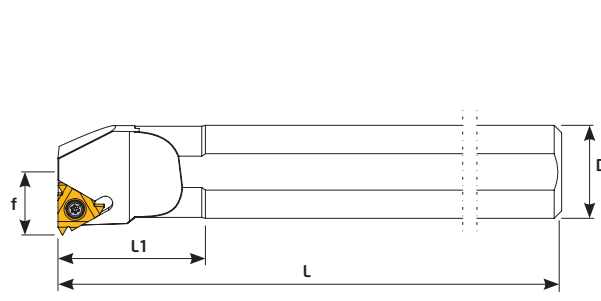

Sipariş Kodu Order Code Best.-Nr.	Stok/Stock/Lager	Ürün Kodu Product Code Produkt-Code	Ölçüler (mm) Dimensions(mm) Abmessungen (mm)					Delik Çapı	Kullanılan Uç Insert WSP	Sıkma Civatası Clamp Screw Torx-Schraube	Anahtar Torx Key Torx-Schlüssel
			D	L	L1	f	Dmin				
K348	●	S10J STIR- IR11	10	110	20	6	12	0,079	11 IR	TC060 M2,5x5,5	T8
K350	●	S12K STIR- IR11	12	125	25	7,2	14	0,117			
K352	●	S16Q STIR- IR16	16	180	40	11	20	0,286	16 IR	TC067 M3,5x8,5	T10
K354	●	S20Q STIR- IR16	20	180	40	13	25	0,436			
K356	●	S25R STIR- IR16	25	200	40	16	29	0,762			
K358	●	S32T STIR- IR16	32	300	60	19,5	36	1,829			
K358-1	●	S20Q STIR- IR22	20	180	40	14	24	0,431	22 IR	TC078 M4x11	T15
K359	●	S25R STIR- IR22	25	200	40	17	32	0,757			
K360	●	S32T STIR- IR22	32	300	60	19,5	36	1,818			
K360-1	●	S40T STIR- IR22	40	300	60	24,5	45	2,831			

İç Çap Diş Kateri/L

Internal Threading Toolholders/L

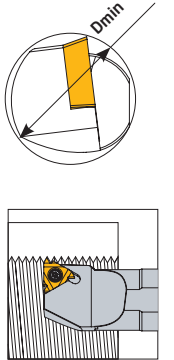
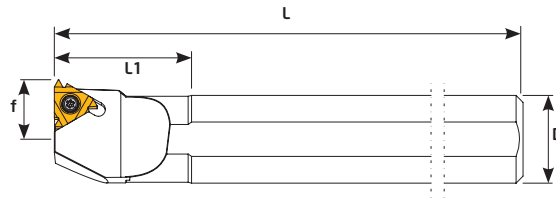

Sipariş Kodu Order Code Best.-Nr.	Stok/Stock/Lager	Ürün Kodu Product Code Produkt-Code	Ölçüler (mm) Dimensions(mm) Abmessungen (mm)					Delik Çapı	Kullanılan Uç Insert WSP	Sıkma Civatası Clamp Screw Torx-Schraube	Anahtar Torx Key Torx-Schlüssel
			D	L	L1	f	Dmin				
K360-2	●	S10J STIL-ER11	10	110	20	6	12	0,079	11 ER	TC060 M2,5x5,5	T8
K361	●	S16Q STIL-ER16	16	180	40	11	20	0,286	16 ER	TC067 M3,5x8,5	T10
K362	●	S20Q STIL-ER16	20	180	40	13	25	0,436			
K363	●	S25R STIL-ER16	25	200	40	16	29	0,762			

● Stokta/In Stock/Lager ○ Sınırlı Stok/Limited Stock/Begrenzte Lagerhaltung

Kalite için Teknik Çözüm | Technical Solution For Quality

BROTECH

TEKNIK
Cutting Tools

www.teknikcuttingtools.com

117

Dış Çap Diş Kateri/R
External Threading Toolholders/R

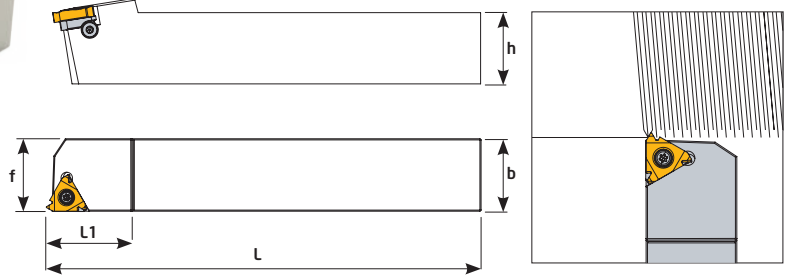

Sipariş Kodu Order Code Best.-Nr.	Stok/Stock/Lager	Ürün Kodu Product Code Produkt-Code	Ölçüler (mm) Dimensions(mm) Abmessungen (mm)						Uç Insert WSP	Sıkma Civatası Clamp Screw Torx-Schraube	Altlık Shim U-Platte	Pul Washer U-Scheibe	Altlık Civatası Shim Screw U-Platte Schraube	Anahtar Torx Key Torx-Schlüssel	
			h	b	f	L	L1	kg							
D494	●	SER 0808 H11 - ER11	8	8	11	100	20	0,061	11 ER	TC060 M2,5x5,5	-	-	-	-	T8
D495	●	SER 1010 H11 - ER11	10	10	11	100	20	0,091							
D496	●	SER 1010 M11 - ER11	10	10	11	150	20	0,136							
D497	●	SER 1212 K11 - ER11	12	12	12	125	20	0,160							
D498	●	SER 1212 M11 - ER11	12	12	12	150	20	0,193							
D500	●	SER 1212 J16 - ER16	12	12	16	110	22	0,110	16 ER	TC068 M3,5x11	TA061	BSP010	TC062 M3	T15	
D501	●	SER 1616 H16 - ER16	16	16	16	100	25	0,220							
D502	●	SER 2020 K16 - ER16	20	20	20	125	30	0,410							
D503	●	SER 2525 M16 - ER16	25	25	25	150	30	0,750							
D504	●	SER 3232 P16 - ER16	32	32	32	170	30	1,410							
D505	●	SER 2525 M22 - ER22	25	25	25	150	30	0,740	22 ER	TC077 M4x15	TA062	-	-	-	
D506	●	SER 3232 P22 - ER22	32	32	32	170	30	1,396							
D507	●	SER 4040 R22 - ER22	40	40	40	200	36	2,585							
D491	●	SER 2525 M27 - ER27	25	25	32	150	36	0,791	27 ER	TC086 M5x18	TA064	-	TC053 M4	T20	
D492	●	SER 3232 P27 - ER27	32	32	32	170	40	1,405							
D493	●	SER 4040 R27 - ER27	40	40	40	200	40	2,589							



Dış Çap Diş Kateri/L

External Threading Toolholders/L

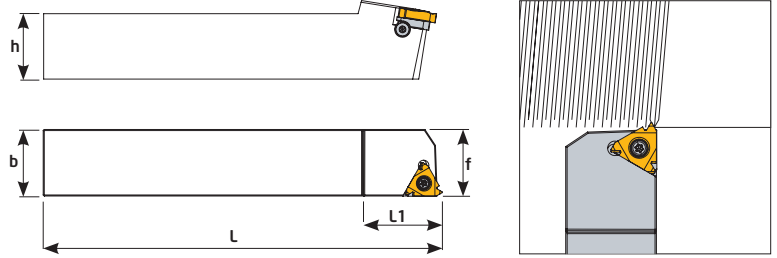
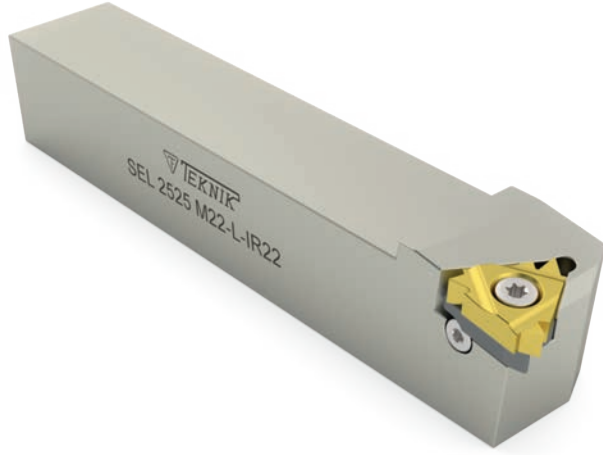

Sipariş Kodu Order Code Best.-Nr.	Stok/Stock/Lager	Ürün Kodu Product Code Produkt-Code	Ölçüler (mm) Dimensions(mm) Abmessungen (mm)						Uç Insert WSP	Sıkma Civatası Clamp Screw Torx-Schraube	Altılık Shim U-Platte	Pul Washer U-Scheibe	Altılık Civatası Shim Screw U-Platte Schraube	Anahtar Torx Key Torx-Schlüssel
			h	b	f	L	L1							
D508	●	SEL 1212 J16 -L- IR16	12	12	16	110	22	0,119	16 IR	TC068 M3,5x11	TA060	BSP010	TC062 M3	T15
D509	●	SEL 1616H16 -L- IR16	16	16	16	100	25	0,223						
D510	●	SEL 2020 K16 -L- IR16	20	20	20	125	30	0,414						
D511	●	SEL 2525 M16 -L- IR16	25	25	25	150	30	0,753						
D512	●	SEL 3232 P16 -L- IR16	32	32	32	170	30	1,417						
D513	●	SEL 2525 M22 -L- IR22	25	25	25	150	30	0,749	22 IR	TC077 M4x15	TA063	TC062 M3		
D515	●	SEL 3232 P22 -L- IR22	32	32	32	170	36	1,434						

İç Çap Dış Kateri/R
Internal Threading Toolholders/R

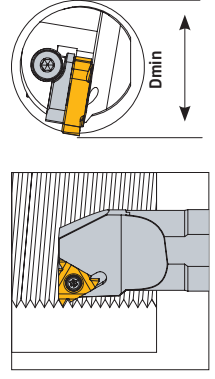
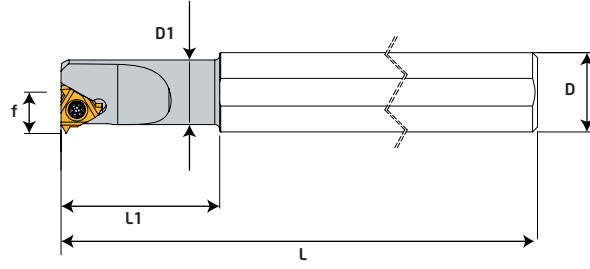

Sipariş Kodu Order Code Best.-Nr.	Stok/Stock/Lager	Ürün Kodu Product Code Produkt-Code	Ölçüler (mm) Dimensions (mm) Abmessungen (mm)					Delik Çapı	Uç Insert WSP	Sıkma Civatası Clamp Screw Torx-Schraube	Altlık Shim U-Platte	Pul Washer U-Scheibe	Altlık Civatası Shim Screw U-Platte Schraube	Anahtar Torx Key Torx-Schlüssel	
			D	D1	L	L1	f								Dmin
K337-1	●	SIR S12H - IR06	12	5,1	100	12	4,3	6	0,089	6 IR	TC058 M2x4,2	-	-	-	T6
K337-2	●	SIR S16K - IR08	16	6,6	125	18	5,3	7,8	0,195	8 IR	TC058-1 M2x4,6	-	-	-	
K337-3	●	SIR S10H - IR11	10	-	100	20	7,4	12	0,063	11 IR	TC060 M2,5x5,5	-	-	-	T8
K337-4	●	SIR S16K - IR11	16	10	125	25	7,4	12	0,167						
K337-5	●	SIR S16L - IR11	16	13	140	32	8,9	15	0,207	16 IR	TC067 M3,5x8,5	-	-	-	T15
K337-6	●	SIR S16M - IR16	16	13	150	32	10,2	16	0,221						
K337-7	●	SIR S20P - IR16	20	16	170	40	11,7	19	0,381	16 IR	TC068 M3,5x11	TA060	BSP010	TC062 M3	T15
K338	●	SIR S20Q - IR16	20	-	180	40	13,4	24	0,440						
K339	●	SIR S25R - IR16	25	-	200	45	16,1	29	0,760	16 IR	TC068 M3,5x11	TA060	BSP010	TC062 M3	T15
K340	●	SIR S32T - IR16	32	-	300	60	21,5	39	1,830						
K341	●	SIR S40T - IR16	40	-	300	60	24,5	45	2,830	22 IR	TC077 M4x15	TA063	BSP010	TC062 M3	T15
K342	●	SIR S50U - IR16	50	-	350	75	28,7	54	5,337						
K342-1	●	SIR S20P - IR22	20	-	170	40	15,6	24	0,433	22 IR	TC078 M4x11	-	-	-	T20
K343	●	SIR S25R - IR22	25	-	200	45	16,1	30	0,760	22 IR	TC077 M4x15	TA063	BSP010	TC062 M3	
K344	●	SIR S32T - IR22	32	-	300	40	22	39	1,820						
K345	●	SIR S40T - IR22	40	-	300	60	25,6	46	2,840	27 IR	TC086 M5x18	TA065	-	TC053 M4	T20
K346	●	SIR S50U - IR22	50	-	350	75	30,6	56	5,335						
K347	●	SIR S32S - IR27	32	-	250	60	22,6	40	1,523	27 IR	TC086 M5x18	TA065	-	TC053 M4	T20
K347-1	●	SIR S40T - IR27	40	-	300	60	26,6	48	2,890						
K347-2	●	SIR S50U - IR27	50	-	350	75	31,6	58	5,177	27 IR	TC086 M5x18	TA065	-	TC053 M4	T20
K347-4	●	SIR S60V - IR27	60	-	400	75	36,6	68	8,700						

● Stokta/In Stock/Lager ○ Sınırlı Stok/Limited Stock/Begrenzte Lagerhaltung



İçten Soğutmalı İç Çap Diş Kater/R Internal Threading Toolholders With Coolant/R

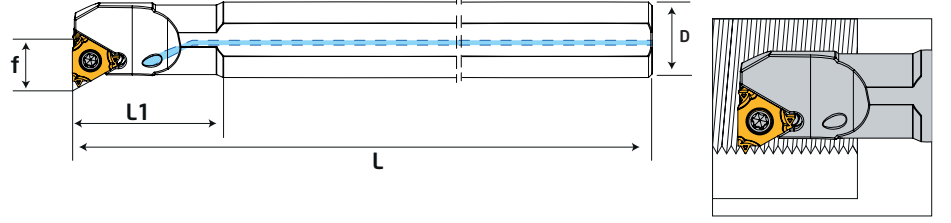

Sipariş Kodu Order Code Best.-Nr.	Stok/Stock/Lager	Ürün Kodu Product Code Produkt-Code	Ölçüler (mm) Dimensions(mm) Abmessungen (mm)					Delik Çapı kg	Uç Insert WSP	Sıkma Civatası Clamp Screw Torx-Schraube	Altlık Shim U-Platte	Pul Washer U-Scheibe	Altlık Civatası Shim Screw U-Platte Schraube	Anahtar Torx Key Torx-Schlüssel	
			D	L	L1	f	Dmin								
K327-1	●	SIR A16K - IR11	16	125	25	7,4	12	0,165	11 IR	TC060 M2,5x5,5					T8
K327-2	●	SIR A16M - IR16	16	150	32	10,2	16	0,220	16 IR	TC067 M3,5x8,5	-	-	-	T15	
K327-3	●	SIR A20P - IR16	20	170	40	11,7	19	0,380							
K327-4	●	SIR A20P - IR16	20	170	40	13,7	24	0,412	16 IR	TC068 M3,5x11	TA060	BSP10	TC062 M3	T15	
K327-5	●	SIR A25R - IR16	25	200	45	16,2	29	0,710							
K327-6	●	SIR A25R - IR22	25	200	45	18,1	29	0,730	22 IR	TC077 M4x15	TA063				

İç Çap Diş Kateri/L Internal Threading Toolholders/L

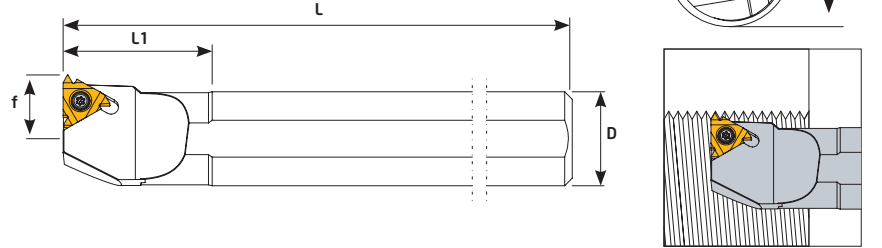
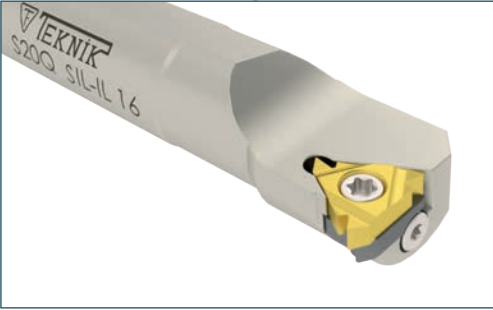

Sipariş Kodu Order Code Best.-Nr.	Stok/Stock/Lager	Ürün Kodu Product Code Produkt-Code	Ölçüler (mm) Dimensions(mm) Abmessungen (mm)					Delik Çapı kg	Uç Insert WSP	Sıkma Civatası Clamp Screw Torx-Schraube	Altlık Shim U-Platte	Pul Washer U-Scheibe	Altlık Civatası Shim Screw U-Platte Schraube	Anahtar Torx Key Torx-Schlüssel
			D	L	L1	f	Dmin							
K330	●	SIL S20Q - ER16	20	180	40	13,4	24	0,440	16ER	TC068 M3,5x11	TA061	BSP010	TC062 M3	T15
K331	●	SIL S25R - ER16	25	200	45	16,1	29	0,760						
K332	●	SIL S32T - ER16	32	300	60	21,5	39	1,830						
K333	●	SIL S40T - ER16	40	300	60	24,5	45	2,830						
K334	●	SIL S25R - ER22	25	200	45	16,1	30	0,760	22ER	TC077 M4x15	TA062			
K335	●	SIL S32T - ER22	32	300	40	22	39	1,820						
K336	●	SIL S40T - ER22	40	300	60	24,5	50	2,840						

● Stokta/In Stock/Lager ○ Sınırlı Stok/Limited Stock/Begrenzte Lagerhaltung

Kalite için Teknik Çözüm | Technical Solution For Quality

BROTECH

TEKNİK
Cutting Tools

www.teknikcuttingtools.com

121

**NEW
PRODUCT**

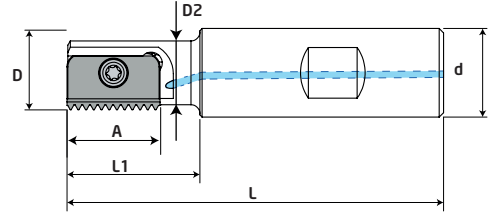

Sipariş Kodu Order Code Best.-Nr.	Stok/Stock/Lager	Ürün Kodu Product Code Produkt-Code	Ölçüler (mm) Dimensions(mm) Abmessungen (mm)								Kullanılan Uç Insert WSP	Sıkma Cıvatası Clamp Screw Torx-Schraube	Anahtar Torx Key Torx-Schlüssel
			A	D	d	D2	L	L1	kg				
DC201	●	D9,5 d20 L085 A12 S12	12	9,5	20	7,5	85	14	0,195	S12	TC092 M2,5x5,5	T8	
DC202	●	D9,9 d20 L085 A12 S12	12	9,9	20	7,6	85	16	0,191				
DC203	●	D12 d20 L075 A14 S14	14	12	20	8,9	75	20	0,156				
DC204	●	D14,5 d20 L085 A14 S14	14	14,5	20	11,2	85	25	0,179	S14	TC096 M2,5x7	T8	
DC205	●	D17 d20 L085 A14 S14	14	17	20	13,4	85	30	0,180				
DC206	●	D18 d20 L085 A21 S21	21	18	20	14,4	85	30	0,176	S21	TC074 M4x10	T15	
DC207	●	D21 d20 L094 A21 S21	21	21	20	16,5	94	40	0,204				
DC208	●	D29 d25 L110 A30 S30	30	29	25	22,4	110	50	0,390	S30	TC256 M5x12	T20	
DC209	●	D48 d40 L153 A40 S40	40	48	40	35	153	78	1,325				

**NEW
PRODUCT**

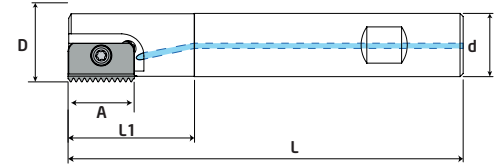

Sipariş Kodu Order Code Best.-Nr.	Stok/Stock/Lager	Ürün Kodu Product Code Produkt-Code	Ölçüler (mm) Dimensions(mm) Abmessungen (mm)						Kullanılan Uç Insert WSP	Sıkma Cıvatası Clamp Screw Torx-Schraube	Anahtar Torx Key Torx-Schlüssel
			A	D	d	L	L1	kg			
DC210	●	D25 d20 L125 A21 S21	21	25	20	125	40	0,320	S21	TC074 M4x10	T15
DC211	●	D31 d25 L150 A30 S30	30	31	25	150	60	0,597			
DC212	●	D38 d32 L150 A30 S30	30	38	32	150	60	1,005	S30	TC256 M5x12	T20
DC213	●	D48 d40 L210 A40 S40	40	48	40	210	78	2,068			

**NEW
PRODUCT**

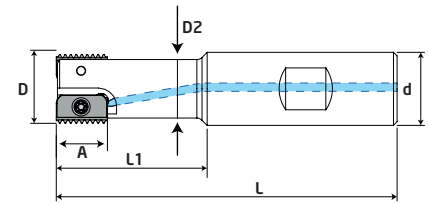

Sipariş Kodu Order Code Best.-Nr.	Stok/Stock/Lager	Ürün Kodu Product Code Produkt-Code	Ölçüler (mm) Dimensions(mm) Abmessungen (mm)							Kullanılan Uç Insert WSP	Sıkma Cıvatası Clamp Screw Torx-Schraube	Anahtar Torx Key Torx-Schlüssel
			A	D	d	D2	L	L1	kg			
DC214	●	D20 d20 L093 A14 S14	14	20	20	16	93	41	0,202	S14	TC093 M2,5x7	T8
DC215	●	D30 d25 L108 A21 S21	21	30	25	24	108	52	0,401			
DC216	●	D40 d32 L130 A30 S30	30	40	32	30	130	70	0,781	S30	TC256 M5x12	T20
DC217	●	D50 d40 L153 A40 S40	40	50	40	38	153	78	1,455			



Diş Çap Kater Soğutmalı
Turning Holder With Coolant
Drehhalter Gekühlt

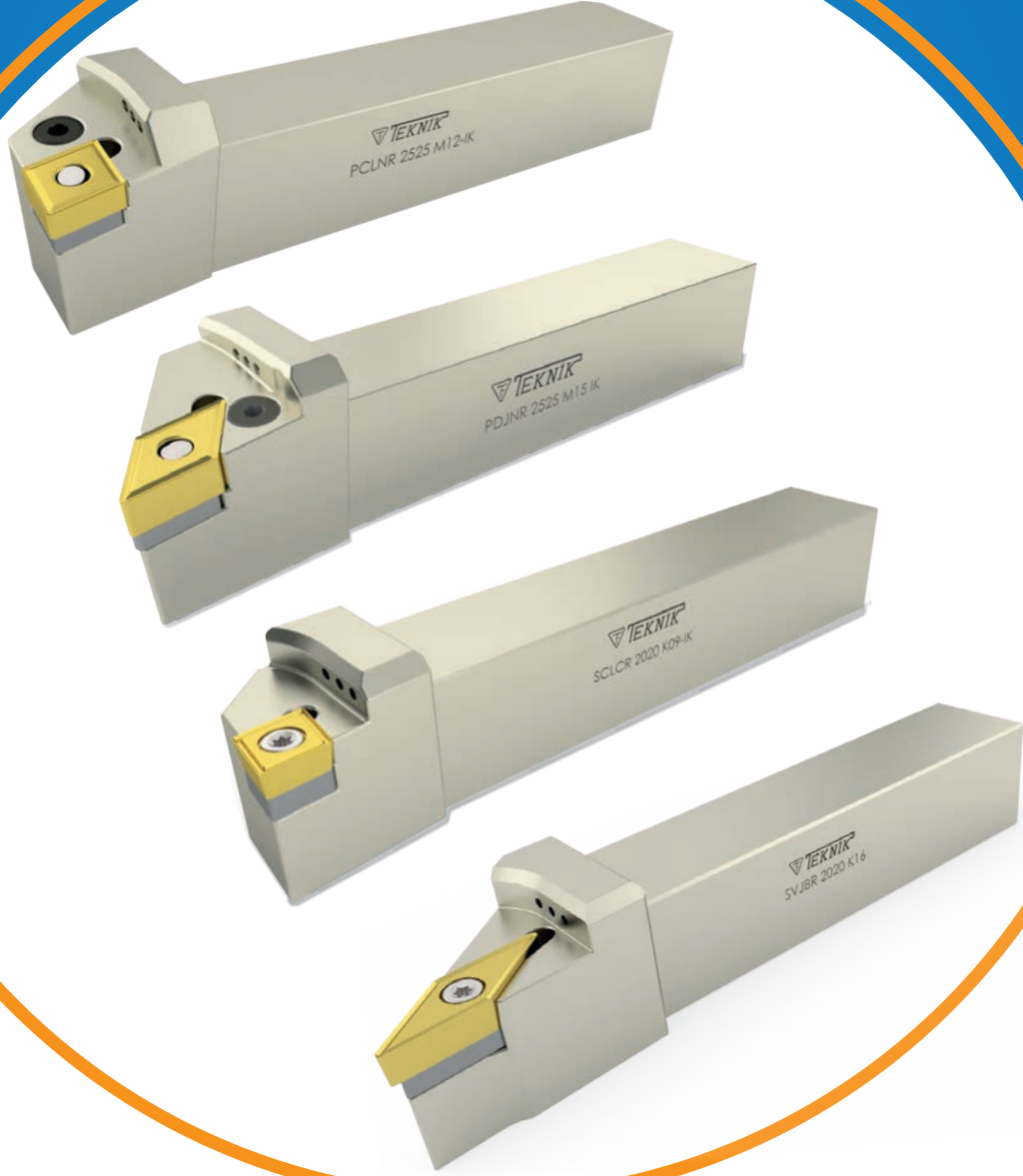

**Technical Solution
for Quality**



İçten Soğutmalı Diş Çap Kater
External Turning Holders With Coolant

93° PDJNR IC

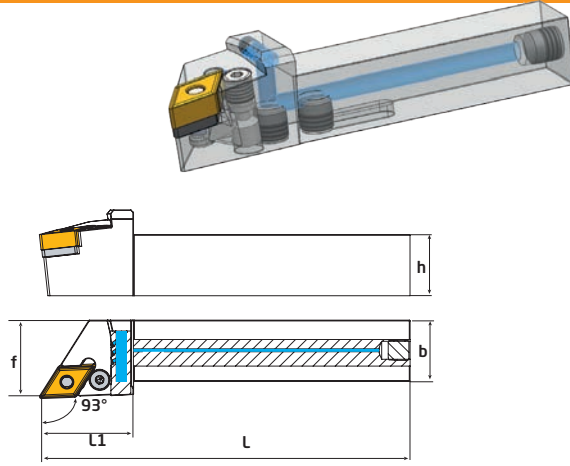

Sipariş Kodu Order Code Best.-Nr.	Stok/Stock/Lager	Ürün Kodu Product Code Produkt-Code	Ölçüler (mm) Dimensions(mm) Abmessungen (mm)							Uç Insert WSP	Civata Clamp Screw Klemm-Schraube	Altlık Shim U-Platte	Levye Sacı Lock Pin Rohrstift	Levye Lever Kniehebel	Anahtar Allen Key Inbuss-Schlüssel
			L	L1	h	f	b	kg							
AP110	●	PDJNR 2020 K15-ICG1/8	125	40	20	25	20	0,409	DNMG 1506	TH822	TA014-1	TS-4	TL4B	3 Allen	
AP112	●	PDJNR 2525 M15-ICG1/8	150	40	25	32	25	0,759	DNMG 1506	TH825	TA014-1				

İçten Soğutmalı Diş Çap Kater
External Turning Holders With Coolant

93° PDJNL IC

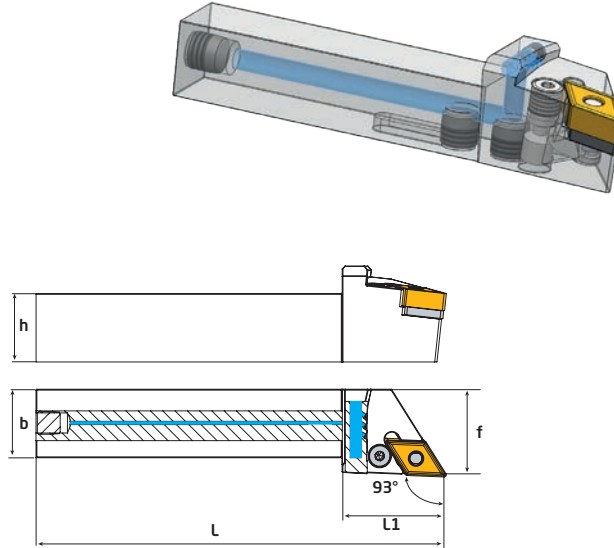

Sipariş Kodu Order Code Best.-Nr.	Stok/Stock/Lager	Ürün Kodu Product Code Produkt-Code	Ölçüler (mm) Dimensions(mm) Abmessungen (mm)							Uç Insert WSP	Civata Clamp Screw Klemm-Schraube	Altlık Shim U-Platte	Levye Sacı Lock Pin Rohrstift	Levye Lever Kniehebel	Anahtar Allen Key Inbuss-Schlüssel
			L	L1	h	f	b	kg							
AP122	●	PDJNL 2020 K15-ICG1/8	125	40	20	25	20	0,409	DNMG 1506	TH822	TA014-1	TS-4	TL4B	3 Allen	
AP124	●	PDJNL 2525 M15-ICG1/8	150	40	25	32	25	0,759	DNMG 1506	TH825	TA014-1				



İçten Soğutmalı Diş Çap Kater
External Turning Holders With Coolant

95° PCLNR IC

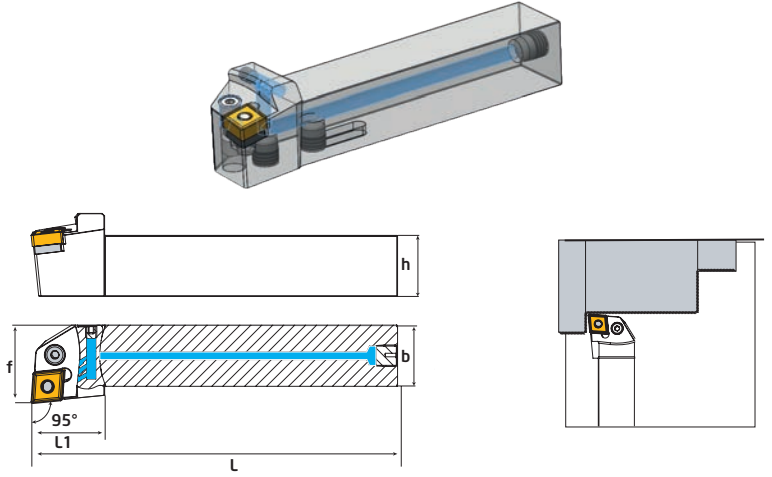
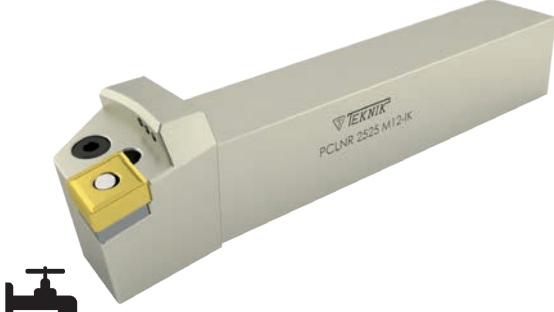

Sipariş Kodu Order Code Best.-Nr.	Stok/Stock/Lager	Ürün Kodu Product Code Produkt-Code	Ölçüler (mm) Dimensions(mm) Abmessungen (mm)						Uç Insert WSP	Civata Clamp Screw Klemm-Schraube	Altlık Shim U-Platte	Levye Sacı Lock Pin Rohrstift	Levye Lever Kniehebel	Anahtar Allen Key Inbuss-Schlüssel
			L	L1	h	f	b	ISO						
AP129	●	PCLNR 1616 H12-ICG1/8	100	28	16	20	16	0,236	CNMG 1204	TH818	TA016-1	TS4	TL4	3 Allen
AP130	●	PCLNR 2020 K12-ICG1/8	125	28	20	25	20	0,428	CNMG 1204	TH821	TA016-1	TS4	TL4	
AP132	●	PCLNR 2525 M12-ICG1/8	150	30	25	32	25	0,781						

İçten Soğutmalı Diş Çap Kater
External Turning Holders With Coolant

95° PCLNL IC

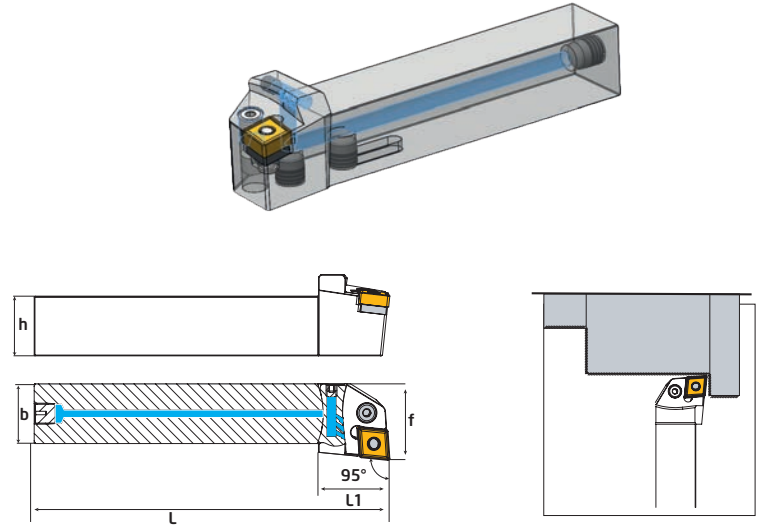

Sipariş Kodu Order Code Best.-Nr.	Stok/Stock/Lager	Ürün Kodu Product Code Produkt-Code	Ölçüler (mm) Dimensions(mm) Abmessungen (mm)						Uç Insert WSP	Civata Clamp Screw Klemm-Schraube	Altlık Shim U-Platte	Levye Sacı Lock Pin Rohrstift	Levye Lever Kniehebel	Anahtar Allen Key Inbuss-Schlüssel
			L	L1	h	f	b	ISO						
AP139	●	PCLNL 1616 H12-ICG1/8	100	28	16	20	16	0,236	CNMG 1204	TH 818	TA016-1	TS4	TL4	3 Allen
AP140	●	PCLNL 2020 K12-ICG1/8	125	28	20	25	20	0,428	CNMG 1204	TH821	TA016-1	TS4	TL4	
AP142	●	PCLNL 2525 M12-ICG1/8	150	30	25	32	25	0,781						

İçten Soğutmalı Diş Çap Kater
External Turning Holders With Coolant

95° PWLNR 08 IC

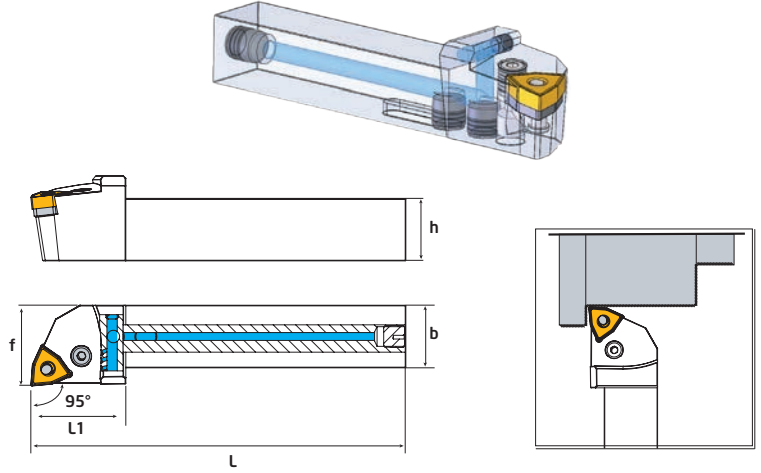

Sipariş Kodu Order Code Best.-Nr.	Stok/Stock/Lager	Ürün Kodu Product Code Produkt-Code	Ölçüler (mm) Dimensions(mm) Abmessungen (mm)							Uç Insert WSP	Civata Clamp Screw Klemm-Schraube	Altlık Shim U-Platte	Levye Sacı Lock Pin Rohrstift	Levye Lever Kniehebel	Anahtar Allen Key Inbuss-Schlüssel
			L	L1	h	f	b	kg							
AP150	●	PWLNR 2020 K08-ICG1/8	125	30	20	25	20	0,425	WNMG 0804	TH821	TA020-1	TS4	TL4	3 Allen	
AP151	●	PWLNR 2525 M08-ICG1/8	150	38	25	32	25	0,782							

İçten Soğutmalı Diş Çap Kater
External Turning Holders With Coolant

95° PWLNL 08 IC

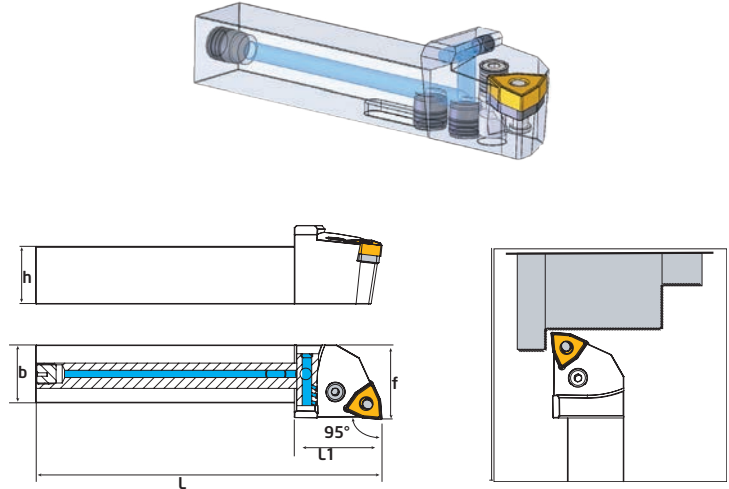

Sipariş Kodu Order Code Best.-Nr.	Stok/Stock/Lager	Ürün Kodu Product Code Produkt-Code	Ölçüler (mm) Dimensions(mm) Abmessungen (mm)							Uç Insert WSP	Civata Clamp Screw Klemm-Schraube	Altlık Shim U-Platte	Levye Sacı Lock Pin Rohrstift	Levye Lever Kniehebel	Anahtar Allen Key Inbuss-Schlüssel
			L	L1	h	f	b	kg							
AP155	●	PWLNL 2020 K08-ICG1/8	125	30	20	25	20	0,425	WNMG 0804	TH821	TA020-1	TS4	TL4	3 Allen	
AP156	●	PWLNL 2525 M08-ICG1/8	150	38	25	32	25	0,782							



İçten Soğutmalı Dış Çap Kater
External Turning Holders With Coolant
95° PWLNR 06 IC

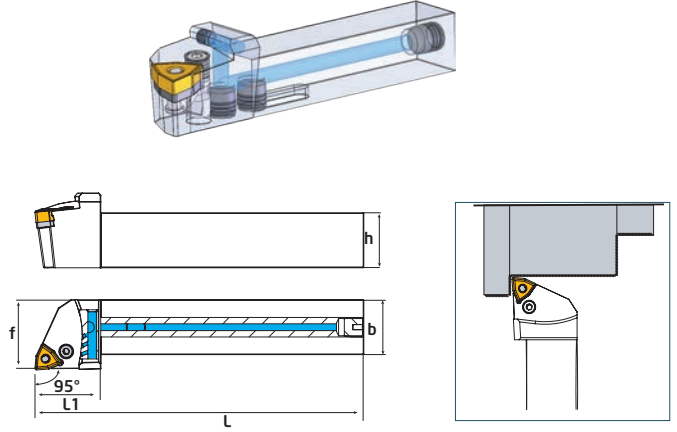

Sipariş Kodu Order Code Best.-Nr.	Stok/Stock/Lager	Ürün Kodu Product Code Produkt-Code	Ölçüler (mm) Dimensions(mm) Abmessungen (mm)						Uç Insert WSP	Civata Clamp Screw Klemm-Schraube	Altık Shim U-Platte	Levye Sacı Lock Pin Rohrstift	Levye Lever Kniehebel	Anahtar Allen Key Inbuss-Schlüssel
			L	L1	h	f	b	KG						
AP158	●	PWLNK 1616 H06-ICG1/8	100	30	16	20	16	0,218	WNMG 0604	TH617	TA021	TS3	TL3	2,5 Allen
AP160	●	PWLNK 2020 K06-ICG1/8	125	30	20	25	20	0,415						
AP161	●	PWLNK 2525 M06-ICG1/8	150	30	25	32	25	0,756						

İçten Soğutmalı Dış Çap Kater
External Turning Holders With Coolant
95° PWLNL 06 IC

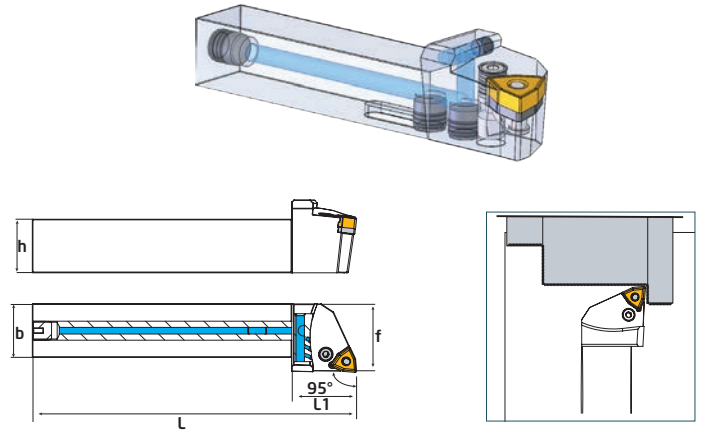

Sipariş Kodu Order Code Best.-Nr.	Stok/Stock/Lager	Ürün Kodu Product Code Produkt-Code	Ölçüler (mm) Dimensions(mm) Abmessungen (mm)						Uç Insert WSP	Civata Clamp Screw Klemm-Schraube	Altık Shim U-Platte	Altık Pimi Lock Pin Rohrstift	Levye Lever Kniehebel	Anahtar Allen Key Inbuss-Schlüssel
			L	L1	h	f	b	KG						
AP164	●	PWLNK 1616 H06-ICG1/8	100	30	16	20	16	0,218	WNMG 0604	TH617	TA021	TS3	TL3	2,5 Allen
AP165	●	PWLNK 2020 K06-ICG1/8	125	30	20	25	20	0,415						
AP166	●	PWLNK 2525 M06-ICG1/8	150	30	25	32	25	0,756						

İçten Soğutmalı Dış Çap Kater
External Turning Holders With Coolant

95° SCLCR IC

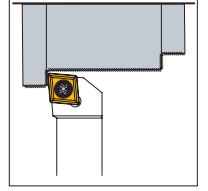
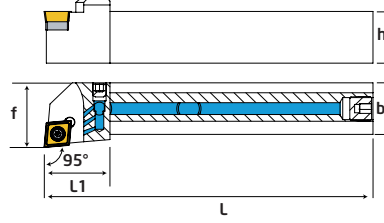
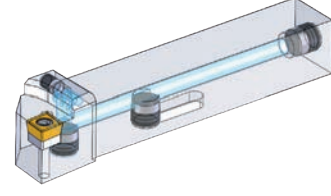

Sipariş Kodu Order Code Best.-Nr.	Stok/Stock/Lager	Ürün Kodu Product Code Produkt-Code	Ölçüler (mm) Dimensions(mm) Abmessungen (mm)						Uç Insert WSP	Civata Clamp Screw Torx-Schraube	Aitlik Shim U-Platte	Aitlik Civatası Shim Screw U-Platte Schraube	Anahtar Torx Key Torx-Schlüssel
			L	L1	h	f	b	⊗					
AP500	●	SCLCR 1616 H09-IC	100	25	16	20	16	0,205	CCMT 09T3	TC068 M3,5x11	TA015	TC048 M5	T15
AP501	●	SCLCR 2020 K09-IC	125	25	20	25	20	0,418					
AP503	●	SCLCR 2525 M12-IC	150	30	25	32	25	0,771	CCMT 1204	TC075 M4x11	TA015-1	TC049-1 M6	

İçten Soğutmalı Dış Çap Kater
External Turning Holders With Coolant

95° SCLCL IC

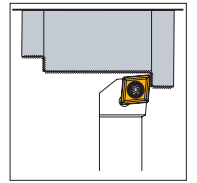
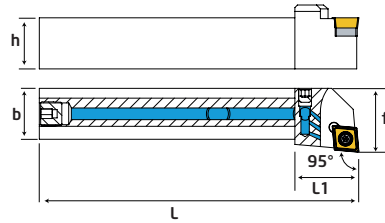
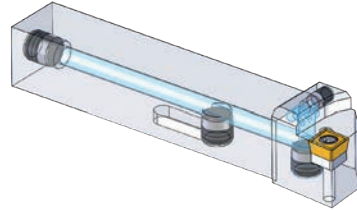
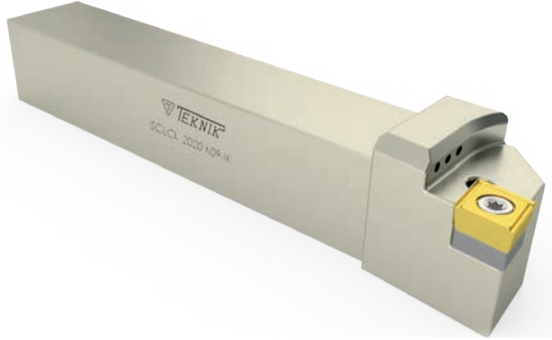

Sipariş Kodu Order Code Best.-Nr.	Stok/Stock/Lager	Ürün Kodu Product Code Produkt-Code	Ölçüler (mm) Dimensions(mm) Abmessungen (mm)						Uç Insert WSP	Sıkma Civatası Clamp Screw Torx-Schraube	Aitlik Shim U-Platte	Aitlik Civatası Shim Screw U-Platte Schraube	Anahtar Torx Key Torx-Schlüssel
			L	L1	h	f	b	⊗					
AP505	●	SCLCL 1616 H09-IC	100	25	16	20	16	0,205	CCMT 09T3	TC068 M3,5x11	TA015	TC048 M5	T15
AP506	●	SCLCL 2020 K09-IC	125	25	20	25	20	0,418					
AP508	●	SCLCL 2525 M12-IC	150	30	25	32	25	0,771	CCMT 1204	TC075 M4x11	TA15-1	TC049-1 M6	



İçten Soğutmalı Diş Çap Kater
External Turning Holders With Coolant

93° SDJCR IC

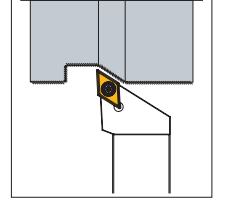
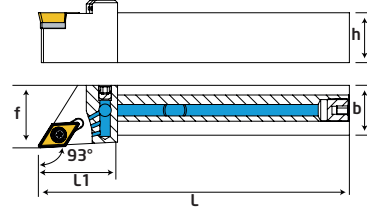
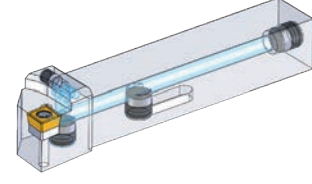
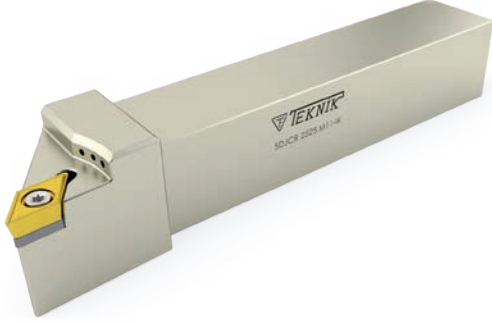

Sipariş Kodu Order Code Best.-Nr.	Stok/Stock/Lager	Ürün Kodu Product Code Produkt-Code	Ölçüler (mm) Dimensions(mm) Abmessungen (mm)							Uç Insert WSP	Sıkma Cıvatası Clamp Screw Torx-Schraube	Altlık Shim U-Platte	Altlık Cıvatası Shim Screw U-Platte Schraube	Anahtar Torx Key Torx-Schlüssel
			L	L1	h	f	b	kg						
AP510	●	SDJCR 1616 H11-IC	100	32	16	20	16	0,204	DCMT 11T3	TC068 M3,5x11	TA030	TC048 M5	T15	
AP511	●	SDJCR 2020 K11-IC	125	32	20	25	20	0,404						
AP512	●	SDJCR 2525 M11-IC	150	35	25	32	25	0,735						

İçten Soğutmalı Diş Çap Kater
External Turning Holders With Coolant

93° SDJCL IC

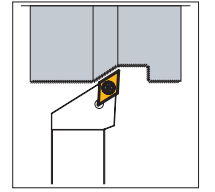
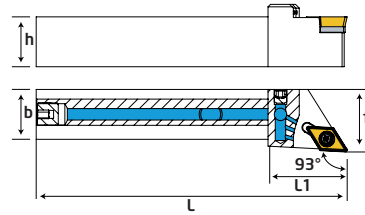
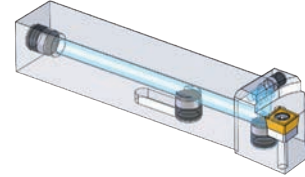

Sipariş Kodu Order Code Best.-Nr.	Stok/Stock/Lager	Ürün Kodu Product Code Produkt-Code	Ölçüler (mm) Dimensions(mm) Abmessungen (mm)							Uç Insert WSP	Sıkma Cıvatası Clamp Screw Torx-Schraube	Altlık Shim U-Platte	Altlık Cıvatası Shim Screw U-Platte Schraube	Anahtar Torx Key Torx-Schlüssel
			L	L1	h	f	b	kg						
AP515	●	SDJCL 1616 H11-IC	100	32	16	20	16	0,204	DCMT 11T3	TC068 M3,5x11	TA030	TC048 M5	T15	
AP516	●	SDJCL 2020 K11-IC	125	32	20	25	20	0,404						
AP517	●	SDJCL 2525 M11-IC	150	35	25	32	25	0,735						

● Stokta/In Stock/Lager ○ Sınırlı Stok/Limited Stock/Begrenzte Lagerhaltung

Kalite için Teknik Çözüm | Technical Solution For Quality



www.teknikcuttingtools.com

İçten Soğutmalı Dış Çap Kater
External Turning Holders With Coolant

93° SDJCR IC

**NEW
PRODUCT**

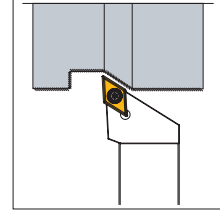
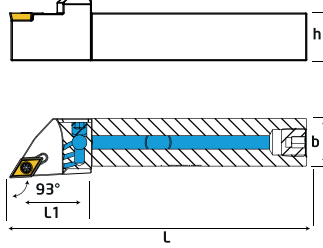
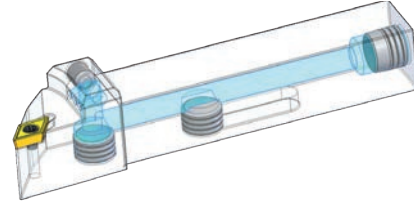

Sipariş Kodu Order Code Best.-Nr.	Stok/Stock/ Lager	Ürün Kodu Product Code Produkt-Code	Ölçüler (mm) Dimensions(mm) Abmessungen (mm)						Uç Insert WSP	Civata Clamp Screw Torx-Schraube	Anahtar Torx Key Torx-Schlüssel
			L	L1	h	f	b	kg			
AP560	●	SDJCR 1212 K07-IC	125	27	12	16	12	0,175	DCMT 0702	TC060 M2,5x5,5	T8
AP561	●	SDJCR 1616 H07-IC	100	27	16	20	16	0,210			
AP562	●	SDJCR 2020 K07-IC	125	27	20	25	20	0,400			

İçten Soğutmalı Dış Çap Kater
External Turning Holders With Coolant

93° SDJCL IC

**NEW
PRODUCT**

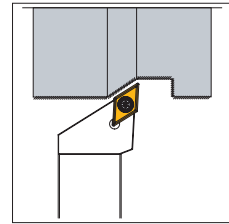
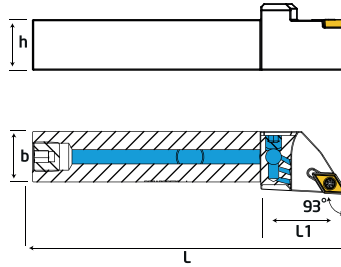
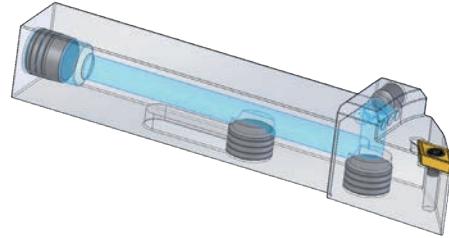

Sipariş Kodu Order Code Best.-Nr.	Stok/Stock/ Lager	Ürün Kodu Product Code Produkt-Code	Ölçüler (mm) Dimensions(mm) Abmessungen (mm)						Uç Insert WSP	Civata Clamp Screw Torx-Schraube	Anahtar Torx Key Torx-Schlüssel
			L	L1	h	f	b	kg			
AP565	●	SDJCL 1212 K07-IC	125	16	16	12	16	0,175	DCMT 0702	TC060 M2,5x5,5	T8
AP566	●	SDJCL 1616 H07-IC	100	27	16	20	16	0,210			
AP567	●	SDJCL 2020 K07-IC	125	27	20	25	20	0,400			



İçten Soğutmalı Diş Çap Kater F Tipi
External Turning Holders With Coolant Type F

93° SDJCR -F IC

**NEW
PRODUCT**

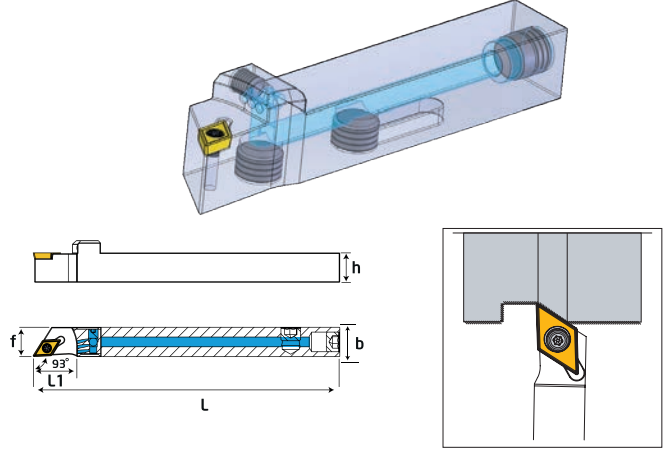

Sipariş Kodu Order Code Best.-Nr.	Stok/Stock/Lager	Ürün Kodu Product Code Produkt-Code	Ölçüler (mm) Dimensions(mm) Abmessungen (mm)						Uç Insert WSP	Sıkma Civatası Clamp Screw Torx-Schraube	Anahtar Torx Key Torx-Schlüssel
			L	L1	h	f	b	Ⓢ			
AP569	●	SDJCR 1212 K07-F-IC	125	27	12	16	12	0,175	DCMT 0702	TC060 M2,5x5,5	T8
AP570	●	SDJCR 1616 H07-F-IC	100	27	16	16	16	0,210			

İçten Soğutmalı Diş Çap Kater F Tipi
External Turning Holders With Coolant Type F

93° SDJCL-F IC

**NEW
PRODUCT**

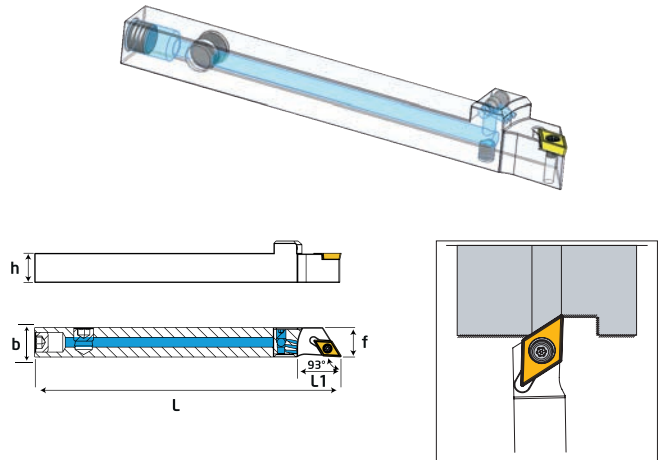

Sipariş Kodu Order Code Best.-Nr.	Stok/Stock/Lager	Ürün Kodu Product Code Produkt-Code	Ölçüler (mm) Dimensions(mm) Abmessungen (mm)						Uç Insert WSP	Sıkma Civatası Clamp Screw Torx-Schraube	Anahtar Torx Key Torx-Schlüssel
			L	L1	h	f	b	Ⓢ			
AP573	●	SDJCL 1212 K07 F-IC	125	27	12	12	12	0,175	DCMT 0702	TC060 M2,5x5,5	T8
AP574	●	SDJCL 1616 H07-F-IC	100	27	16	16	16	0,210			

İçten Soğutmalı Diş Çap Kater
External Turning Holders With Coolant

93° SVJBR IC

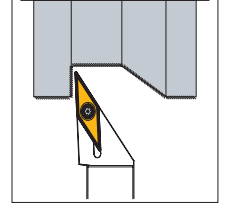
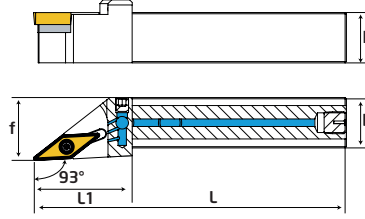
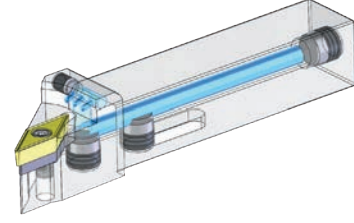
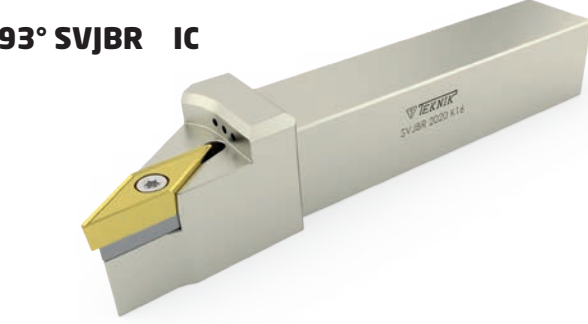

Sipariş Kodu Order Code Best.-Nr.	Stok/Stock/Lager	Ürün Kodu Product Code Produkt-Code	Ölçüler (mm) Dimensions(mm) Abmessungen (mm)							Uç Insert WSP	Sıkma Cıvatası Clamp Screw Torx-Schraube	Altlık Shim U-Platte	Altlık Cıvatası Shim Screw U-Platte Schraube	Anahtar Torx Key Torx-Schlüssel
			L	L1	h	f	b	kg						
AP540	●	SVJBR 1010 J11-İK	110	30	10	12	10	0,097	VBMT 1103	TC061 M2,5x6,5	---	---	T8	
AP541	●	SVJBR 1212 J11-İK	110	32	12	16	12	0,141						
AP545	●	SVJBR 2020 K16-İK	125	40	20	25	20	0,192	VBMT 1604	TC068 M3,5x11	TA034	TC048 M5	T15	
AP546	●	SVJBR 2525 M16-İK	150	40	25	32	25	0,574						

İçten Soğutmalı Diş Çap Kater
External Turning Holders With Coolant

93° SVJBL IC

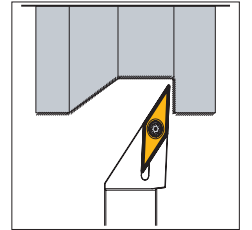
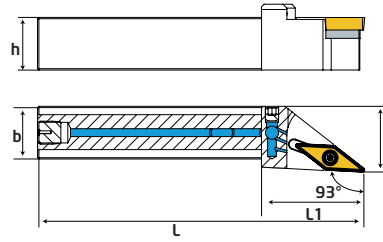
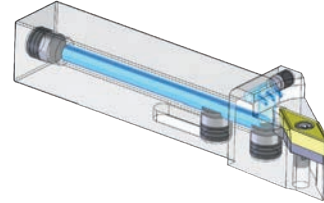
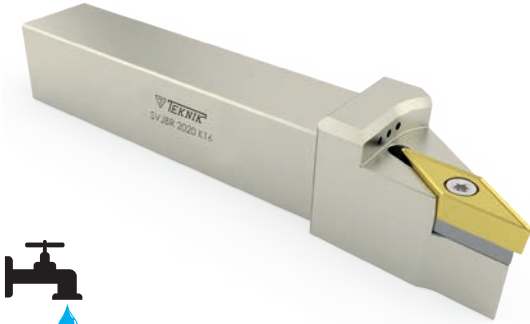

Sipariş Kodu Order Code Best.-Nr.	Stok/Stock/Lager	Ürün Kodu Product Code Produkt-Code	Ölçüler (mm) Dimensions(mm) Abmessungen (mm)							Uç Insert WSP	Sıkma Cıvatası Clamp Screw Torx-Schraube	Altlık Shim U-Platte	Altlık Cıvatası Shim Screw U-Platte Schraube	Anahtar Torx Key Torx-Schlüssel
			L	L1	h	f	b	kg						
AP550	●	SVJBL 1010 J11-İK	110	30	10	12	10	0,097	VBMT 1103	TC061 M2,5x6,5	---	---	T8	
AP551	●	SVJBL 1212 J11-İK	110	32	12	16	12	0,141						
AP555	●	SVJBL 2020 K16-İK	125	40	20	25	20	0,192	VBMT 1604	TC068 M3,5x11	TA034	TC048 M5	T15	
AP556	●	SVJBL 2525 M16-İK	150	40	25	32	25	0,574						



İçten Soğutmalı Diş Çap Kater
External Turning Holders With Coolant

93° SVJCR IC

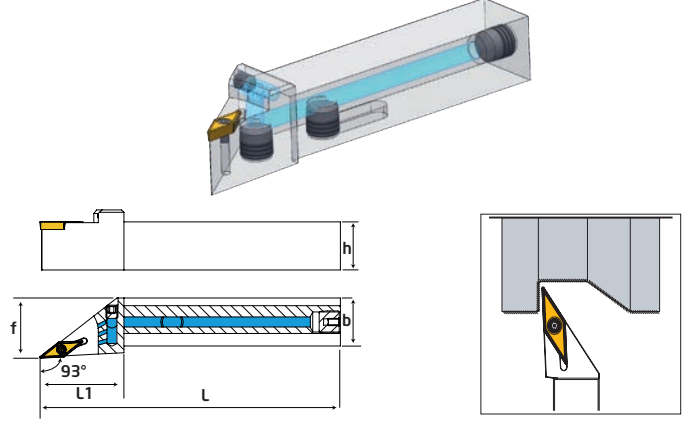

Sipariş Kodu Order Code Best.-Nr.	Stok/Stock/Lager	Ürün Kodu Product Code Produkt-Code	Ölçüler (mm) Dimensions(mm) Abmessungen (mm)						Uç Insert WSP	Sıkma Cıvatası Clamp Screw Torx-Schraube	Altlık im U-Platte	Altlık Cıvatası Shim Screw U-Platte Schraube	Anahtar Torx Key Torx-Schlüssel
			L	L1	h	f	b	kg					
AP520	●	SVJCR 1616 H11-İK	100	25	16	20	16	0,204	VCMT 1103	TC061 M2,5x6,5	---	---	T8
AP521	●	SVJCR 2020 K11-İK	125	33	20	25	20	0,378					
AP525	●	SVJCR 2020 K16-İK	125	33	20	25	20	0,385	VCMT 1604	TC068 M3,5x11	TA034	TC048 M5	T15
AP526	●	SVJCR 2525 M16-İK	150	40	25	32	25	0,683					

İçten Soğutmalı Diş Çap Kater
External Turning Holders With Coolant

93° SVJCL IC

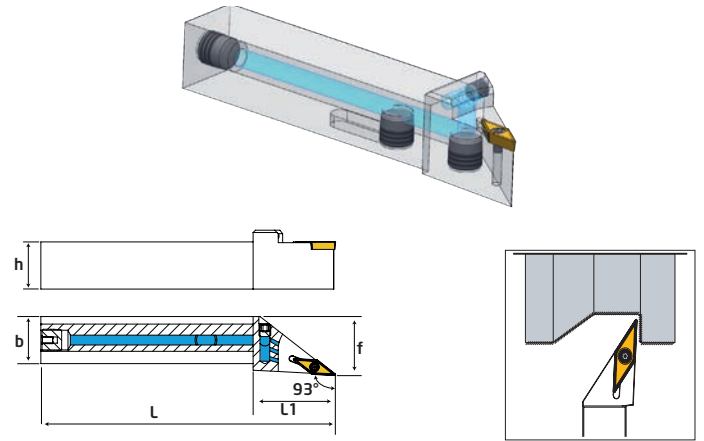

Sipariş Kodu Order Code Best.-Nr.	Stok/Stock/Lager	Ürün Kodu Product Code Produkt-Code	Ölçüler (mm) Dimensions(mm) Abmessungen (mm)						Uç Insert WSP	Sıkma Cıvatası Clamp Screw Torx-Schraube	Altlık im U-Platte	Altlık Cıvatası Shim Screw U-Platte Schraube	Anahtar Torx Key Torx-Schlüssel
			L	L1	h	f	b	kg					
AP530	●	SVJCL 1616 H11-İK	100	25	16	20	16	0,204	VCMT 1103	TC061 M2,5x6,5	---	---	T8
AP531	●	SVJCL 2020 K11-İK	125	33	20	25	20	0,378					
AP535	●	SVJCL 2020 K16-İK	125	33	20	25	20	0,385	VCMT 1604	TC068 M3,5x11	TA034	TC048 M5	T15
AP536	●	SVJCL 2525 M16-İK	150	40	25	32	25	0,683					

Diş Çap Diş Kateri IC
External Threading Toolholders With Coolant

**NEW
PRODUCT**

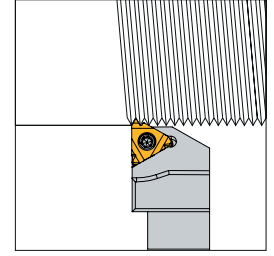
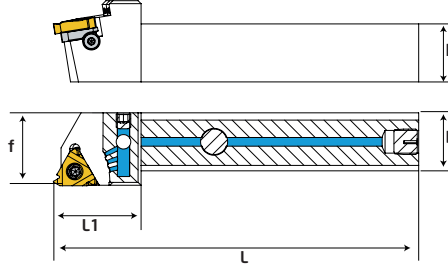
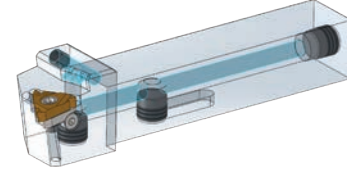

Sipariş Kodu Order Code Best.-Nr	Stok/Stock/Lager	Ürün Kodu Product Code Produkt-Code	Ölçüler (mm) Dimensions(mm) Abmessungen (mm)					Uç Insert WSP	Sıkma Civatası Clamp Screw Torx-Schraube	Altlık Shim U-Platte	Pul Washer U-Scheibe	Altlık Civatası Shim Screw U-Platte Schraube	Anahtar Torx Key Torx-Schlüssel	
			h	b	f	L	L1							KG
AP602	●	SER 2020 K16 - ER16 IK	20	20	20	125	30	0,449	16 ER	TC068 M3,5x11	TA061	TA060	TC062 M3	T15
AP604	●	SER 2525 M16 - ER16 IK	25	25	25	150	30	0,842						



P Sistem Diş Çap Kater
P System External Turning Holder
P System Klemmhalter



**Technical Solution
for Quality**



93° PDJNR

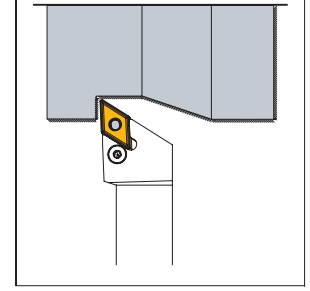
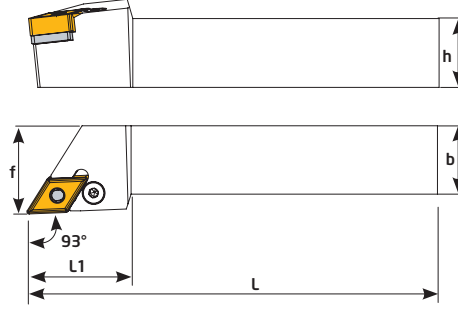
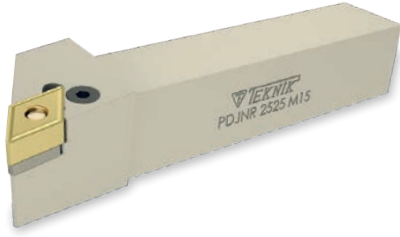

Sipariş Kodu Order Code Best.-Nr.	Stok/Stock/Lager	Ürün Kodu Product Code Produkt-Code	Ölçüler (mm) Dimensions(mm) Abmessungen (mm)						Uç Insert WSP	Sıkma Civatası Clamp Screw Klemm-Schraube	Altlık Shim U-Platte	Levye Sacı Lock Pin Rohrstift	Levye Lever Kniehebel	Anahtar Allen Key Inbuss-Schlüssel
			L	L1	h	f	b	kg						
P107	●	PDJNR 1616 H11	100	25	16	25	16	0,242	DNMG1104	TH613	TA013	TS-3	TL3	2,5 Allen
P108	●	PDJNR 2020 K11	125	30	20	25	20	0,435		TH617				
P109	●	PDJNR 2525 M11	150	30	25	32	25	0,767		TH822				
P110	●	PDJNR 2020 K15	125	35	20	25	20	0,402	DNMG1506	TH825	TA014-1	TS-4	TL4B	3 Allen
P112	●	PDJNR 2525 M15	150	38	25	32	25	0,730		TH825				
P114	●	PDJNR 3232 P15	170	38	32	40	32	1,384		TH825				

93° PDJNL

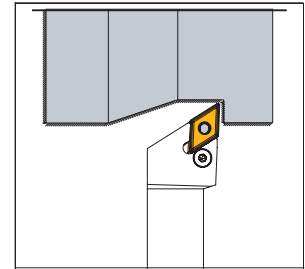
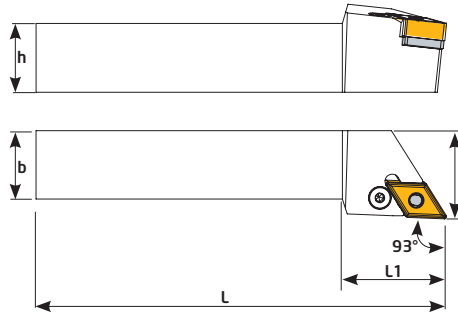
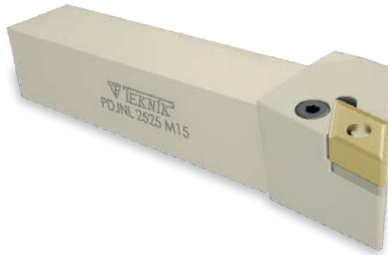

Sipariş Kodu Order Code Best.-Nr.	Stok/Stock/Lager	Ürün Kodu Product Code Produkt-Code	Ölçüler (mm) Dimensions(mm) Abmessungen (mm)						Uç Insert WSP	Sıkma Civatası Clamp Screw Klemm-Schraube	Altlık Shim U-Platte	Levye Sacı Lock Pin Rohrstift	Levye Lever Kniehebel	Anahtar Allen Key Inbuss-Schlüssel
			L	L1	h	f	b	kg						
P119	●	PDJNL 1616 H11	100	25	16	25	16	0,242	DNMG1104	TH613	TA013	TS-3	TL3	2,5 Allen
P120	●	PDJNL 2020 K11	125	30	20	25	20	0,435		TH617				
P121	●	PDJNL 2525 M11	150	30	25	32	25	0,767		TH822				
P122	●	PDJNL 2020 K15	125	35	20	25	20	0,402	DNMG1506	TH825	TA014-1	TS-4	TL4B	3 Allen
P124	●	PDJNL 2525 M15	150	38	25	32	25	0,730		TH825				
P126	●	PDJNL 3232 P15	170	38	32	40	32	1,384		TH825				



95° PCLNR

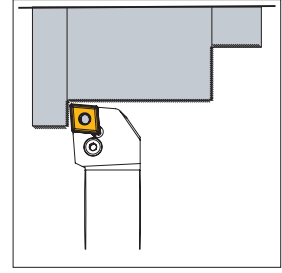
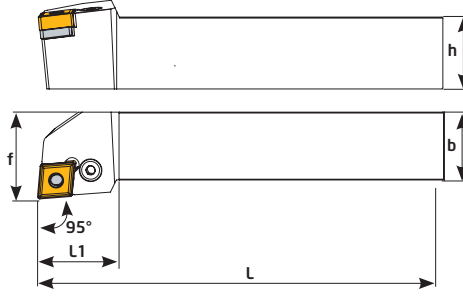

Sipariş Kodu Order Code Best.-Nr.	Stok/Stock/Lager	Ürün Kodu Product Code Produkt-Code	Ölçüler (mm) Dimensions(mm) Abmessungen (mm)						Uç Insert WSP	Sıkma Civatası Clamp Screw Klemm-Schraube	Altlık Shim U-Platte	Levye Sacı Lock Pin Rohrstift	Levye Lever Kniehebel	Anahtar Allen Key Inbuss-Schlüssel
			L	L1	h	f	b	kg						
P126-1	●	PCLNR 1616 H09	100	20	16	20	16	0,231	CNMG09T3	TH617	TA023	TS3	TL3	2,5 Allen
P127	●	PCLNR 2020 K09	125	22	20	25	20	0,428						
P128	●	PCLNR 2525 M09	150	22	25	32	25	0,785						
P129	●	PCLNR 1616 H12	100	30	16	20	16	0,225	CNMG1204	TH818	TA016-1	TS4	TL4	3 Allen
P130	●	PCLNR 2020 K12	125	30	20	25	20	0,421		TH821				
P132	●	PCLNR 2525 M12	150	30	25	32	25	0,766		TH821				
P134	●	PCLNR 3232 P12	170	30	32	40	32	1,429		TH821				

95° PCLNL

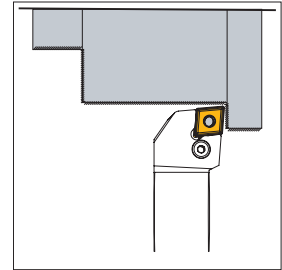
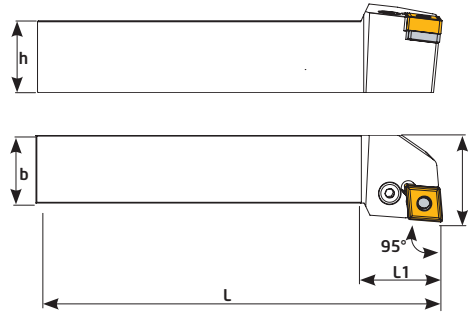

Sipariş Kodu Order Code Best.-Nr.	Stok/Stock/Lager	Ürün Kodu Product Code Produkt-Code	Ölçüler (mm) Dimensions(mm) Abmessungen (mm)						Uç Insert WSP	Sıkma Civatası Clamp Screw Klemm-Schraube	Altlık Shim U-Platte	Levye Sacı Lock Pin Rohrstift	Levye Lever Kniehebel	Anahtar Allen Key Inbuss-Schlüssel
			L	L1	h	f	b	kg						
P136	●	PCLNL 1616 H09	100	20	16	20	16	0,231	CNMG09T3	TH617	TA023	TS3	TL3	2,5 Allen
P137	●	PCLNL 2020 K09	125	22	20	25	20	0,428						
P138	●	PCLNL 2525 M09	150	22	25	32	25	0,785						
P139	●	PCLNL 1616 H12	100	30	16	20	16	0,225	CNMG1204	TH818	TA016-1	TS4	TL4	3 Allen
P140	●	PCLNL 2020 K12	125	30	20	25	20	0,421		TH821				
P142	●	PCLNL 2525 M12	150	30	25	32	25	0,766		TH821				
P144	●	PCLNL 3232 P12	170	30	32	40	32	1,429		TH821				

● Stokta/In Stock/Lager ○ Sınırlı Stok/Limited Stock/Begrenzte Lagerhaltung

95° PWLNR 08

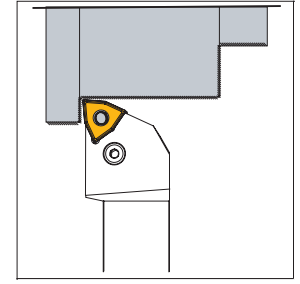
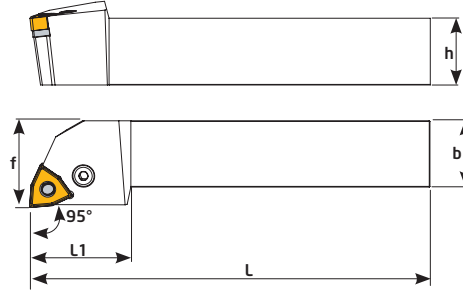
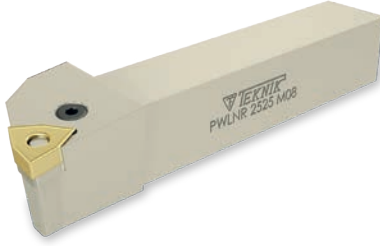

Sipariş Kodu Order Code Best.-Nr.	Stok/Stock/Lager	Ürün Kodu Product Code Produkt-Code	Ölçüler (mm) Dimensions(mm) Abmessungen (mm)						Uç Insert WSP	Sıkma Civatası Clamp Screw Klemm Schraube	Altlık Shim U-Platte	Levyeye Sacı Lock Pin Rohrstift	Levyeye Lever Kniehebel	Anahtar Allen Key Inbuss-Schlüssel
			L	L1	h	f	b	kg						
P150	●	PWLNR 2020 K08	125	30	20	25	20	0,430	WNMG 0804	TH821	TA020-1	TS4	TL4	3 Allen
P151	●	PWLNR 2525 M08	150	38	25	32	25	0,773						
P152	●	PWLNR 3232 P08	170	38	32	40	32	1,421						

95° PWLNL 08

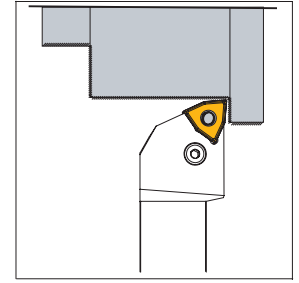
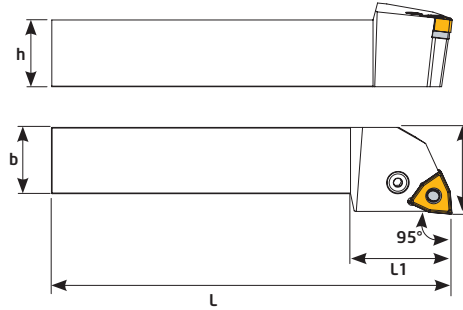
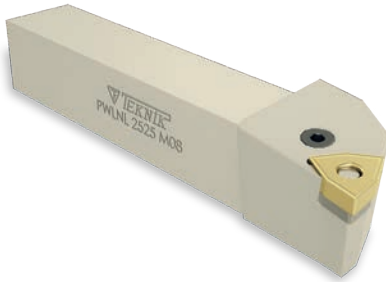

Sipariş Kodu Order Code Best.-Nr.	Stok/Stock/Lager	Ürün Kodu Product Code Produkt-Code	Ölçüler (mm) Dimensions(mm) Abmessungen (mm)						Uç Insert WSP	Sıkma Civatası Clamp Screw Klemm-Schraube	Altlık Shim U-Platte	Levyeye Sacı Lock Pin Rohrstift	Levyeye Lever Kniehebel	Anahtar Allen Key Inbuss-Schlüssel
			L	L1	h	f	b	kg						
P155	●	PWLNL 2020 K08	125	30	20	25	20	0,430	WNMG 0804	TH821	TA020-1	TS4	TL4	3 Allen
P156	●	PWLNL 2525 M08	150	38	25	32	25	0,773						
P157	●	PWLNL 3232 P08	170	38	32	40	32	1,421						



95° PWLNR 06

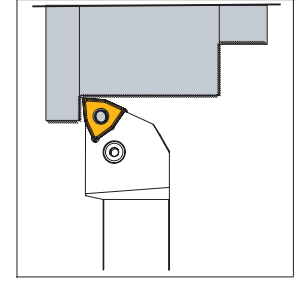
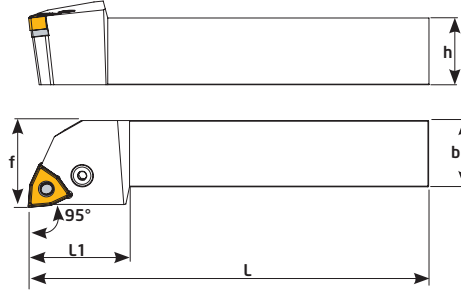
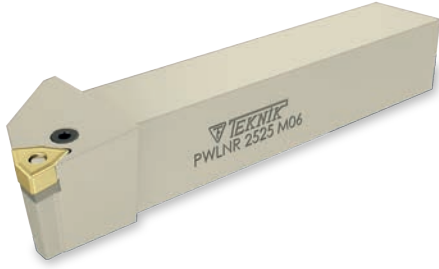

Sipariş Kodu Order Code Best.-Nr.	Stok/Stock/Lager	Ürün Kodu Product Code Produkt-Code	Ölçüler (mm) Dimensions(mm) Abmessungen (mm)						Uç Insert WSP	Sıkma Civatası Clamp Screw Klemm-Schraube	Altlık Shim U-Platte	Levye Sacı Lock Pin Rohrstift	Levye Lever Kniehebel	Anahtar Allen Key Inbuss-Schlüssel
			L	L1	h	f	b	kg						
P158	●	PWLNR 1616 H06	100	30	16	20	16	0,223	WNMG 0604	TH617	TA021	TS3	TL3	2,5 Allen
P160	●	PWLNR 2020 K06	125	30	20	25	20	0,429						
P161	●	PWLNR 2525 M06	150	30	25	32	25	0,758						

95° PWLNL 06

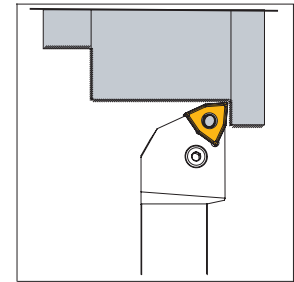
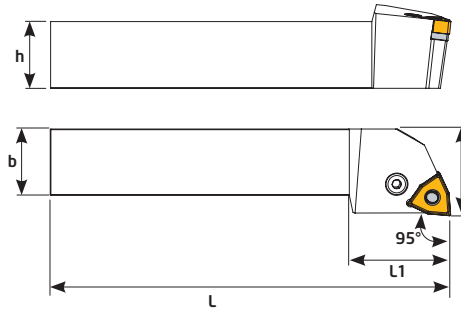

Sipariş Kodu Order Code Best.-Nr.	Stok/Stock/Lager	Ürün Kodu Product Code Produkt-Code	Ölçüler (mm) Dimensions(mm) Abmessungen (mm)						Uç Insert WSP	Sıkma Civatası Clamp Screw Klemm-Schraube	Altlık Shim U-Platte	Levye Sacı Lock Pin Rohrstift	Levye Lever Kniehebel	Anahtar Allen Key Inbuss-Schlüssel
			L	L1	h	f	b	kg						
P164	●	PWLNL 1616 H06	100	30	16	20	16	0,223	WNMG 0604	TH617	TA021	TS3	TL3	2,5 Allen
P165	●	PWLNL 2020 K06	125	30	20	25	20	0,429						
P166	●	PWLNL 2525 M06	150	30	25	32	25	0,758						

45° PSSNR

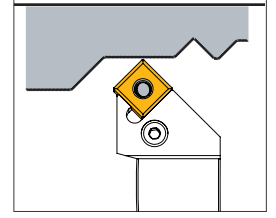
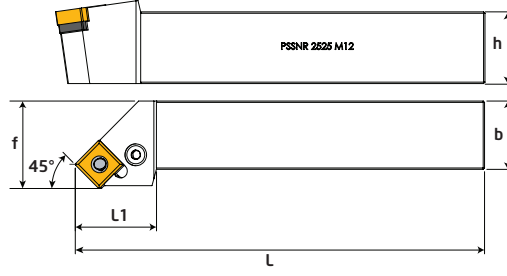

Sipariş Kodu Order Code Best.-Nr.	Stok/Stock/Lager	Ürün Kodu Product Code Produkt-Code	Ölçüler (mm) Dimensions(mm) Abmessungen (mm)						Uç Insert WSP	Sıkma Civatası Clamp Screw Klemm-Schraube	Altlık Shim U-Platte	Levye Sacı Lock Pin Rohrstift	Levye Lever Kniehebel	Anahtar Allen Key Inbuss-Schlüssel
			L	L1	h	f	b	kg						
P170	●	PSSNR 1616 H12	100	30	16	20	16	0,218	SNMG1204	TH818	TA050	TS4	TL4	3 Allen
P171	●	PSSNR 2020 K12	125	30	20	25	20	0,416		TH821				
P172	●	PSSNR 2525 M12	150	30	25	32	25	0,742						

45° PSSNL

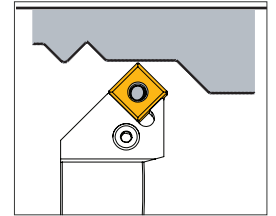
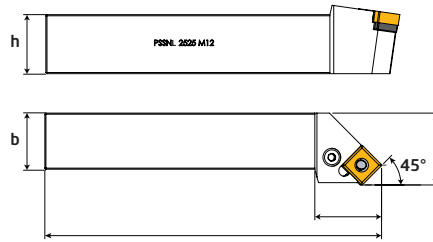

Sipariş Kodu Order Code Best.-Nr.	Stok/Stock/Lager	Ürün Kodu Product Code Produkt-Code	Ölçüler (mm) Dimensions(mm) Abmessungen (mm)						Uç Insert WSP	Sıkma Civatası Clamp Screw Klemm-Schraube	Altlık Shim U-Platte	Levye Sacı Lock Pin Rohrstift	Levye Lever Kniehebel	Anahtar Allen Key Inbuss-Schlüssel
			L	L1	h	f	b	kg						
P180	●	PSSNL 1616 H12	100	30	16	20	16	0,218	SNMG1204	TH818	TA050	TS4	TL4	3 Allen
P181	●	PSSNL 2020 K12	125	30	20	25	20	0,416		TH821				
P182	●	PSSNL 2525 M12	150	30	25	32	25	0,742						



D-M-C Sistem Dış Çap Kater
D-M-C System External Turning Holder
D-M-C System Klemmhalter

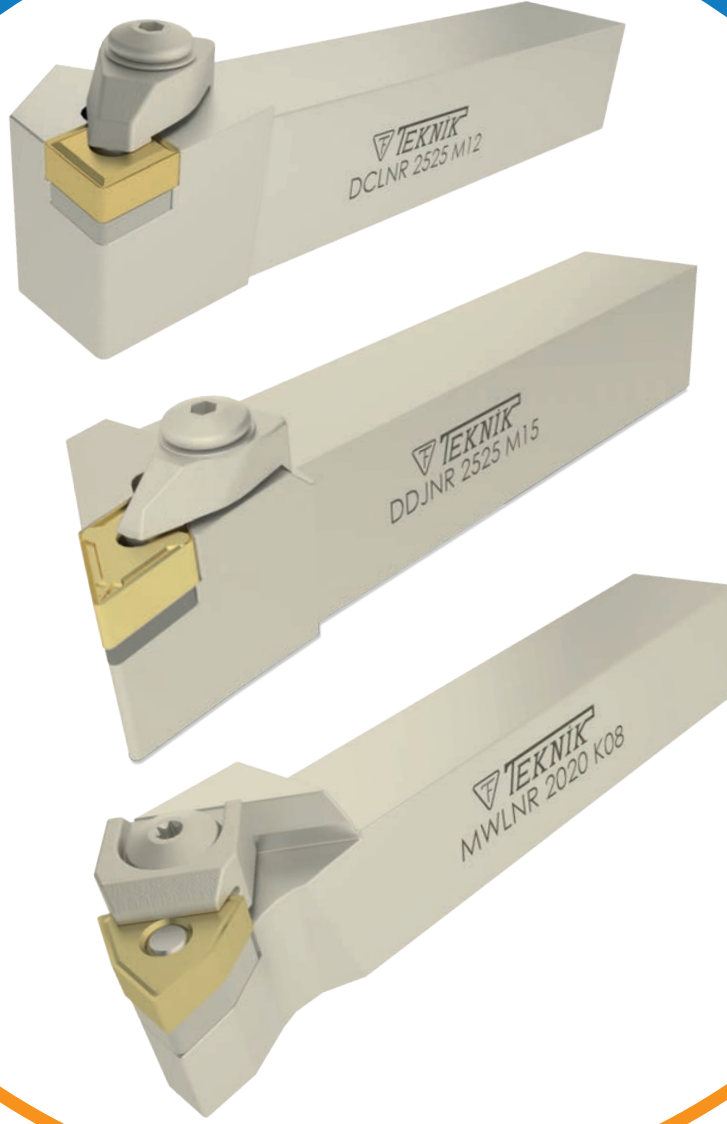

**Technical Solution
for Quality**



93° DDJNR

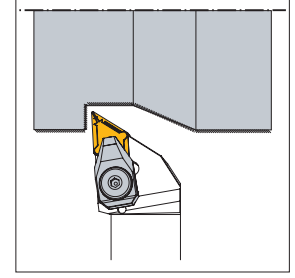
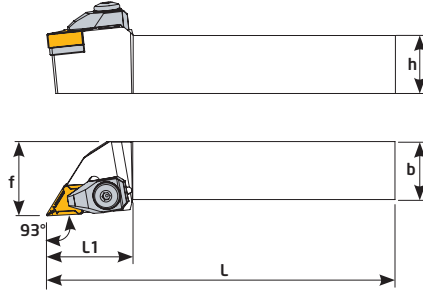
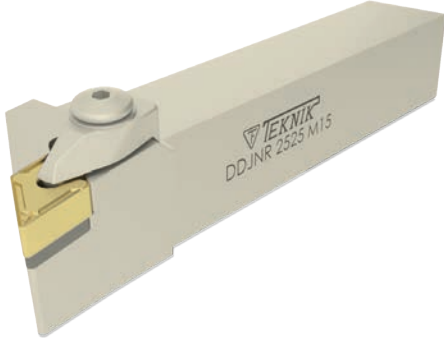

Sipariş Kodu Order Code Best.-Nr.	Stok/Stock/Lager	Ürün Kodu Product Code Produkt-Code	Ölçüler (mm) Dimensions(mm) Abmessungen (mm)							Uç Insert WSP	Baskı Civatası Locking Screw Verriegelungs Schraube	Altlık Shim U-Platte	Altlık Civatası Shim Screw U-Platte Schraube	Baskı Kepi Clamp Spann- pratze	Yay Spring Feder	Pul Washer U-Scheibe	Anahtar Allen Key Inbuss-Schlüs- sel
			L	L1	h	f	b	kg									
D167	●	DDJNR 2020 K11	125	30	20	25	20	0,421	DN-- 1104	TC046 M5	TA013	TC034 M3x7	BK024	BY041	BSP031	3 Allen	
D168	●	DDJNR 2525 M11	150	30	25	32	25	0,751									
D170	●	DDJNR 2020 K15	125	35	20	25	20	0,425	DN-- 1506	TC044 M6	TA014-1	TC038 M4x10	BK020	BY040	BSP030	3 Allen	
D172	●	DDJNR 2525 M15	150	35	25	32	25	0,756									
D174	●	DDJNR 3232 P15	170	35	32	40	32	1,345									

93° DDJNL

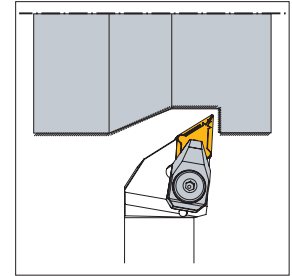
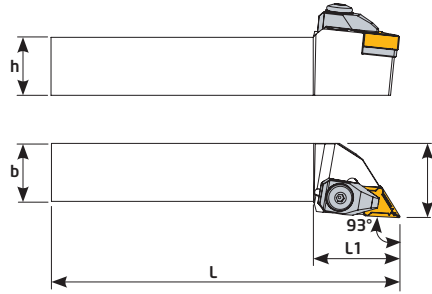
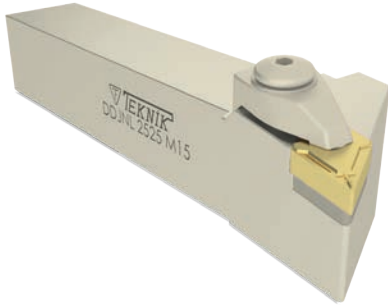

Sipariş Kodu Order Code Best.-Nr.	Stok/Stock/Lager	Ürün Kodu Product Code Produkt-Code	Ölçüler (mm) Dimensions(mm) Abmessungen (mm)							Uç Insert WSP	Baskı Civatası Locking Screw Verriegelungs Schraube	Altlık Shim U-Platte	Altlık Civatası Shim Screw U-Platte Schraube	Baskı Kepi Clamp Spann- pratze	Yay Spring Feder	Pul Washer U-Scheibe	Anahtar Allen Key Inbuss-Schlüs- sel
			L	L1	h	f	b	kg									
D307-1	●	DDJNL 2020 K11	125	30	20	25	20	0,421	DN-- 1104	TC046 M5	TA013	TC034 M3x7	BK024	BY041	BSP031	3 Allen	
D308	●	DDJNL 2525 M11	150	30	25	32	25	0,751									
D310	●	DDJNL 2020 K15	125	35	20	25	20	0,425	DN-- 1506	TC044 M6	TA014-1	TC038 M4x10	BK020	BY040	BSP030	3 Allen	
D312	●	DDJNL 2525 M15	150	35	25	32	25	0,756									
D314	●	DDJNL 3232 P15	170	35	32	40	32	1,345									



93° DDJNR

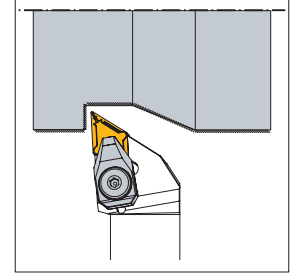
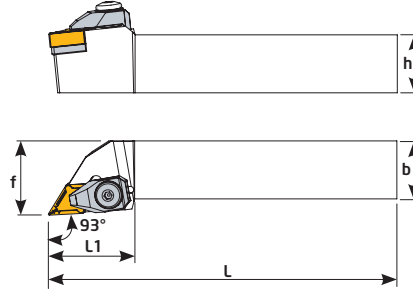
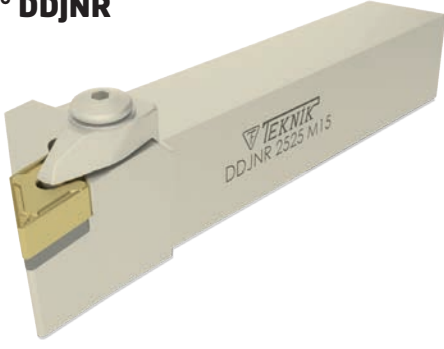

Sipariş Kodu Order Code Best.-Nr.	Stok/Stock/Lager	Ürün Kodu Product Code Produkt-Code	Ölçüler (mm) Dimensions(mm) Abmessungen (mm)						Uç Insert WSP	Baskı Civatası Locking Screw Verriegelungs Schraube	Altlık Shim U-Platte	Altlık Civatası Shim Screw U-Platte Schraube	Baskı Kepi Clamp Spann- pratze	Yay Spring Feder	Pul Washer U-Scheibe	Anahtar Allen Key Inbuss-Schlüssel
			L	L1	h	f	b	kg								
D171	●	DDJNR 2020 K15	125	38	20	25	20	0,426	DN-- 1504	TC044 M6	TA014-1	TC038 M4x10	BK020	BY040	BSP030	3 Allen
D169	●	DDJNR 2525 M15	150	38	25	32	25	0,763								

93° DDJNL

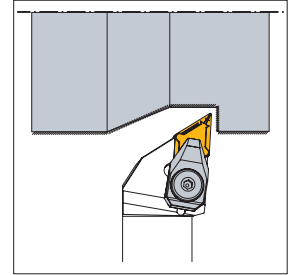
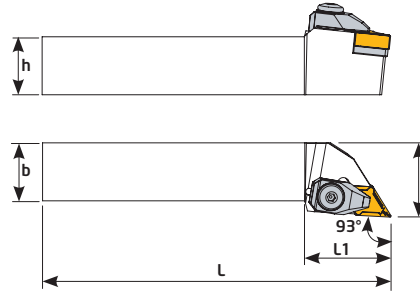
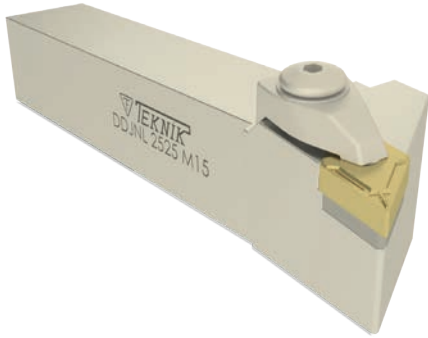

Sipariş Kodu Order Code Best.-Nr.	Stok/Stock/Lager	Ürün Kodu Product Code Produkt-Code	Ölçüler (mm) Dimensions(mm) Abmessungen (mm)						Uç Insert WSP	Baskı Civatası Locking Screw Verriegelungs Schraube	Altlık Shim U-Platte	Altlık Civatası Shim Screw U-Platte Schraube	Baskı Kepi Clamp Spann- pratze	Yay Spring Feder	Pul Washer U-Scheibe	Anahtar Allen Key Inbuss-Schlüssel
			L	L1	h	f	b	kg								
D313	●	DDJNL 2020 K15	125	38	20	25	20	0,426	DN-- 1504	TC044 M6	TA014-1	TC038 M4x10	BK020	BY040	BSP030	3 Allen
D309	●	DDJNL 2525 M15	150	38	25	32	25	0,763								

107,5° DDHNR

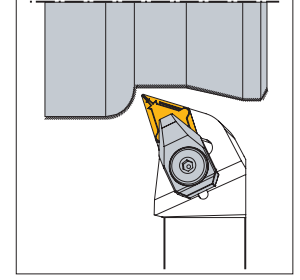
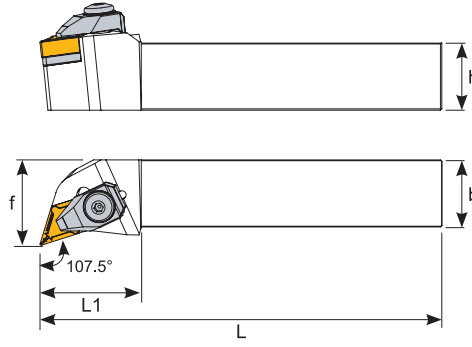

Sipariş Kodu Order Code Best.-Nr.	Stok/Stock/Lager	Ürün Kodu Product Code Produkt-Code	Ölçüler (mm) Dimensions(mm) Abmessungen (mm)							Uç Insert WSP	Baskı Civatası Locking Screw Verriegelungs Schraube	Altık Shim U-Platte	Altık Civatası Shim Screw U-Platte Schraube	Baskı Kepi Clamp Spann- pratze	Yay Spring Feder	Pul Washer U-Scheibe	Anahtar Allen Key Inbuss-Schlüs- sel
			L	L1	h	f	b	kg									
D096	●	DDHNR 2020 K15	125	33	20	25	20	0,428	DN-- 1506	TC044 M6	TA014-1	TC038 M4x10	BK020	BY040	BSP030	3 Allen	
D097	●	DDHNR 2525 M15	150	33	25	32	25	0,753									
D098	●	DDHNR 3232 P15	170	33	32	40	32	1,290									

107,5° DDHNL

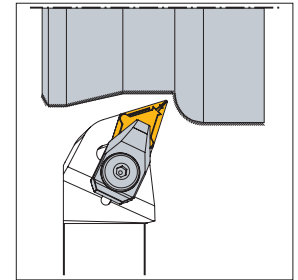
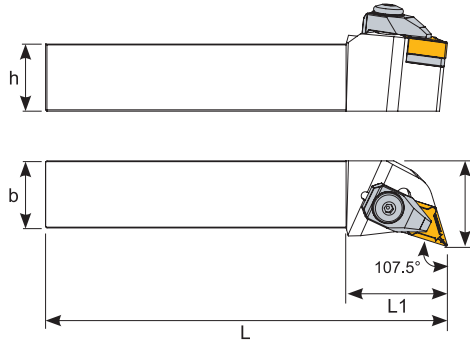

Sipariş Kodu Order Code Best.-Nr.	Stok/Stock/Lager	Ürün Kodu Product Code Produkt-Code	Ölçüler (mm) Dimensions(mm) Abmessungen (mm)							Uç Insert WSP	Baskı Civatası Locking Screw Verriegelungs Schraube	Altık Shim U-Platte	Altık Civatası Shim Screw U-Platte Schraube	Baskı Kepi Clamp Spann- pratze	Yay Spring Feder	Pul Washer U-Scheibe	Anahtar Allen Key Inbuss-Schlüs- sel
			L	L1	h	f	b	kg									
D295	●	DDHNL 2020 K15	125	33	20	25	20	0,428	DN-- 1506	TC044 M6	TA014-1	TC038 M4x10	BK020	BY040	BSP030	3 Allen	
D296	●	DDHNL 2525 M15	150	33	25	32	25	0,753									
D297	●	DDHNL 3232 P15	170	33	32	40	32	1,290									



62,5° DDNNN

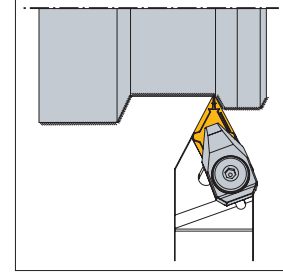
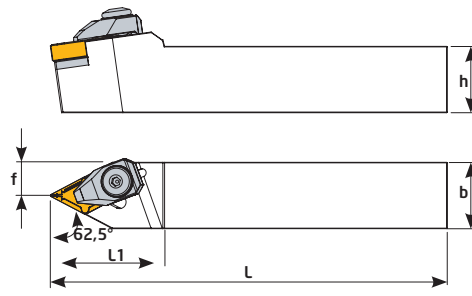

Sipariş Kodu Order Code Best.-Nr.	Stok/Stock/Lager	Ürün Kodu Product Code Produkt-Code	Ölçüler (mm) Dimensions(mm) Abmessungen (mm)						Uç Insert WSP	Baskı Civatası Locking Screw Verriegelungs Schraube	Altılık Shim U-Platte	Altılık Civatası Shim Screw U-Platte Schraube	Baskı Kipi Clamp Spann pratze	Yay Spring Feder	Pul Washer U-Scheibe	Anahtar Allen Key Inbuss-Schlüs- sel
			L	L1	h	f	b	kg								
D104	●	DDNNN 2020 K15	125	40	20	10	20	0,404	DN-- 1506	TC044 M6	TA014-1	TC038 M4x10	BK020	BY040	BSP030	3 Allen
D106	●	DDNNN 2525 M15	150	40	25	12,5	25	0,724								
D109	●	DDNNN 3232 P15	170	40	32	16	32	1,290								

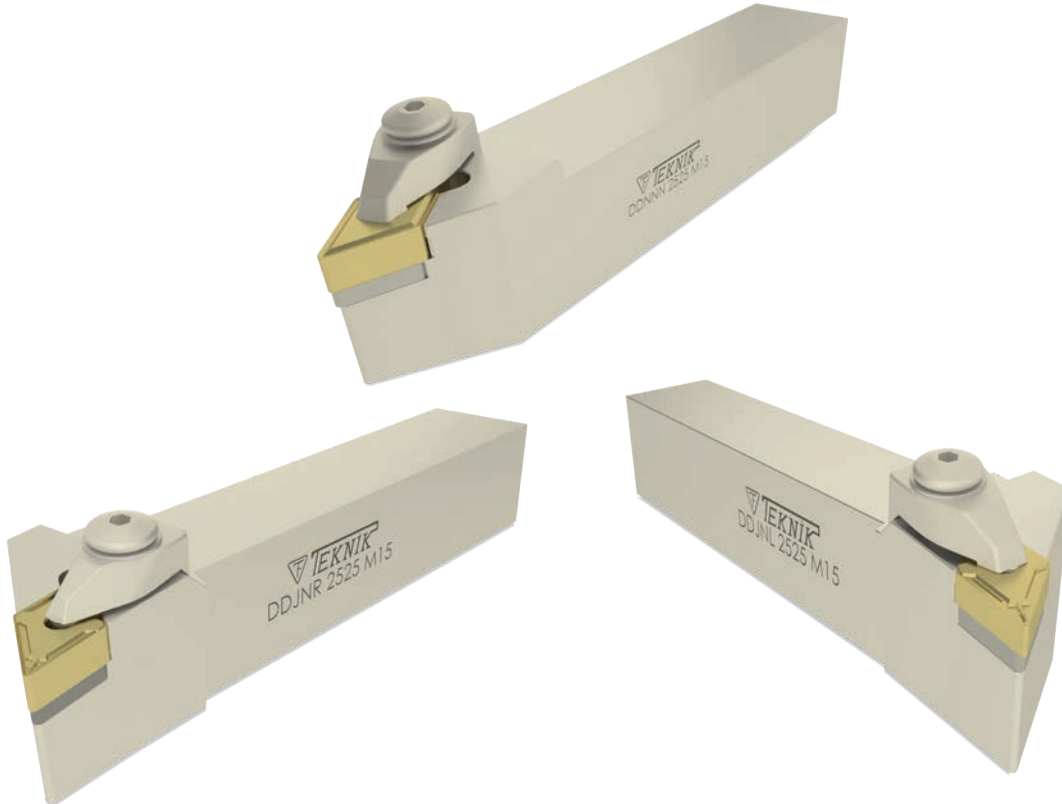

● Stokta/ In Stock/ Lager ○ Sınırlı Stok/ Limited Stock/ Begrenzte Lagerhaltung

Kalite için Teknik Çözüm | Technical Solution For Quality

BROTECH

TEKNİK
Cutting Tools

www.teknikcuttingtools.com

145

95° DCLNR

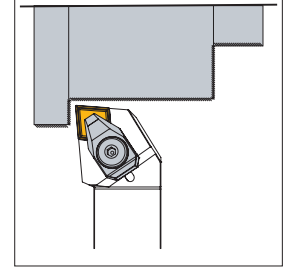
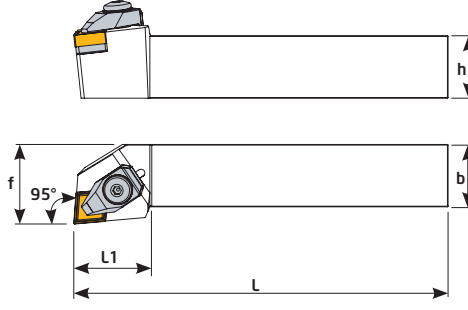
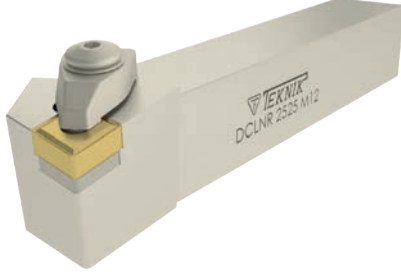

Sipariş Kodu Order Code Best.-Nr.	Stok/Stock/Lager	Ürün Kodu Product Code Produkt-Code	Ölçüler (mm) Dimensions(mm) Abmessungen (mm)						Uç Insert WSP	Altlık Shim U-Platte	Altlık Civatası Shim Screw U-Platte Schraube	Baskı Kepi Clamp Spannpratze	Baskı Civatası Locking Screw Verriegelungs Schraube	Yay Spring Feder	Pul Washer U-Scheibe	Anahtar Allen Key In- buss-Schlüs- sel
			L	L1	h	f	b	⊗								
D160	●	DCLNR 2020 K12	125	30	20	25	20	0,441	CN-- 1204	TA016-1	TC038 M4x10	BK020	TC044 M6	BY040	BSP030	3 Allen
D162	●	DCLNR 2525 M12	150	30	25	32	25	0,785								
D164	●	DCLNR 3232 P12	170	30	32	40	32	1,379	CN-- 1606	TA022	TC095 M5x11,8	BK018	TC044 M6	BY040	BSP030	3 Allen
D162-1	●	DCLNR 2525 M16	150	36	25	32	25	0,432								
D165	●	DCLNR 3232 P16	170	36	32	40	32	1,407	CN-- 1906	TA017	TC039 M6x12	BK025	TC047 M8	BY044	BSP032	5 Allen
D163	●	DCLNR 2525 M19	150	40	25	32	25	0,820								
D166	●	DCLNR 3232 P19	170	40	32	40	32	1,430	CN-- 1906	TA017	TC039 M6x12	BK025	TC047 M8	BY044	BSP032	5 Allen
D166-1	●	DCLNR 4040 S19	250	40	40	40	40	3,195								

95° DCLNL

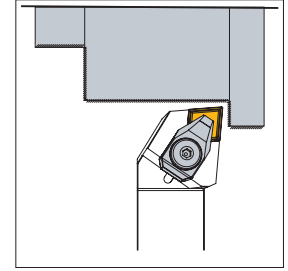
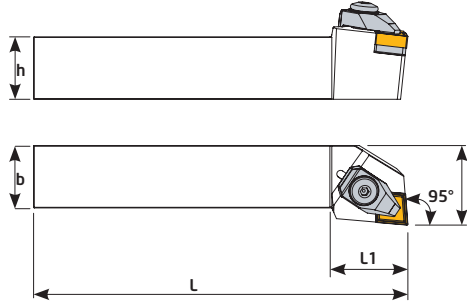
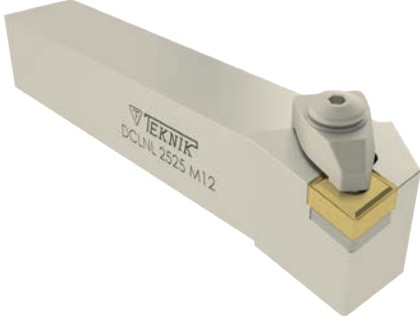

Sipariş Kodu Order Code Best.-Nr.	Stok/Stock/Lager	Ürün Kodu Product Code Produkt-Code	Ölçüler (mm) Dimensions(mm) Abmessungen (mm)						Uç Insert WSP	Altlık Shim U-Platte	Altlık Civatası Shim Screw U-Platte Schraube	Baskı Kepi Clamp Spannpratze	Baskı Civatası Locking Screw Verriegelungs Schraube	Yay Spring Feder	Pul Washer U-Schei- be	Anahtar Allen Key Inbuss-Schlüs- sel
			L	L1	h	f	b	⊗								
D301	●	DCLNL 2020 K12	125	30	20	25	20	0,441	CN-- 1204	TA016-1	TC038 M4x10	BK020	TC044 M6	BY040	BSP030	3 Allen
D302	●	DCLNL 2525 M12	150	30	25	32	25	0,785								
D305	●	DCLNL 3232 P12	170	30	32	40	32	1,379	CN-- 1606	TA022	TC095 M5x11,8	BK018	TC044 M6	BY040	BSP030	3 Allen
D303	●	DCLNL 2525 M16	150	36	25	32	25	0,432								
D306	●	DCLNL 3232 P16	170	36	32	40	32	1,407	CN-- 1906	TA017	TC039 M6x12	BK025	TC047 M8	BY044	BSP032	5 Allen
D304	●	DCLNL 2525 M19	150	40	25	32	25	0,820								
D307	●	DCLNL 3232 P19	170	40	32	40	32	1,430	CN-- 1906	TA017	TC039 M6x12	BK025	TC047 M8	BY044	BSP032	5 Allen
D307-2	●	DCLNL 4040 S19	250	40	40	40	40	3,195								



50° DCMNN

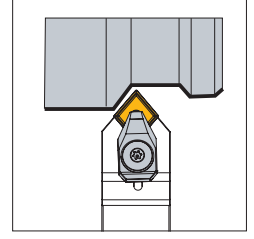
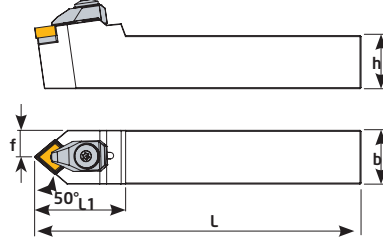

Sipariş Kodu Order Code Best.-Nr.	Stok/Stock/Lager	Ürün Kodu Product Code Produkt-Code	Ölçüler (mm) Dimensions(mm) Abmessungen (mm)							Uç Insert WSP	Baskı Civatası Locking Screw Verriegelungs Schraube	Altlık Shim U-Platte	Altlık Civatası Shim Screw U-Platte Schraube	Baskı Keps Clamp Spann pratze	Yay Spring Feder	Pul Washer U-Scheibe	Anahtar Allen Key Inbuss-Schlüssel
			L	L1	h	f	b	kg									
D214-1	●	DCMNN 2020 K12	125	35	20	10	20	0,445	CN-- 1204	TC044 M6	TA016-1	TC038 M4x10	BK020	BY040	BSP030	3 Allen	
D215	●	DCMNN 2525 M12	150	42	25	12,5	25	0,778									

40° DCXNN

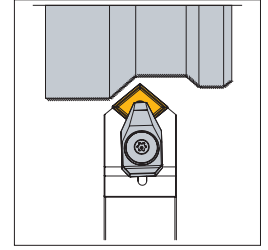
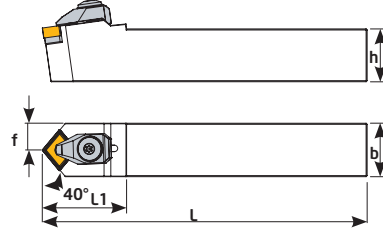

Sipariş Kodu Order Code Best.-Nr.	Stok/Stock/Lager	Ürün Kodu Product Code Produkt-Code	Ölçüler (mm) Dimensions(mm) Abmessungen (mm)							Uç Insert WSP	Baskı Civatası Locking Screw Verriegelungs Schraube	Altlık Shim U-Platte	Altlık Civatası Shim Screw U-Platte Schraube	Baskı Keps Clamp Spann pratze	Yay Spring Feder	Pul Washer U-Scheibe	Anahtar Allen Key Inbuss-Schlüssel
			L	L1	h	f	b	kg									
D216	●	DCXNN 2525 M12	150	35	25	12,5	25	0,756	CN-- 1204	TC044 M6	TA016-1	TC038 M4x10	BK020	BY040	BSP030	3 Allen	

75° DCKNR

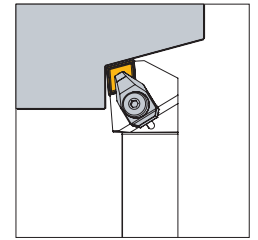
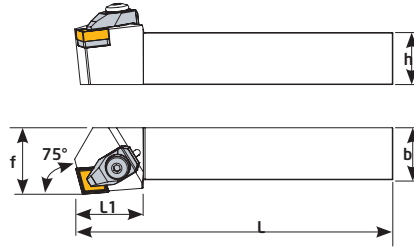

Sipariş Kodu Order Code Best.-Nr.	Stok/Stock/Lager	Ürün Kodu Product Code Produkt-Code	Ölçüler (mm) Dimensions(mm) Abmessungen (mm)							Uç Insert WSP	Altlık Shim U-Platte	Altlık Civatası Shim Screw U-Platte Schraube	Baskı Keps Clamp Spann pratze	Baskı Civatası Locking Screw Verriegelungs Schraube	Yay Spring Feder	Pul Washer U-Scheibe	Anahtar Allen Key In- buss-Schlüs- sel
			L	L1	h	f	b	kg									
D116-1	●	DCKNR 2525 M12	150	30	25	32	25	0,440	CNMG 1204	TA016-1	TC038 M4x10	BK020	TC044 M6	BY040	BSP030	3 Allen	
D162-3	●	DCKNR 2525 M16	150	40	25	32	25	0,576	CNMG 1606	TA022	TC095 M5x11,8	BK018					

● Stokta/In Stock/Lager ○ Sınırlı Stok/Limited Stock/Begrenzte Lagerhaltung

Kalite için Teknik Çözüm | Technical Solution For Quality



www.teknikcuttingtools.com

45° DCSNR

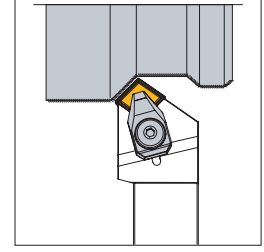
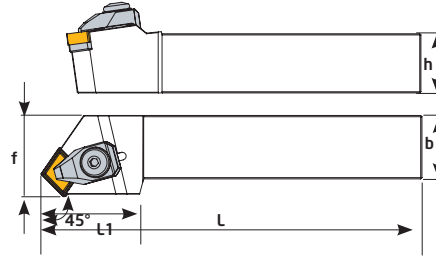

Sipariş Kodu Order Code Best.-Nr.	Stok/Stock/Lager	Ürün Kodu Product Code Produkt-Code	Ölçüler (mm) Dimensions(mm) Abmessungen (mm)						Uç Insert WSP	Altlık Shim U-Platte	Altlık Cıvatası Shim Screw U-Platte Schraube	Baskı Kepi Clamp Spannpratze	Baskı Cıvatası Locking Screw Verriegelungs Schraube	Yay Spring Feder	Pul Washer U-Scheibe	Anahtar Allen Key In- buss-Schlüs- sel
			L	L1	h	f	b	kg								
D218	●	DCSNR 2525 M12	150	35	25	32	25	0,774	CNMG 1204	TA016-1	TC038 M4x10	BK020	TC044 M6	BY040	BSP030	3 Allen

45° DSSNR

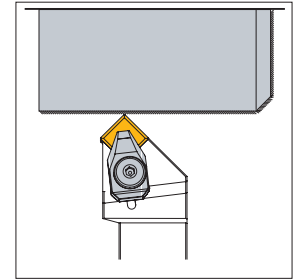
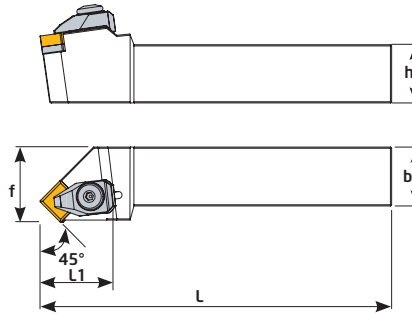

Sipariş Kodu Order Code Best.-Nr.	Stok/Stock/Lager	Ürün Kodu Product Code Produkt-Code	Ölçüler (mm) Dimensions(mm) Abmessungen (mm)						Uç Insert WSP	Altlık Shim U-Platte	Altlık Cıvatası Shim Screw U-Platte Schraube	Baskı Kepi Clamp Spannpratze	Baskı Cıvatası Locking Screw Verriegelungs Schraube	Yay Spring Feder	Pul Washer U-Scheibe	Anahtar Allen Key In- buss-Schlüs- sel
			L	L1	h	f	b	kg								
D210	●	DSSNR 2020 K12	125	35	20	25	20	0,440	SNMG 1204	TA050	TC038 M4x10	BK020	TC044 M6	BY040	BSP030	3 Allen
D212	●	DSSNR 2525 M12	150	35	25	32	25	0,576								
D205	●	DSSNR 3232 P12	170	36	32	32	40	1,280								
D206	●	DSSNR 3232 P19	170	46	32	32	40	1,383	SNMG 1906	TA051	TC039 M6x12	BK025	TC047 M8	BY044	BSP032	5 Allen
D207	●	DSSNR 4040 S19	250	46	40	40	50	3,123								
D208	●	DSSNR 4040 S25	250	60	40	40	50	3,012								



95° DWLNR

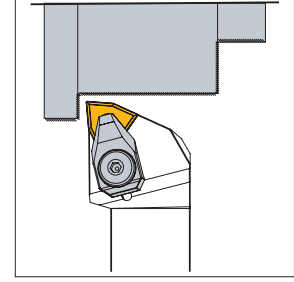
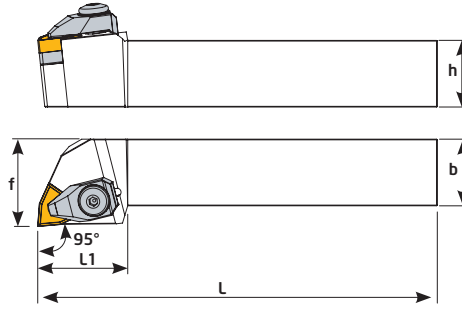

Sipariş Kodu Order Code Best.-Nr.	Stok/Stock/Lager	Ürün Kodu Product Code Produkt-Code	Ölçüler (mm) Dimensions(mm) Abmessungen (mm)							Uç Insert WSP	Baskı Civatası Locking Screw Verriegelungs Schraube	Altlık Shim U-Platte	Altlık Civatası Shim Screw U-Platte Schraube	Baskı Kepi Clamp Spannpratze	Yay Spring Feder	Pul Washer U-Scheibe	Anahtar Allen Key In-buss-Schlüssel
			L	L1	h	f	b	kg									
D181	●	DWLNR 1616 H06	100	26	16	20	16	0,229	WN--0604	TC046 M5	TA021	TC034 M3x7	BK024	BY041	BSP031	3 Allen	
D177	●	DWLNR 2020 K06	125	26	20	25	20	0,436									
D179	●	DWLNR 2525 M06	150	26	25	32	25	0,772									
D176	●	DWLNR 2020 K08	125	32	20	25	20	0,442	WN--0804	TC044 M6	TA020-1	TC038 M4x10	BK020	BY040	BSP030	3 Allen	
D178	●	DWLNR 2525 M08	150	32	25	32	25	0,793									
D180	●	DWLNR 3232 P08	170	32	32	40	32	1,377									

95° DWLNL

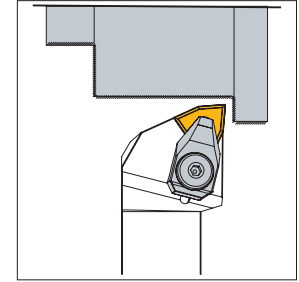
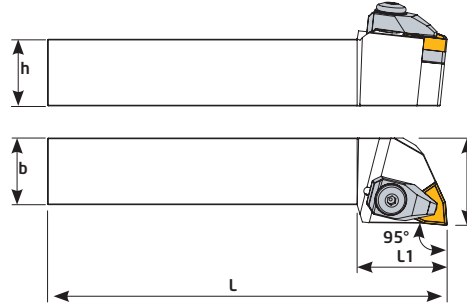

Sipariş Kodu Order Code Best.-Nr.	Stok/Stock/Lager	Ürün Kodu Product Code Produkt-Code	Ölçüler (mm) Dimensions(mm) Abmessungen (mm)							Uç Insert WSP	Baskı Civatası Locking Screw Verriegelungs Schraube	Altlık Shim U-Platte	Altlık Civatası Shim Screw U-Platte Schraube	Baskı Kepi Clamp Spannpratze	Yay Spring Feder	Pul Washer U-Scheibe	Anahtar Allen Key In-buss-Schlüssel
			L	L1	h	f	b	kg									
D328	●	DWLNL 1616 H06	100	26	16	20	16	0,229	WN--0604	TC046 M5	TA021	TC034 M3x7	BK024	BY041	BSP031	3 Allen	
D329	●	DWLNL 2020 K06	125	26	20	25	20	0,436									
D319	●	DWLNL 2525 M06	150	26	25	32	25	0,772									
D316	●	DWLNL 2020 K08	125	32	20	25	20	0,442	WN--0804	TC044 M6	TA020-1	TC038 M4x10	BK020	BY040	BSP030	3 Allen	
D318	●	DWLNL 2525 M08	150	32	25	32	25	0,793									
D320	●	DWLNL 3232 P08	170	32	32	40	32	1,377									

● Stokta/In Stock/Lager ○ Sınırlı Stok/Limited Stock/Begrenzte Lagerhaltung

Kalite için Teknik Çözüm | Technical Solution For Quality

BROTECH

TEKNİK
Cutting Tools

www.teknikcuttingtools.com

149

95° MWLNR

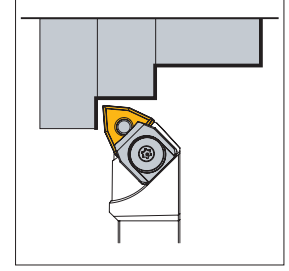
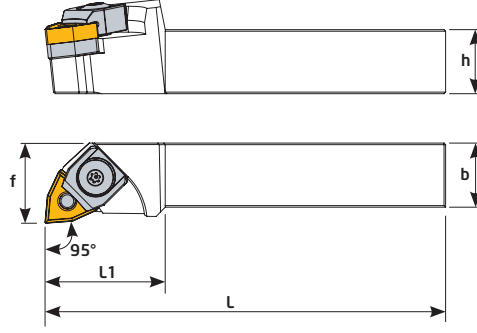

Sipariş Kodu Order Code Best.-Nr.	Stok/Stock/Lager	Ürün Kodu Product Code Produkt-Code	Ölçüler (mm) Dimensions (mm) Abmessungen (mm)						Uç Insert WSP	Baskı Civatası Locking Screw Verriegelungs Schraube	Altlık Shim U-Platte	Altlık Pimi Lock Pin Rohrstift	Baskı Kepi Clamp Spann pratze	Yay Spring Feder	Pul Washer U-Scheibe	Anahtar Allen Key Inbuss-Schlüssel
			L	L1	h	f	b	kg								
D182	●	MWLNR 2020 K08	125	35	20	25	20	0,435	WN-- 0804	TC044 M6	TA020	BSP021	BK026	BY040	BSP030	3 Allen
D184	●	MWLNR 2525 M08	150	35	25	32	25	0,761								
D185	●	MWLNR 3232 P08	170	35	32	40	32	1,349								

95° MWLNL

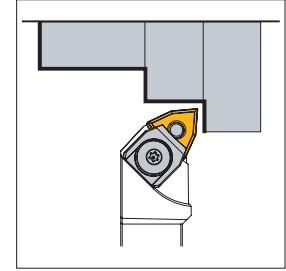
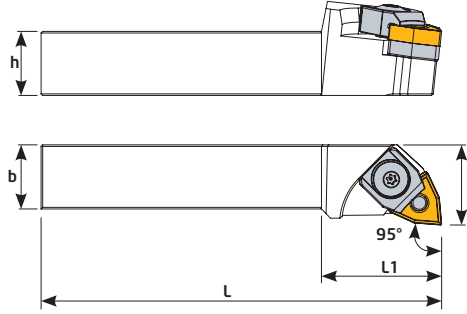
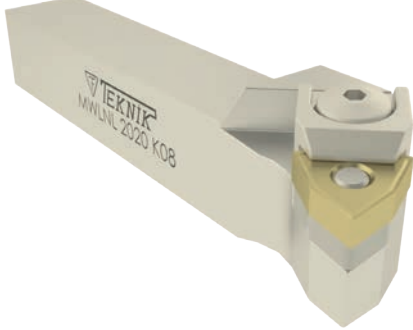

Sipariş Kodu Order Code Best.-Nr.	Stok/Stock/Lager	Ürün Kodu Product Code Produkt-Code	Ölçüler (mm) Dimensions (mm) Abmessungen (mm)						Uç Insert WSP	Baskı Civatası Locking Screw Verriegelungs Schraube	Altlık Shim U-Platte	Altlık Pimi Lock Pin Rohrstift	Baskı Kepi Clamp Spann pratze	Yay Spring Feder	Pul Washer U-Scheibe	Anahtar Allen Key Inbuss-Schlüssel
			L	L1	h	f	b	kg								
D322	●	MWLNL 2020 K08	125	35	20	25	20	0,435	WN-- 0804	TC044 M6	TA020	BSP021	BK026	BY040	BSP030	3 Allen
D324	●	MWLNL 2525 M08	150	35	25	32	25	0,761								
D326	●	MWLNL 3232 P08	170	35	32	40	32	1,349								



95° MWMNN

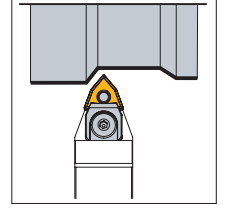
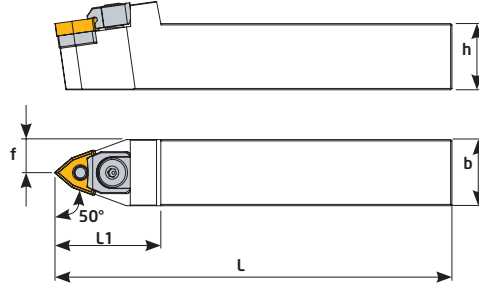
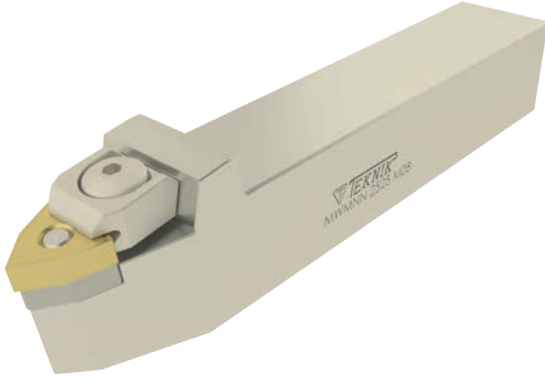

Sipariş Kodu Order Code Best.-Nr.	Stok/Lager	Ürün Kodu Product Code Produkt-Code	Ölçüler (mm) Dimensions (mm) Abmessungen (mm)						Uç Insert WSP	Baskı Civatası Locking Screw Verriegelungs Schraube	Altlık Shim U-Platte	Altlık Pimi Lock Pin Rohrstift	Baskı Kepi Clamp Spann- pratze	Yay Spring Feder	Pul Washer U-Schei- be	Anahtar Allen Key Inbuss-Schlüssel
			L	L1	h	f	b	kg								
D114	●	MWMNN 2020 K08	125	40	20	10	20	0,432	WN-- 0804	TC044 M6	TA020	BSP021	BK026	BY040	BSP030	3 Allen
D116	●	MWMNN 2525 M08	150	40	25	12,5	25	0,724								

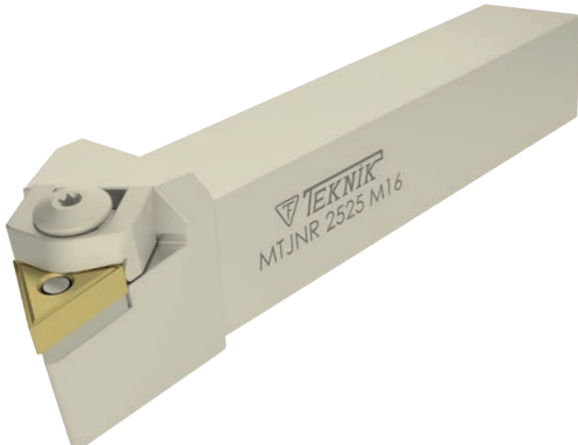
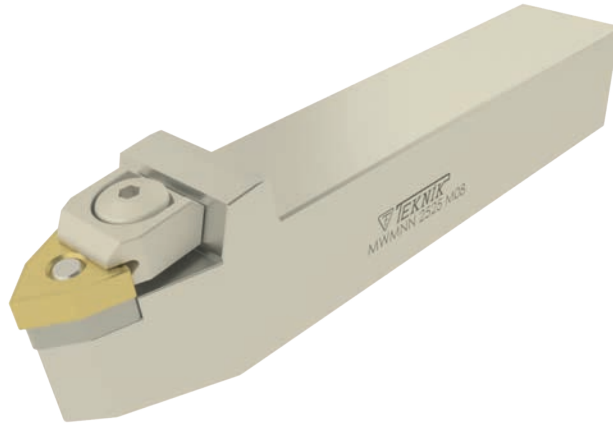

93° MTJNR

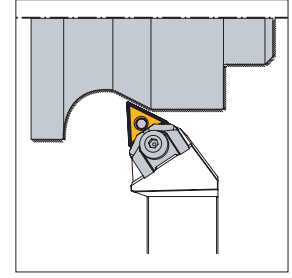
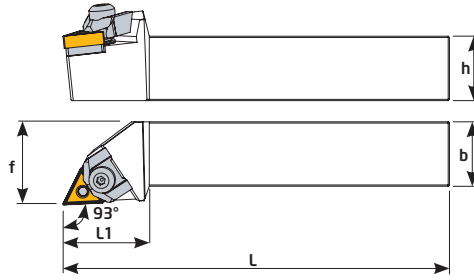

Sipariş Kodu Order Code Best.-Nr.	Stok/Stock/Lager	Ürün Kodu Product Code Produkt-Code	Ölçüler (mm) Dimensions(mm) Abmessungen (mm)							Uç Insert WSP	Baskı Civatası Locking Screw Verriegelungs Schraube	Altlık Shim U-Platte	Altlık Pimi Lock Pin Rohrstift	Baskı Kepi Clamp Spann- pratze	Yay Spring Feder	Pul Washer U-Scheibe	Anahtar Allen Key Inbuss-Schlüs- sel
			L	L1	h	f	b	KG									
D194	●	MTJNR 2020 K16	125	35	20	25	20	0,429	TN-- 1604	TC046 M5	TA019	BSP020	BK022	BY043	BSP031	3 Allen	
D196	●	MTJNR 2525 M16	150	35	25	32	25	0,760									
D198	●	MTJNR 3232 P16	170	35	32	40	32	1,360									
D200	●	MTJNR 2020 K22	125	40	20	25	20	0,429	TN-- 2204	TC044 M6	TA045	BSP021	BK023	BY040	BSP030	3 Allen	
D202	●	MTJNR 2525 M22	150	40	25	32	25	0,775									
D204	●	MTJNR 3232 P22	170	40	32	40	32	1,348									

93° MTJNL

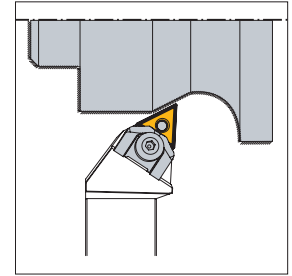
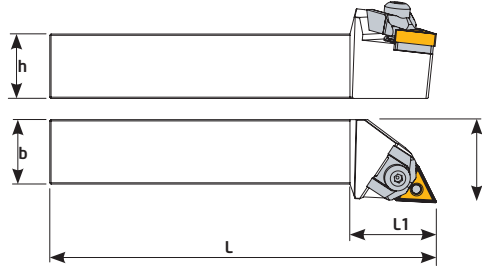

Sipariş Kodu Order Code Best.-Nr.	Stok/Stock/Lager	Ürün Kodu Product Code Produkt-Code	Ölçüler (mm) Dimensions(mm) Abmessungen (mm)							Uç Insert WSP	Baskı Civatası Locking Screw Verriegelungs Schraube	Altlık Shim U-Platte	Altlık Pimi Lock Pin Rohrstift	Baskı Kepi Clamp Spann- pratze	Yay Spring Feder	Pul Washer U-Schei- be	Anahtar Allen Key In- buss-Schlüs- sel
			L	L1	h	f	b	KG									
D332	●	MTJNL 2020 K16	125	35	20	25	20	0,429	TN-- 1604	TC046 M5	TA019	BSP020	BK022	BY043	BSP031	3 Allen	
D334	●	MTJNL 2525 M16	150	35	25	32	25	0,760									
D336	●	MTJNL 3232 P16	170	35	32	40	32	1,360									
D338	●	MTJNL 2020 K22	125	40	20	25	20	0,429	TN-- 2204	TC044 M6	TA045	BSP021	BK023	BY040	BSP030	3 Allen	
D340	●	MTJNL 2525 M22	150	40	25	32	25	0,775									
D342	●	MTJNL 3232 P22	170	40	32	40	32	1,348									



60° MTENN

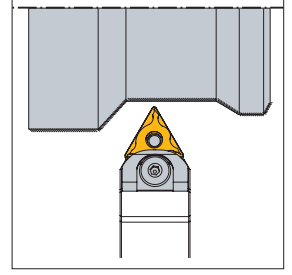
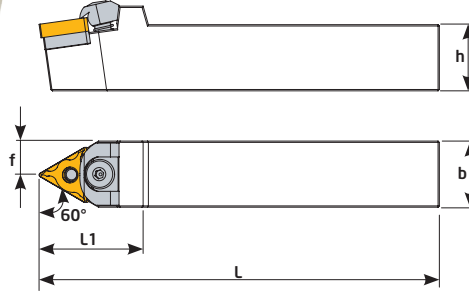

Sipariş Kodu Order Code Best.-Nr.	Stok/Stock/Lager	Ürün Kodu Product Code Produkt-Code	Ölçüler (mm) Dimensions (mm) Abmessungen (mm)						Uç Insert WSP	Baskı Civatası Locking Screw Verriegelungs-Schraube	Altık Shim U-Platte	Altık Pimi Lock Pin Rohrstift	Baskı Kepi Clamp Spannpratze	Yay Spring Feder	Pul Washer U-Scheibe	Anahtar Allen Key Inbuss-Schlüssel
			L	L1	h	f	b	kg								
D108	●	MTENN 2020 K16	125	35	20	10	20	0,408	TN--1604	TC046 M5	TA019	BSP020	BK022	BY043	BSP031	3 Allen
D110	●	MTENN 2525 M16	150	35	25	12.5	25	0,724	TN--1604	TC046 M5	TA019	BSP020	BK022	BY043	BSP031	3 Allen
D112	●	MTENN 2525 M22	150	40	25	12.5	25	0,734	TN--2204	TC044 M6	TA045	BSP021	BK023	BY040	BSP030	3 Allen
D113	●	MTENN 3232 P22	170	40	32	16	32	1,311	TN--2204	TC044 M6	TA045	BSP021	BK023	BY040	BSP030	3 Allen

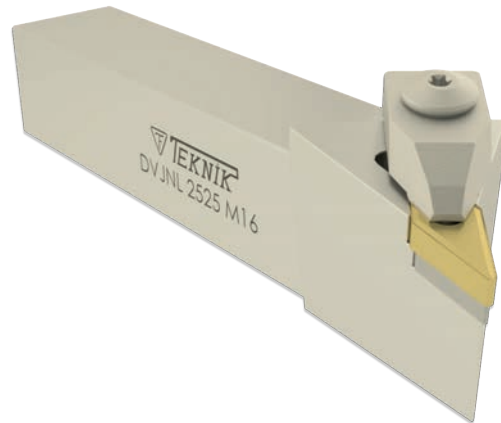
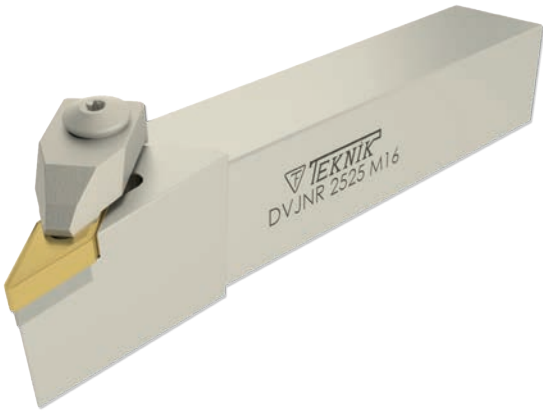

93° DVJNR

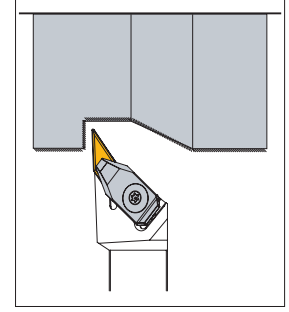
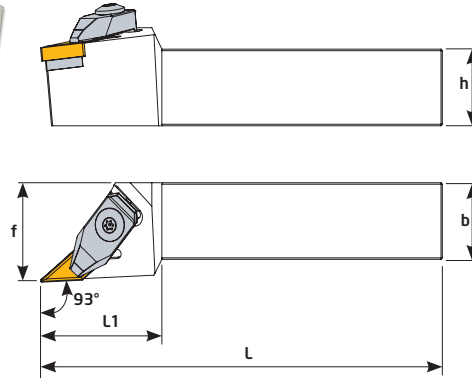

Sipariş Kodu Order Code Best.-Nr.	Stok/Stock/Lager	Ürün Kodu Product Code Produkt-Code	Ölçüler (mm) Dimensions (mm) Abmessungen (mm)							Uç Insert WSP	Baskı Civatası Locking Screw Verriegelungs Schraube	Altlık Shim U-Platte	Altlık Civatası Shim Screw U-Platte Schraube	Baskı Kepi Clamp Spann- pratze	Yay Spring Feder	Pul Washer U-Scheibe	Anahtar Allen Key Inbuss-Schlüssel
			L	L1	h	f	b	kg									
D105-1	●	DVJNR 2020 K16	125	40	20	27	20	0,428	VN-- 1604	TC046 M5	TA033	TC074 M4x10	BK021	BY043	BSP031	3 Allen	
D105	●	DVJNR 2525 M16	150	40	25	32	25	0,427									

93° DVJNL

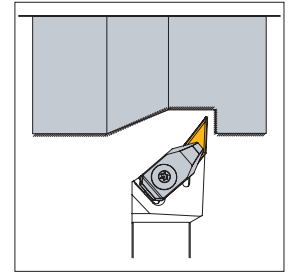
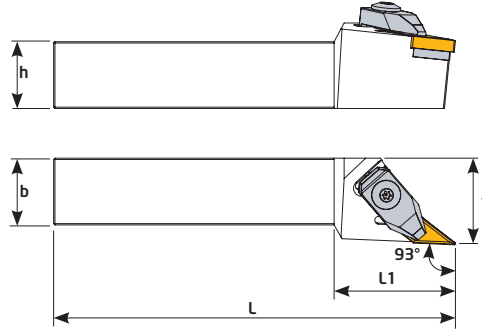
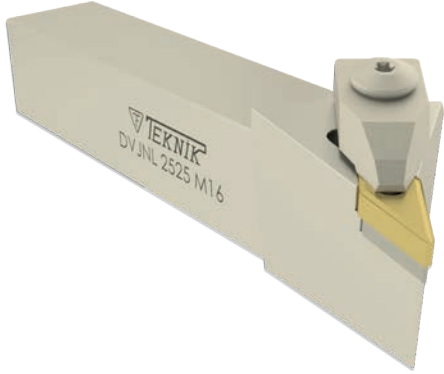

Sipariş Kodu Order Code Best.-Nr.	Stok/Stock/Lager	Ürün Kodu Product Code Produkt-Code	Ölçüler (mm) Dimensions (mm) Abmessungen (mm)							Uç Insert WSP	Baskı Civatası Locking Screw Verriegelungs Schraube	Altlık Shim U-Platte	Altlık Civatası Shim Screw U-Platte Schraube	Baskı Kepi Clamp Spann- pratze	Yay Spring Feder	Pul Washer U-Scheibe	Anahtar Allen Key Inbuss-Schlüssel
			L	L1	h	f	b	kg									
D343	●	DVJNL 2020 K16	125	40	20	27	20	0,428	VN-- 1604	TC046 M5	TA033	TC074 M4x10	BK021	BY043	BSP031	3 Allen	
D344	●	DVJNL 2525 M16	150	40	25	32	25	0,427									



72,5° DVVNN

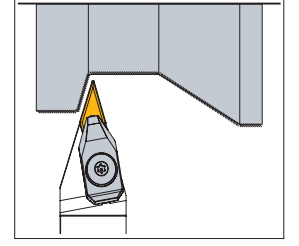
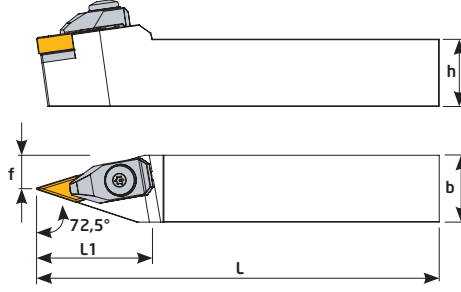

Sipariş Kodu Order Code Best.-Nr.	Stok/Stock/Lager	Ürün Kodu Product Code Produkt-Code	Ölçüler (mm) Dimensions(mm) Abmessungen (mm)						Uç Insert WSP	Baskı Cıvatası Locking Screw Verriegelungs Schraube	Altlık Shim U-Platte	Altlık Cıvatası Shim Screw U-Platte Schraube	Baskı Kepi Clamp Spann- pratze	Yay Spring Feder	Pul Washer U-Scheibe	Anahtar Allen Key Inbuss-Schlüssel
			L	L1	h	f	b	kg								
D105-2	●	DVVNN 2525 M16	150	45	25	12,5	25	0,690	VN-- 1604	TC046 M5	TA033	TC074 M4x10	BK021	BY043	BSP031	3 Allen

93° CKJNR

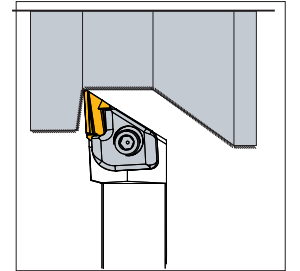
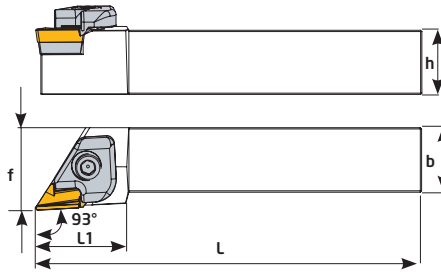

Sipariş Kodu Order Code Best.-Nr.	Stok/Stock/Lager	Ürün Kodu Product Code Produkt-Code	Ölçüler (mm) Dimensions(mm) Abmessungen (mm)						Uç Insert WSP	Baskı Cıvatası Locking Screw Verriegelungs Schraube	Altlık Shim U-Platte	Altlık Cıvatası Shim Screw U-Platte Schraube	Baskı Kepi Clamp Spann- pratze	Yay Spring Feder	Pul Washer U-Scheibe	Anahtar Allen Key Inbuss-Schlüssel
			L	L1	h	f	b	kg								
RD018	●	CKJNR 2020 K16	125	32	20	27	20	0,434	KNUX 1604	TC044 M6	TA046	TC036 M3x10	BK028	BY042	BSP030	3 Allen
RD014	●	CKJNR 2525 M16	150	35	25	30	25	0,753								
RD013	●	CKJNR 3232 P16	170	35	32	40	32	1,311								

TEKNIK

» ÇALIŞKAN »
« TEKNOLOJİ «

www.teknikcuttingtools.com



www.teknikcuttingtools.com

S Sistem Dış Çap Kater
S System External Turning Holder
S System Klemmhalter



**Technical Solution
for Quality**



95° SCLCR

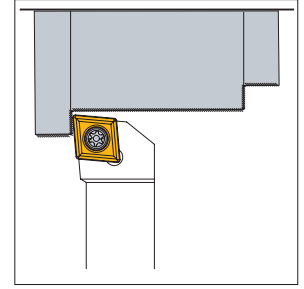
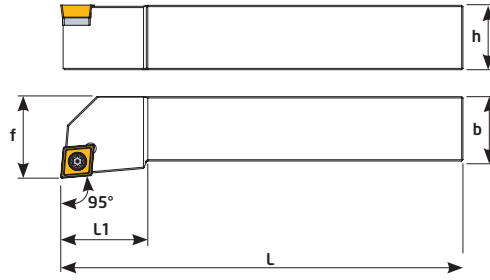

Sipariş Kodu Order Code Best.-Nr.	Stok/Stock/Lager	Ürün Kodu Product Code Produkt-Code	Ölçüler (mm) Dimensions(mm) Abmessungen (mm)						Uç Insert WSP	Sıkma Civatası Clamp Screw Torx-Schraube	Altlık Shim U-Platte	Altlık Civatası Shim Screw U-Platte Schraube	Anahtar Torx Key Torx-Schlüssel
			L	L1	h	f	b	ISO					
D398	●	SCLCR 1010 J06	110	10	10	12	10	0,105	CC-- 0602	TC060 M2,5x5,5	---	---	T8
D400	●	SCLCR 1212 J09	110	16	12	16	12	0,140	CC-- 09T3	TC067 M3,5x8,5	---	---	T15
D401	●	SCLCR 1616 H09	100	20	16	20	16	0,215		TC068 M3,5x11	TA015	TC048 M5	
D402	●	SCLCR 2020 K09	125	25	20	25	20	0,425			TA015-1	TC049-1 M6	
D403	●	SCLCR 2525 M09	150	25	25	32	25	0,772	CC-- 1204	TC075 M4x11	TA015-1	TC049-1 M6	
D418	●	SCLCR 2020 K12	125	25	20	25	20	0,421					
D403-1	●	SCLCR 2525 M12	150	25	25	32	25	0,768					

95° SCLCL

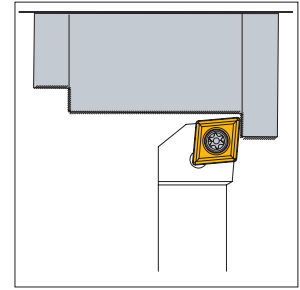
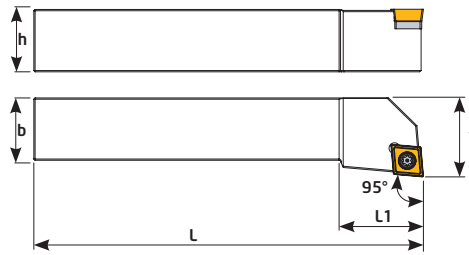
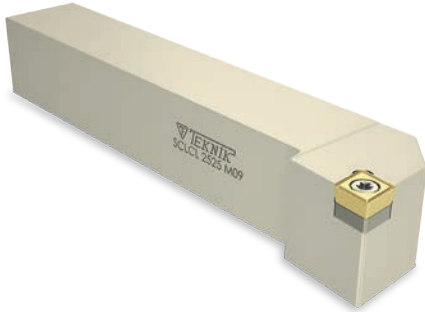

Sipariş Kodu Order Code Best.-Nr.	Stok/Stock/Lager	Ürün Kodu Product Code Produkt-Code	Ölçüler (mm) Dimensions(mm) Abmessungen (mm)						Kullanılan Uç Insert WSP	Sıkma Civatası Clamp Screw Torx-Schraube	Altlık Shim U-Platte	Altlık Ci- vatası Shim Screw U-Platte Schraube	Anahtar Torx Key Torx-Schlüssel
			L	L1	h	f	b	ISO					
D404	●	SCLCL 1010 J06	110	10	10	12	10	0,105	CC-- 0602	TC060 M2,5x5,5	---	---	T8
D405	●	SCLCL 1212 J09	110	16	12	16	12	0,140	CC-- 09T3	TC067 M3,5x8,5	---	---	T15
D406	●	SCLCL 1616 H09	100	20	16	20	16	0,215		TC068 M3,5x11	TA015	TC048 M5	
D407	●	SCLCL 2020 K09	125	25	20	25	20	0,425			TA015-1	TC049-1 M6	
D408	●	SCLCL 2525 M09	150	25	25	32	25	0,772	CC-- 1204	TC075 M4x11	TA015-1	TC049-1 M6	
D420	●	SCLCL 2020 K12	125	25	20	25	20	0,421					
D421	●	SCLCL 2525 M12	150	25	25	32	25	0,768					



90° SCACR-F

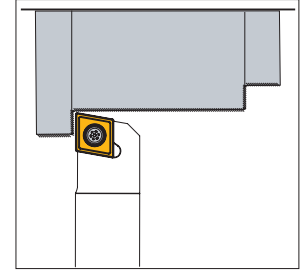
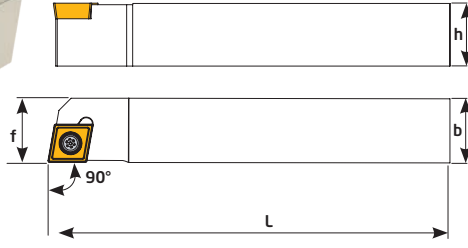

Sipariş Kodu Order Code Best.-Nr.	Stok/Stock/Lager	Ürün Kodu Product Code Produkt-Code	Ölçüler (mm) Dimensions(mm) Abmessungen (mm)					Kullanılan Uç Insert WSP	Altlık Shim U-Platte	Altlık Civatası Shim Screw U-Platte Schraube	Sıkma Civatası Clamp Screw Torx-Schraube	Anahtar Torx Key Torx-Schlüssel
			L	h	f	b	kg					
D411	●	SCACR 1010 J06-F	110	10	10	10	0,104	CCMT 0602	---	---	TC060 M2,5x5,5	T8
D412	●	SCACR 1212 J09-F	110	12	12	12	0,143	CCMT 09T3	---	---	TC067 M3,5x8,5	T15
D414	●	SCACR 1616 H09-F	100	16	16	16	0,221		TA015	TC048 M5	TC068 M3,5x11	
D416	●	SCACR 2020 K09-F	125	20	20	20	0,420					

95° SCLCR -F

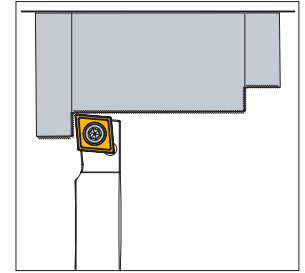
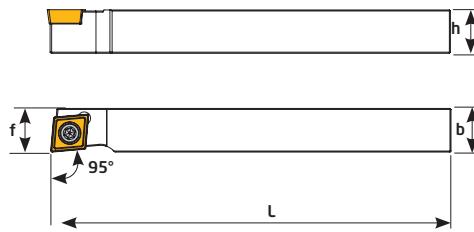

Sipariş Kodu Order Code Best.-Nr.	Stok/Stock/Lager	Ürün Kodu Product Code Produkt-Code	Ölçüler (mm) Dimensions(mm) Abmessungen (mm)					Kullanılan Uç Insert WSP	Altlık Shim U-Platte	Altlık Civatası Shim Screw U-Platte Schraube	Sıkma Civatası Clamp Screw Torx-Schraube	Anahtar Torx Key Torx-Schlüssel
			L	h	f	b	kg					
D422	●	SCLCR 1010 J06-F	110	10	10	10	0,106	CCMT 0602	---	---	TC060 M2,5x5,5	T8
D424	●	SCLCR 1212 J06-F	110	12	12	12	0,147					
D426	●	SCLCR 1212 J09-F	110	12	12	12	0,144	CCMT 09T3	TA015	TC048 M5	TC068 M3,5x11	T15
D428	●	SCLCR 1616 H09-F	100	16	16	16	0,224					
D430	●	SCLCR 2020 K09-F	125	20	20	20	0,426					

● Stokta/In Stock/Lager ○ Sınırlı Stok/Limited Stock/Begrenzte Lagerhaltung

Kalite için Teknik Çözüm | Technical Solution For Quality

BROTECH

TEKNIK
Cutting Tools

www.teknikcuttingtools.com

159

93° SDJCR

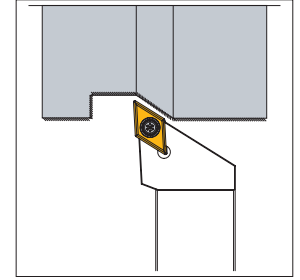
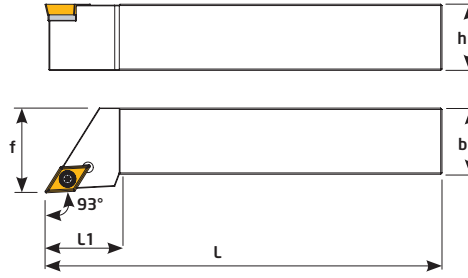

Sipariş Kodu Order Code Best.-Nr.	Stok/Stock/Lager	Ürün Kodu Product Code Produkt-Code	Ölçüler (mm) Dimensions(mm) Abmessungen (mm)						Kullanılan Uç Insert WSP	Sıkma Cıvatası Clamp Screw Torx-Schraube	Altlık Shim U-Platte	Altlık Cıvatası Shim Screw U-Platte Schraube	Anahtar Torx Key Torx-Schlüssel
			L	L1	h	f	b	kg					
D220	●	SDJCR 1010 J07	110	15	10	12	10	0,097	DCMT 0702	TC060 M2,5x5,5	---	---	T8
D220-1	●	SDJCR 1212 K07	125	15	12	16	12	0,132					
D221	●	SDJCR 1616 H07	100	18	16	20	16	0,204					
D221-1	●	SDJCR 2020 K07	125	20	20	25	20	0,404					
D222	●	SDJCR 1212 J11	110	20	12	16	12	0,132	DCMT 11T3	TC067 M3,5x8,5	---	---	T15
D224	●	SDJCR 1616 H11	100	25	16	20	16	0,204					
D226	●	SDJCR 2020 K11	125	25	20	25	20	0,404					
D228	●	SDJCR 2525 M11	150	30	25	32	25	0,735					

93° SDJCL

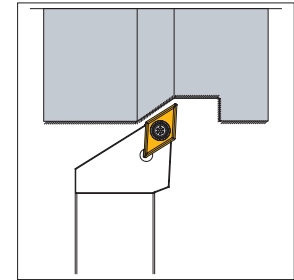
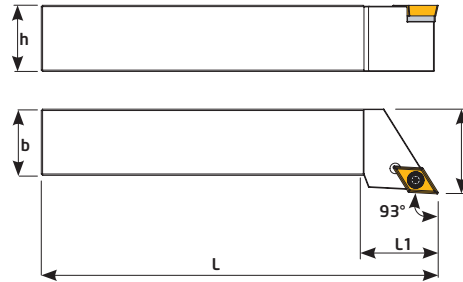

Sipariş Kodu Order Code Best.-Nr.	Stok/Stock/Lager	Ürün Kodu Product Code Produkt-Code	Ölçüler (mm) Dimensions(mm) Abmessungen (mm)						Kullanılan Uç Insert WSP	Sıkma Cıvatası Clamp Screw Torx-Schraube	Altlık Shim U-Platte	Altlık Cıvatası Shim Screw U-Platte Schraube	Anahtar Torx Key Torx-Schlüssel
			L	L1	h	f	b	kg					
D360	●	SDJCL 1010 J07	110	15	10	12	10	0,097	DCMT 0702	TC060 M2,5x5,5	---	---	T8
D360-1	●	SDJCL 1212 K07	125	15	12	16	12	0,132					
D361	●	SDJCL 1616 H07	100	18	16	20	16	0,204					
D361-1	●	SDJCL 2020 K07	125	20	20	25	20	0,404					
D362	●	SDJCL 1212 J11	110	20	12	16	12	0,132	DCMT 11T3	TC067 M3,5x8,5	---	---	T15
D364	●	SDJCL 1616 H11	100	25	16	20	16	0,204					
D366	●	SDJCL 2020 K11	125	25	20	25	20	0,404					
D368	●	SDJCL 2525 M11	150	30	25	32	25	0,735					



62,5° SDNCN

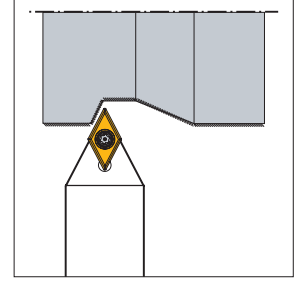
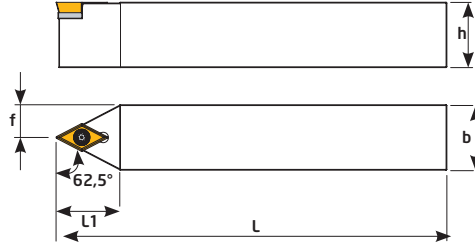

Sipariş Kodu Order Code Best.-Nr.	Stok/Stock/Lager	Ürün Kodu Product Code Produkt-Code	Ölçüler (mm) Dimensions(mm) Abmessungen (mm)						Kullanılan Uç Insert WSP	Sıkma Cıvatası Clamp Screw Torx-Schraube	Altlık Shim U-Platte	Altlık Cıvatası Shim Screw U-Platte Schraube	Anahtar Torx Key Torx-Schlüssel
			L	L1	h	f	b	kg					
D117	●	SDNCN 1010 J07	110	15	10	5	10	0,096	DC-- 0702	TC060 M2,5x5,5	---	---	T8
D118	●	SDNCN 1212 J11	110	25	12	6	12	0,131	DC-- 11T3	TC067 M3,5x8,5	---	---	T15
D120	●	SDNCN 1616 H11	100	25	16	8	16	0,196	DC-- 11T3	TC068 M3,5x11	TA030	TC048 M5	
D122	●	SDNCN 2020 K11	125	25	20	10	20	0,390					
D124	●	SDNCN 2525 M11	150	25	25	12,5	25	0,705					



90° SDACR-F

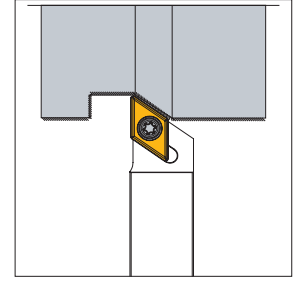
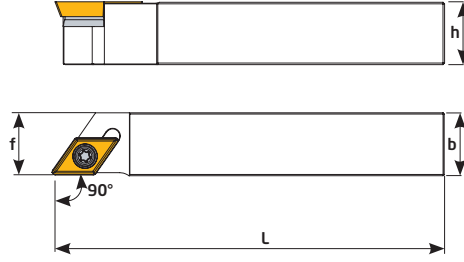

Sipariş Kodu Order Code Best.-Nr.	Stok/Stock/Lager	Ürün Kodu Product Code Produkt-Code	Ölçüler (mm) Dimensions(mm) Abmessungen (mm)					Kullanılan Uç Insert WSP	Sıkma Cıvatası Clamp Screw Torx-Schraube	Altlık Shim U-Platte	Altlık Cıvatası Shim Screw U-Platte Schraube	Anahtar Torx Key Torx-Schlüssel
			L	h	f	b	Ⓜ					
D434	●	SDACR 1010 J07-F	110	10	10	10	0,970	DCMT 0702	TC060 M2,5x5,5	---	---	T8
D436	●	SDACR 1212 J07-F	110	12	12	12	0,135					
D438	●	SDACR 1616 H07-F	100	16	16	16	0,207					
D440	●	SDACR 1212 J11-F	110	12	12	12	0,135	DCMT 11T3	TC067 M3,5x8,5	TA030	TC048 M5	T15
D442	●	SDACR 1616 H11-F	100	16	16	16	0,200					
D444	●	SDACR 2020 K11-F	125	20	20	20	0,397					

93° SDJCR-F

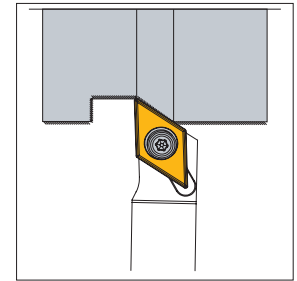
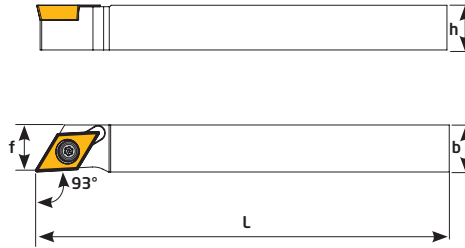

Sipariş Kodu Order Code Best.-Nr.	Stok/Stock/Lager	Ürün Kodu Product Code Produkt-Code	Ölçüler (mm) Dimensions(mm) Abmessungen (mm)					Kullanılan Uç Insert WSP	Sıkma Cıvatası Clamp Screw Torx-Schraube	Anahtar Torx Key Torx-Schlüssel
			L	h	f	b	Ⓜ			
D452	●	SDJCR 1010 J07-F	110	10	10	10	0,103	DCMT 0702	TC060 M2,5x5,5	T8
D454	●	SDJCR 1212 J07-F	110	12	12	12	0,131			
D456	●	SDJCR 1616 H07-F	100	16	16	16	0,192			
D457	●	SDJCR 1212 J11-F	110	12	12	12	0,134	DCMT 11T3	TC067 M3,5x8,5	T15



107,5° SDHCR

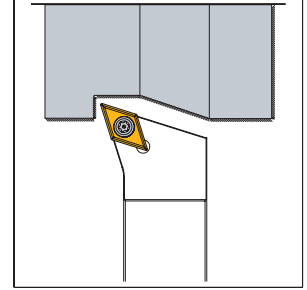
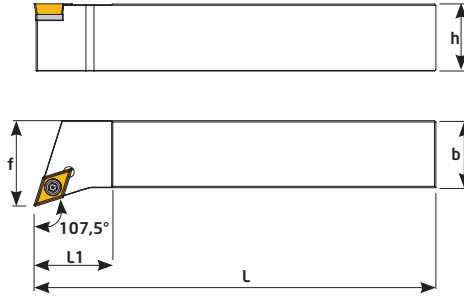

Sipariş Kodu Order Code Best.-Nr.	Stok/Stock/Lager	Ürün Kodu Product Code Produkt-Code	Ölçüler (mm) Dimensions(mm) Abmessungen (mm)						Kullanılan Uç Insert WSP	Sıkma Civatası Clamp Screw Torx-Schraube	Altık Shim U-Platte	Altık Civatası Shim Screw U-Platte Schraube	Anahtar Torx Key Torx-Schlüssel
			L	L1	h	f	b	kg					
D250	●	SDHCR 2020 K11	125	25	20	25	20	0,411	DCMT 11T3	TC068 M3,5x11	TA030	TC048 M5	T15
D252	●	SDHCR 2525 M11	150	25	25	32	25	0,738					

107,5° SDHCL

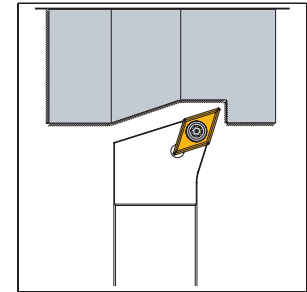
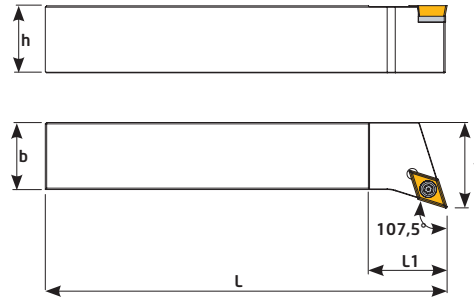
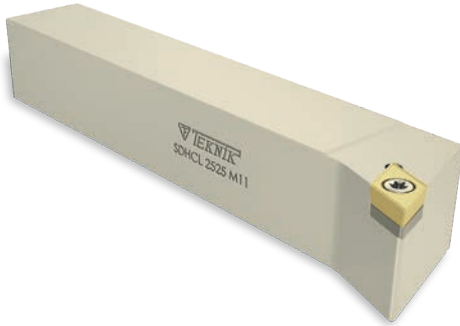

Sipariş Kodu Order Code Best.-Nr.	Stok/Stock/Lager	Ürün Kodu Product Code Produkt-Code	Ölçüler (mm) Dimensions(mm) Abmessungen (mm)						Kullanılan Uç Insert WSP	Sıkma Civatası Clamp Screw Torx-Schraube	Altık Shim U-Platte	Altık Civatası Shim Screw U-Platte Schraube	Anahtar Torx Key Torx-Schlüssel
			L	L1	h	f	b	kg					
D350	●	SDHCL 2020 K11	125	25	20	25	20	0,411	DCMT 11T3	TC068 M3,5x11	TA030	TC048 M5	T15
D352	●	SDHCL 2525 M11	150	25	25	32	25	0,738					

93° SVJBR

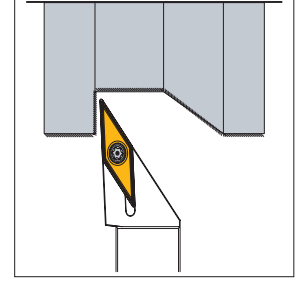
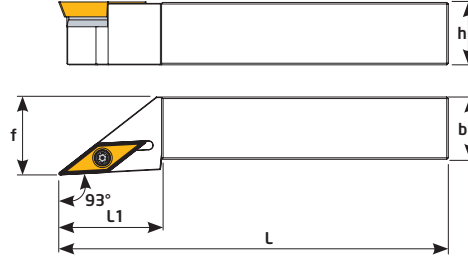

Sipariş Kodu Order Code Best.-Nr.	Stok/Stock/Lager	Ürün Kodu Product Code Produkt-Code	Ölçüler (mm) Dimensions(mm) Abmessungen (mm)							Kullanılan Uç Insert WSP	Sıkma Cıvatası Clamp Screw Torx-Schraube	Altlık Shim U-Platte	Altlık Cıvatası Shim Screw U-Platte Schraube	Anahtar Torx Key Torx-Schlüssel
			L	L1	h	f	b	Ⓢ						
D230	●	SVJBR 1010 J11	110	21	10	12	10	0,097	VBMT 1103	TC061 M2,5x6,5	---	---	T8	
D232	●	SVJBR 1212 J11	110	21	12	16	12	0,141						
D234	●	SVJBR 1616 H11	100	25	16	20	16	0,192						
D235	●	SVJBR 1616 H16	100	33	16	20	16	0,192	VBMT 1604	TC068 M3,5x11	TA034	TC048 M5	T15	
D236	●	SVJBR 2020 K16	125	33	20	25	20	0,382						
D238	●	SVJBR 2525 M16	150	40	25	32	25	0,688						
D238-1	●	SVJBR 3232 P16	170	40	32	40	32	1,370						

93° SVJBL

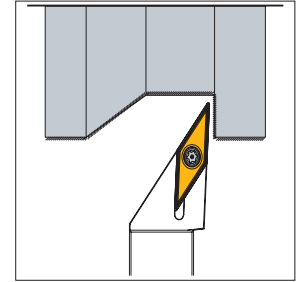
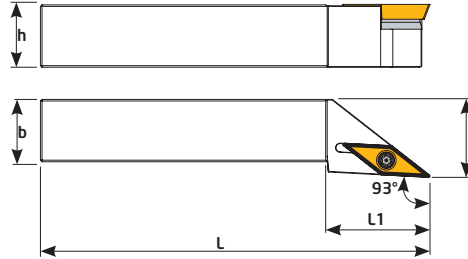
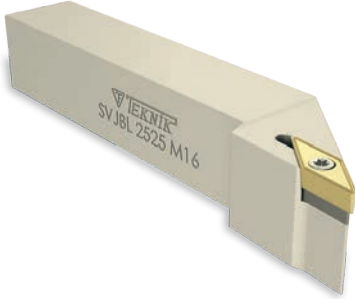

Sipariş Kodu Order Code Best.-Nr.	Stok/Stock/Lager	Ürün Kodu Product Code Produkt-Code	Ölçüler (mm) Dimensions(mm) Abmessungen (mm)							Kullanılan Uç Insert WSP	Sıkma Cıvatası Clamp Screw Torx-Schraube	Altlık Shim U-Platte	Altlık Cıvatası Shim Screw U-Platte Schraube	Anahtar Torx Key Torx-Schlüssel
			L	L1	h	f	b	Ⓢ						
D370	●	SVJBL 1010 J11	110	21	10	12	10	0,097	VBMT 1103	TC061 M2,5x6,5	---	---	T8	
D372	●	SVJBL 1212 J11	110	21	12	16	12	0,141						
D373	●	SVJBL 1616 H11	100	25	16	20	16	0,192						
D374	●	SVJBL 1616 H16	100	33	16	20	16	0,192	VBMT 1604	TC068 M3,5x11	TA034	TC048 M5	T15	
D380	●	SVJBL 2020 K16	125	33	20	25	20	0,382						
D382	●	SVJBL 2525 M16	150	40	25	32	25	0,688						
D382-1	●	SVJBL 3232 P16	170	40	32	40	32	1,370						

● Stokta/In Stock/Lager ○ Sınırlı Stok/Limited Stock/Begrenzte Lagerhaltung



72,5° SVVBN

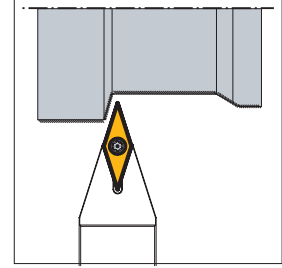
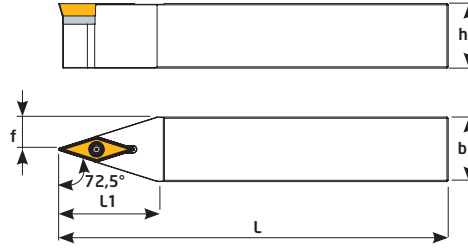

Sipariş Kodu Order Code Best.-Nr.	Stok/Stock/Lager	Ürün Kodu Product Code Produkt-Code	Ölçüler (mm) Dimensions (mm) Abmessungen (mm)						Kullanılan Uç Insert WSP	Sıkma Cıvatası Clamp Screw Torx-Schraube	Altlık Shim U-Platte	Altlık Cıvatası Shim Screw U-Platte Schraube	Anahtar Torx Key Torx-Schlüssel
			L	L1	h	f	b	ISO					
D131	●	SVVBN 1212 J11	110	25	12	6	12	0,129	VBMT 1103	TC061 M2,5x6,5	---	---	T8
D132	●	SVVBN 1616 H16	100	33	16	8	16	0,184	VBMT 1604	TC068 M3,5x11	TA034	TC048 M5	T15
D138	●	SVVBN 2020 K16	125	35	20	10	20	0,370					
D140	●	SVVBN 2525 M16	150	40	25	12,5	25	0,668					
D141	●	SVVBN 3232 P16	170	40	32	40	32	1,386					



● Stokta/In Stock/Lager ○ Sınırlı Stok/Limited Stock/Begrenzte Lagerhaltung

Kalite için Teknik Çözüm | Technical Solution For Quality

BROTECH

TEKNİK
Cutting Tools

www.teknikcuttingtools.com

165

107,5 SVHBR

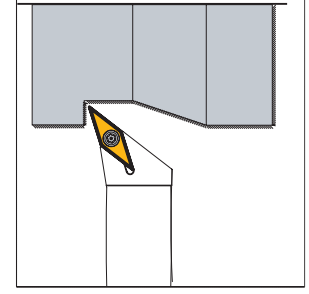
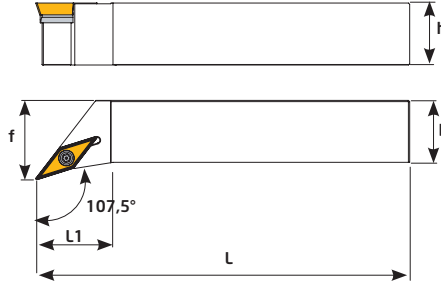

Sipariş Kodu Order Code Best.-Nr.	Stok/Stock/Lager	Ürün Kodu Product Code Produkt-Code	Ölçüler (mm) Dimensions(mm) Abmessungen (mm)						Kullanılan Uç Insert WSP	Sıkma Civatası Clamp Screw Torx-Schraube	Altlık Shim U-Platte	Altlık Civatası Shim Screw U-Platte Schraube	Anahtar Torx Key Torx-Schlüssel
			L	L1	h	f	b	kg					
D354-1	●	SVHBR 2020 K16	125	30	20	25	20	0,387	VBMT 1604	TC068 M3,5x11	TA034	TC048 M5	T15
D356-1	●	SVHBR 2525 M16	150	30	25	32	25	0,712					

107,5 SVHBL

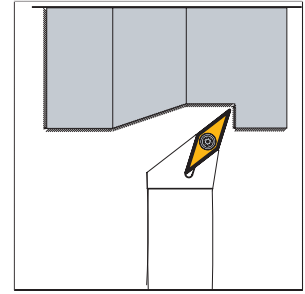
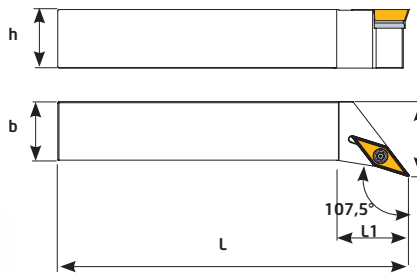

Sipariş Kodu Order Code Best.-Nr.	Stok/Stock/Lager	Ürün Kodu Product Code Produkt-Code	Ölçüler (mm) Dimensions(mm) Abmessungen (mm)						Kullanılan Uç Insert WSP	Sıkma Civatası Clamp Screw Torx-Schraube	Altlık Shim U-Platte	Altlık Civatası Shim Screw U-Platte Schraube	Anahtar Torx Key Torx-Schlüssel
			L	L1	h	f	b	kg					
D355	●	SVHBL 2020 K16	125	30	20	25	20	0,387	VBMT 1604	TC068 M3,5x11	TA034	TC048 M5	T15
D356-2	●	SVHBL 2525 M16	150	30	25	32	25	0,712					



93° SVJBR-F

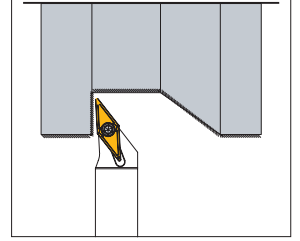
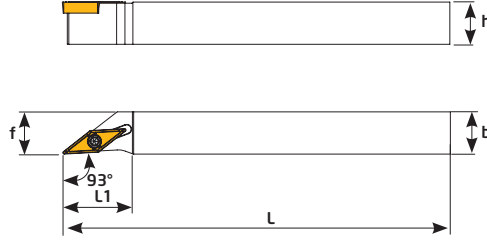
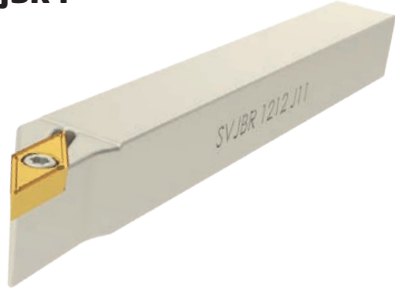

Sipariş Kodu Order Code Best.-Nr.	Stok/Stock/Lager	Ürün Kodu Product Code Produkt-Code	Ölçüler (mm) Dimensions(mm) Abmessungen (mm)					Kullanılan Uç Insert WSP	Sıkma Civatası Clamp Screw Torx-Schraube	Anahtar Torx Key Torx-Schlüssel	
			L	L1	h	f	b				KG
D128	●	SVJBR 1010 J11-F	110	22	10	10	10	VBMT 1103	TC061 M2,5x6,5	T8	
D129	●	SVJBR 1212 J11-F	110	22	12	12	12				0,132
D130	●	SVJBR 1616 H11-F	100	25	16	16	16				0,204

93° SVJBL-F

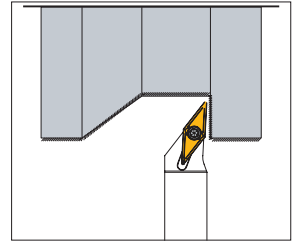
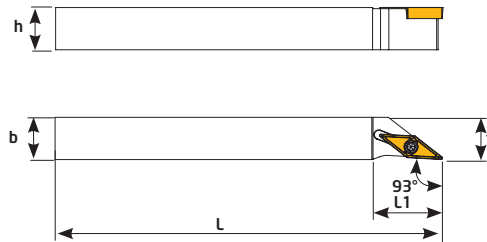

Sipariş Kodu Order Code Best.-Nr.	Stok/Stock/Lager	Ürün Kodu Product Code Produkt-Code	Ölçüler (mm) Dimensions(mm) Abmessungen (mm)					Kullanılan Uç Insert WSP	Sıkma Civatası Clamp Screw Torx-Schraube	Anahtar Torx Key Torx-Schlüssel	
			L	L1	h	f	b				KG
D395	●	SVJBL 1010 J11-F	110	22	10	10	10	VBMT 1103	TC061 M2,5x6,5	T8	
D396	●	SVJBL 1212 J11-F	110	22	12	12	12				0,132
D397	●	SVJBL 1616 H11-F	100	25	16	16	16				0,204

93° SVJCR

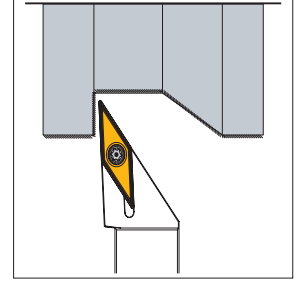
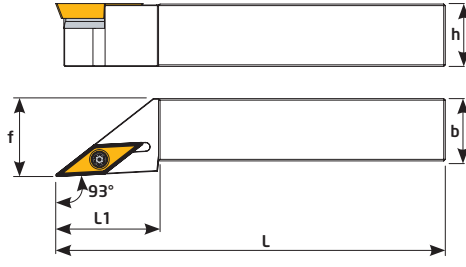

Sipariş Kodu Order Code Best.-Nr.	Stok/Stock/Lager	Ürün Kodu Product Code Produkt-Code	Ölçüler (mm) Dimensions(mm) Abmessungen (mm)							Uç Insert WSP	Sıkma Civatası Clamp Screw Torx-Schraube	Altlık Shim U-Platte	Altlık Civatası Shim Screw U-Platte Schraube	Anahtar Torx Key Torx-Schlüssel
			L	L1	h	f	b	kg						
D239	●	SVJCR 1010 J11	110	21	10	12	10	0,086	VCMT 1103	TC061 M2,5x6,5	---	---	T8	
D240	●	SVJCR 1212 J11	110	21	12	16	12	0,135						
D241	●	SVJCR 1616 H11	100	25	16	20	16	0,204						
D242	●	SVJCR 2020 K11	125	33	20	25	20	0,378						
D243	●	SVJCR 2525 M11	150	40	25	32	25	0,738						
D244	●	SVJCR 1616 H16	100	33	16	20	16	0,195	VCMT 1604	TC068 M3,5x11	TA034	TC048 M5	T15	
D246	●	SVJCR 2020 K16	125	33	20	25	20	0,385						
D248	●	SVJCR 2525 M16	150	40	25	32	25	0,683						
D249	●	SVJCR 3232 P16	170	50	32	40	32	1,284						

93° SVJCL

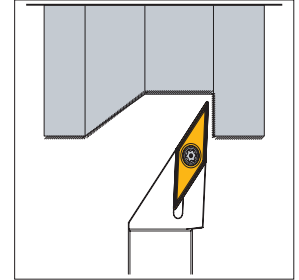
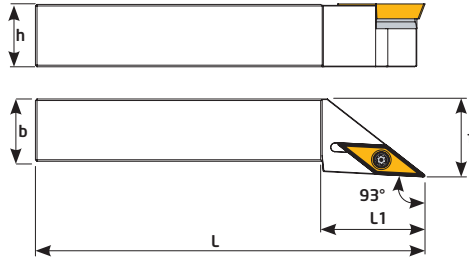
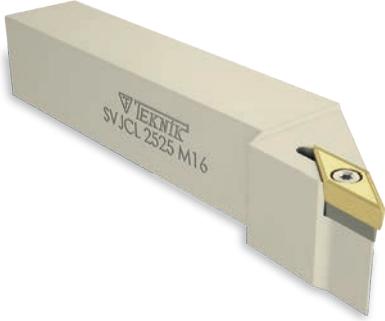

Sipariş Kodu Order Code Best.-Nr.	Stok/Stock/Lager	Ürün Kodu Product Code Produkt-Code	Ölçüler (mm) Dimensions(mm) Abmessungen (mm)							Uç Insert WSP	Sıkma Civatası Clamp Screw Torx-Schraube	Altlık Shim U-Platte	Altlık Civatası Shim Screw U-Platte Schraube	Anahtar Torx Key Torx-Schlüssel
			L	L1	h	f	b	kg						
D383	●	SVJCL 1010 J11	110	21	10	12	10	0,086	VCMT 1103	TC061 M2,5x6,5	---	---	T8	
D384	●	SVJCL 1212 J11	110	21	12	16	12	0,135						
D385	●	SVJCL 1616 H11	100	25	16	20	16	0,204						
D386	●	SVJCL 2020 K11	125	33	20	25	20	0,378						
D387	●	SVJCL 2525 M11	150	40	25	32	25	0,738						
D388	●	SVJCL 1616 H16	100	33	16	20	16	0,195	VCMT 1604	TC068 M3,5x11	TA034	TC048 M5	T15	
D390	●	SVJCL 2020 K16	125	33	20	25	20	0,385						
D392	●	SVJCL 2525 M16	150	40	25	32	25	0,683						
D393	●	SVJCL 3232 P16	170	50	32	40	32	1,284						



90° SVJCR-F

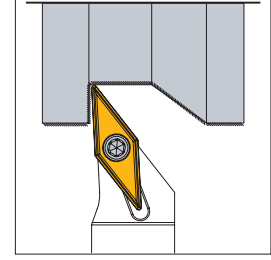
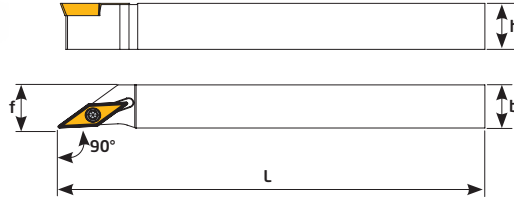

Sipariş Kodu Order Code Best.-Nr.	Stok/Stock/Lager	Ürün Kodu Product Code Produkt-Code	Ölçüler (mm) Dimensions(mm) Abmessungen (mm)					Kullanılan Uç Insert WSP	Sıkma Civatası Clamp Screw Torx-Schraube	Anahtar Torx Key Torx-Schlüssel
			L	h	f	b	kg			
D460	●	SVJCR 1212 J11-F	110	12	12	12	0,134	VCMT 1103	TC061 M2,5x6,5	T8
D462	●	SVJCR 1616 H11-F	100	16	16	16	0,202			

72,5° SVVCN

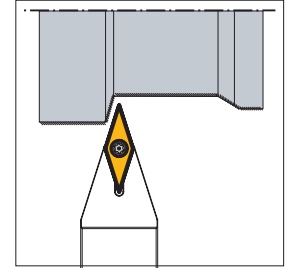
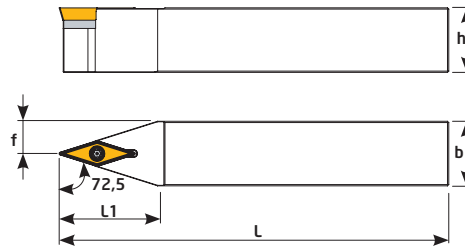
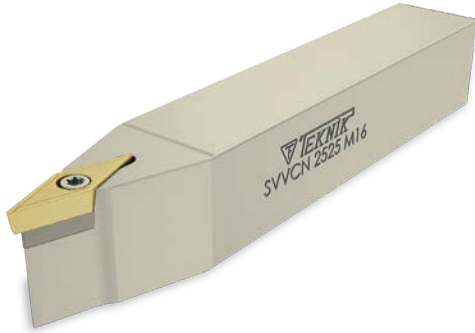

Sipariş Kodu Order Code Best.-Nr.	Stok/Stock/Lager	Ürün Kodu Product Code Produkt-Code	Ölçüler (mm) Dimensions(mm) Abmessungen (mm)						Kullanılan Uç Insert WSP	Sıkma Civatası Clamp Screw Torx-Schraube	Altlık Shim U-Platte	Altlık Ci- vatası Shim Screw U-Platte Schraube	Anahtar Torx Key Torx-Schlüssel
			L	L1	h	f	b	kg					
D142	●	SVVCN 1212 J11	110	22	12	6	12	0,127	VC--1103	TC061 M2,5x6,5	---	---	T8
D144	●	SVVCN 1616 H16	100	35	16	8	16	0,187	VCMT 1604	TC068 M3,5x11	TA034	TC048 M5	T15
D150	●	SVVCN 2020 K16	125	35	20	10	20	0,373					
D152	●	SVVCN 2525 M16	150	40	25	12,5	25	0,675					

107,5° SVHCR

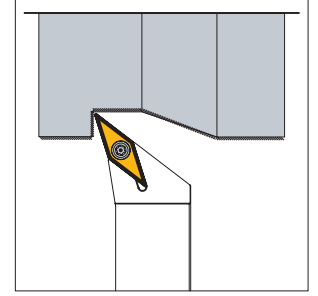
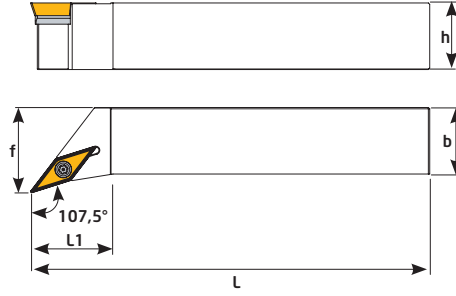

Sipariş Kodu Order Code Best.-Nr.	Stok/Stock/Lager	Ürün Kodu Product Code Produkt-Code	Ölçüler (mm) Dimensions(mm) Abmessungen (mm)						Kullanılan Uç Insert WSP	Sıkma Civatası Clamp Screw Torx-Schraube	Altlık Shim U-Platte	Altlık Civatası Shim Screw U-Platte Schraube	Anahtar Torx Key Torx-Schlüssel
			L	L1	h	f	b						
D254	●	SVHCR 2020 K16	125	30	20	25	20	0,384					
D256	●	SVHCR 2525 M16	150	30	25	32	25	0,707					

107,5° SVHCL

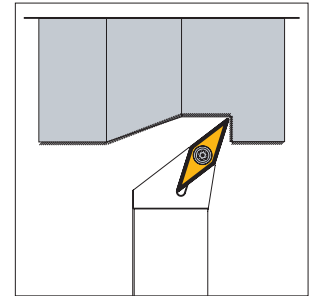
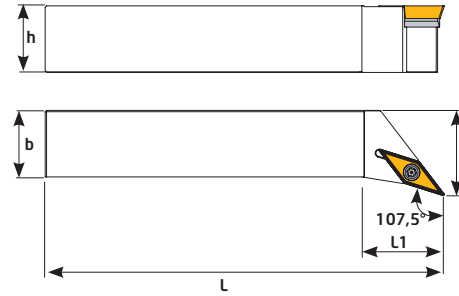

Sipariş Kodu Order Code Best.-Nr.	Stok/Stock/Lager	Ürün Kodu Product Code Produkt-Code	Ölçüler (mm) Dimensions(mm) Abmessungen (mm)						Kullanılan Uç Insert WSP	Sıkma Civatası Clamp Screw Torx-Schraube	Altlık Shim U-Platte	Altlık Civatası Shim Screw U-Platte Schraube	Anahtar Torx Key Torx-Schlüssel
			L	L1	h	f	b						
D354	●	SVHCL 2020 K16	125	30	20	25	20	0,384					
D356	●	SVHCL 2525 M16	150	30	25	32	25	0,707					



30° SRGCR

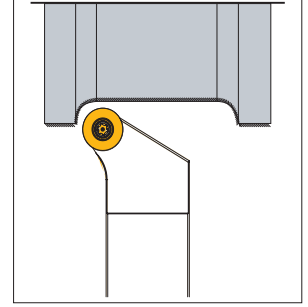
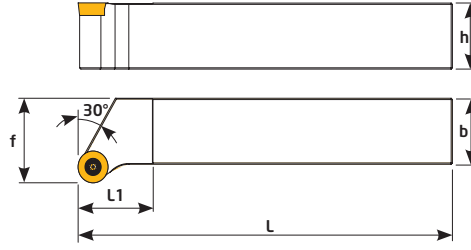

Sipariş Kodu Order Code Best.-Nr.	Stok/Stock/Lager	Ürün Kodu Product Code Produkt-Code	Ölçüler (mm) Dimensions(mm) Abmessungen (mm)						Kullanılan Uç Insert WSP	Sıkma Cıvatası Clamp Screw Torx-Schraube	Anahtar Torx Key Torx-Schlüssel
			L	L1	h	f	b	kg			
D280	●	SRGCR 2020 K08	125	25	20	25	20	0,411	RCMT 0803	TC065 M3x7	T8
D282	●	SRGCR 2525 M08	150	30	25	32	25	0,710			
D284	●	SRGCR 2020 K10	125	25	20	25	20	0,410	RCMT 10T3	TC067 M3,5x8,5	T15
D286	●	SRGCR 2525 M10	150	30	25	32	25	0,720			
D288	●	SRGCR 2020 K12	125	25	20	25	20	0,422	RCMT 12T3	TC067 M3,5x8,5	T15
D290	●	SRGCR 2525 M12	150	30	25	32	25	0,744			

30° SRGCL

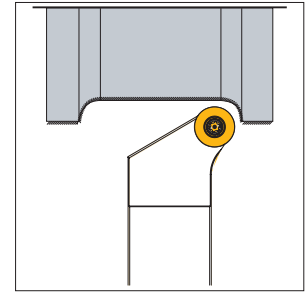
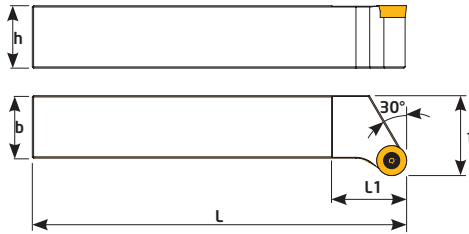

Sipariş Kodu Order Code Best.-Nr.	Stok/Stock/Lager	Ürün Kodu Product Code Produkt-Code	Ölçüler (mm) Dimensions(mm) Abmessungen (mm)						Kullanılan Uç Insert WSP	Sıkma Cıvatası Clamp Screw Torx-Schraube	Anahtar Torx Key Torx-Schlüssel
			L	L1	h	f	b	kg			
D293	●	SRGCL 2020 K08	125	25	20	25	20	0,411	RCMT 0803	TC065 M3x7	T8
D294	●	SRGCL 2525 M08	150	30	25	32	25	0,710			
D283	●	SRGCL 2020 K10	125	25	20	25	20	0,410	RCMT 10T3	TC067 M3,5x8,5	T15
D292	●	SRGCL 2525 M10	150	30	25	32	25	0,720			
D281	●	SRGCL 2020 K12	125	25	20	25	20	0,422	RCMT 12T3	TC067 M3,5x8,5	T15
D291	●	SRGCL 2525 M12	150	30	25	32	25	0,744			

SRDCN

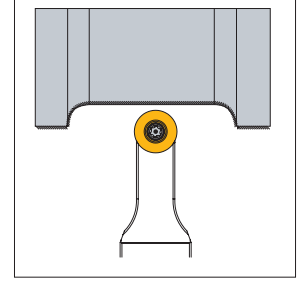
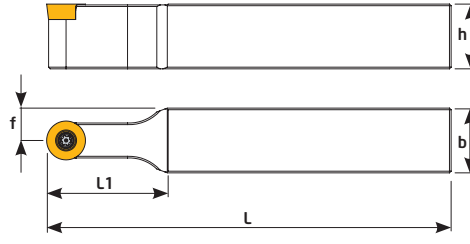
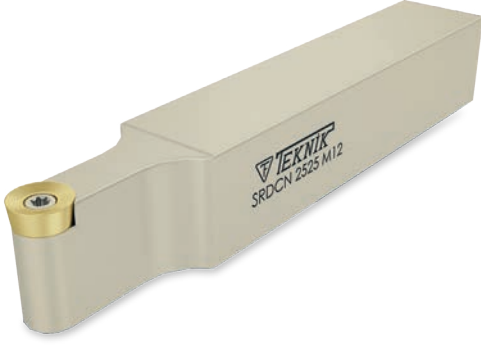

Sipariş Kodu Order Code Best.-Nr.	Stok/Stock/Lager	Ürün Kodu Product Code Produkt-Code	Ölçüler (mm) Dimensions(mm) Abmessungen (mm)						Kullanılan Uç Insert WSP	Sıkma Cıvatası Clamp Screw Torx-Schraube	Anahtar Torx Key Torx-Schlüssel
			L	L1	h	f	b	Ⓢ			
D270	●	SRDCN 2020 K08	125	37	20	10	20	0,358	RCMT 0803	TC065 M3x7	T8
D271	●	SRDCN 2525 M08	150	37	25	12.5	25	0,653			
D272	●	SRDCN 2020 K10	125	35	20	10	20	0,370	RCMT 10T3	TC067 M3,5x8,5	T15
D274	●	SRDCN 2525 M10	150	35	25	12.5	25	0,670			
D276	●	SRDCN 2020 K12	125	38	20	10	20	0,372	RCMT 1204	TC067 M3,5x8,5	T15
D278	●	SRDCN 2525 M12	150	38	25	12.5	25	0,668			
D273	●	SRDCN 2525 M16	150	35	25	12.5	25	0,701	RCMT 1606	TC083 M5x12	T20

TIRTIL Kater Knurling Tool

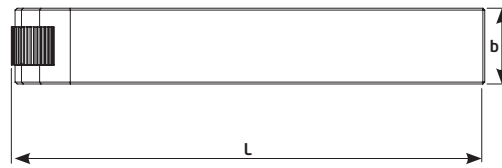
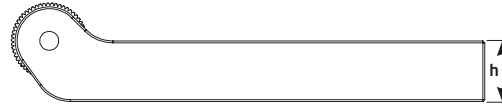

Sipariş Kodu Order Code Best.-Nr.	Stok/Stock/Lager	Ürün Kodu Product Code Produkt-Code	Ölçüler (mm) Dimensions(mm) Abmessungen (mm)					
			Ⓢ	L	h	b	Ⓢ	
P100	●	16-20 CNC TIRTIL	20x10x6	BSP041 6-23	125	16	20	0,351
P102	●	20-20 CNC TIRTIL	20x10x6	BSP041 6-18	125	20	20	0,427
P104	●	25-25 CNC TIRTIL	20x10x6	BSP040 6-23	150	25	25	0,600



AP Sistem İç Çap Kater - P Sistem İç Çap Kater
AP System / P System Boring Bars
AP System / P System Bohrstange



**Technical Solution
for Quality**



İçten Soğutmalı İç Çap Kater Boring Bars With Coolant

93° PDUNR IC

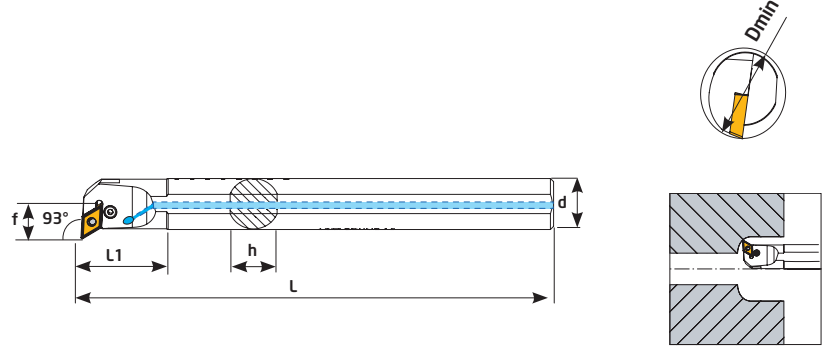

Sipariş Kodu Order Code Best.-Nr.	Stok/Stock/Lager	Ürün Kodu Product Code Produkt-Code	Ölçüler (mm) Dimensions(mm) Abmessungen (mm)							Kullanılan Uç Insert WSP	Sıkma Cıvatası Clamp Screw Klemm-Schraube	Altlık Shim U-Platte	Levye Sacı Lock Pin Rohrstift	Levye Lever Kniehebel	Anahtar Allen Key Inbuss-Schlüssel	
			Dmin	d	L	L1	f	h	ISO							
AP301	●	A20R PDUNR 11	25	20	200	40	13	18	0,500	DNMG 1104	TH512	---	---	TL3B	2 Allen	
AP300	●	A25S PDUNR 15	32	25	250	50	17	23	0,900		TH613	---	---	TL4A	2,5 Allen	
AP302	●	A32T PDUNR 15	40	32	300	55	22	30	1,770		DNMG 1506	TH822	TA014-1	TS-4	TL4B	3 Allen
AP304	●	A40T PDUNR 15	50	40	300	55	27	38	1,790							

93° PDUNR

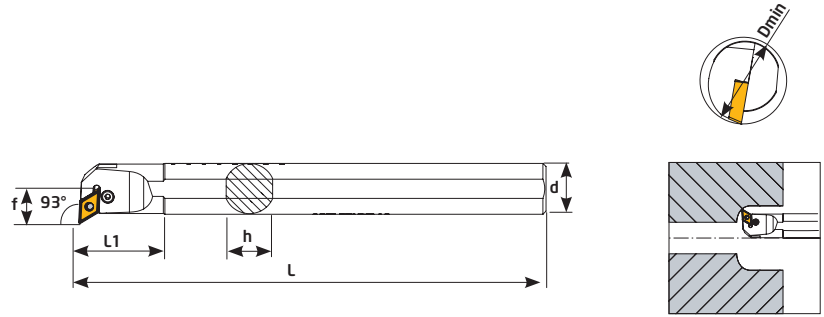
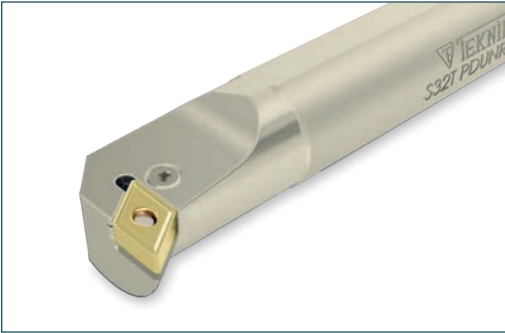

Sipariş Kodu Order Code Best.-Nr.	Stok/Stock/Lager	Ürün Kodu Product Code Produkt-Code	Ölçüler (mm) Dimensions(mm) Abmessungen (mm)							Kullanılan Uç Insert WSP	Sıkma Cıvatası Clamp Screw Klemm-Schraube	Altlık Shim U-Platte	Levye Sacı Lock Pin Rohrstift	Levye Lever Kniehebel	Anahtar Allen Key Inbuss-Schlüssel
			Dmin	d	L	L1	f	h	ISO						
P300	●	S25S PDUNR 15	32	25	250	50	17	23	0,930	DNMG 1506	TH613	---	---	TL4A	2,5 Allen
P302	●	S32T PDUNR 15	40	32	300	55	22	30	1,805		TH822	TA014-1	TS-4	TL4B	3 Allen
P304	●	S40T PDUNR 15	50	40	300	55	27	38	2,790						



İçten Soğutmalı İç Çap Kater Boring Bars With Coolant

93° PDUNL IC

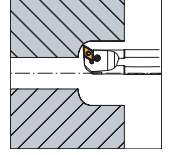
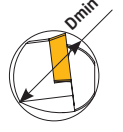
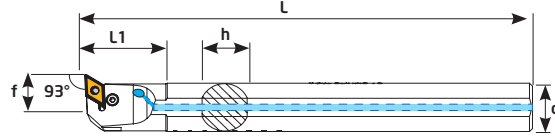
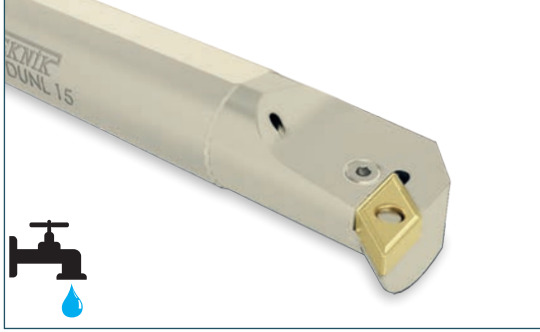

Sipariş Kodu Order Code Best.-Nr.	Stok/Stock/Lager	Ürün Kodu Product Code Produkt-Code	Ölçüler (mm) Dimensions(mm) Abmessungen (mm)							Kullanılan Uç Insert WSP	Sıkma Civatası Clamp Screw Klemm-Schraube	Altlık Shim U-Platte	Levye Sacı Lock Pin Rohrstift	Levye Lever Kniehebel	Anahtar Allen Key Inbuss-Schlüssel		
			Dmin	d	L	L1	f	h	ISO								
AP309	●	A20R PDUNL 11	25	20	200	40	13	18	0,500	DNMG 1104	TH512	---	---	TL3B	2 Allen		
AP310	●	A25S PDUNL 15	32	25	250	50	17	23	0,900			TH613	---	---	TL4A	2,5 Allen	
AP312	●	A32T PDUNL 15	40	32	300	55	22	30	1,770			DNMG 1506	TH822	TA014-1	TS-4	TL4B	3 Allen
AP314	●	A40T PDUNL 15	50	40	300	55	27	38	1,790								

93° PDUNL

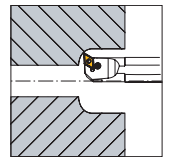
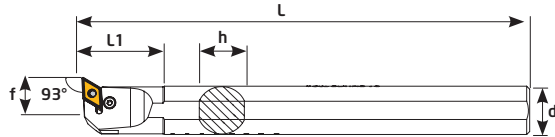
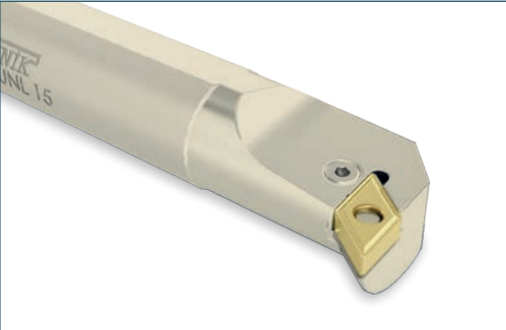

Sipariş Kodu Order Code Best.-Nr.	Stok/Stock/Lager	Ürün Kodu Product Code Produkt-Code	Ölçüler (mm) Dimensions(mm) Abmessungen (mm)							Kullanılan Uç Insert WSP	Sıkma Civatası Clamp Screw Klemm-Schraube	Altlık Shim U-Platte	Levye Sacı Lock Pin Rohrstift	Levye Lever Kniehebel	Anahtar Allen Key Inbuss-Schlüssel	
			Dmin	d	L	L1	f	h	ISO							
P310	●	S25S PDUNL 15	32	25	250	50	17	23	0,930	DNMG 1506	TH613	---	---	TL4A	2,5 Allen	
P312	●	S32T PDUNL 15	40	32	300	55	22	30	1,805			TH822	TA014-1	TS-4	TL4B	3 Allen
P314	●	S40T PDUNL 15	50	40	300	55	27	38	2,790							

İçten Soğutmalı İç Çap Kater Boring Bars With Coolant

95° PCLNR IC

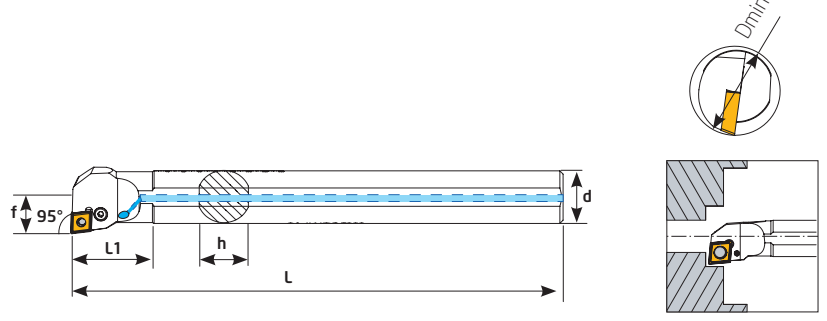

Sipariş Kodu Order Code Best.-Nr.	Stok/Stock/Lager	Ürün Kodu Product Code Produkt-Code	Ölçüler (mm) Dimensions(mm) Abmessungen (mm)						Kullanılan Uç Insert WSP	Sıkma Civatası Clamp Screw Klemm-Schraube	Altlık Shim U-Platte	Levye Sacı Lock Pin Rohrstift	Levye Lever Kniehebel	Anahtar Allen Key Inbuss-Schlüssel	
			Dmin	d	L	L1	f	h							kg
AP338	●	A20R PCLNR 12	24	20	200	50	13	18	0,520	CNMG 1204	TH613	---	---	TL4A	2,5 Allen
AP340	●	A25S PCLNR 12	32	25	250	50	17	23	0,921						
AP342	●	A32T PCLNR 12	40	32	300	50	22	30	1,809						
AP344	●	A40T PCLNR 12	50	40	300	55	27	38	1,820						

95° PCLNR

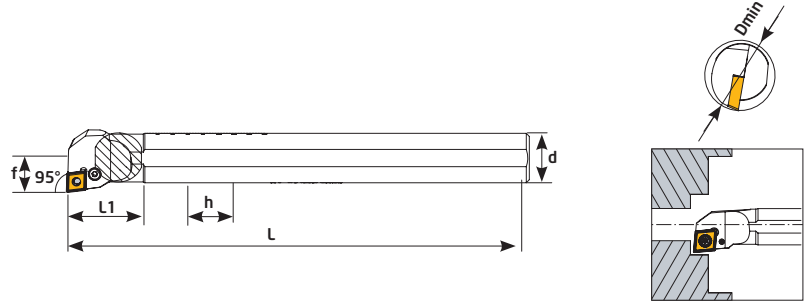

Sipariş Kodu Order Code Best.-Nr.	Stok/Stock/Lager	Ürün Kodu Product Code Produkt-Code	Ölçüler (mm) Dimensions(mm) Abmessungen (mm)						Kullanılan Uç Insert WSP	Sıkma Ci- vatası Clamp Screw Klemm- Schraube	Altlık Shim U-Platte	Levye Sacı Lock Pin Rohrstift	Levye Lever Kniehebel	Anahtar Allen Key Inbuss-Schlüssel	
			Dmin	d	L	L1	f	h							kg
P338	●	S20R PCLNR 12	24	20	200	50	13	18	0,540	CNMG 1204	TH613	---	---	TL4A	2,5 Allen
P340	●	S25S PCLNR 12	32	25	250	50	17	23	0,978						
P342	●	S32T PCLNR 12	40	32	300	50	22	30	1,815						
P344	●	S40T PCLNR 12	50	40	300	55	27	38	1,825						



İçten Soğutmalı İç Çap Kater Boring Bars With Coolant

95° PCLNL IC

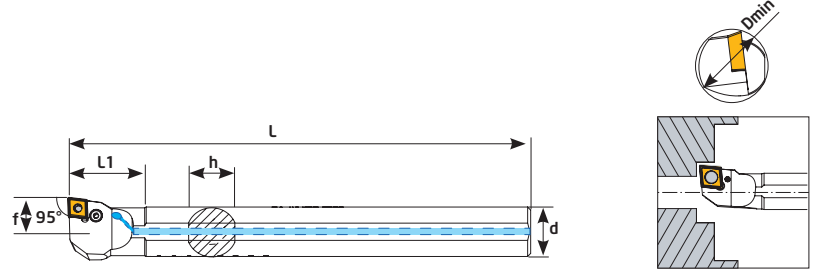

Sipariş Kodu Order Code Best.-Nr.	Stok/Stock/Lager	Ürün Kodu Product Code Produkt-Code	Ölçüler (mm) Dimensions(mm) Abmessungen (mm)							Kullanılan Uç Insert WSP	Sıkma Civatası Clamp Screw Klemm-Schraube	Altlık Shim U-Platte	Levye Sacı Lock Pin Rohrstift	Levye Lever Kniehebel	Anahtar Allen Key Inbuss-Schlüssel
			Dmin	d	L	L1	f	h	kg						
AP348	●	A20R PCLNR 12	24	20	200	50	13	18	0,520	CNMG 1204	TH613	---	---	TL4A	2,5 Allen
AP350	●	A25S PCLNL 12	32	25	250	50	17	23	0,921						
AP352	●	A32T PCLNL 12	40	32	300	50	22	30	1,809						
AP354	●	A40T PCLNL 12	50	40	300	55	27	38	1,820						

95° PCLNL

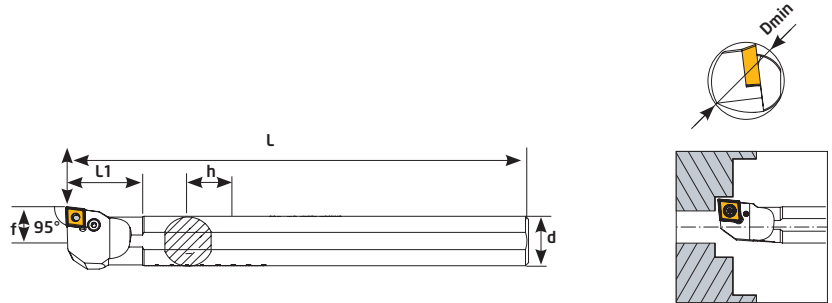

Sipariş Kodu Order Code Best.-Nr.	Stok/Stock/Lager	Ürün Kodu Product Code Produkt-Code	Ölçüler (mm) Dimensions(mm) Abmessungen (mm)							Kullanılan Uç Insert WSP	Sıkma Civatası Clamp Screw Klemm-Schraube	Altlık Shim U-Platte	Levye Sacı Lock Pin Rohrstift	Levye Lever Kniehebel	Anahtar Allen Key Inbuss-Schlüssel
			Dmin	d	L	L1	f	h	kg						
P348	●	S20R PCLNL 12	24	20	200	50	13	18	0,540	CNMG 1204	TH613	---	---	TL4A	2,5 Allen
P350	●	S25S PCLNL 12	32	25	250	50	17	23	0,978						
P352	●	S32T PCLNL 12	40	32	300	50	22	30	1,815						
P354	●	S40T PCLNL 12	50	40	300	55	27	38	1,825						

● Stokta/In Stock/Lager ○ Sınırlı Stok/Limited Stock/Begrenzte Lagerhaltung

Kalite için Teknik Çözüm | Technical Solution For Quality



www.teknikcuttingtools.com

İçten Soğutmalı İç Çap Kater Boring Bars With Coolant

95° PWLNR 08 IC

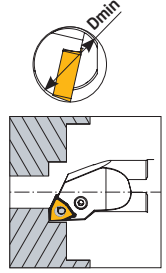
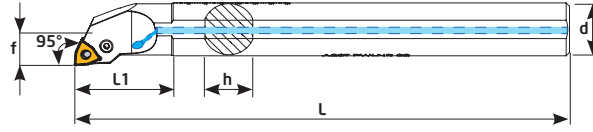

Sipariş Kodu Order Code Best.-Nr.	Stok/Stock/Lager	Ürün Kodu Product Code Produkt-Code	Ölçüler (mm) Dimensions(mm) Abmessungen (mm)							Uç Insert WSP	Sıkma Cıvatası Clamp Screw Klemm-Schraube	Altlık Shim U-Platte	Levyé Sacı Lock Pin Rohrstift	Levyé Lever Kniehebel	Anahtar Allen Key Inbuss-Schlüssel
			Dmin	d	L	L1	f	h	kg						
AP360	●	A25S PWLNR 08	32	25	250	50	17	23	0,911	WNMG 0804	TH613	---	---	TL4A	2,5 Allen
AP362	●	A32T PWLNR 08	40	32	300	60	22	30	1,764		TH821	TA020-1	TS-4	TL4	3 Allen
AP364	●	A40T PWLNR 08	50	40	300	60	27	38	2,800						

95° PWLNR 08

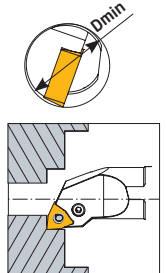
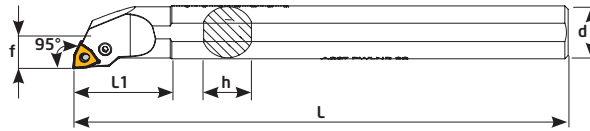
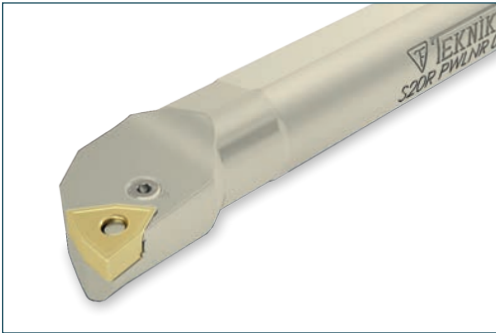

Sipariş Kodu Order Code Best.-Nr.	Stok/Stock/Lager	Ürün Kodu Product Code Produkt-Code	Ölçüler (mm) Dimensions(mm) Abmessungen (mm)							Uç Insert WSP	Sıkma Cıvatası Clamp Screw Klemm-Schraube	Altlık Shim U-Platte	Levyé Sacı Lock Pin Rohrstift	Levyé Lever Kniehebel	Anahtar Allen Key Inbuss-Schlüssel
			Dmin	d	L	L1	f	h	kg						
P360	●	S25S PWLNR 08	32	25	250	50	17	23	0,911	WNMG 0804	TH613	---	---	TL4A	2,5 Allen
P362	●	S32T PWLNR 08	40	32	300	60	22	30	1,764		TH821	TA020-1	TS-4	TL4	3 Allen
P364	●	S40T PWLNR 08	50	40	300	60	27	38	2,450						



İçten Soğutmalı İç Çap Kater Boring Bars With Coolant

95° PWLNL 08 IC

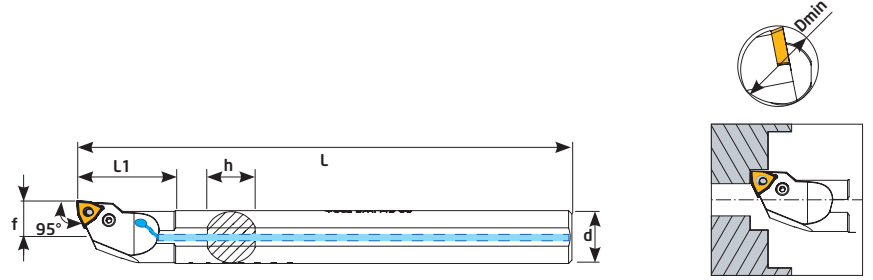
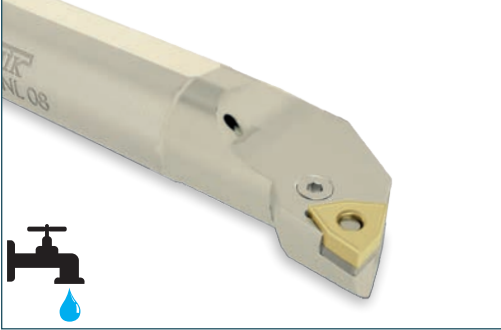

Sipariş Kodu Order Code Best.-Nr.	Stok/Stock/Lager	Ürün Kodu Product Code Produkt-Code	Ölçüler (mm) Dimensions(mm) Abmessungen (mm)							Uç Insert WSP	Sıkma Cıvatası Clamp Screw Klemm-Schraube	Altlık Shim U-Platte	Levye Sacı Lock Pin Rohrstift	Levye Lever Kniehebel	Anahtar Allen Key Inbuss-Schlüssel
			Dmin	d	L	L1	f	h	kg						
AP370	●	A25S PWLNL 08	32	25	250	50	17	23	0,911	WNMG 0804	TH613	---	---	TL4A	2,5 Allen
AP372	●	A32T PWLNL 08	40	32	300	60	22	30	1,764		TH821	TA020-1	TS-4	TL4	3 Allen
AP374	●	A40T PWLNL 08	50	40	300	60	27	38	2,800						

95° PWLNL 08

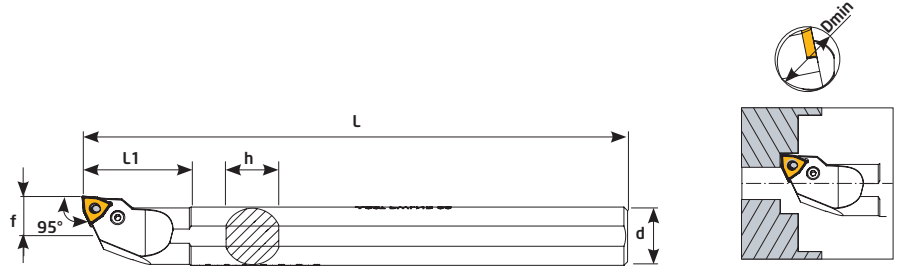
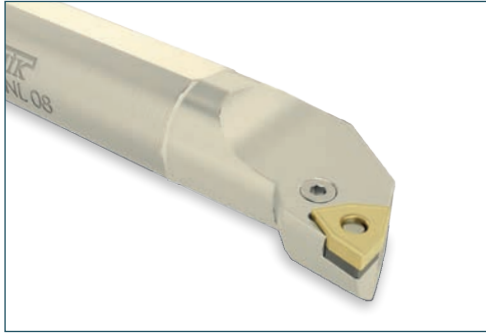

Sipariş Kodu Order Code Best.-Nr.	Stok/Stock/Lager	Ürün Kodu Product Code Produkt-Code	Ölçüler (mm) Dimensions(mm) Abmessungen (mm)							Uç Insert WSP	Sıkma Cıvatası Clamp Screw Klemm-Schraube	Altlık Shim U-Platte	Levye Sacı Lock Pin Rohrstift	Levye Lever Kniehebel	Anahtar Allen Key Inbuss-Schlüssel
			Dmin	d	L	L1	f	h	kg						
P370	●	S25S PWLNL 08	32	25	250	50	17	23	0,911	WNMG 0804	TH613	---	---	TL4A	2,5 Allen
P372	●	S32T PWLNL 08	40	32	300	60	22	30	1,764		TH821	TA020-1	TS-4	TL4	3 Allen
P374	●	S40T PWLNL 08	50	40	300	60	27	38	2,450						

İçten Soğutmalı İç Çap Kater Boring Bars With Coolant

95° PWLNR 06 IC

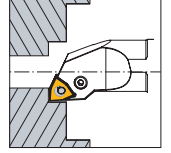
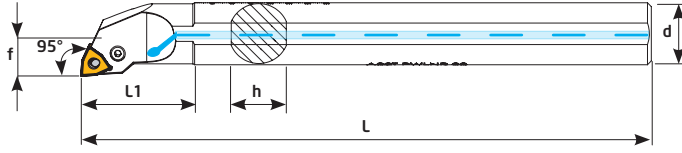

Sipariş Kodu Order Code Best.-Nr.	Stok/Stock/Lager	Ürün Kodu Product Code Produkt-Code	Ölçüler (mm) Dimensions(mm) Abmessungen (mm)							Kullanılan Uç Insert WSP	Sıkma Civatası Clamp Screw Klemm-Schraube	Levye Lever Kniehebel	Anahtar Allen Key Inbuss-Schlüssel
			Dmin	d	L	L1	f	h	Ⓢ				
AP380	●	A16R PWLNR 06	20	16	200	40	11	15	0,326	WNMG 0604	TH512	TL3B	2 Allen
AP382	●	A20R PWLNR 06	25	20	200	40	13	18	0,471				

95° PWLNR 06

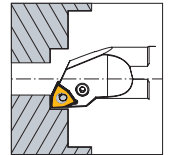
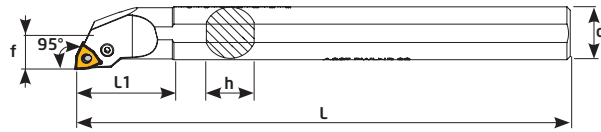
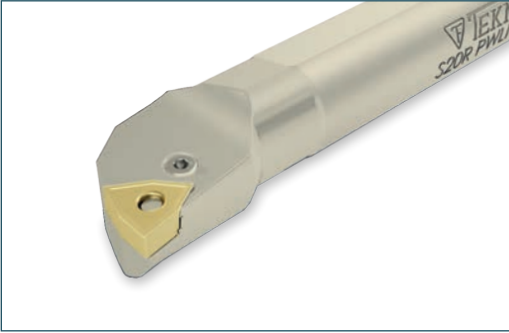

Sipariş Kodu Order Code Best.-Nr.	Stok/Stock/Lager	Ürün Kodu Product Code Produkt-Code	Ölçüler (mm) Dimensions(mm) Abmessungen (mm)							Kullanılan Uç Insert WSP	Sıkma Civatası Clamp Screw Klemm-Schraube	Levye Lever Kniehebel	Anahtar Allen Key Inbuss-Schlüssel
			Dmin	d	L	L1	f	h	Ⓢ				
P380	●	S16R PWLNR 06	20	16	200	40	11	15	0,316	WNMG 0604	TH512	TL3B	2 Allen
P382	●	S20R PWLNR 06	25	20	200	40	13	18	0,502				



İçten Soğutmalı İç Çap Kater Boring Bars With Coolant

95° PWLNL 06 IC

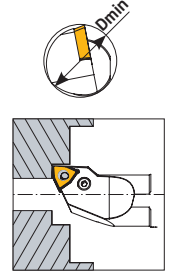
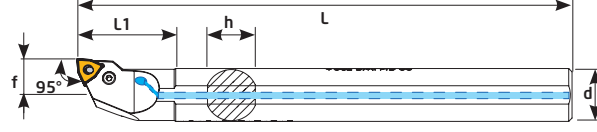

Sipariş Kodu Order Code Best.-Nr.	Stok/Stock/Lager	Ürün Kodu Product Code Produkt-Code	Ölçüler (mm) Dimensions(mm) Abmessungen (mm)							Kullanılan Uç Insert WSP	Sıkma Civatası Clamp Screw Klemm-Schraube	Levye Lever Kniehebel	Anahtar Allen Key Inbuss-Schlüssel
			Dmin	d	L	L1	f	h	☺				
AP388	●	A16R PWLNL 06	20	16	200	40	11	15	0,326	WNMG 0604	TH512	TL3B	2 Allen
AP390	●	A20R PWLNL 06	25	20	200	40	13	18	0,471				

95° PWLNL 06

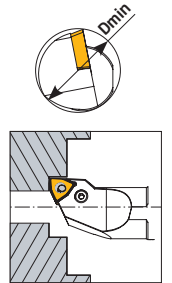
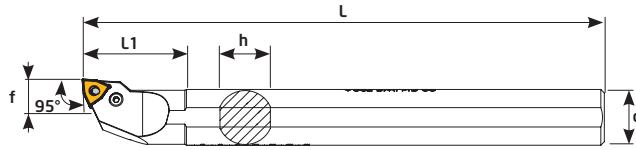
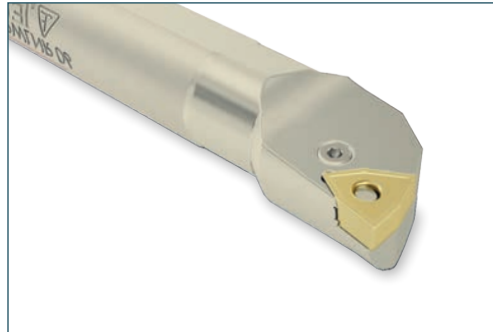

Sipariş Kodu Order Code Best.-Nr.	Stok/Stock/Lager	Ürün Kodu Product Code Produkt-Code	Ölçüler (mm) Dimensions(mm) Abmessungen (mm)							Kullanılan Uç Insert WSP	Sıkma Civatası Clamp Screw Klemm-Schraube	Levye Lever Kniehebel	Anahtar Allen Key Inbuss-Schlüssel
			Dmin	d	L	L1	f	h	☺				
P388	●	S16R PWLNL 06	20	16	200	40	11	15	0,316	WNMG 0604	TH512	TL3B	2 Allen
P390	●	S20R PWLNL 06	25	20	200	40	13	18	0,502				



D-M Sistem İç Çap Kater
D-M System Boring Bars
D-M System Bohrstange



**Technical Solution
for Quality**



93° DDUNR

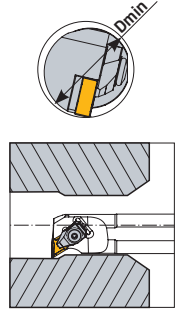
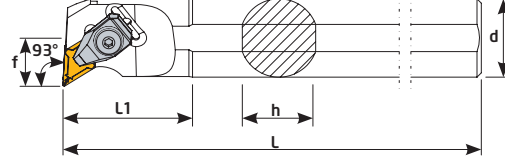
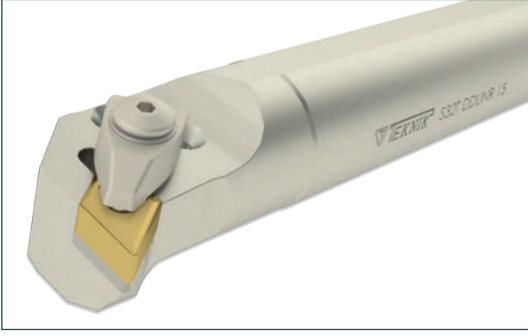

Sipariş Kodu Order Code Best.-Nr.	Stok/Stock/Lager	Ürün Kodu Product Code Produkt-Code	Ölçüler (mm) Dimensions(mm) Abmessungen (mm)							Uç Insert WSP	Baskı Cıvatası Locking Screw Verriegelungs Schraube	Altlık Shim U-Platte	Altlık Cıvatası Shim Screw U-Platte Schraube	Baskı Kepi Clamp Spann- pratze	Yay Spring Feder	Pul Washer U-Scheibe	Anahtar Allen Key Inbuss-Schlüssel
			Dmin	d	L	L1	f	h	kg								
K408	●	S20R DDUNR 11	30	20	200	50	13	18	0,508	DN--1104	TC046 M5	TA013	TC034 M3x7	BK024	BY041	BSP031	3 Allen
K409	●	S25S DDUNR 11	32	25	250	50	17	23	0,956								
K410	●	S25S DDUNR 15	32	25	250	50	17	23	0,950								
K412	●	S32T DDUNR 15	40	32	300	55	22	30	1,835								
K414	●	S40T DDUNR 15	50	40	300	60	27	38	2,848	DN--1506	TC044 M6	TA014-1	TC038 M4x10	BK020	BY040	BSP030	3 Allen
K415	●	S40U DDUNR 15	50	40	350	60	27	38	3,336								
K416	●	S50U DDUNR 15	63	50	350	65	35	47	5,153								
K417	●	S50X DDUNR 15	63	50	550	65	35	47	8,716								
K417-1	●	S60X DDUNR 15	73	60	600	65	37,5	57	13,66								
K411	●	S25S DDUNR 15	32	25	250	50	17	23	0,958	DN--1504	TC044 M6	TA014-1	TC038 M4x10	BK020	BY040	BSP030	3 Allen
K413	●	S32T DDUNR 15	40	32	300	55	22	30	1,830								

93° DDUNL

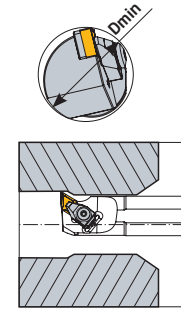
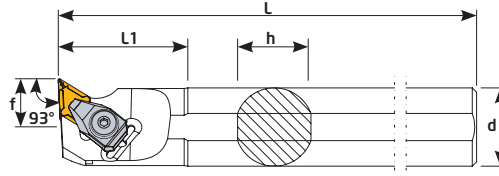
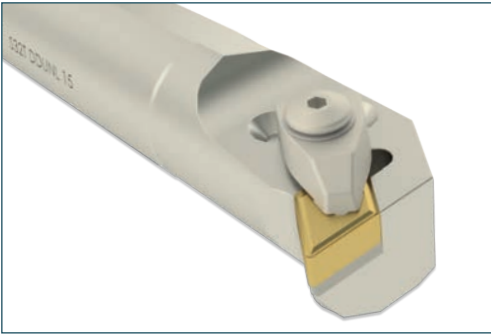

Sipariş Kodu Order Code Best.-Nr.	Stok/Stock/Lager	Ürün Kodu Product Code Produkt-Code	Ölçüler (mm) Dimensions(mm) Abmessungen (mm)							Uç Insert WSP	Baskı Cıvatası Locking Screw Verriegelungs Schraube	Altlık Shim U-Platte	Altlık Cıvatası Shim Screw U-Platte Schraube	Baskı Kepi Clamp Spann- pratze	Yay Spring Feder	Pul Washer U-Scheibe	Anahtar Allen Key Inbuss-Schlüssel
			Dmin	d	L	L1	f	h	kg								
K487	●	S20R DDUNL 11	30	20	200	50	13	18	0,508	DN--1104	TC046 M5	TA013	TC034 M3x7	BK024	BY041	BSP031	3 Allen
K488	●	S25S DDUNL 11	32	25	250	50	17	23	0,956								
K490	●	S25S DDUNL 15	32	25	250	50	17	23	0,950	DN--1506	TC044 M6	TA014-1	TC038 M4x10	BK020	BY040	BSP030	3 Allen
K492	●	S32T DDUNL 15	40	32	300	55	22	30	1,835								
K494	●	S40T DDUNL 15	50	40	300	60	27	38	2,848								
K495	●	S40U DDUNL 15	50	40	350	60	27	38	3,336								
K496	●	S50U DDUNL 15	63	50	350	65	35	47	5,153								



107,5° DDQNR

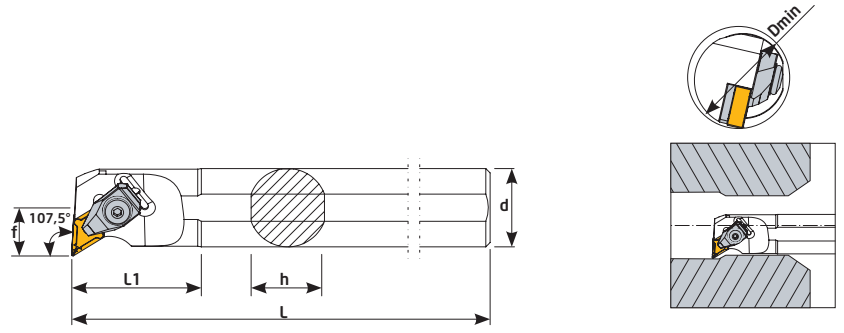
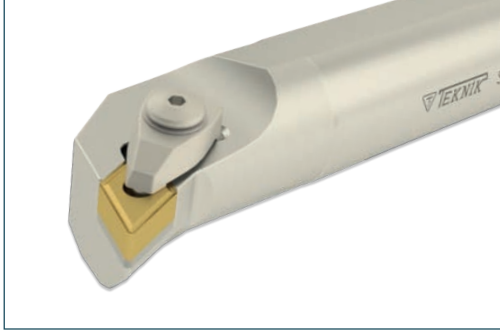

Sipariş Kodu Order Code Best.-Nr.	Stok/Stock/Lager	Ürün Kodu Product Code Produkt-Code	Ölçüler (mm) Dimensions(mm) Abmessungen (mm)							Uç Insert WSP	Baskı Civatası Locking Screw Verriegelungs Schraube	Altlık Shim U-Platte	Altlık Civatası Shim Screw U-Platte Schraube	Baskı Kepi Clamp Spann pratze	Yay Spring Feder	Pul Washer U-Scheibe	Anahtar Allen Key Inbuss-Schlüssel
			Dmin	d	L	L1	f	h	kg								
K476	●	S25S DDQNR 15	32	25	250	50	17	23	0,935	DN-- 1506	TC044 M6	TA014-1	TC038 M4x10	BK020	BY040	BSP030	3 Allen
K477	●	S32T DDQNR 15	40	32	300	60	22	30	1,805								
K478	●	S40T DDQNR 15	50	40	300	60	27	38	2,786								
K479	●	S50U DDQNR 15	63	50	350	65	35	47	5,166								

107,5° DDQNL

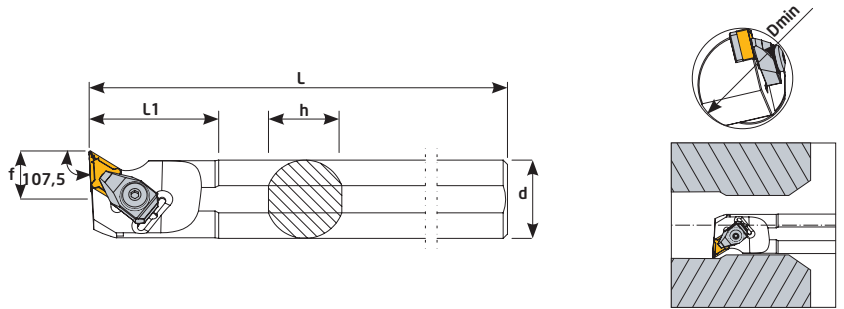
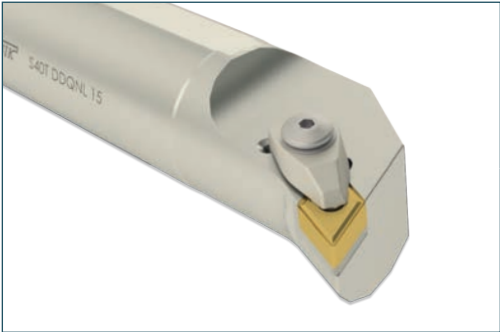

Sipariş Kodu Order Code Best.-Nr.	Stok/Stock/Lager	Ürün Kodu Product Code Produkt-Code	Ölçüler (mm) Dimensions(mm) Abmessungen (mm)							Uç Insert WSP	Baskı Civatası Locking Screw Verriegelungs Schraube	Altlık Shim U-Platte	Altlık Civatası Shim Screw U-Platte Schraube	Baskı Kepi Clamp Spann pratze	Yay Spring Feder	Pul Washer U-Scheibe	Anahtar Allen Key Inbuss-Schlüssel
			Dmin	d	L	L1	f	h	kg								
K533	●	S25S DDQNL 15	32	25	250	50	17	23	0,935	DN-- 1506	TC044 M6	TA014-1	TC038 M4x10	BK020	BY040	BSP030	3 Allen
K534	●	S32T DDQNL 15	40	32	300	60	22	30	1,805								
K535	●	S40T DDQNL 15	50	40	300	60	27	38	2,786								
K536	●	S50U DDQNL 15	63	50	350	65	35	47	5,166								

● Stokta/In Stock/Lager ○ Sınırlı Stok/Limited Stock/Begrenzte Lagerhaltung

Kalite için Teknik Çözüm | Technical Solution For Quality

BROTECH

TEKNİK
Cutting Tools

www.teknikcuttingtools.com

185

93° MDUNR

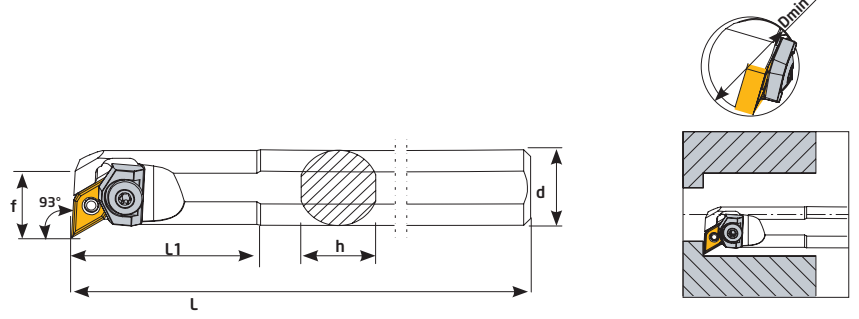

Sipariş Kodu Order Code Best.-Nr.	Stok/Stock/Lager	Ürün Kodu Product Code Produkt-Code	Ölçüler (mm) Dimensions(mm) Abmessungen (mm)							Uç Insert WSP	Baskı Civatası Locking Screw Verriegelungs Schraube	Pim Lock Pin Rohrstift	Baskı Kepli Clamp Spann pratze	Yay Spring Fede	Anahtar Allen Key Inbuss-Schlüs- sel
			Dmin	d	L	L1	f	h	ISO						
K408-1	●	S20R MDUNR 11	25	20	200	50	13	18	0,508	DN-- 1104	TC046 M5	BSP021	BK017	BY041	3 Allen

62,5° DDWNR

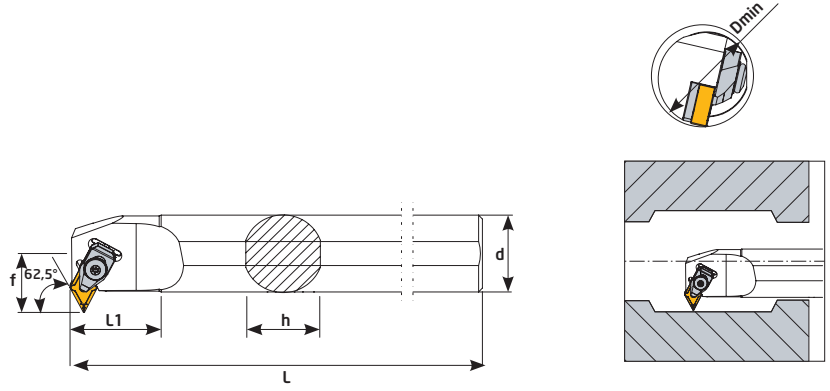
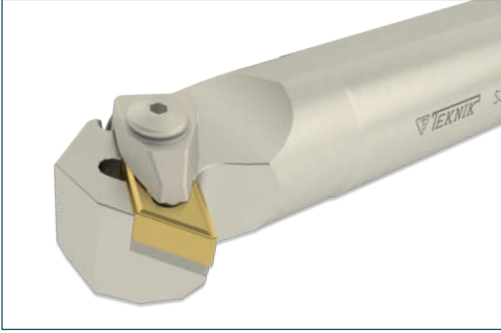

Sipariş Kodu Order Code Best.-Nr.	Stok/Stock/Lager	Ürün Kodu Product Code Produkt-Code	Ölçüler (mm) Dimensions(mm) Abmessungen (mm)							Uç Insert WSP	Baskı Civatası Locking Screw Verriegelungs Schraube	Altlık Shim U-Platte	Altlık Civatası Shim Screw U-Platte Schraube	Baskı Kepli Clamp Spann pratze	Yay Spring Feder	Pul Washer U-Scheibe	Anahtar Allen Key In- buss-Schlüs- sel
			Dmin	d	L	L1	f	h	ISO								
K464	●	S32T DDWNR 15	40	32	300	55	24	30	1,859	DN-- 1506	TC044 M6	TA014-1	TC038 M4x10	BK020	BY040	BSP030	3 Allen
K466	●	S40T DDWNR 15	50	40	300	50	30	38	2,918								
K468	●	S50U DDWNR 15	63	50	350	60	35	47	5,298								



60° MTENR

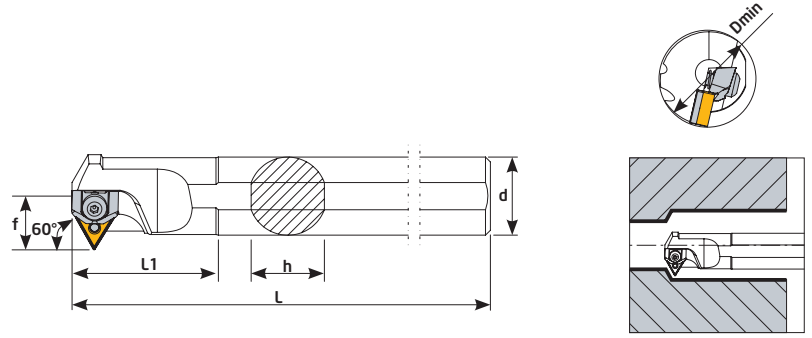
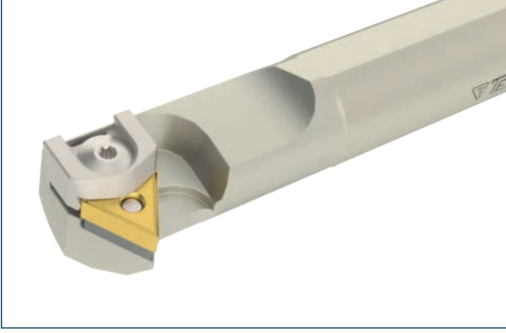

Sipariş Kodu Order Code Best.-Nr.	Stok/Stock/Lager	Ürün Kodu Product Code Produkt-Code	Ölçüler (mm) Dimensions (mm) Abmessungen (mm)							Uç Insert WSP	Baskı Civatası Locking Screw Verriegelungs-Schraube	Altlık Shim U-Platte	Altlık Pimi Lock Pin Rohrstift	Baskı Kepi Clamp Spannpratze	Yay Spring Feder	Pul Washer U-Scheibe	Anahtar Allen Key Inbuss-Schlüssel
			Dmin	d	L	L1	f	h	KG								
K456	●	S25S MTENR 16	32	25	250	55	17	23	0,960	TNMG 1604	TC046 M5	TA019	BSP 020	BK022	BY043	BSP031	3 Allen
K458	●	S32T MTENR 16	40	32	300	60	22	30	1,842								
K460	●	S40T MTENR 16	50	40	300	60	27	38	2,802								
K462	●	S50U MTENR 16	63	50	350	70	35	47	5,125								



● Stokta/In Stock/Lager ○ Sınırlı Stok/Limited Stock/Begrenzte Lagerhaltung

Kalite için Teknik Çözüm | Technical Solution For Quality

BROTECH

TEKNİK
Cutting Tools

www.teknikcuttingtools.com

187

93° MTUNR

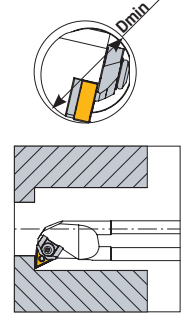
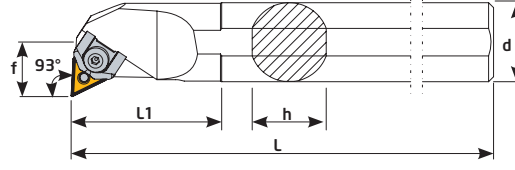
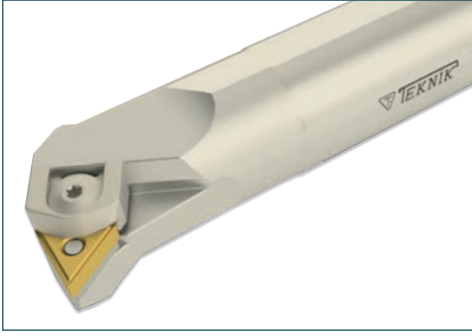

Sipariş Kodu Order Code Best.-Nr.	Stok/Stock/Lager	Ürün Kodu Product Code Produkt-Code	Ölçüler (mm) Dimensions(mm) Abmessungen (mm)							Uç Insert WSP	Baskı Civatası Locking Screw Verriegelungs Schraube	Altlık Shim U-Platte	Altlık Pimi Lock Pin Rohrstift	Baskı Kepi Clamp Spann pratze	Yay Spring Feder	Pul Washer U-Schei- be	Anahtar Allen Key Inbuss-Schlüssel
			Dmin	d	L	L1	f	h	kg								
K441	●	S20R MTUNR 16	25	20	200	50	13	18	0,513	TNMG 1604	TC043 M5	---	BSP019	BK017-1	BY041	BSP031	3 Allen
K442	●	S25S MTUNR 16	32	25	250	50	17	23	0,952		TC046 M5	TA019	BSP020	BK022	BY043		
K444	●	S32T MTUNR 16	40	32	300	60	22	30	1,835								
K446	●	S40T MTUNR 16	50	40	300	60	27	38	2,852								
K448	●	S50U MTUNR 16	63	50	350	65	35	47	5,150								
K450	●	S32T MTUNR 22	40	32	300	60	22	30	1,836	TNMG 2204	TC044 M6	TA045	BSP021	BK023	BY040	BSP030	3 Allen
K452	●	S40T MTUNR 22	50	40	300	60	27	38	2,814								
K454	●	S50U MTUNR 22	63	50	350	65	35	47	5,145								

93° MTUNL

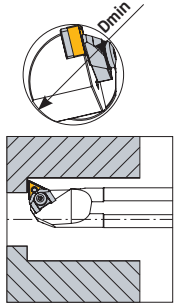
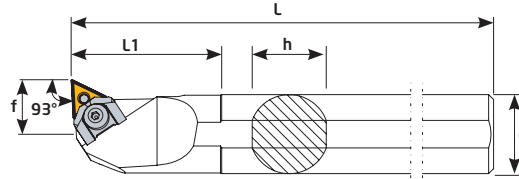

Sipariş Kodu Order Code Best.-Nr.	Stok/Stock/Lager	Ürün Kodu Product Code Produkt-Code	Ölçüler (mm) Dimensions(mm) Abmessungen (mm)							Uç Insert WSP	Baskı Civatası Locking Screw Verriegelungs Schraube	Altlık Shim U-Platte	Altlık Pimi Lock Pin Rohrstift	Baskı Kepi Clamp Spann pratze	Yay Spring Feder	Pul Washer U-Schei- be	Anahtar Allen Key Inbuss-Schlüssel
			Dmin	d	L	L1	f	h	kg								
K519	●	S20R MTUNL 16	25	20	200	30	13	18	0,513	TNMG 1604	TC043 M5	---	BSP019	BK017-1	BY041	BSP031	3 Allen
K520	●	S25S MTUNL 16	32	25	250	50	17	23	0,952		TC046 M5	TA019	BSP020	BK022	BY043		
K522	●	S32T MTUNL 16	40	32	300	60	22	30	1,835								
K524	●	S40T MTUNL 16	50	40	300	60	27	38	2,852								
K526	●	S50U MTUNL 16	63	50	350	65	35	47	5,150								
K528	●	S32T MTUNL 22	40	32	300	60	22	30	1,836	TNMG 2204	TC044 M6	TA045	BSP021	BK023	BY040	BSP030	3 Allen
K530	●	S40T MTUNL 22	50	40	300	60	27	38	2,814								
K532	●	S50U MTUNL 22	63	50	350	65	35	47	5,145								



107,5° MTQNR

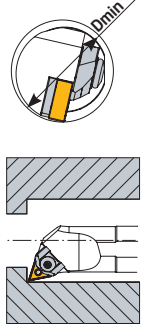
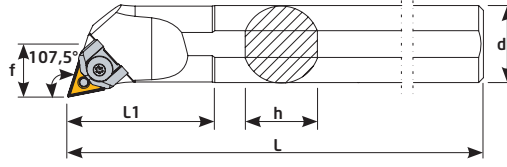

Sipariş Kodu Order Code Best.-Nr.	Stok/Stock/Lager	Ürün Kodu Product Code Produkt-Code	Ölçüler (mm) Dimensions(mm) Abmessungen (mm)							Uç Insert WSP	Baskı Civatası Locking Screw Verriegelungs Schraube	Altılık Shim U-Platte	Altılık Pimi Lock Pin Rohrstift	Baskı Kepi Clamp Spann pratze	Yay Spring Feder	Pul Washer U-Scheibe	Anahtar Allen Key Inbuss-Schlüssel
			Dmin	d	L	L1	f	h	kg								
K365	●	S25S MTQNR 16	32	25	250	50	17	23	0,942	TNMG 1604	TC046 M5	TA019	BSP020	BK022	BY043	BSP031	3 Allen
K366	●	S32T MTQNR 16	40	32	300	60	22	30	1,821								
K367	●	S40T MTQNR 16	50	40	300	60	27	38	2,807								
K368	●	S50U MTQNR 16	63	50	350	65	35	47	5,121								

107,5° MTQNL

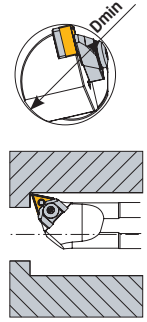
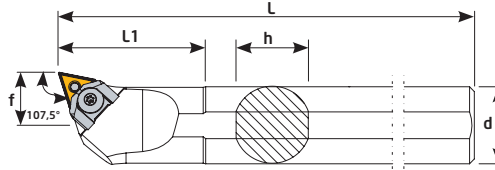

Sipariş Kodu Order Code Best.-Nr.	Stok/Stock/Lager	Ürün Kodu Product Code Produkt-Code	Ölçüler (mm) Dimensions(mm) Abmessungen (mm)							Uç Insert WSP	Baskı Civatası Locking Screw Verriegelungs Schraube	Altılık Shim U-Platte	Altılık Pimi Lock Pin Rohrstift	Baskı Kepi Clamp Spann pratze	Yay Spring Feder	Pul Washer U-Scheibe	Anahtar Allen Key Inbuss-Schlüssel
			Dmin	d	L	L1	f	h	kg								
K537	●	S25S MTQNL 16	32	25	250	50	17	23	0,942	TNMG 1604	TC046 M5	TA019	BSP020	BK022	BY043	BSP031	3 Allen
K538	●	S32T MTQNL 16	40	32	300	60	22	30	1,821								
K539	●	S40T MTQNL 16	50	40	300	60	27	38	2,807								
K540	●	S50U MTQNL 16	63	50	350	65	35	47	5,121								

95° MWLNR

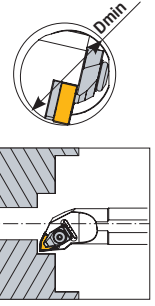
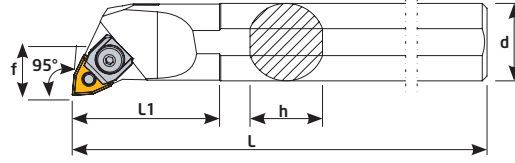
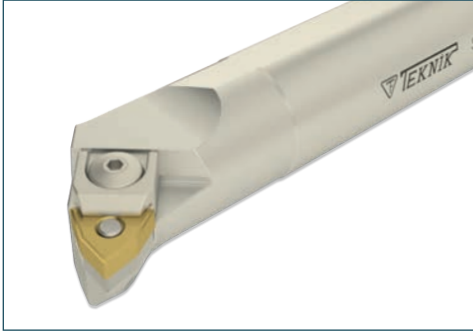

Sipariş Kodu Order Code Best.-Nr.	Stok/Stock/Lager	Ürün Kodu Product Code Produkt-Code	Ölçüler (mm) Dimensions (mm) Abmessungen (mm)							Uç Insert WSP	Baskı Civatası Locking Screw Verriegelungs Schraube	Altlık Shim U-Platte	Altlık Pimi Lock Pin Rohrstift	Baskı Kepi Clamp Spann pratze	Yay Spring Feder	Pul Washer U-Scheibe	Anahtar Allen Key Inbuss-Schlüssel
			Dmin	d	L	L1	f	h	kg								
K427	●	S16Q MWLNR 06	20	16	180	40	11	15	0,286	WN-- 0604	TC046 M5	--	BSP020	BK019	BY041	BSP031	3 Allen
K427-1	●	S20R MWLNR 06	25	20	200	50	13	18	0,502								
K428	●	S25S MWLNR 08	32	25	250	45	17	23	0,945	WN-- 0804	TC044 M6	TA020	BSP021	BK026	BY040	BSP030	3 Allen
K430	●	S32T MWLNR 08	40	32	300	60	22	30	1,833								
K432	●	S40T MWLNR 08	50	40	300	60	27	38	2,841								
K434	●	S50U MWLNR 08	63	50	350	65	35	47	5,110								

95° MWLNL

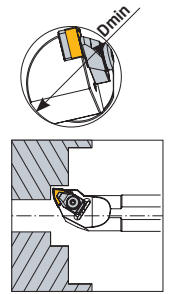
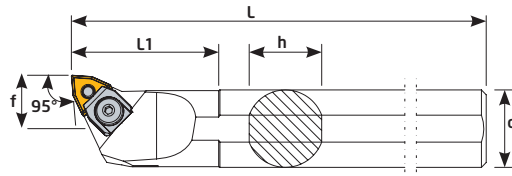
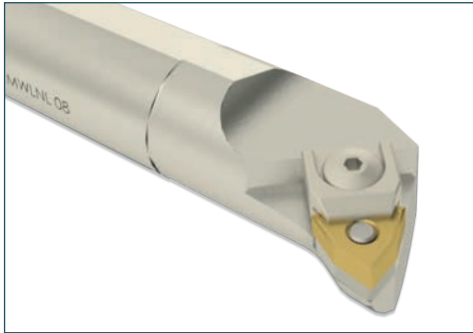

Sipariş Kodu Order Code Best.-Nr.	Stok/Stock/Lager	Ürün Kodu Product Code Produkt-Code	Ölçüler (mm) Dimensions (mm) Abmessungen (mm)							Uç Insert WSP	Baskı Civatası Locking Screw Verriegelungs Schraube	Altlık Shim U-Platte	Altlık Pimi Lock Pin Rohrstift	Baskı Kepi Clamp Spann pratze	Yay Spring Feder	Pul Washer U-Scheibe	Anahtar Allen Key Inbuss-Schlüssel
			Dmin	d	L	L1	f	h	kg								
K510	●	S25S MWLNL 08	32	25	250	45	17	23	0,945	WN-- 0804	TC044 M6	TA020	BSP021	BK026	BY040	BSP030	3 Allen
K512	●	S32T MWLNL 08	40	32	300	60	22	30	1,833								
K514	●	S40T MWLNL 08	50	40	300	60	27	38	2,841								
K516	●	S50U MWLNL 08	63	50	350	65	35	47	5,110								

● Stokta/In Stock/Lager ○ Sınırlı Stok/Limited Stock/Begrenzte Lagerhaltung



95° DWLNR

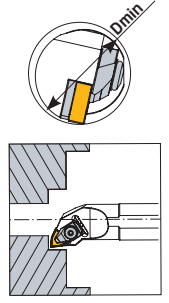
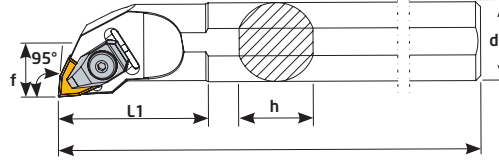

Sipariş Kodu Order Code Best.-Nr.	Stok/Stock/Lager	Ürün Kodu Product Code Produkt-Code	Ölçüler (mm) Dimensions(mm) Abmessungen (mm)							Uç Insert WSP	Baskı Cıvatası Locking Screw Verriegelungs Schraube	Altlık Shim U-Platte	Altlık Cıvatası Shim Screw U-Platte Schraube	Baskı Kepi Clamp Spann pratze	Yay Spring Feder	Pul Washer U-Scheibe	Anahtar Allen Key Inbuss-Schlüssel
			Dmin	d	L	L1	f	h	kg								
K418	●	S25S DWLNR 06	32	25	250	50	17	23	0,955	WN--0604	TC046 M5	TA021	TC034 M3x7	BK024	BY041	BSP031	3 Allen
K420	●	S25S DWLNR 08	32	25	250	50	17	23	0,966	WN--0804	TC044 M6	TA020-1	TC038 M4x10	BK020	BY040	BSP030	3 Allen
K422	●	S32T DWLNR 08	40	32	300	60	22	30	1,837								
K424	●	S40T DWLNR 08	50	40	300	60	27	38	2,820								
K426	●	S50U DWLNR 08	63	50	350	75	35	47	5,123								

95° DWLNL

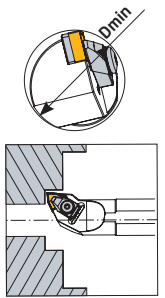
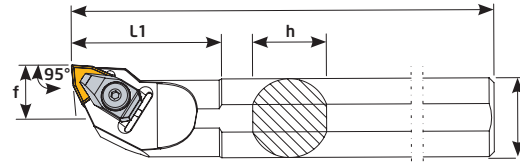

Sipariş Kodu Order Code Best.-Nr.	Stok/Stock/Lager	Ürün Kodu Product Code Produkt-Code	Ölçüler (mm) Dimensions(mm) Abmessungen (mm)							Uç Insert WSP	Baskı Cıvatası Locking Screw Verriegelungs Schraube	Altlık Shim U-Platte	Altlık Cıvatası Shim Screw U-Platte Schraube	Baskı Kepi Clamp Spann pratze	Yay Spring Feder	Pul Washer U-Scheibe	Anahtar Allen Key Inbuss-Schlüssel
			Dmin	d	L	L1	f	h	kg								
K498	●	S25S DWLNL 06	32	25	250	50	17	23	0,955	WN--0604	TC046 M5	TA021	TC034 M3x7	BK024	BY041	BSP031	3 Allen
K500	●	S25S DWLNL 08	32	25	250	50	17	23	0,966	WN--0804	TC044 M6	TA020-1	TC038 M4x10	BK020	BY040	BSP030	3 Allen
K502	●	S32T DWLNL 08	40	32	300	60	22	30	1,837								
K504	●	S40T DWLNL 08	50	40	300	60	27	38	2,820								
K506	●	S50U DWLNL 08	63	50	350	75	35	47	5,123								

● Stokta/ In Stock/ Lager ○ Sınırlı Stok/ Limited Stock/ Begrenzte Lagerhaltung

Kalite için Teknik Çözüm | Technical Solution For Quality



www.teknikcuttingtools.com

95° DCLNR

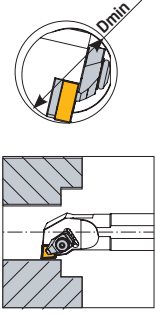
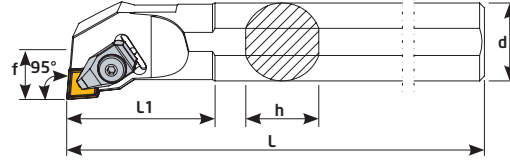
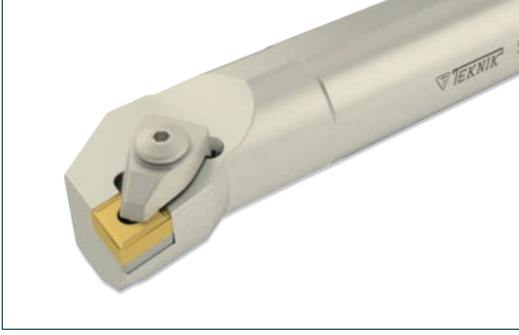

Sipariş Kodu Order Code Best.-Nr.	Stok/Stock/Lager	Ürün Kodu Product Code Produkt-Code	Ölçüler (mm) Dimensions(mm) Abmessungen (mm)							Uç Insert WSP	Baskı Civatası Locking Screw Verriegelungs Schraube	Altık Shim U-Platte	Altık Civatası Shim Screw U-Platte Schraube	Baskı Kepi Clamp Spann pratze	Yay Spring Feder	Pul Washer U-Scheibe	Anahtar Allen Key Inbuss-Schlüssel		
			Dmin	d	L	L1	f	h	Ⓢ										
K400	●	S25S DCLNR 12	32	25	250	50	17	23	0,964	CN-- 1204	TC044 M6	TA016-1	TC038 M4x10	BK020	BY040	BSP030	3 Allen		
K402	●	S32T DCLNR 12	40	32	300	60	22	30	1,867										
K404	●	S40T DCLNR 12	50	40	300	60	27	38	2,845										
K406	●	S50U DCLNR 12	63	50	350	60	35	47	5,166										
K370	●	S32U DCLNR 16	40	32	350	60	22	30	2,272			CN-- 1606	TA022	TC095 M5x11,8	BK018	BY040		BSP030	
K371	●	S40U DCLNR 16	50	40	350	60	27	38	3,550										
K374	●	S40U DCLNR 19	50	40	350	60	27	38	3,503			CN-- 1906	TC048 M8	TA017	TC039 M6x12	BK025		BY044	BSP032
K375	●	S50V DCLNR 19	63	50	400	60	35	47	6,333										

95° DCLNL

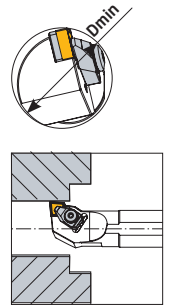
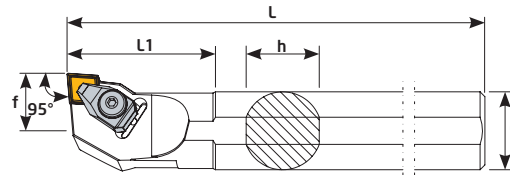

Sipariş Kodu Order Code Best.-Nr.	Stok/Stock/Lager	Ürün Kodu Product Code Produkt-Code	Ölçüler (mm) Dimensions(mm) Abmessungen (mm)							Uç Insert WSP	Baskı Civatası Locking Screw Verriegelungs Schraube	Altık Shim U-Platte	Altık Civatası Shim Screw U-Platte Schraube	Baskı Kepi Clamp Spann pratze	Yay Spring Feder	Pul Washer U-Scheibe	Anahtar Allen Key Inbuss-Schlüssel
			Dmin	d	L	L1	f	h	Ⓢ								
K480	●	S25S DCLNL 12	32	25	250	50	17	23	0,964	CN-- 1204	TC044 M6	TA016-1	TC038 M4x10	BK020	BY040	BSP030	3 Allen
K482	●	S32T DCLNL 12	40	32	300	60	22	30	1,867								
K484	●	S40T DCLNL 12	50	40	300	60	27	38	2,845								
K486	●	S50U DCLNL 12	63	50	350	60	35	47	5,166								



75° DCKNR

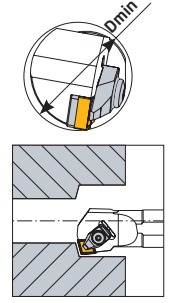
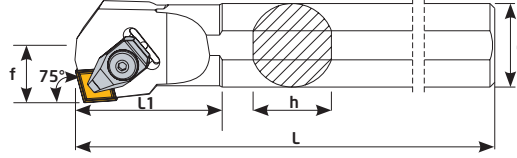

Sipariş Kodu Order Code Best.-Nr.	Stok/Stock/Lager	Ürün Kodu Product Code Produkt-Code	Ölçüler (mm) Dimensions(mm) Abmessungen (mm)							Uç Insert WSP	Baskı Civatası Locking Screw Verriegelungs Schraube	Altlık Shim U-Platte	Altlık Civatası Shim Screw U-Platte Schraube	Baskı Keki Clamp Spann pratze	Yay Spring Feder	Pul Washer U-Schei- be	Anahtar Allen Key Inbuss-Schlüs- sel
			Dmin	d	L	L1	f	h	kg								
K401	●	S25S DCKNR 12	32	25	250	55	17	23	0,955	CN-- 1204	TC044 M6	TA016-1	TC038 M4x10	BK020	BY040	BSP030	3 Allen
K403	●	S32T DCKNR 12	40	32	300	60	22	30	0,966								
K405	●	S40T DCKNR 12	50	40	300	65	27	38	1,837								

93° CKUNR

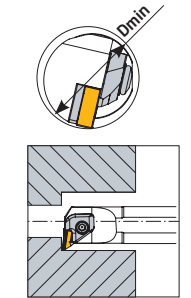
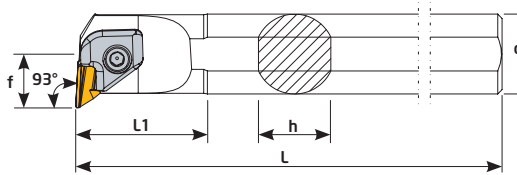

Sipariş Kodu Order Code Best.-Nr.	Stok/Stock/Lager	Ürün Kodu Product Code Produkt-Code	Ölçüler (mm) Dimensions(mm) Abmessungen (mm)							Uç Insert WSP	Baskı Civatası Locking Screw Verriegelungs Schraube	Altlık Shim U-Platte	Altlık Civatası Shim Screw U-Platte Schraube	Baskı Keki Clamp Spann pratze	Yay Spring Feder	Pul Washer U-Scheibe	Anahtar Allen Key Inbuss-Schlüssel
			Dmin	d	L	L1	f	h	kg								
RK750	●	S25T CKUNR 16	32	25	300	52	19	23	1,400	KNUX 1604	TC044 M6	TA048	TC036 M3x10	BK030	BY042	BSP030	3 Allen
RK754	●	S32U CKUNR 16	40	32	350	52	21	30	2,264								
RK756	●	S40V CKUNR 16	50	40	400	55	27	38	3,999								
RK758	●	S45V CKUNR 16	54	45	400	60	29	41	4,924								
RK760	●	S50W CKUNR 16	63	50	450	60	35	47	0,408								

● Stokta/In Stock/Lager ○ Sınırlı Stok/Limited Stock/Begrenzte Lagerhaltung

Kalite için Teknik Çözüm | Technical Solution For Quality

BROTECH

TEKNİK
Cutting Tools

www.teknikcuttingtools.com

193

Kalite için TEKNİK çözüm
Technical solution for quality



teknikcuttingtools.com

Uç Bağlama Sistemleri | Insert Clamping Systems Wendeplatten klem systems



A-S Sistem İç Çap Kater
A-S System Boring Bars
A-S System Bohrstange



**Technical Solution
for Quality**



95° SCLCR IC

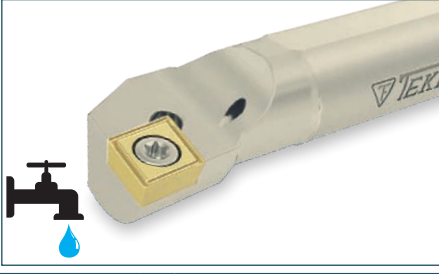

İçten Soğutmalı İç Çap Kater Boring Bars With Coolant

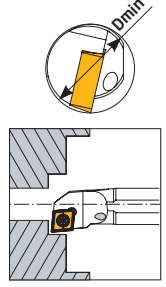
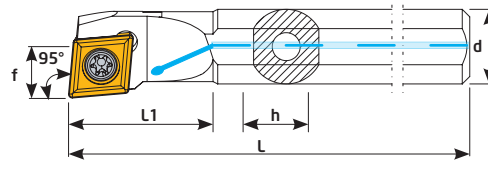

Sipariş Kodu Order Code Best.-Nr.	Stok/Stock/Lager	Ürün Kodu Product Code	Ölçüler (mm) Dimensions (mm) Abmessungen (mm)						Kullanılan Uç Insert WSP	Sıkma Cıvatası Clamp Screw Torx-Schraube	Anahtar Torx Key Torx-Schlüssel	
			Dmin	d	L	L1	f	h				kg
KA102	●	A08H SCLCR 06	10	8	100	16	5,5	7	0,050	CC-- 0602	TC060 M2,5x5,5	T8
KA104	●	A10J SCLCR 06	12	10	110	20	6	9	0,074			
KA106	●	A12K SCLCR 06	16	12	125	25	9	11	0,113			
KA108	●	A14-16Q SCLCR 09	18	16	180	45	9,5	15	0,267	CC-- 09T3	TC067 M3,5x8,5	T15
KA110	●	A16Q SCLCR 09	20	16	180	30	11	15	0,260			
KA111	●	A16M SCLCR 09	20	16	150	30	11	15	0,227			
KA114	●	A20Q SCLCR 09	25	20	180	40	13	18	0,422			
KA116	●	A25R SCLCR 09	32	25	200	40	17	23	0,734			

95° SCLCR

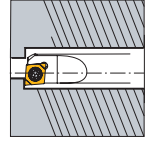
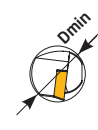
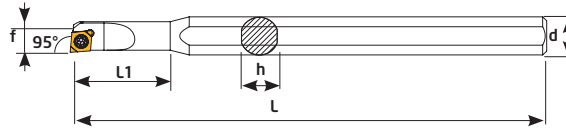
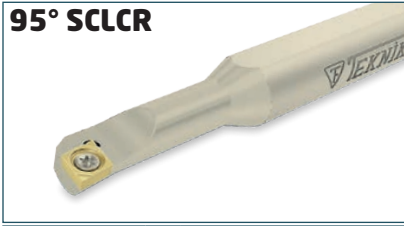

Sipariş Kodu Order Code Best.-Nr.	Stok/Stock/Lager	Ürün Kodu Product Code	Ölçüler (mm) Dimensions (mm) Abmessungen (mm)						Kullanılan Uç Insert WSP	Sıkma Cıvatası Clamp Screw Torx-Schraube	Anahtar Torx Key Torx-Schlüssel	
			Dmin	d	L	L1	f	h				kg
K097	●	S05-08H SCLCR 03	5	8	100	15	2,5	7,3	0,046	CC-- 0301	TC057 M1,6	T6
K098	●	S06-08H SCLCR 03	6	8	100	18	3	7,3	0,048			
K099	●	S07-08H SCLCR 04	7	8	100	21	3,5	7,3	0,050			

95° SCLCR

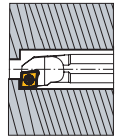
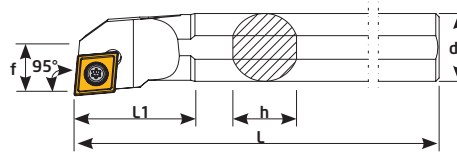

Sipariş Kodu Order Code Best.-Nr.	Stok/Stock/Lager	Ürün Kodu Product Code	Ölçüler (mm) Dimensions (mm) Abmessungen (mm)						Kullanılan Uç Insert WSP	Sıkma Cıvatası Clamp Screw Torx-Schraube	Anahtar Torx Key Torx-Schlüssel	
			Dmin	d	L	L1	f	h				kg
K100	●	S06-08H SCLCR 06	10	8	100	25	4,3	7,3	0,052	CC-- 0602	TC059-1 M2,5 x4,7	T8
K102	●	S08H SCLCR 06	10	8	100	16	5,5	7,3	0,053			
K104	●	S10J SCLCR 06	12	10	110	20	6	9	0,080			
K105	●	S10K SCLCR 06	12	10	125	20	6	9	0,085			
K106	●	S12K SCLCR 06	16	12	125	25	9	11	0,120			
K107	●	S12Q SCLCR 06	16	12	180	25	9	11	0,170	CC-- 09T3	TC067 M3,5x8,5	T15
K107-1	●	S12K SCLCR 09	16	12	125	24	9	11	0,271			
K108	●	S14-16Q SCLCR 09	18	16	180	45	9,5	15	0,285			
K110	●	S16Q SCLCR 09	20	16	180	30	11	15	0,317			
K111	●	S16R SCLCR 09	20	16	200	30	11	15	0,329			
K112	●	S18-20Q SCLCR 09	21	20	180	38	11	18	0,436			
K114	●	S20Q SCLCR 09	25	20	180	40	11	18	0,612			
K115	●	S20S SCLCR 09	25	20	250	40	13	18	0,780			
K116	●	S25R SCLCR 09	32	25	200	40	17	23	0,694			
K117	●	S25T SCLCR 09	32	25	300	40	17	23	1,165			
K116-1	●	S25S SCLCR 12	32	25	250	45	17	23	0,965	CC--1204	TC083 M5x12	T20



95° SCLCL IC



İçten Soğutmalı İç Çap Kater Boring Bars With Coolant

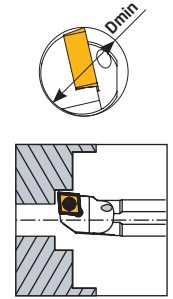
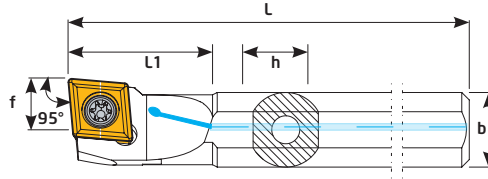

Sipariş Kodu Order Code Best.-Nr.	Stok/Stock/Lager	Ürün Kodu Product Code Produkt-Code	Ölçüler (mm) Dimensions(mm) Abmessungen (mm)							Kullanılan Uç Insert WSP	Sıkma Civatası Clamp Screw Torx-Schraube	Anahtar Torx Key Torx-Schlüssel
			Dmin	d	L	L1	f	h				
KA232	●	A08H SCLCL 06	10	8	100	16	5,5	7	0,050	CC-- 0602	TC060 M2,5x5,5	T8
KA234	●	A10J SCLCL 06	12	10	110	20	6	9	0,074			
KA236	●	A12K SCLCL 06	16	12	125	25	9	11	0,113			
KA238	●	A14-16Q SCLCL 09	18	16	180	45	9,5	15	0,268	CC-- 09T3	TC067 M3,5x8,5	T15
KA239	●	A16M SCLCL 09	20	16	150	30	11	15	0,227			
KA240	●	A16Q SCLCL 09	20	16	180	30	11	15	0,260			
KA244	●	A20Q SCLCL 09	25	20	180	40	13	18	0,422			
KA246	●	A25R SCLCL 09	32	25	200	40	17	23	0,734			

95° SCLCL

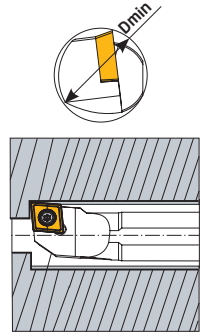
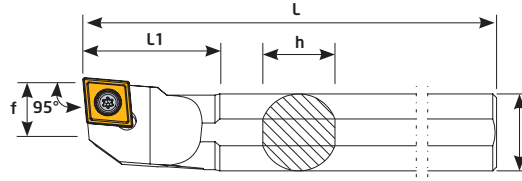

Sipariş Kodu Order Code Best.-Nr.	Stok/Stock/Lager	Ürün Kodu Product Code Produkt-Code	Ölçüler (mm) Dimensions(mm) Abmessungen (mm)							Kullanılan Uç Insert WSP	Sıkma Civatası Clamp Screw Torx-Schraube	Anahtar Torx Key Torx-Schlüssel
			Dmin	d	L	L1	f	h				
K230	●	S06-08H SCLCL 06	9	8	100	25	4,3	7,3	0,052	CC-- 0602	TC060 M2,5x5,5	T8
K232	●	S08H SCLCL 06	10	8	100	16	5,5	7,3	0,053			
K234	●	S10J SCLCL 06	12	10	110	20	6	9	0,080			
K236	●	S12K SCLCL 06	16	12	125	25	9	11	0,120			
K238	●	S14-16Q SCLCL 09	18	16	180	45	9,5	15	0,271	CC--09T3	TC067 M3,5x8,5	T15
K240	●	S16Q SCLCL 09	20	16	180	30	11	15	0,285			
K241	●	S16R SCLCL 09	20	16	200	30	11	15	0,317			
K244	●	S20Q SCLCL 09	25	20	180	40	13	18	0,436			
K245	●	S20S SCLCL 09	25	20	250	40	13	18	0,612			
K246	●	S25R SCLCL 09	32	25	200	40	17	23	0,780			

● Stokta/ In Stock/ Lager ○ Sınırlı Stok/ Limited Stock/ Begrenzte Lagerhaltung

Kalite için Teknik Çözüm | Technical Solution For Quality



www.teknikcuttingtools.com

197

93° SDUCR IC



İçten Soğutmalı İç Çap Kater Boring Bars With Coolant

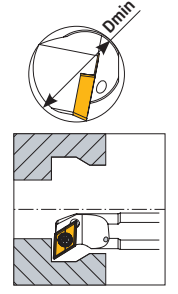
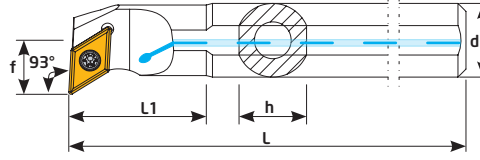

Sipariş Kodu Order Code Best.-Nr.	Stok/Stock/Lager	Ürün Kodu Product Code Produkt-Code	Ölçüler (mm) Dimensions(mm) Abmessungen (mm)							Kullanılan Uç Insert WSP	Sıkma Cıvatası Clamp Screw Torx-Schraube	Anahtar Torx Key Torx-Schlüssel
			Dmin	d	L	L1	f	h	KG			
KA120	●	A10J SDUCR 07	12	10	110	20	7	9	0,080	DC--0702	TC060 M2,5x5,5	T8
KA122	●	A12K SDUCR 07	16	12	125	25	9	11	0,120			
KA124	●	A14-16Q SDUCR 07	18	16	180	40	10,5	15	0,267			
KA126	●	A16Q SDUCR 07	20	16	180	30	11	15	0,263			
KA127	●	A16M SDUCR 07	20	16	150	30	11	15	0,250			
KA128	●	A16Q SDUCR 11	20	16	180	30	11	15	0,285	DC--11T3	TC067 M3,5x8,5	T15
KA129	●	A16M SDUCR 11	20	16	150	30	11	15	0,246			
KA130	●	A20Q SDUCR 11	25	20	180	32	13	18	0,432			
KA132	●	A25R SDUCR 11	32	25	200	40	17	23	0,746			
KA134	●	A32T SDUCR 11	40	32	300	45	22	30	1,924			

93° SDUCR

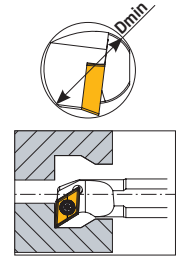
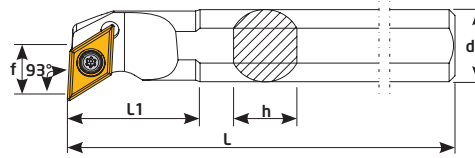

Sipariş Kodu Order Code Best.-Nr.	Stok/Stock/Lager	Ürün Kodu Product Code Produkt-Code	Ölçüler (mm) Dimensions(mm) Abmessungen (mm)							Kullanılan Uç Insert WSP	Sıkma Cıvatası Clamp Screw Torx-Schraube	Anahtar Torx Key Torx-Schlüssel
			Dmin	d	L	L1	f	h	KG			
K120	●	S10J SDUCR 07	12	10	110	20	7	9	0,080	DC-- 0702	TC060 M2,5x5,5	T8
K122	●	S12K SDUCR 07	16	12	125	25	9	11	0,120			
K123	●	S12Q SDUCR 07	16	12	180	25	9	11	0,170			
K124	●	S14-16Q SDUCR 07	18	16	180	40	11	15	0,266			
K126	●	S16Q SDUCR 07	20	16	180	30	11	15	0,292			
K125	●	S14-16Q SDUCR 11	18	16	180	45	11	15	0,272	DC--11T3	TC067 M3,5x8,5	T15
K128	●	S16Q SDUCR 11	20	16	180	30	11	15	0,285			
K129	●	S16M SDUCR 11	20	16	150	30	11	15	0,246			
K130	●	S20Q SDUCR 11	25	20	180	32	13	18	0,435			
K132	●	S25R SDUCR 11	32	25	200	40	17	23	0,748			
K134	●	S32T SDUCR 11	40	32	300	45	22	30	1,833			

● Stokta/ In Stock/ Lager ○ Sınırlı Stok/ Limited Stock/ Begrenzte Lagerhaltung



93° SDUCL IC



İçten Soğutmalı İç Çap Kater Boring Bars With Coolant

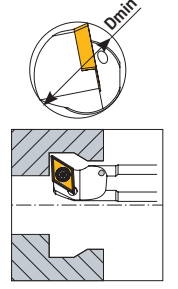
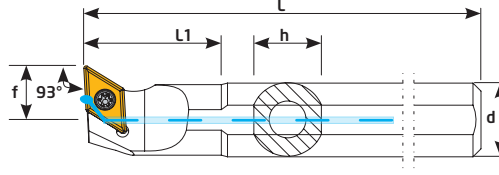

Sipariş Kodu Order Code Best.-Nr.	Stok/Stock/Lager	Ürün Kodu Product Code Produkt-Code	Ölçüler (mm) Dimensions(mm) Abmessungen (mm)							Kullanılan Uç Insert WSP	Sıkma Civatası Clamp Screw Torx-Schraube	Anahtar Torx Key Torx-Schlüssel
			Dmin	d	L	L1	f	h	kg			
KA250	●	A10J SDUCL 07	12	10	110	20	7	9	0,080	DC--0702	TC060 M2,5x5,5	T8
KA252	●	A12K SDUCL 07	16	12	125	25	9	11	0,120			
KA254	●	A14-16Q SDUCL 07	18	16	180	40	10,5	15	0,267			
KA256	●	A16Q SDUCL 07	20	16	180	30	11	15	0,263			
KA258	●	A16Q SDUCL 11	20	16	180	30	11	15	0,285	DC--11T3	TC067 M3,5x8,5	T15
KA259	●	A16M SDUCL 11	20	16	150	30	11	15	0,246			
KA260	●	A20Q SDUCL 11	25	20	180	32	13	18	0,432			
KA262	●	A25R SDUCL 11	32	25	200	40	17	23	0,746			
KA263	●	A32T SDUCL 11	40	32	300	45	22	30	1,924			

93° SDUCL

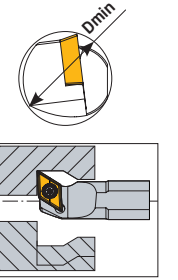
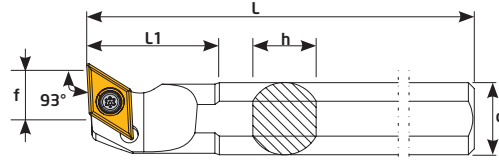

Sipariş Kodu Order Code Best.-Nr.	Stok/Stock/Lager	Ürün Kodu Product Code Produkt-Code	Ölçüler (mm) Dimensions(mm) Abmessungen (mm)							Kullanılan Uç Insert WSP	Sıkma Civatası Clamp Screw Torx-Schraube	Anahtar Torx Key Torx-Schlüssel
			Dmin	d	L	L1	f	h	kg			
K250	●	S10J SDUCL 07	12	10	110	20	7	9	0,080	DC-- 0702	TC060 M2,5x5,5	T8
K252	●	S12K SDUCL 07	16	12	125	25	9	11	0,120			
K254	●	S14-16Q SDUCL 07	18	16	180	40	10,5	15	0,266			
K256	●	S16Q SDUCL 07	20	16	180	30	11	15	0,292			
K258	●	S16Q SDUCL 11	20	16	180	30	11	15	0,285	DC--11T3	TC067 M3,5x8,5	T15
K259	●	S16M SDUCL 11	20	16	150	30	11	15	0,246			
K260	●	S20Q SDUCL 11	25	20	180	32	13	18	0,435			
K262	●	S25R SDUCL 11	32	25	200	40	17	23	0,748			
K263	●	S32T SDUCL 11	40	32	300	45	22	30	1,833			

● Stokta/ In Stock/ Lager ○ Sınırlı Stok/ Limited Stock/ Begrenzte Lagerhaltung

Kalite için Teknik Çözüm | Technical Solution For Quality



www.teknikcuttingtools.com

199

107,5° SDQCR IC



İçten Soğutmalı İç Çap Kater Boring Bars With Coolant

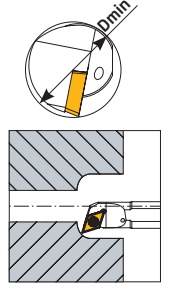
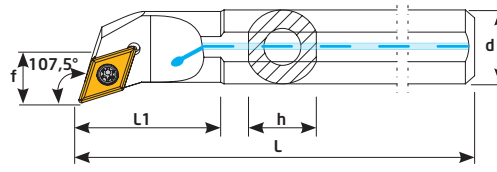

Sipariş Kodu Order Code Best.-Nr.	Stok/Stock/Lager	Ürün Kodu Product Code Produkt-Code	Ölçüler (mm) Dimensions(mm) Abmessungen (mm)							Kullanılan Uç Insert WSP	Sıkma Cıvatası Clamp Screw Torx-Schraube	Anahtar Torx Key Torx-Schlüssel
			Dmin	d	L	L1	f	h	kg			
KA140	●	A10J SDQCR 07	12	10	110	20	7	9	0,074	DC--0702	TC060 M2,5x5,5	T8
KA142	●	A12K SDQCR 07	16	12	125	25	9	11	0,110			
KA143	●	A16M SDQCR 07	20	16	150	30	11	15	0,232			
KA144	●	A16Q SDQCR 07	20	16	180	30	11	15	0,282			
KA146	●	A16Q SDQCR 11	20	16	180	30	11	15	0,275	DC--11T3	TC067 M3,5x8,5	T15
KA148	●	A20Q SDQCR 11	25	20	180	32	13	18	0,425			
KA150	●	A25R SDQCR 11	32	25	200	40	17	23	0,738			

107,5° SDQCR

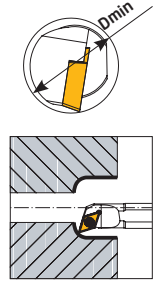
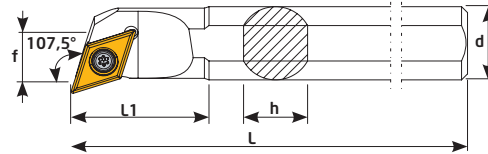

Sipariş Kodu Order Code Best.-Nr.	Stok/Stock/Lager	Ürün Kodu Product Code Produkt-Code	Ölçüler (mm) Dimensions(mm) Abmessungen (mm)							Kullanılan Uç Insert WSP	Sıkma Cıvatası Clamp Screw Torx-Schraube	Anahtar Torx Key Torx-Schlüssel
			Dmin	d	L	L1	f	h	kg			
K140	●	S10J SDQCR 07	12	10	110	20	7	9	0,080	DC--0702	TC060 M2,5x5,5	T8
K142	●	S12K SDQCR 07	16	12	125	25	9	11	0,120			
K144	●	S16Q SDQCR 07	20	16	180	30	11	15	0,292			
K146	●	S16Q SDQCR 11	20	16	180	30	11	15	0,285	DC--11T3	TC067 M3,5x8,5	T15
K148	●	S20Q SDQCR 11	25	20	180	32	13	18	0,435			
K150	●	S25R SDQCR 11	32	25	200	40	17	23	0,748			
K152	●	S32T SDQCR 11	40	32	300	50	22	30	1,833			
K154	●	S40T SDQCR 11	50	40	300	50	27	38	0,268			



107,5° SDQCL IC

İçten Soğutmalı İç Çap Kater Boring Bars With Coolant

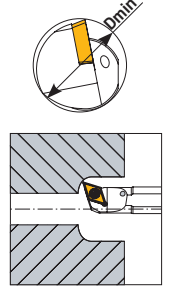
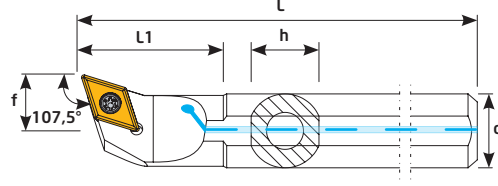

Sipariş Kodu Order Code Best.-Nr.	Stok/Stock/Lager	Ürün Kodu Product Code Produkt-Code	Ölçüler (mm) Dimensions(mm) Abmessungen (mm)							Kullanılan Uç Insert WSP	Sıkma Civatası Clamp Screw Torx-Schraube	Anahtar Torx Key Torx-Schlüssel
			Dmin	d	L	L1	f	h	kg			
KA270	●	A10J SDQCL 07	12	10	110	20	7	9	0,074	DC--0702	TC060 M2,5x5,5	T8
KA272	●	A12K SDQCL 07	16	12	125	25	9	11	0,110			
KA273	●	A16M SDQCL 07	20	16	150	30	11	15	0,232			
KA274	●	A16Q SDQCL 07	20	16	180	30	11	15	0,282			
KA276	●	A16Q SDQCL 11	20	16	180	30	11	15	0,275	DC--11T3	TC067 M3,5x8,5	T15
KA278	●	A20Q SDQCL 11	25	20	180	32	13	18	0,425			
KA280	●	A25R SDQCL 11	32	25	200	40	17	23	0,738			

107,5° SDQCL

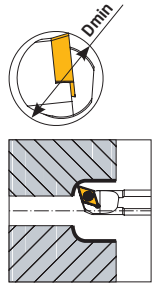
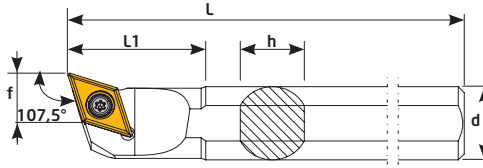

Sipariş Kodu Order Code Best.-Nr.	Stok/Stock/Lager	Ürün Kodu Product Code Produkt-Code	Ölçüler (mm) Dimensions(mm) Abmessungen (mm)							Kullanılan Uç Insert WSP	Sıkma Civatası Clamp Screw Torx-Schraube	Anahtar Torx Key Torx-Schlüssel
			Dmin	d	L	L1	f	h	kg			
K270	●	S10J SDQCL 07	12	10	110	20	7	9	0,080	DC--0702	TC060 M2,5x5,5	T8
K272	●	S12K SDQCL 07	16	12	125	25	9	11	0,120			
K274	●	S16Q SDQCL 07	20	16	180	30	11	15	0,292			
K276	●	S16Q SDQCL 11	20	16	180	30	11	15	0,285			
K278	●	S20Q SDQCL 11	25	20	180	32	13	18	0,435	DC--11T3	TC067 M3,5x8,5	T15
K280	●	S25R SDQCL 11	32	25	200	40	17	23	0,748			
K281	●	S32T SDQCL 11	40	32	300	50	22	30	1,833			

● Stokta/ In Stock/ Lager ○ Sınırlı Stok/ Limited Stock/ Begrenzte Lagerhaltung

Kalite için Teknik Çözüm | Technical Solution For Quality



www.teknikcuttingtools.com

120° SDXCR

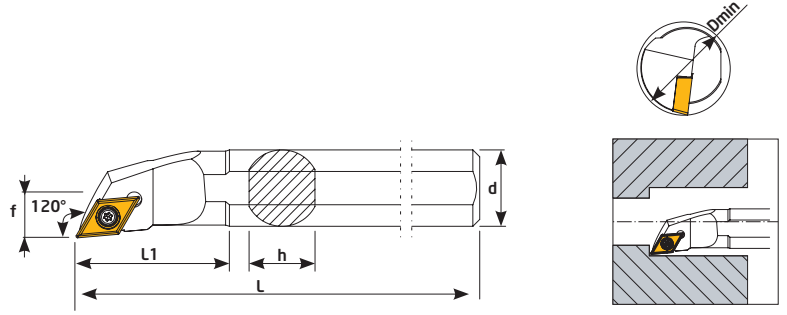

Sipariş Kodu Order Code Best.-Nr.	Stok/Stock/Lager	Ürün Kodu Product Code Produkt-Code	Ölçüler (mm) Dimensions(mm) Abmessungen (mm)							Kullanılan Uç Insert WSP	Sıkma Civatası Clamp Screw Torx-Schraube	Anahtar Torx Key Torx-Schlüssel
			Dmin	d	L	L1	f	h	kg			
K469	●	S10J SDXCR 07	12	10	110	25	5,5	9	0,080	DC-- 0702	TC060 M2,5x5,5	T8
K470	●	S12K SDXCR 07	16	12	125	30	9	11	0,120			
K471	●	S16Q SDXCR 11	20	16	180	40	11	15	0,285	DC--11T3	TC067 M3,5x8,5	T15
K472	●	S20Q SDXCR 11	25	20	180	40	13	18	0,435			
K473	●	S25R SDXCR 11	32	25	200	50	13,5	23	0,748			
K474	●	S32T SDXCR 11	40	32	300	55	17	30	1,833			
K475	●	S40T SDXCR 11	50	40	300	55	21	38	0,268			

62,5° SD-CR

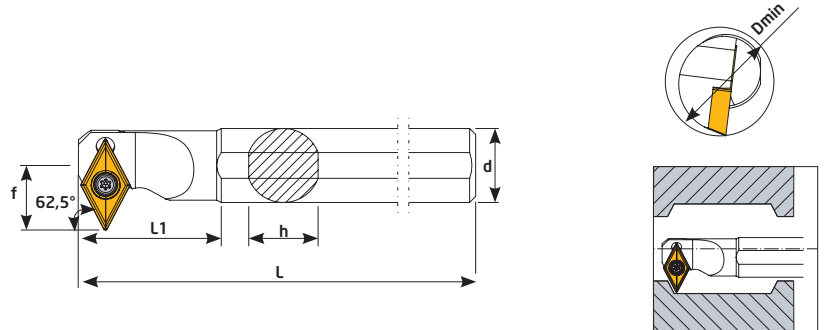
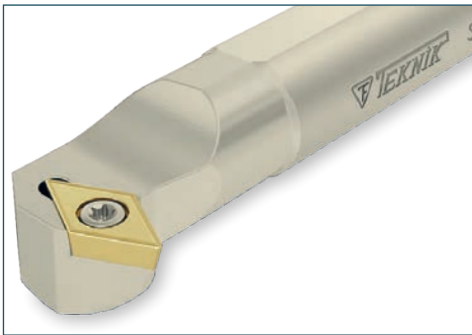

Sipariş Kodu Order Code Best.-Nr.	Stok/Stock/Lager	Ürün Kodu Product Code Produkt-Code	Ölçüler (mm) Dimensions(mm) Abmessungen (mm)							Kullanılan Uç Insert WSP	Sıkma Civatası Clamp Screw Torx-Schraube	Anahtar Torx Key Torx-Schlüssel
			Dmin	d	L	L1	f	h	kg			
K168	●	S10J SD-CR 07	14	10	110	25	8,2	9	0,082	DC-- 0702	TC060 M2,5x5,5	T8
K170	●	S12K SD-CR 07	16	12	125	25	9	11	0,122			
K173	●	S16Q SD-CR 07	20	16	180	35	12	15	0,280	DC--11T3	TC067 M3,5x8,5	T15
K172	●	S16Q SD-CR 11	23	16	180	32	14	15	0,288			
K174	●	S20Q SD-CR 11	25	20	180	35	15	18	0,443			
K176	●	S25R SD-CR 11	32	25	200	45	17	23	0,771			
K178	●	S32T SD-CR 11	40	32	300	55	23	30	1,865			



5° SDZCR

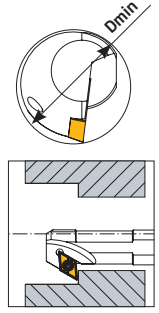
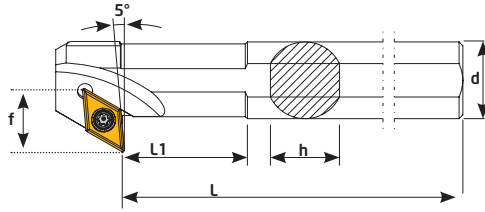
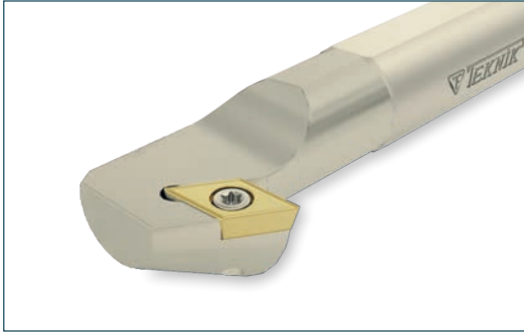

Sipariş Kodu Order Code Best.-Nr.	Stok/Stok/Lager	Ürün Kodu Product Code Produkt-Code	Ölçüler (mm) Dimensions(mm) Abmessungen (mm)							Kullanılan Uç Insert WSP	Sıkma Civatası Clamp Screw Torx-Schraube	Anahtar Torx Key Torx-Schlüssel
			Dmin	d	L	L1	f	h	kg			
K190	●	S12K SDZCR 07	18	12	125	20	11	11	0,128	DC--0702	TC060 M2,5x5,5	T8
K192	●	S16Q SDZCR 11	23	16	180	25	14	15	0,302			
K194	●	S20Q SDZCR 11	30	20	180	32	19	18	0,498			
K196	●	S25R SDZCR 11	35	25	200	32	22	23	0,816			

60° ST-CR

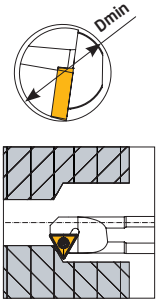
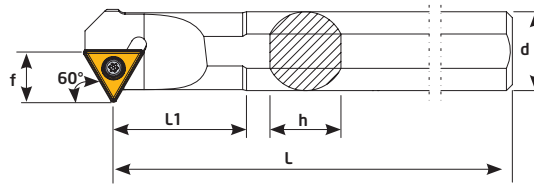

Sipariş Kodu Order Code Best.-Nr.	Stok/Stok/Lager	Ürün Kodu Product Code Produkt-Code	Ölçüler (mm) Dimensions(mm) Abmessungen (mm)							Kullanılan Uç Insert WSP	Sıkma Civatası Clamp Screw Torx-Schraube	Anahtar Torx Key Torx-Schlüssel
			Dmin	d	L	L1	f	h	kg			
K180	●	S16Q ST-CR 16	20	16	180	40	11	15	0,817	TC--16T3	TC067 M3,5x8,5	T15
K182	●	S20Q ST-CR 16	25	20	180	40	13	18	0,432			
K183	●	S25R ST-CR 16	32	25	200	50	17	23	0,772			
K183-1	●	S32T ST-CR 16	30	32	300	60	22	30	1,961			

● Stokta/In Stock/Lager ○ Sınırlı Stok/Limited Stock/Begrenzte Lagerhaltung

Kalite için Teknik Çözüm | Technical Solution For Quality

BROTECH

TEKNİK
Cutting Tools

www.teknikcuttingtools.com

203

90° STFCR IC

İçten Soğutmalı İç Çap Kater Boring Bars With Coolant

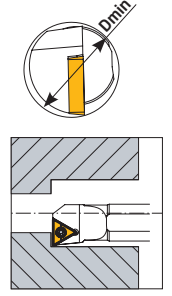
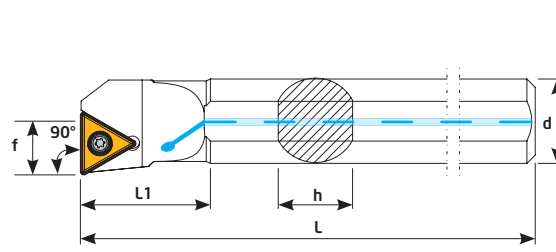

Sipariş Kodu Order Code Best.-Nr.	Stok/Stock/Lager	Ürün Kodu Product Code Produkt-Code	Ölçüler (mm) Dimensions(mm) Abmessungen (mm)							Kullanılan Uç Insert WSP	Sıkma Civatası Clamp Screw Torx-Schraube	Anahtar Torx Key Torx-Schlüssel
			Dmin	d	L	L1	f	h	kg			
KA160	●	A12K STFCR 11	16	12	125	25	9	11	0,053	TCMT 1102	TC060 M2,5x5,5	T8
KA161	●	A16Q STFCR 11	20	16	180	30	11	15	0,289			
KA162	●	A16Q STFCR 16	20	16	180	30	11	15	0,287	TCMT 16T3	TC067 M3,5x8,5	T15
KA164	●	A20Q STFCR 16	25	20	180	32	13	18	0,440			
KA166	●	A25R STFCR 16	32	25	200	40	16	23	0,754			

90° STFCR

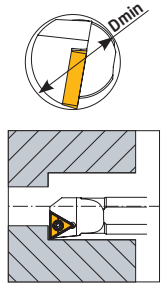
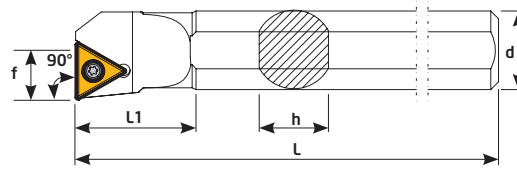
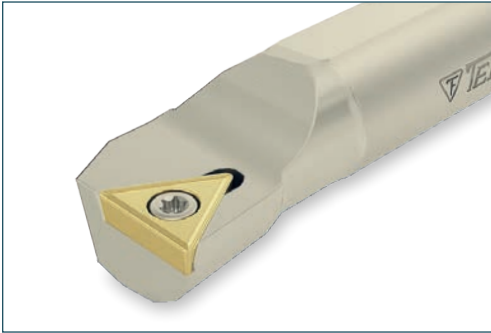

Sipariş Kodu Order Code Best.-Nr.	Stok/Stock/Lager	Ürün Kodu Product Code Produkt-Code	Ölçüler (mm) Dimensions(mm) Abmessungen (mm)							Kullanılan Uç Insert WSP	Sıkma Civatası Clamp Screw Torx-Schraube	Anahtar Torx Key Torx-Schlüssel
			Dmin	d	L	L1	f	h	kg			
K160	●	S12K STFCR 11	16	12	125	25	9	11	0,118	TCMT 1102	TC060 M2,5x5,5	T8
K161	●	S16Q STFCR 11	20	16	180	30	11	15	0,290			
K162	●	S16Q STFCR 16	20	16	180	30	11	15	0,287	TCMT 16T3	TC067 M3,5x8,5	T15
K164	●	S20Q STFCR 16	25	20	180	32	13	18	0,440			
K166	●	S25R STFCR 16	32	25	200	40	16	23	0,773			



90° STFCL IC

İçten Soğutmalı İç Çap Kater Boring Bars With Coolant

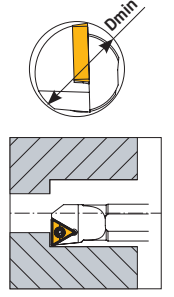
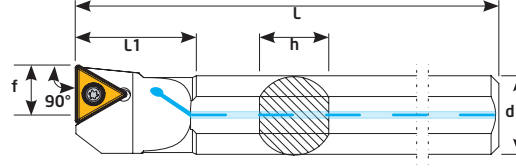

Sipariş Kodu Order Code Best.-Nr.	Stok/Stock/Lager	Ürün Kodu Product Code Produkt-Code	Ölçüler (mm) Dimensions(mm) Abmessungen (mm)							Kullanılan Uç Insert WSP	Sıkma Civatası Clamp Screw Torx-Schraube	Anahtar Torx Key Torx-Schlüssel
			Dmin	d	L	L1	f	h	kg			
KA184	●	A12K STFCL 11	16	12	125	25	9	11	0,053	TCMT 1102	TC060 M2,5x5,5	T8
KA185	●	A16Q STFCL 11	20	16	180	30	11	15	0,289			
KA186	●	A16Q STFCL 16	20	16	180	30	11	15	0,287	TCMT 16T3	TC067 M3,5x8,5	T15
KA187	●	A20Q STFCL 16	25	20	180	32	13	18	0,440			
KA188	●	A25R STFCL 16	32	25	200	40	16	23	0,754			

90° STFCL

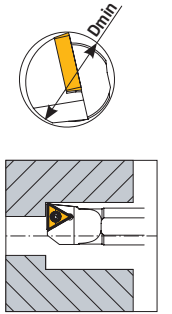
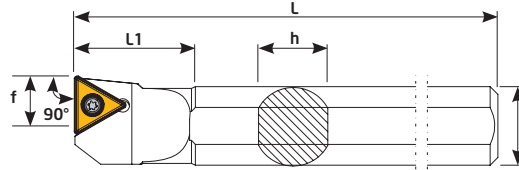

Sipariş Kodu Order Code Best.-Nr.	Stok/Stock/Lager	Ürün Kodu Product Code Produkt-Code	Ölçüler (mm) Dimensions(mm) Abmessungen (mm)							Kullanılan Uç Insert WSP	Sıkma Civatası Clamp Screw Torx-Schraube	Anahtar Torx Key Torx-Schlüssel
			Dmin	d	L	L1	f	h	kg			
K184	●	S12K STFCL 11	16	12	125	25	9	11	0,118	TCMT 1102	TC060 M2,5x5,5	T8
K185	●	S16Q STFCL 11	20	16	180	30	11	15	0,290			
K186	●	S16Q STFCL 16	20	16	180	30	11	15	0,287	TCMT 16T3	TC067 M3,5x8,5	T15
K187	●	S20Q STFCL 16	25	20	180	32	13	18	0,440			
K188	●	S25R STFCL 16	32	25	200	40	16	23	0,773			

93° SVUBR IC



İçten Soğutmalı İç Çap Kater Boring Bars With Coolant

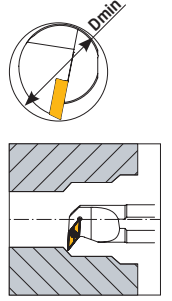
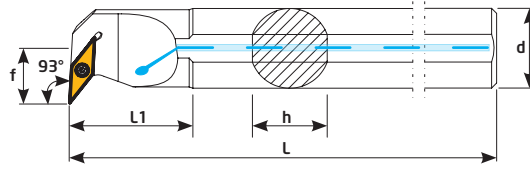

Sipariş Kodu Order Code Best.-Nr.	Stok/Stock/Lager	Ürün Kodu Product Code Produkt-Code	Ölçüler (mm) Dimensions(mm) Abmessungen (mm)							Kullanılan Uç Insert WSP	Sıkma Civatası Clamp Screw Torx-Schraube	Anahtar Torx Key Torx-Schlüssel
			Dmin	d	L	L1	f	h	kg			
KA208	●	A25R SVUBR 16	32	25	200	40	17	23	0,723	VBMT 1604	TC074 M4x10	T15
KA209	●	A32T SVUBR 16	40	32	300	50	22	30	1,909			

93° SVUBR

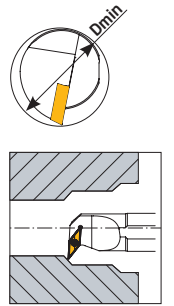
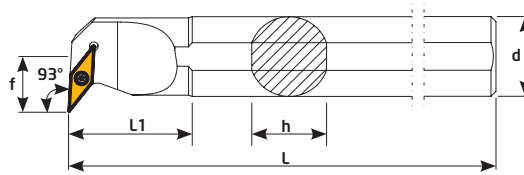
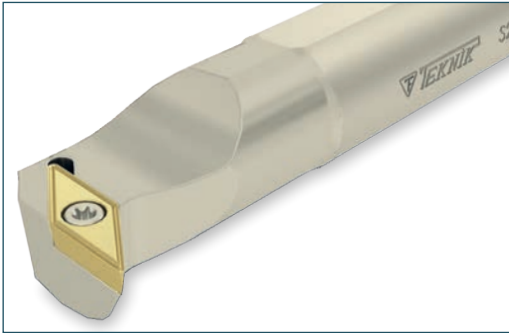

Sipariş Kodu Order Code Best.-Nr.	Stok/Stock/Lager	Ürün Kodu Product Code Produkt-Code	Ölçüler (mm) Dimensions(mm) Abmessungen (mm)							Kullanılan Uç Insert WSP	Sıkma Civatası Clamp Screw Torx-Schraube	Anahtar Torx Key Torx-Schlüssel
			Dmin	d	L	L1	f	h	kg			
K206	●	S16Q SVUBR 11	20	16	180	30	11	15	0,278	VBMT1103	TC061 M2,5x6,5	T8
K207	●	S20Q SVUBR 11	25	20	180	32	13	18	0,700			
K208	●	S25R SVUBR 16	32	25	200	40	17	23	0,730	VBMT 1604	TC074 M4x10	T15
K209	●	S32T SVUBR 16	40	32	300	50	22	30	1,822			
K210	●	S40T SVUBR 16	50	40	300	50	27	38	2,836			



93° SVUBL IC

İçten Soğutmalı İç Çap Kater Boring Bars With Coolant

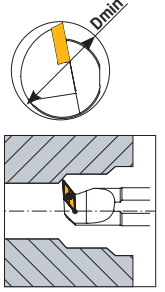
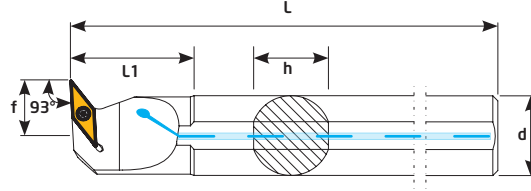

Sipariş Kodu Order Code Best.-Nr.	Stok/Stock/Lager	Ürün Kodu Product Code Produkt-Code	Ölçüler (mm) Dimensions(mm) Abmessungen (mm)							Kullanılan Uç Insert WSP	Sıkma Cıvatası Clamp Screw Torx-Schraube	Anahtar Torx Key Torx-Schlüssel
			Dmin	d	L	L1	f	h	ISO			
KA286	●	A25R SVUBL 16	32	25	200	40	17	23	0,723	VBMT 1604	TC074 M4x10	T15
KA288	●	A32T SVUBL 16	40	32	300	50	22	30	1,909			

93° SVUBL

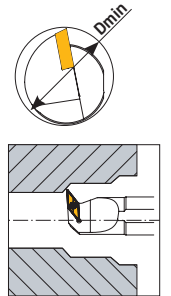
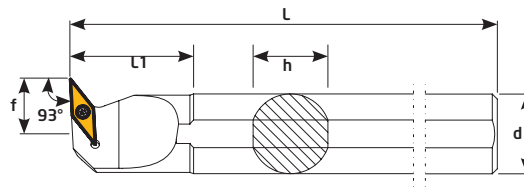
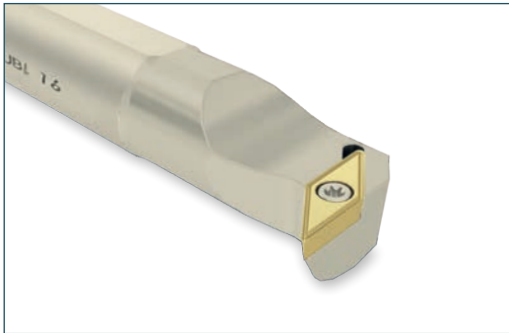

Sipariş Kodu Order Code Best.-Nr.	Stok/Stock/Lager	Ürün Kodu Product Code Produkt-Code	Ölçüler (mm) Dimensions(mm) Abmessungen (mm)							Kullanılan Uç Insert WSP	Sıkma Cıvatası Clamp Screw Torx-Schraube	Anahtar Torx Key Torx-Schlüssel
			Dmin	d	L	L1	f	h	ISO			
K282	●	S16Q SVUBL 11	20	16	180	30	11	15	0,278	VBMT 1103	TC061 M2,5x6,5	T8
K284	●	S20Q SVUBL 11	25	20	180	32	13	18	0,700			
K286	●	S25R SVUBL 16	32	25	200	40	17	23	0,730	VBMT 1604	TC074 M4x10	T15
K288	●	S32T SVUBL 16	40	32	300	50	22	30	1,822			

93° SVUCR IC

İçten Soğutmalı İç Çap Kater Boring Bars With Coolant

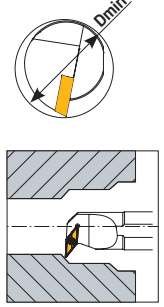
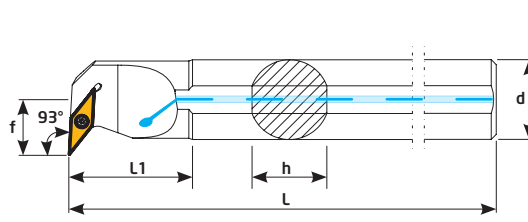

Sipariş Kodu Order Code Best.-Nr.	Stok/Stock/Lager	Ürün Kodu Product Code Produkt-Code	Ölçüler (mm) Dimensions(mm) Abmessungen (mm)							Kullanılan Uç Insert WSP	Sıkma Cıvatası Clamp Screw Torx-Schraube	Anahtar Torx Key Torx-Schlüssel
			Dmin	d	L	L1	f	h	KG			
KA211	●	A16Q SVUCR 11	20	16	180	30	11	15	0,268	VCMT 1103	TC061 M2,5x6,5	T8
KA212	●	A20Q SVUCR 11	25	20	180	32	13	18	0,689			
KA213	●	A25R SVUCR 16	32	25	200	40	17	23	0,720	VCMT 1604	TC074 M4x10	T15
KA214	●	A32T SVUCR 16	40	32	300	50	22	30	1,812			

93° SVUCR

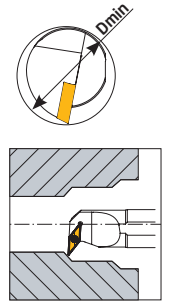
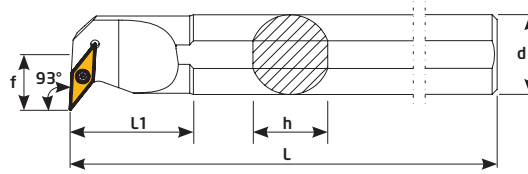

Sipariş Kodu Order Code Best.-Nr.	Stok/Stock/Lager	Ürün Kodu Product Code Produkt-Code	Ölçüler (mm) Dimensions(mm) Abmessungen (mm)							Kullanılan Uç Insert WSP	Sıkma Cıvatası Clamp Screw Torx-Schraube	Anahtar Torx Key Torx-Schlüssel
			Dmin	d	L	L1	f	h	KG			
K211	●	S16Q SVUCR 11	20	16	180	30	11	15	0,280	VCMT 1103	TC061 M2,5x6,5	T8
K212	●	S20Q SVUCR 11	25	20	180	32	13	18	0,432			
K213	●	S25R SVUCR 16	32	25	200	40	17	23	0,771	VCMT 1604	TC074 M4x10	T15
K214	●	S32T SVUCR 16	40	32	300	50	22	30	1,833			
K215	○	S40T SVUCR 16	50	40	300	55	27	38	2,807			



93° SVUCL IC

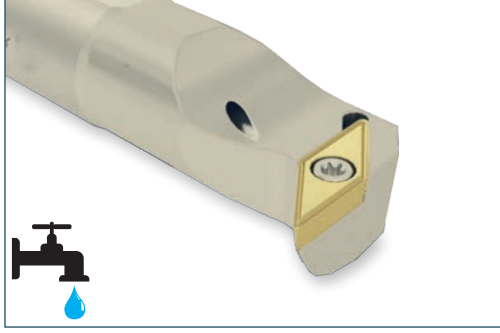

İçten Soğutmalı İç Çap Kater Boring Bars With Coolant

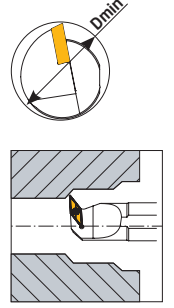
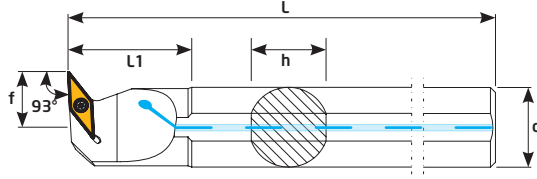

Sipariş Kodu Order Code Best.-Nr.	Stok/Stock/Lager	Ürün Kodu Product Code Produkt-Code	Ölçüler (mm) Dimensions(mm) Abmessungen (mm)							Kullanılan Uç Insert WSP	Sıkma Civatası Clamp Screw Torx-Schraube	Anahtar Torx Key Torx-Schlüssel
			Dmin	d	L	L1	f	h	kg			
KA300	●	A16Q SVUCL 11	20	16	180	30	11	15	0,268	VCMT 1103	TC061 M2,5x6,5	T8
KA302	●	A20Q SVUCL 11	25	20	180	32	13	18	0,689			
KA304	●	A25R SVUCL 16	32	25	200	40	17	23	0,720	VCMT 1604	TC074 M4x10	T15
KA306	●	A32T SVUCL 16	40	32	300	50	22	30	1,812			

93° SVUCL

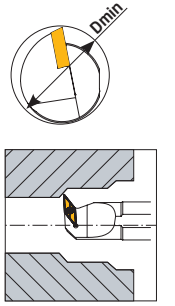
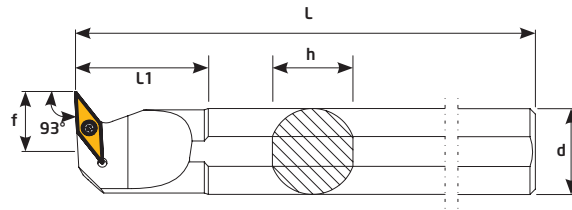
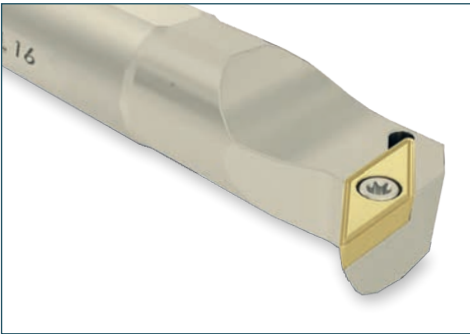

Sipariş Kodu Order Code Best.-Nr.	Stok/Stock/Lager	Ürün Kodu Product Code Produkt-Code	Ölçüler (mm) Dimensions(mm) Abmessungen (mm)							Kullanılan Uç Insert WSP	Sıkma Civatası Clamp Screw Torx-Schraube	Anahtar Torx Key Torx-Schlüssel
			Dmin	d	L	L1	f	h	kg			
K300	●	S16Q SVUCL 11	20	16	180	30	11	15	0,280	VCMT1103	TC061 M2,5x6,5	T8
K302	●	S20Q SVUCL 11	25	20	180	32	13	18	0,432			
K304	●	S25R SVUCL 16	32	25	200	40	17	23	0,771	VCMT1604	TC074 M4x10	T15
K306	○	S32T SVUCL 16	40	32	300	50	22	30	1,833			

● Stokta/ In Stock/ Lager ○ Sınırlı Stok/ Limited Stock/ Begrenzte Lagerhaltung

Kalite için Teknik Çözüm | Technical Solution For Quality

BROTECH

TEKNİK
Cutting Tools

www.teknikcuttingtools.com

209

107,5° SVQCR IC



İçten Soğutmalı İç Çap Kater Boring Bars With Coolant

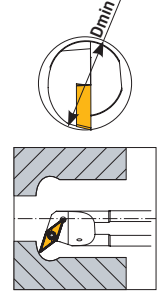
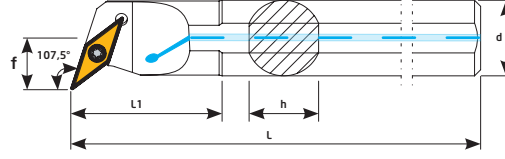

Sipariş Kodu Order Code Best.-Nr.	Stok/Stock/Lager	Ürün Kodu Product Code Produkt-Code	Ölçüler (mm) Dimensions(mm) Abmessungen (mm)							Kullanılan Uç Insert WSP	Sıkma Civatası Clamp Screw Torx-Schraube	Anahtar Torx Key Torx-Schlüssel
			Dmin	d	L	L1	f	h	KG			
KA221	●	A16Q SVQCR 11	20	16	180	30	11	15	0,271	VCMT 1103	TC061 M2,5x6,5	T8
KA222	●	A20Q SVQCR 11	25	20	180	30	13	18	1,752			

107,5° SVQCR

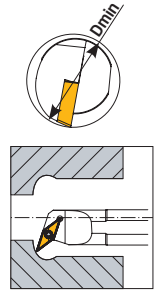
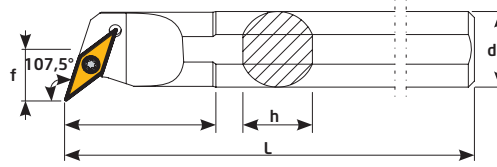

Sipariş Kodu Order Code Best.-Nr.	Stok/Stock/Lager	Ürün Kodu Product Code Produkt-Code	Ölçüler (mm) Dimensions(mm) Abmessungen (mm)							Kullanılan Uç Insert WSP	Sıkma Civatası Clamp Screw Torx-Schraube	Anahtar Torx Key Torx-Schlüssel
			Dmin	d	L	L1	f	h	KG			
K221	●	S16Q SVQCR 11	20	16	180	30	11	15	0,281	VCMT 1103	TC061 M2,5x6,5	T8
K222	●	S20Q SVQCR 11	25	20	180	30	13	18	1,762			
K223	●	S25R SVQCR 16	32	25	200	50	17	23	0,728	VCMT 1604	TC074 M4x10	T15
K224	●	S32T SVQCR 16	40	32	300	50	22	30	1,786			
K225	●	S40T SVQCR 16	50	40	300	55	27	38	2,767			



107,5° SVQCL IC

İçten Soğutmalı İç Çap Kater Boring Bars With Coolant

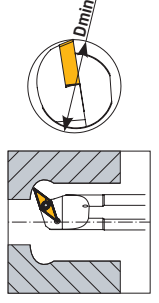
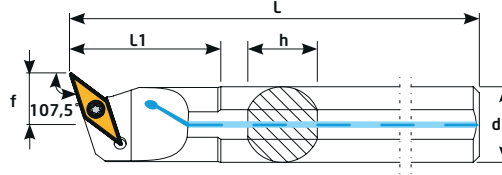

Sipariş Kodu Order Code Best.-Nr.	Stok/Stock/Lager	Ürün Kodu Product Code Produkt-Code	Ölçüler (mm) Dimensions(mm) Abmessungen (mm)							Kullanılan Uç Insert WSP	Sıkma Civatası Clamp Screw Torx-Schraube	Anahtar Torx Key Torx-Schlüssel
			Dmin	d	L	L1	f	h	KG			
KA319	●	A16Q SVQCL 11	20	16	180	30	11	15	0,271	VCMT 1103	TC061 M2,5x6,5	T8
KA320	●	A20Q SVQCL 11	25	20	180	30	13	18	1,752			

107,5° SVQCL

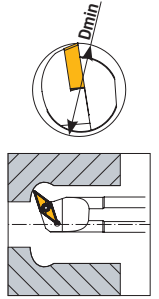
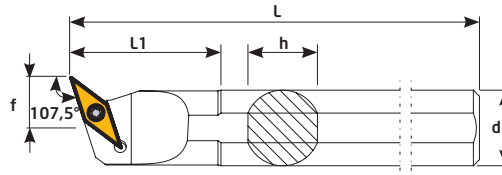
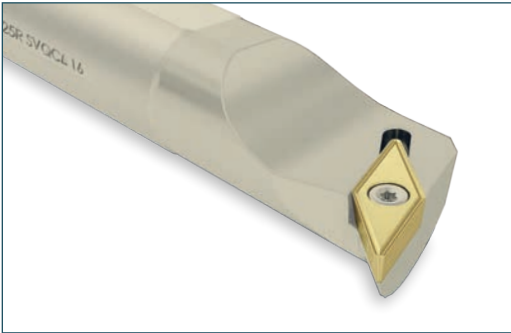

Sipariş Kodu Order Code Best.-Nr.	Stok/Stock/Lager	Ürün Kodu Product Code Produkt-Code	Ölçüler (mm) Dimensions(mm) Abmessungen (mm)							Kullanılan Uç Insert WSP	Sıkma Civatası Clamp Screw Torx-Schraube	Anahtar Torx Key Torx-Schlüssel
			Dmin	d	L	L1	f	h	KG			
K319	●	S16Q SVQCL 11	20	16	180	30	11	15	0,281	VCMT 1103	TC061 M2,5x6,5	T8
K320	●	S20Q SVQCL 11	25	20	180	30	13	18	1,762			
K322	●	S25R SVQCL 16	32	25	200	50	17	23	0,728	VCMT 1604	TC074 M4x10	T15
K324	●	S32T SVQCL 16	40	32	300	50	22	30	1,786			

● Stokta/In Stock/Lager ○ Sınırlı Stok/Limited Stock/Begrenzte Lagerhaltung

Kalite için Teknik Çözüm | Technical Solution For Quality



www.teknikcuttingtools.com

107,5° SVQBR

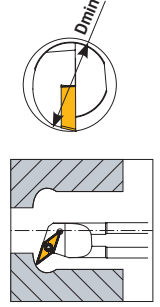
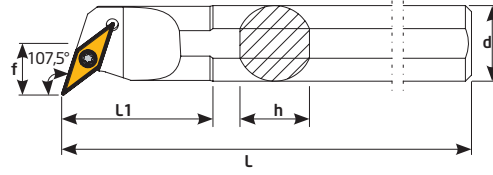

Sipariş Kodu Order Code Best.-Nr.	Stok/Stock/Lager	Ürün Kodu Product Code Produkt-Code	Ölçüler (mm) Dimensions(mm) Abmessungen (mm)							Kullanılan Uç Insert WSP	Sıkma Civatası Clamp Screw Torx-Schraube	Anahtar Torx Key Torx-Schlüssel
			Dmin	d	L	L1	f	h	Ⓢ			
K216	●	S16Q SVQBR 11	20	16	180	30	11	15	0,276	VBMT 1103	TC061 M2,5x6,5	T8
K217	●	S20Q SVQBR 11	25	20	180	30	13	18	0,422			
K218	●	S25R SVQBR 16	32	25	200	50	17	23	0,725	VBMT 1604	TC074 M4x10	T15
K219	●	S32T SVQBR 16	40	32	300	50	22	30	1,790			
K220	●	S40T SVQBR 16	50	40	300	55	27	38	2,765			

107,5° SVQBL

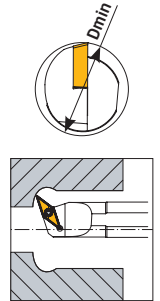
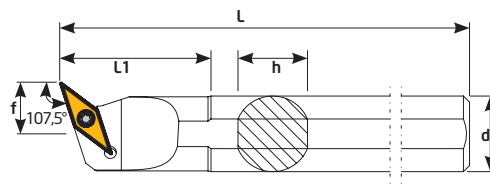

Sipariş Kodu Order Code Best.-Nr.	Stok/Stock/Lager	Ürün Kodu Product Code Produkt-Code	Ölçüler (mm) Dimensions(mm) Abmessungen (mm)							Kullanılan Uç Insert WSP	Sıkma Civatası Clamp Screw Torx-Schraube	Anahtar Torx Key Torx-Schlüssel
			Dmin	d	L	L1	f	h	Ⓢ			
K310	●	S16Q SVQBL 11	20	16	180	30	11	15	0,276	VBMT 1103	TC061 M2,5x6,5	T8
K312	●	S20Q SVQBL 11	25	20	180	30	13	18	0,422			
K314	●	S25R SVQBL 16	32	25	200	50	17	23	0,725	VBMT 1604	TC074 M4x10	T15
K316	●	S32T SVQBL 16	40	32	300	50	22	30	1,790			
K318	●	S40T SVQBL 16	50	40	300	55	27	38	2,765			





Karbür iç Çap Kater / Set
Carbide Boring Bars / Set
VHM Bohrstange / Set





**Technical Solution
for Quality**





E-SCLCR SET

Sipariş Kodu Order Code Best.-Nr.	Setteki Ürün Kodları Product Code In Set Produkt-Code in Set	Ölçüler (mm) Dimensions(mm) Abmessungen (mm)						kg	Kullanılan Uç Insert WSP	Sıkma Civatası Clamp Screw Torx-Schraube	Anahtar Torx Key Torx-Schlüssel
		Dmin	d	L	f	h					
İPS30	E08K SCLCR 06	10	8	125	5	7,5	0,350				
	E10K SCLCR 06	12	10	125	6	9,5					
	E12M SCLCR 06	16	12	150	7	11,5					

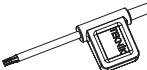

E-SCLCL SET

Sipariş Kodu Order Code Best.-Nr.	Setteki Ürün Kodları Product Code In Set Produkt-Code in Set	Ölçüler (mm) Dimensions(mm) Abmessungen (mm)						kg	Kullanılan Uç Insert WSP	Sıkma Civatası Clamp Screw Torx-Schraube	Anahtar Torx Key Torx-Schlüssel
		Dmin	d	L	f	h					
İPS31	E08K SCLCL 06	10	8	125	5	7,5	0,350				
	E10K SCLCL 06	12	10	125	6	9,5					
	E12M SCLCL 06	16	12	150	7	11,5					

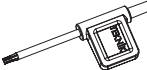

E-SDUCR SET

Sipariş Kodu Order Code Best.-Nr.	Setteki Ürün Kodları Product Code In Set Produkt-Code in Set	Ölçüler (mm) Dimensions(mm) Abmessungen (mm)						kg	Kullanılan Uç Insert WSP	Sıkma Civatası Clamp Screw Torx-Schraube	Anahtar Torx Key Torx-Schlüssel
		Dmin	d	L	f	h					
İPS32	E10K SDUCR 07	13	10	125	7	9,5	0,150				
	E12M SDUCR 07	16	12	150	9	11,5					

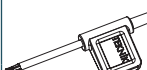

E-SDUCL SET

Sipariş Kodu Order Code Best.-Nr.	Setteki Ürün Kodları Product Code In Set Produkt-Code in Set	Ölçüler (mm) Dimensions(mm) Abmessungen (mm)						kg	Kullanılan Uç Insert WSP	Sıkma Civatası Clamp Screw Torx-Schraube	Anahtar Torx Key Torx-Schlüssel
		Dmin	d	L	f	h					
İPS33	E10K SDUCL 07	13	10	125	7	9,5	0,150				
	E12M SDUCL 07	16	12	150	9	11,5					

E-SDQCR SET

Sipariş Kodu Order Code Best.-Nr.	Setteki Ürün Kodları Product Code In Set Produkt-Code in Set	Ölçüler (mm) Dimensions(mm) Abmessungen (mm)						kg	Kullanılan Uç Insert WSP	Sıkma Civatası Clamp Screw Torx-Schraube	Anahtar Torx Key Torx-Schlüssel
		Dmin	d	L	f	h					
İPS34	E10K SDQCR 07	13	10	125	7	9,5	0,150				
	E12M SDQCR 07	16	12	150	9	11,5					

E-SDQCL SET

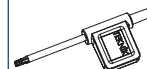
Sipariş Kodu Order Code Best.-Nr.	Setteki Ürün Kodları Product Code In Set Produkt-Code in Set	Ölçüler (mm) Dimensions(mm) Abmessungen (mm)						kg	Kullanılan Uç Insert WSP	Sıkma Civatası Clamp Screw Torx-Schraube	Anahtar Torx Key Torx-Schlüssel
		Dmin	d	L	f	h					
İPS35	E10K SDQCL 07	13	10	125	7	9,5	0,150				
	E12M SDQCL 07	16	12	150	9	11,5					



95° E-SCLCR IC

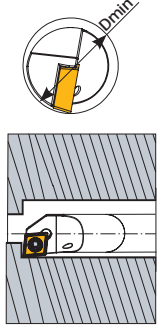
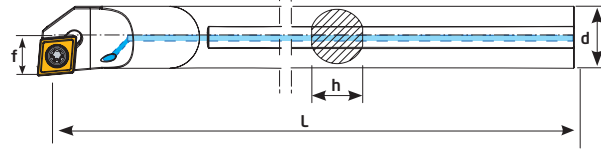
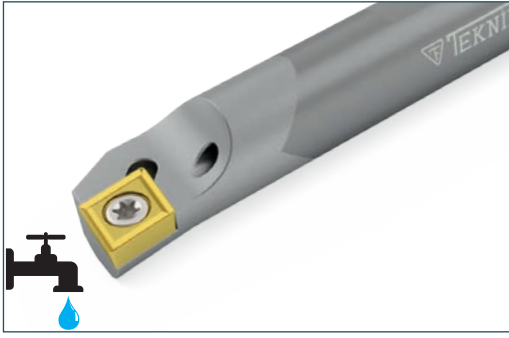

Sipariş Kodu Order Code Best.-Nr.	Stok/Stock/Lager	Ürün Kodu Product Code Produkt-Code	Ölçüler (mm) Dimensions(mm) Abmessungen (mm)						Kullanılan Uç Insert WSP	Sıkma Civatası Clamp Screw Torx-Schraube	Anahtar Torx Key Torx-Schlüssel
			Dmin	d	L	f	h	KG			
KE10	●	E08K SCLCR 06	10	8	125	5	7,5	0,050	CC-- 0602	TC060 M2,5x5,5	T8
KE11	●	E10K SCLCR 06	12	10	125	6	9,5	0,100			
KE12	●	E12M SCLCR 06	16	12	150	7	11,5	0,200			
KE13	●	E16R SCLCR 09	20	16	200	10	15,5	0,500	CCMT 09T3	TC067 M3,5x8,5	T15
KE14	●	E20S SCLCR 09	25	20	250	13	19,5	0,950			

95° E-SCLCL IC

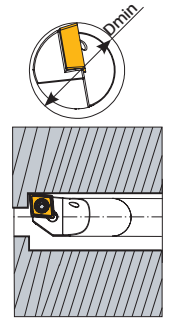
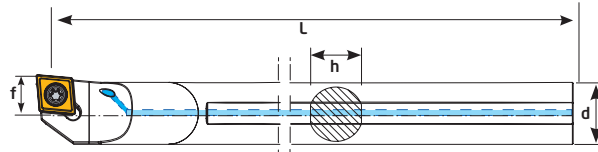
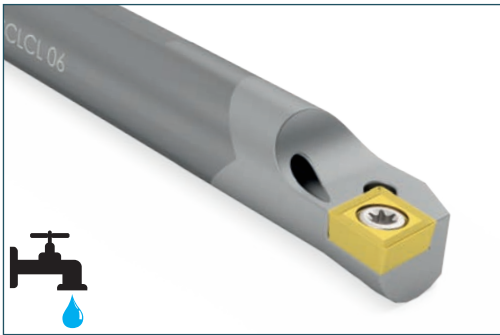

Sipariş Kodu Order Code Best.-Nr.	Stok/Stock/Lager	Ürün Kodu Product Code Produkt-Code	Ölçüler (mm) Dimensions(mm) Abmessungen (mm)						Kullanılan Uç Insert WSP	Sıkma Civatası Clamp Screw Torx-Schraube	Anahtar Torx Key Torx-Schlüssel
			Dmin	d	L	f	h	KG			
KE17	●	E08K SCLCL 06	10	8	125	5	7,5	0,050	CC-- 0602	TC060 M2,5x5,5	T8
KE18	●	E10K SCLCL 06	12	10	125	6	9,5	0,100			
KE19	●	E12M SCLCL 06	16	12	150	7	11,5	0,200			
KE20	●	E16R SCLCL 09	20	16	200	10	15,5	0,500	CCMT 09T3	TC067 M3,5x8,5	T15
KE21	●	E20S SCLCL 09	25	20	250	13	19,5	0,950			

● Stokta/ In Stock/ Lager ○ Sınırlı Stok/ Limited Stock/ Begrenzte Lagerhaltung

Kalite için Teknik Çözüm | Technical Solution For Quality

BROTECH

TEKNIK
Cutting Tools

www.teknikcuttingtools.com

215

93° E-SDUCR IC

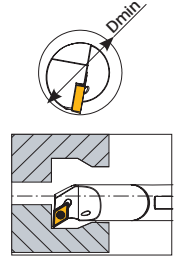
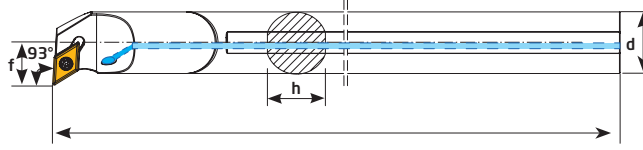

Sipariş Kodu Order Code Best.-Nr.	Stok/Stock/Lager	Ürün Kodu Product Code Produkt-Code	Ölçüler (mm) Dimensions(mm) Abmessungen (mm)						Kullanılan Uç Insert WSP	Sıkma Civatası Clamp Screw Torx-Schraube	Anahtar Torx Key Torx-Schlüssel
			Dmin	d	L	f	h	KG			
KE30	●	E10K SDUCR 07	13	10	125	7	9,5	0,050	DCMT 0702	TC060 M2,5x5,5	T8
KE31	●	E12M SDUCR 07	16	12	150	9	11,5	0,100			
KE32	●	E16R SDUCR 07	20	16	200	11	15,5	0,200			
KE33	●	E16R SDUCR 11	20	16	200	11	15,5	0,500	DCMT 11T3	TC067 M3,5x8,5	T15
KE34	●	E20S SDUCR 11	25	20	250	13	19,5	0,950			

93° E-SDUCL IC

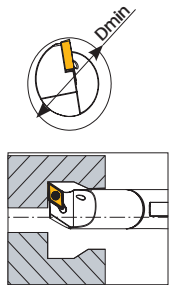
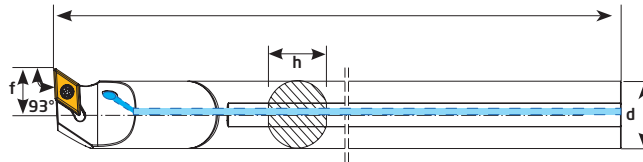
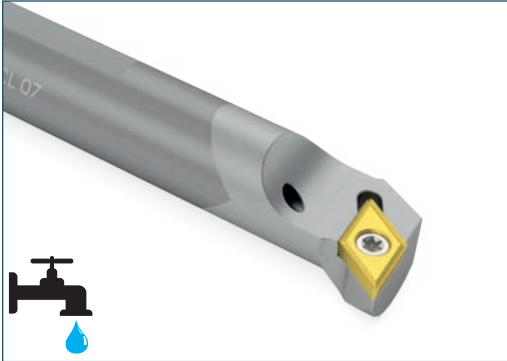

Sipariş Kodu Order Code Best.-Nr.	Stok/Stock/Lager	Ürün Kodu Product Code Produkt-Code	Ölçüler (mm) Dimensions(mm) Abmessungen (mm)						Kullanılan Uç Insert WSP	Sıkma Civatası Clamp Screw Torx-Schraube	Anahtar Torx Key Torx-Schlüssel
			Dmin	d	L	f	h	KG			
KE40	●	E10K SDUCL 07	13	10	125	7	9,5	0,050	DCMT 0702	TC060 M2,5x5,5	T8
KE41	●	E12M SDUCL 07	16	12	150	9	11,5	0,100			
KE42	●	E16R SDUCL 07	20	16	200	11	15,5	0,200			
KE43	●	E16R SDUCL 11	20	16	200	11	15,5	0,500	DCMT 11T3	TC067 M3,5x8,5	T15
KE44	●	E20S SDUCL 11	25	20	250	13	19,5	0,950			

● Stokta/In Stock/Lager ○ Sınırlı Stok/Limited Stock/Begrenzte Lagerhaltung



107,5° E-SDQCR IC

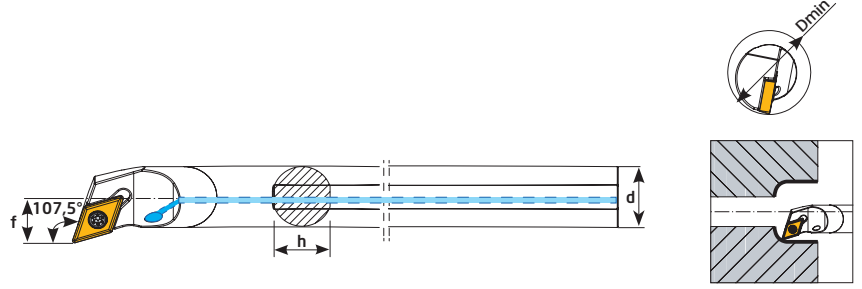

Sipariş Kodu Order Code Best.-Nr.	Stok/Stock/Lager	Ürün Kodu Product Code Produkt-Code	Ölçüler (mm) Dimensions(mm) Abmessungen (mm)						Kullanılan Uç Insert WSP	Sıkma Civatası Clamp Screw Torx-Schraube	Anahtar Torx Key Torx-Schlüssel
			Dmin	d	L	f	h	kg			
KE50	●	E10K SDQCR 07	13	10	125	7	9,5	0,050	DCMT 0702	TC060 M2,5x5,5	T8
KE51	●	E12M SDQCR 07	16	12	150	9	11,5	0,100			
KE52	●	E16R SDQCR 07	20	16	200	11	15,5	0,200			
KE53	●	E16R SDQCR 11	20	16	200	11	15,5	0,500	DCMT 11T3	TC067 M3,5x8,5	T15
KE54	●	E20S SDQCR 11	25	20	250	13	19,5	0,950			

107,5° E-SDQCL IC

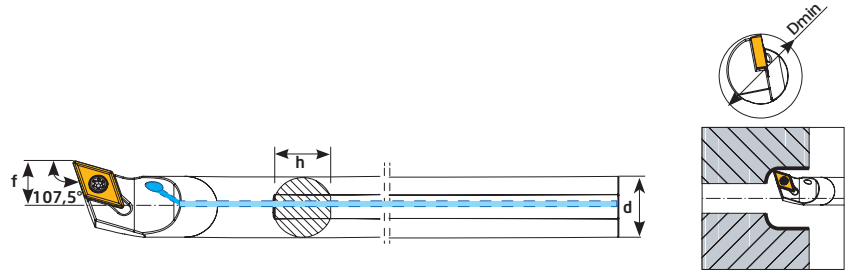
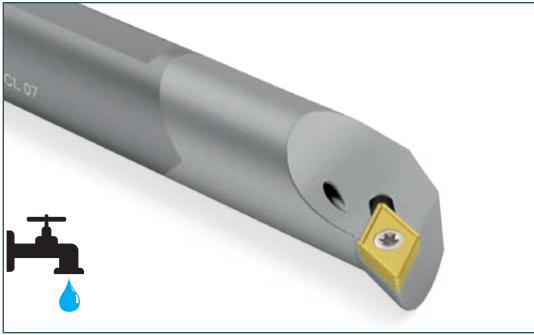

Sipariş Kodu Order Code Best.-Nr.	Stok/Stock/Lager	Ürün Kodu Product Code Produkt-Code	Ölçüler (mm) Dimensions(mm) Abmessungen (mm)						Kullanılan Uç Insert WSP	Sıkma Civatası Clamp Screw Torx-Schraube	Anahtar Torx Key Torx-Schlüssel
			Dmin	d	L	f	h	kg			
KE60	●	E10K SDQCL 07	13	10	125	7	9,5	0,050	DCMT 0702	TC060 M2,5x5,5	T8
KE61	●	E12M SDQCL 07	16	12	150	9	11,5	0,100			
KE62	●	E16R SDQCL 07	20	16	200	11	15,5	0,200			
KE63	●	E16R SDQCL 11	20	16	200	11	15,5	0,500	DCMT 11T3	TC067 M3,5x8,5	T15
KE64	●	E20S SDQCL 11	25	20	250	13	19,5	0,950			

● Stokta/In Stock/Lager ○ Sınırlı Stok/Limited Stock/Begrenzte Lagerhaltung

Kalite için Teknik Çözüm | Technical Solution For Quality

BROTECH

TEKNİK
Cutting Tools

www.teknikcuttingtools.com

217

Karbür İç Çap Diş Kateri IC
Carbide E System Internal Threading Toolholders IC

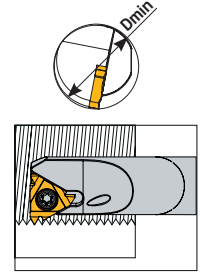
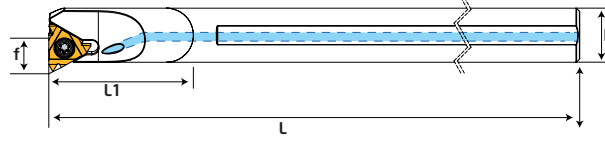

Sipariş Kodu Order Code Best.-Nr.	Stok/Stock/Lager	Ürün Kodu Product Code Produkt-Code	Ölçüler (mm) Dimensions(mm) Abmessungen (mm)					Delik Çapı	Kullanılan Uç Insert WSP	Sıkma Civatası Clamp Screw Torx-Schraube	Altlık Shim U-Platte	Pul Washer U-Scheibe	Altlık Civatası Shim Screw U-Platte Schraube	Anahtar Torx Key Torx-Schlüssel	
			D	L	L1	f	Dmin								
KE70	●	E06H - IR06	6	100	26	4,3	6	0,024	6 IR	TC58 M2x4,2					
KE71	●	E08K - IR08	8	125	31	5,3	7,8	0,045	8 IR	TC58-1 M2x4,6					T6
KE72	●	E10M - IR11	10	150	-	7,4	12	0,085	11 IR	TC060 M2,5x5,5	-	-	-	T8	
KE73	●	E12P - IR11	12	170	-	8,4	15	0,150							
KE74	●	E16R - IR16	16	200	-	11,7	19	0,260	16 IR	TC067 M3,5 x8,5	TA060	BSP10	TC062 M3	T15	
KE75	●	E20S - IR16	20	250	-	13,7	24	0,560		TC068 M3,5x11					
KE76	●	E25S - IR16	25	250	-	16,2	29	0,900							
KE78	●	E20S - IR22	20	250	-	15,6	24,5	0,570	22 IR	TC078 M4x11	-	-	-		

Karbür Diş Açma Frezeler / Carbide Thread IC
Cutting Cutter / Carbide Gewindeschneid Fräser IC

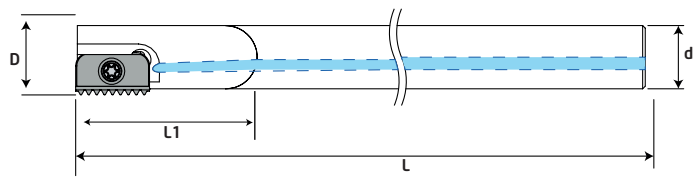

Sipariş Kodu Order Code Best.-Nr.	Stok/Stock/Lager	Ürün Kodu Product Code Produkt-Code	Ölçüler (mm) Dimensions(mm) Abmessungen (mm)					Kullanılan Uç Insert WSP	Sıkma Civatası Clamp Screw Torx-Schraube	Anahtar Torx Key Torx-Schlüssel	
			A	D	d	L	L1				
KE90	●	D9,9 d08 L125 A12 S12	12	9,9	8	125	-	0,049	S12	TC092 M2,5x5,5	T8
KE91	●	D13,2 d10 L110 A14 S14	14	13,2	10	110	-	0,067	S14	TC093 M2,5x7	
KE92	●	D13,2 d10 L155 A14 S14	14	13,2	10	155	-	0,100			
KE93	●	D15,2 d12 L175 A14 S14	14	15,2	12	175	-	0,167	S21	TC074 M4x10	T15
KE94	●	D21 d16 L130 A21 S21	21	21	16	130	-	0,212			
KE95	●	D21 d16 L200 A21 S21	21	21	16	200	-	0,327			

● Stokta/ In Stock/ Lager ○ Sınırlı Stok/ Limited Stock/ Begrenzte Lagerhaltung





İç Çap Kater Set
Boring Bars Set
Bohrstangen Set



**Technical Solution
for Quality**



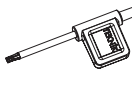

SCLCR SET IC

Sipariş Kodu Order Code Best.-Nr.	Setteki Ürün Kodları Product Code In Set Produkt-Code in Set	Ölçüler (mm) Dimensions(mm) Abmessungen (mm)						kg	Uç Insert WSP	Sıkma Cıvatası Clamp Screw Torx-Schraube	Anahtar Torx Key Torx-Schlüssel
		Dmin	d	L	L1	f	h				
İPS01	A08H SCLCR 06	10	8	100	16	5,5	7	0,464			
	A10J SCLCR 06	12	10	110	20	6	9				
	A12K SCLCR 06	16	12	125	25	9	11				
	A16M SCLCR 09	20	16	150	30	11	15				
									CC-- 0602	TC060 M2,5x5,5	T8
									CC-- 09T3	TC067 M3,5x8,5	T15



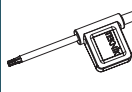

SCLCL SET IC



Sipariş Kodu Order Code Best.-Nr.	Setteki Ürün Kodları Product Code In Set Produkt-Code in Set	Ölçüler (mm) Dimensions(mm) Abmessungen (mm)						kg	Uç Insert WSP	Sıkma Cıvatası Clamp Screw Torx-Schraube	Anahtar Torx Key Torx-Schlüssel
		Dmin	d	L	L1	f	h				
İPS04	A08H SCLCL 06	10	8	100	16	5,5	7	0,464			
	A10J SCLCL 06	12	10	110	20	6	9				
	A12K SCLCL 06	16	12	125	25	9	11				
	A16M SCLCL 09	20	16	150	30	11	15				
									CC-- 0602	TC060 M2,5x5,5	T8
									CC-- 09T3	TC067 M3,5x8,5	T15



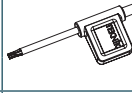

SDUCR SET IC

Sipariş Kodu Order Code Best.-Nr.	Setteki Ürün Kodları Product Code In Set Produkt-Code in Set	Ölçüler (mm) Dimensions(mm) Abmessungen (mm)						kg	Uç Insert WSP	Sıkma Cıvatası Clamp Screw Torx-Schraube	Anahtar Torx Key Torx-Schlüssel
		Dmin	d	L	L1	f	h				
İPS02	A10J SDUCR 07	12	10	110	20	7	9	0,450			
	A12K SDUCR 07	16	12	125	25	9	11				
	A16M SDUCR 07	20	16	150	30	11	15				
									DC--0702	TC060 M2,5x5,5	T8

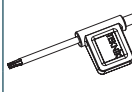

SDUCL SET IC

Sipariş Kodu Order Code Best.-Nr.	Setteki Ürün Kodları Product Code In Set Produkt-Code in Set	Ölçüler (mm) Dimensions(mm) Abmessungen (mm)						kg	Uç Insert WSP	Sıkma Cıvatası Clamp Screw Torx-Schraube	Anahtar Torx Key Torx-Schlüssel
		Dmin	d	L	L1	f	h				
İPS05	A10J SDUCL 07	12	10	110	20	7	9	0,450			
	A12K SDUCL 07	16	12	125	25	9	11				
	A16M SDUCL 07	20	16	150	30	11	15				
									DC--0702	TC060 M2,5x5,5	T8

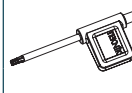
SDQCR SET IC

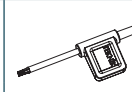

Sipariş Kodu Order Code Best.-Nr.	Setteki Ürün Kodları Product Code In Set Produkt-Code in Set	Ölçüler (mm) Dimensions(mm) Abmessungen (mm)						kg	Uç Insert WSP	Sıkma Cıvatası Clamp Screw Torx-Schraube	Anahtar Torx Key Torx-Schlüssel
		Dmin	d	L	L1	f	h				
İPS03	A10J SDQCR 07	12	10	110	20	7	9	0,434			
	A12K SDQCR 07	16	12	125	25	9	11				
	A16M SDQCR 07	20	16	150	30	11	15				
									DC--0702	TC060 M2,5x5,5	T8

SDQCL SET IC

Sipariş Kodu Order Code Best.-Nr.	Setteki Ürün Kodları Product Code In Set Produkt-Code in Set	Ölçüler (mm) Dimensions(mm) Abmessungen (mm)						kg	Uç Insert WSP	Sıkma Cıvatası Clamp Screw Torx-Schraube	Anahtar Torx Key Torx-Schlüssel
		Dmin	d	L	L1	f	h				
İPS06	A10J SDQCL 07	12	10	110	20	7	9	0,434			
	A12K SDQCL 07	16	12	125	25	9	11				
	A16M SDQCL 07	20	16	150	30	11	15				
									DC--0702	TC060 M2,5x5,5	T8



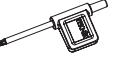

SCLCR SET



Sipariş Kodu Order Code Best.-Nr.	Setteki Ürün Kodları Product Code In Set Produkt-Code in Set	Ölçüler (mm) Dimensions(mm) Abmessungen (mm)						kg	Uç Insert WSP	Sıkma Cıvatası Clamp Screw Torx-Schraube	Anahtar Torx Key Torx-Schlüssel
		Dmin	d	L	L1	f	h				
İPS20	S08H SCLCR 06	10	8	100	16	5,5	7	0,960			
	S10J SCLCR 06	12	10	110	20	6	9				
	S12K SCLCR 06	16	12	125	25	9	11				
	S16M SCLCR 09	20	16	150	30	11	15				
									CC-- 0602	TC060 M2,5x5,5	T8
									CC-- 09T3	TC067 M3,5x8,5	T15

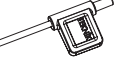

SCLCL SET

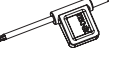

Sipariş Kodu Order Code Best.-Nr.	Setteki Ürün Kodları Product Code In Set Produkt-Code in Set	Ölçüler (mm) Dimensions(mm) Abmessungen (mm)						kg	Uç Insert WSP	Sıkma Cıvatası Clamp Screw Torx-Schraube	Anahtar Torx Key Torx-Schlüssel
		Dmin	d	L	L1	f	h				
İPS21	S08H SCLCL 06	10	8	100	16	5,5	7	0,960			
	S10J SCLCL 06	12	10	110	20	6	9				
	S12K SCLCL 06	16	12	125	25	9	11				
	S16M SCLCL 09	20	16	150	30	11	15				
									CC-- 0602	TC060 M2,5x5,5	T8
									CC-- 09T3	TC067 M3,5x8,5	T15

SDUCR SET



Sipariş Kodu Order Code Best.-Nr.	Setteki Ürün Kodları Product Code In Set Produkt-Code in Set	Ölçüler (mm) Dimensions(mm) Abmessungen (mm)						kg	Uç Insert WSP	Sıkma Cıvatası Clamp Screw Torx-Schraube	Anahtar Torx Key Torx-Schlüssel
		Dmin	d	L	L1	f	h				
İPS22	S10J SDUCR 07	12	10	110	20	7	9	0,446			
	S12K SDUCR 07	16	12	125	25	9	11				
	S16M SDUCR 11	20	16	150	30	11	15				
									DC--0702	TC060 M2,5x5,5	T8
									DC--11T3	TC067 M3,5x8,5	T15



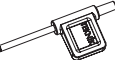

SDUCL SET

Sipariş Kodu Order Code Best.-Nr.	Setteki Ürün Kodları Product Code In Set Produkt-Code in Set	Ölçüler (mm) Dimensions(mm) Abmessungen (mm)						kg	Uç Insert WSP	Sıkma Cıvatası Clamp Screw Torx-Schraube	Anahtar Torx Key Torx-Schlüssel
		Dmin	d	L	L1	f	h				
İPS23	S10J SDUCL 07	12	10	110	20	7	9	0,446			
	S12K SDUCL 07	16	12	125	25	9	11				
	S16M SDUCL 11	20	16	150	30	11	15				
									DC--0702	TC060 M2,5x5,5	T8
									DC--11T3	TC067 M3,5x8,5	T15

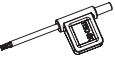
SDQCR SET

Sipariş Kodu Order Code Best.-Nr.	Setteki Ürün Kodları Product Code In Set Produkt-Code in Set	Ölçüler (mm) Dimensions(mm) Abmessungen (mm)						kg	Uç Insert WSP	Sıkma Cıvatası Clamp Screw Torx-Schraube	Anahtar Torx Key Torx-Schlüssel
		Dmin	d	L	L1	f	h				
İPS24	S10J SDQCR 07	12	10	110	20	7	9	0,442			
	S12K SDQCR 07	16	12	125	25	9	11				
	S16M SDQCR 11	20	16	150	30	11	15				
									DC--0702	TC060 M2,5x5,5	T8
									DC--11T3	TC067 M3,5x8,5	T15

SDQCL SET

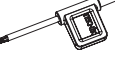
Sipariş Kodu Order Code Best.-Nr.	Setteki Ürün Kodları Product Code In Set Produkt-Code in Set	Ölçüler (mm) Dimensions(mm) Abmessungen (mm)						kg	Uç Insert WSP	Sıkma Cıvatası Clamp Screw Torx-Schraube	Anahtar Torx Key Torx-Schlüssel
		Dmin	d	L	L1	f	h				
İPS25	S10J SDQCL 07	12	10	110	20	7	9	0,442			
	S12K SDQCL 07	16	12	125	25	9	11				
	S16M SDQCL 11	20	16	150	30	11	15				
									DC--0702	TC060 M2,5x5,5	T8
									DC--11T3	TC067 M3,5x8,5	T15

● Stokta/ In Stock/ Lager ○ Sınırlı Stok/ Limited Stock/ Begrenzte Lagerhaltung

Kalite için Teknik Çözüm | Technical Solution For Quality



www.teknikcuttingtools.com

221



Uç Bağlama Sistemleri
Insert Clamping Systems
Wendeplatten klem systems

www.teknikcuttingtools.com



U-Drill
Indexable Insert Drills
Vollbohrer



**Technical Solution
for Quality**



**U-DRILL EKSANTRİK
ADAPTÖRÜ
ADAPTOR FOR U-DRILLS**

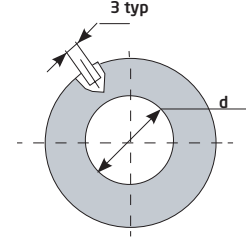
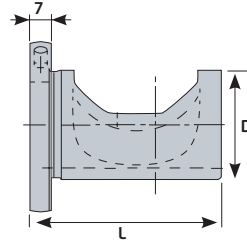

Adaptörün radyal olarak ayarlanmasını kolaylaştırmak için kullanılır.
(This pin used to ease radial adjustment of the sleeve.)

Sipariş Kodu Order Code Best.-Nr.	Stok/Stock/Lager	Ürün Kodu Product Code Produkt-Code	Ölçüler (mm) Dimensions(mm) Abmessungen (mm)		
			D	d	L
UA10	●	D25 d20 L46	25	20	46,5
UA12	●	D32 d25 L47	32	25	47
UA14	●	D40 d32 L57	40	32	57

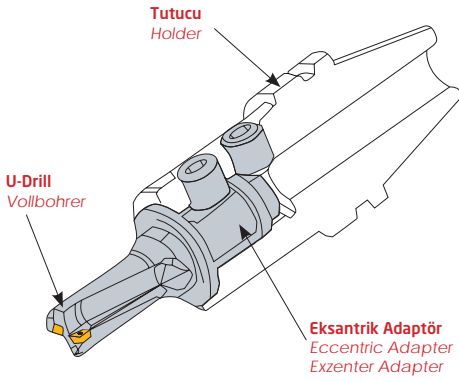

Frezeleme tezgahında takma uçlu matkabın nominal çapı, matkabın ekseninin, sipinde eksenine göre ötelenmesiyle değişebilir.

On a milling machine the drill's nominal diameter can be changed By shifting the drill's axis out of the tool spindle.

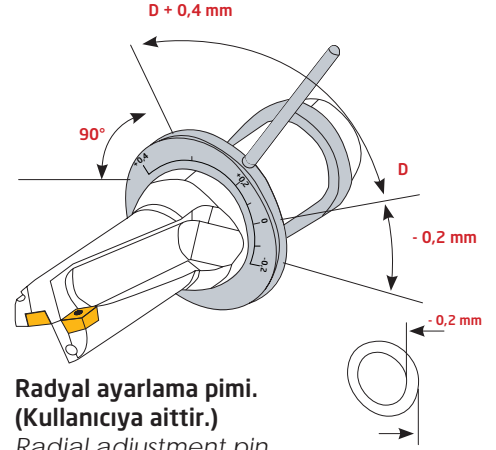
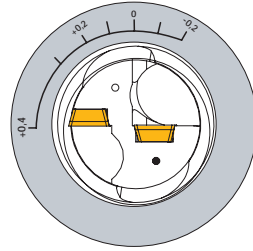

Radyal ayarlama pimi.
(Kullanıcıya aittir.)
Radial adjustment pin.
(not supplied)

Delik Çapı
Hole Diameter
24,8 mm



U-Drill Çapı
Drill Diameter
25 mm

Delik Çapı
Hole Diameter
25 mm



U-Drill Çapı
Drill Diameter
25 mm

Delik Çapı
Hole Diameter
25,4 mm



U-Drill Çapı
Drill Diameter
25 mm

U-Drill'in üzerindeki düz çizgi adaptörün sıfır rakamının üzerine konulmalıdır.

UA'nin (eksantrik adaptörün) çevrilmesini kolaylaştırmak için UA'nin üzerindeki deliğe, metal bir çubuk ya da vida anahtarları yerleştirilebilir. UA'yi ayarlamadan önce tutucunun vidasını hafifçe çözün.

The adjustment marking should be located perpendicular to the flat on the circumference of the U-DRILL flange. To facilitate the rotation of the adaptor, a metal rod or a screw key may be inserted into a hole on the exentric adaptor flange. Unlock adapter screw before adjusting adaptor.



D2 WCM_

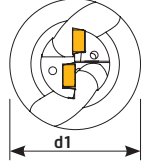
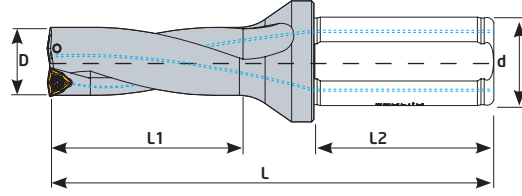

Sipariş Kodu Order Code Best.-Nr.	Stok/Stock/Lager	Ürün Kodu Product Code Produkt-Code	Ölçüler (mm) Dimensions(mm) Abmessungen (mm)							Kullanılan Uç Insert WSP	Sıkma Civatası Clamp Screw Torx-Schraube	Anahtar Torx Key Torx-Schlüssel
			D	d	d1	L	L1	L2	kg			
U104	●	16 D2 WCM_03	16	25	34	108	32	56	0,294	WCM_0302 KRLY	TC060 M2,5x5,5	T8
U105	●	17 D2 WCM_03	17	25	34	110	34	56	0,293			
U106	●	18 D2 WCM_03	18	25	34	113	36	56	0,303	WCM_0302 KRLY	TC060 M2,5x5,5	T8
U107	●	19 D2 WCM_03	19	25	34	115	38	56	0,312			
U108	●	20 D2 WCM_04	20	25	34	119	40	56	0,327	WCM_0402 KRLY	TC060 M2,5x5,5	T8
U110	●	21 D2 WCM_04	21	25	34	121	42	56	0,340			
U112	●	22 D2 WCM_04	22	25	34	123	44	56	0,345			
U114	●	23 D2 WCM_04	23	25	34	127	46	56	0,370			
U116	●	24 D2 WCM_05	24	25	34	130	48	56	0,390	WCM_0503 KRLY	TC065 M3x7	T8
U118	●	25 D2 WCM_05	25	25	34	133	50	56	0,420			
U120	●	26 D2 WCM_05	26	25	34	135	52	56	0,420			
U122	●	27 D2 WCM_05	27	25	34	137	54	56	0,450			
U124	●	28 D2 WCM_05	28	25	39	140	56	56	0,491			
U126	●	29 D2 WCM_05	29	25	39	142	58	56	0,515			
U128	●	30 D2 WCM_06	30	32	44	151	60	58	0,755	WCM_06T3 KRLY	TC067 M3,5x8,5	T10
U130	●	31 D2 WCM_06	31	32	44	154	62	58	0,775			
U132	●	32 D2 WCM_06	32	32	44	156	64	58	0,802			
U134	●	33 D2 WCM_06	33	32	44	159	66	58	0,845			
U136	●	34 D2 WCM_06	34	32	44	161	68	58	0,851			
U137	●	35 D2 WCM_06	35	32	44	164	70	58	0,900			
U138	●	36 D2 WCM_06	36	32	44	167	72	58	0,970			
U139	●	37 D2 WCM_06	37	32	44	170	74	58	0,875			
U140	●	38 D2 WCM_06	38	32	44	173	76	58	0,975			
U141	●	39 D2 WCM_06	39	32	44	175	78	58	1,006			
U142	●	40 D2 WCM_06	40	32	44	178	80	58	1,007			

KRLY ucuna uygundur. / Compatible with KRLY insert. / Kompatibel für KRLY WP

● Stokta/ In Stock/ Lager ○ Sınırlı Stok/ Limited Stock/ Begrenzte Lagerhaltung

Kalite için Teknik Çözüm | Technical Solution For Quality



www.teknikcuttingtools.com

225

D3 WCM_

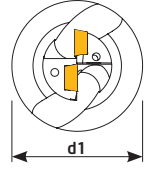
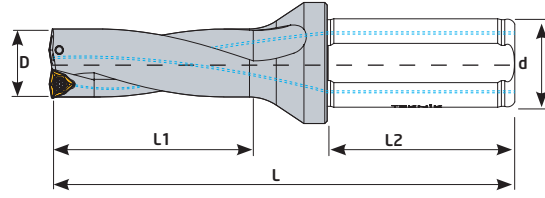

Sipariş Kodu Order Code Best.-Nr.	Stok/Stock/Lager	Ürün Kodu Product Code Produkt-Code	Ölçüler (mm) Dimensions (mm) Abmessungen (mm)								Kullanılan Uç Insert WSP	Sıkma Civatası Clamp Screw Torx-Schraube	Anahtar Torx Key Torx-Schlüssel
			D	d	d1	L	L1	L2	KG				
U143	●	16 D3 WCM_03	16	25	34	124	48	56	0,307	WCM_0302 KRLY	TC060 M2,5x5,5	T8	
U143-1	●	16,5 D3 WCM_03	16,5	25	34	124	48	56	0,304				
U144	●	17 D3 WCM_03	17	25	34	127	51	56	0,320				
U145	●	17,5 D3 WCM_03	17,5	25	34	127	51	56	0,336	WCM_0302 KRLY	TC060 M2,5x5,5	T8	
U146	●	18 D3 WCM_03	18	25	34	131	54	56	0,332				
U147	●	18,5 D3 WCM_03	18,5	25	34	131	54	56	0,348				
U148	●	19 D3 WCM_03	19	25	34	134	57	56	0,338	WCM_0402 KRLY	TC060 M2,5x5,5	T8	
U149	●	19,5 D3 WCM_03	19,5	25	34	134	57	56	0,340				
U150	●	20 D3 WCM_04	20	25	34	139	60	56	0,344				
U151	●	20,5 D3 WCM_04	20,5	25	34	139	60	56	0,360	WCM_0402 KRLY	TC060 M2,5x5,5	T8	
U152	●	21 D3 WCM_04	21	25	34	142	63	56	0,376				
U153	●	21,5 D3 WCM_04	21,5	25	34	142	63	56	0,281				
U154	●	22 D3 WCM_04	22	25	34	145	66	56	0,385	WCM_0402 KRLY	TC060 M2,5x5,5	T8	
U155	●	22,5 D3 WCM_04	22,5	25	34	145	66	56	0,394				
U156	●	23 D3 WCM_04	23	25	34	150	69	56	0,400				
U157	●	23,5 D3 WCM_04	23,5	25	34	150	69	56	0,413	WCM_0503 KRLY	TC065 M3x7	T8	
U158	●	24 D3 WCM_05	24	25	34	154	72	56	0,446				
U159	●	24,5 D3 WCM_05	24,5	25	34	154	72	56	0,453				
U160	●	25 D3 WCM_05	25	25	34	158	75	56	0,467	WCM_0503 KRLY	TC065 M3x7	T8	
U161	●	25,5 D3 WCM_05	25,5	25	34	158	75	56	0,490				
U162	●	26 D3 WCM_05	26	25	34	161	78	56	0,494				
U163	●	26,5 D3 WCM_05	26,5	25	34	161	78	56	0,497	WCM_0503 KRLY	TC065 M3x7	T8	
U164	●	27 D3 WCM_05	27	25	34	164	81	56	0,512				
U165	●	27,5 D3 WCM_05	27,5	25	34	164	81	56	0,520				
U166	●	28 D3 WCM_05	28	25	39	168	84	56	0,576	WCM_0503 KRLY	TC065 M3x7	T8	
U167	●	28,5 D3 WCM_05	28,5	25	39	168	84	56	0,584				
U168	●	29 D3 WCM_05	29	25	39	171	87	56	0,617				
U169	●	29,5 D3 WCM_05	29,5	25	39	171	87	56	0,610	WCM_0503 KRLY	TC065 M3x7	T8	

KRLY ucuna uygundur. / Compatible with KRLY insert. / Kompatibel für KRLY WP



D3 WCM_

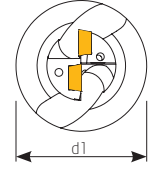
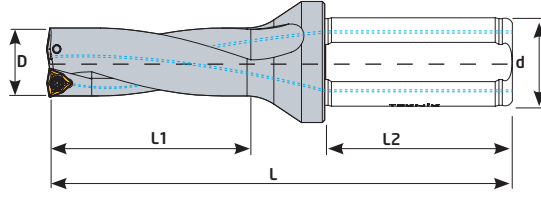

Sipariş Kodu Order Code Best.-Nr.	Stok/Stock/Lager	Ürün Kodu Product Code Produkt-Code	Ölçüler (mm) Dimensions(mm) Abmessungen (mm)								Kullanılan Uç Insert WSP	Sıkma Civatası Clamp Screw Torx-Schraube	Anahtar Torx Key Torx-Schlüssel
			D	d	d1	L	L1	L2	kg				
U170	●	30 D3 WCM_06	30	32	44	181	90	58	0,847	WCM_06T3 KRLY	TC067 M3,5x8,5	T15	
U171	●	30,5 D3 W_M_06	30,5	32	44	181	90	58	0,844				
U172	●	31 D3 WCM_06	31	32	44	185	93	58	0,872				
U174	●	32 D3 WCM_06	32	32	44	188	96	58	0,921				
U176	●	33 D3 WCM_06	33	32	44	192	99	58	0,973				
U178	●	34 D3 WCM_06	34	32	44	195	102	58	1,037				
U179	●	35 D3 WCM_06	35	32	44	199	105	58	1,082				
U180	●	36 D3 WCM_06	36	32	44	203	108	58	1,092				
U181	●	37 D3 WCM_06	37	32	44	207	111	58	1,141				
U182	●	38 D3 WCM_06	38	32	44	211	114	58	1,188				
U183	●	39 D3 WCM_06	39	32	44	214	117	58	1,244				
U184	●	40 D3 WCM_06	40	32	44	218	120	58	1,295				
U186	●	41 D3 WCM_06	41	32	49	232	123	58	1,465				
U188	●	42 D3 WCM_06	42	32	49	235	126	58	1,646				
U190	●	43 D3 WCM_06	43	32	54	239	129	58	1,726				
U192	●	44 D3 WCM_06	44	32	54	242	132	58	1,916				
U194	●	45 D3 WCM_06	45	40	59	247	135	68	2,238				
U196	●	46 D3 WCM_08	46	40	59	251	138	68	2,276				
U198	●	47 D3 WCM_08	47	40	59	254	141	68	1,919				
U200	●	48 D3 WCM_08	48	40	59	258	144	68	2,486				
U201	●	49 D3 WCM_08	49	40	59	261	147	68	5,562				
U202	●	50 D3 WCM_08	50	40	59	265	150	68	2,725				
U203	●	51 D3 WCM_08	51	40	59	268	153	68	2,537				
U205	●	52 D3 WCM_08	52	40	59	271	156	68	2,655				
U207	●	53 D3 WCM_08	53	40	59	274	159	68	2,740				
U209	●	54 D3 WCM_08	54	40	59	277	162	68	3,210				
U211	●	55 D3 WCM_08	55	40	59	280	165	68	3,237				

KRLY ucuna uygundur. / Compatible with KRLY insert. / Kompatible für KRLY WP

● Stokta/In Stock/Lager ○ Sınırlı Stok/Limited Stock/Begrenzte Lagerhaltung

Kalite için Teknik Çözüm | Technical Solution For Quality



www.teknikcuttingtools.com

D4 WCM_

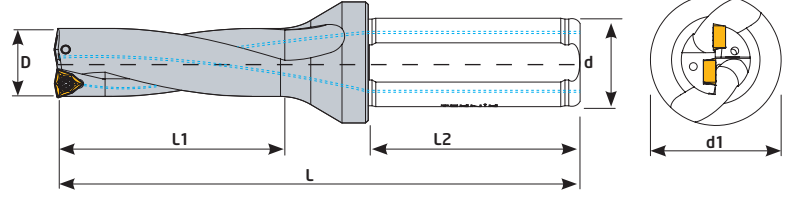

Sipariş Kodu Order Code Best.-Nr.	Stok/Stok/Lager	Ürün Kodu Product Code Produkt-Code	Ölçüler (mm) Dimensions(mm) Abmessungen (mm)							Kullanılan Uç Insert WSP	Sıkma Cıvatası Clamp Screw Torx-Schraube	Anahtar Torx Key Torx-Schlüssel
			D	d	d1	L	L1	L2	kg			
U600	●	16 D4 WCM_03	16	25	34	140	64	56	0,324	WCM_0302 KRLY	TC060 M2,5x5,5	T8
U602	●	17 D4 WCM_03	17	25	34	144	68	56	0,328			
U604	●	18 D4 WCM_03	18	25	34	149	72	56	0,355			
U606	●	19 D4 WCM_03	19	25	34	153	76	56	0,357			
U608	●	20 D4 WCM_04	20	25	34	159	80	56	0,383	WCM_0402 KRLY	TC060 M2,5x5,5	T8
U610	●	21 D4 WCM_04	21	25	34	163	84	56	0,411			
U612	●	22 D4 WCM_04	22	25	34	167	88	56	0,430			
U614	●	23 D4 WCM_04	23	25	34	173	92	56	0,464			
U616	●	24 D4 WCM_05	24	25	34	178	96	56	0,425	WCM_0503 KRLY	TC065 M3x7	T8
U618	●	25 D4 WCM_05	25	25	34	183	100	56	0,526			
U620	●	26 D4 WCM_05	26	25	34	187	104	56	0,542			
U622	●	27 D4 WCM_05	27	25	34	191	108	56	0,580			
U624	●	28 D4 WCM_05	28	25	39	196	112	56	0,662			
U626	●	29 D4 WCM_05	29	25	39	200	116	56	0,680			
U628	●	30 D4 WCM_06	30	32	44	211	120	58	0,912	WCM_06T3 KRLY	TC067 M3,5x8,5	T15
U631	●	31 D4 WCM_06	31	32	44	216	124	58	0,981			
U632	●	32 D4 WCM_06	32	32	44	220	128	58	1,046			
U633	●	33 D4 WCM_06	33	32	44	225	132	58	1,102			
U634	●	34 D4 WCM_06	34	32	44	229	136	58	1,111			
U635	●	35 D4 WCM_06	35	32	44	234	140	58	1,187			
U636	●	36 D4 WCM_06	36	32	44	239	144	58	1,172			
U637	●	37 D4 WCM_06	37	32	44	244	148	58	1,260			
U638	●	38 D4 WCM_06	38	32	44	249	152	58	1,430			
U639	●	39 D4 WCM_06	39	32	44	253	156	58	1,380			
U640	●	40 D4 WCM_06	40	32	44	258	160	58	1,460			

KRLY ucuna uygundur. / Compatible with KRLY insert. / Kompatibel für KRLY WP



D5 WCM_

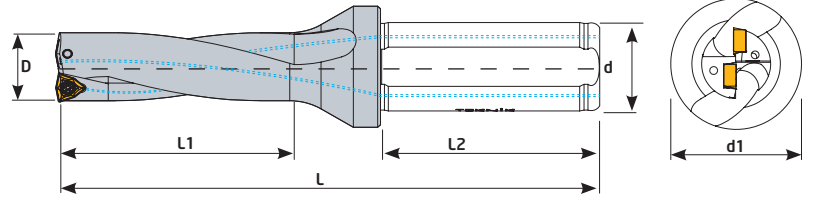

Sipariş Kodu Order Code Best.-Nr.	Stok / Stock / Lager	Ürün Kodu Product Code Produkt-Code	Ölçüler (mm) Dimensions (mm) Abmessungen (mm)							Kullanılan Uç Insert WSP	Sıkma Civatası Clamp Screw Torx-Schraube	Anahtar Torx Key Torx-Schlüssel
			D	d	d1	L	L1	L2	kg			
U776	○	16 D5 WCM_03	16	25	34	156	80	56	0,378	WCM_0302 KRLY	TC060 M2,5x5,5	T8
U777	○	17 D5 WCM_03	17	25	34	161	85	56	0,468			
U778	○	18 D5 WCM_03	18	25	34	167	90	56	0,471			
U779	○	19 D5 WCM_03	19	25	34	172	95	56	0,397			
U780	○	20 D5 WCM_04	20	25	34	179	100	56	0,421	WCM_0402 KRLY	TC060 M2,5x5,5	T8
U781	○	21 D5 WCM_04	21	25	34	184	105	56	0,451			
U782	○	22 D5 WCM_04	22	25	34	190	110	56	0,470			
U783	○	23 D5 WCM_04	23	25	34	196	115	56	0,504			
U784	○	24 D5 WCM_05	24	25	34	202	120	56	0,465	WCM_0503 KRLY	TC065 M3x7	T8
U785	○	25 D5 WCM_05	25	25	34	208	125	56	0,678			
U786	○	26 D5 WCM_05	26	25	34	213	130	56	0,620			
U787	○	27 D5 WCM_05	27	25	34	218	135	56	0,620			
U788	○	28 D5 WCM_05	28	25	39	224	140	56	0,742			
U789	○	29 D5 WCM_05	29	25	39	229	145	56	0,760			
U790	○	30 D5 WCM_06	30	32	44	241	150	58	0,992	WCM_06T3 KRLY	TC067 M3,5x8,5	T15
U791	○	31 D5 WCM_06	31	32	44	246	155	58	1,061			
U792	○	32 D5 WCM_06	32	32	44	252	160	58	1,126			
U793	○	33 D5 WCM_06	33	32	44	258	165	58	1,182			
U794	○	34 D5 WCM_06	34	32	44	263	170	58	1,191			
U795	○	35 D5 WCM_06	35	32	44	269	175	58	1,227			
U796	○	36 D5 WCM_06	36	32	44	275	180	58	1,172			
U797	○	37 D5 WCM_06	37	32	44	281	185	58	1,300			
U798	○	38 D5 WCM_06	38	32	44	287	190	58	1,480			
U799	○	39 D5 WCM_06	39	32	44	292	195	58	1,520			
U800	○	40 D5 WCM_06	40	32	44	298	200	58	1,490			

KRLY ucuna uygundur. / Compatible with KRLY insert. / Kompatibel für KRLY WP

● Stokta / In Stock / Lager ○ Sınırlı Stok / Limited Stock / Begrenzte Lagerhaltung

Kalite için Teknik Çözüm | Technical Solution For Quality

BROTECH

TEKNİK
Cutting Tools

www.teknikcuttingtools.com

229

D2 SPMG

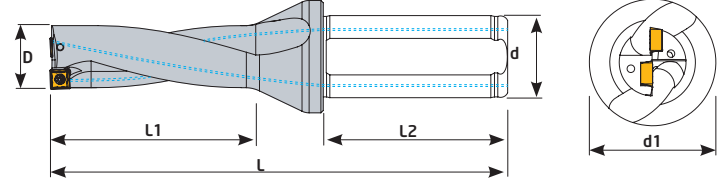

Sipariş Kodu Order Code Best.-Nr.	Stok/Stock/Lager	Ürün Kodu Product Code Produkt-Code	Ölçüler (mm) Dimensions (mm) Abmessungen (mm)								Kullanılan Uç Insert WSP	Sıkma Civatası Clamp Screw Torx-Schraube	Anahtar Torx Key Torx-Schlüssel
			D	d	d1	L	L1	L2	KG				
U913	●	13 D2 SPMG 05	13	20	25	94	26	50	0,145	SPMG 0502 TGTC YG-1	TC058 M2x4,2	T6	
U914	●	14 D2 SPMG 05	14	20	25	96	28	50	0,152				
U915	●	15 D2 SPMG 05	15	20	25	99	30	50	0,157				
U916	●	16 D2 SPMG 06	16	25	34	108	32	56	0,275	SPMG 0602 TGTC YG-1	TC059 M2,2x5	T7	
U917	●	17 D2 SPMG 06	17	25	34	110	34	56	0,291				
U918	●	18 D2 SPMG 06	18	25	34	113	36	56	0,302				
U919	●	19 D2 SPMG 06	19	25	34	115	38	56	0,329				
U920	●	20 D2 SPMG 06	20	25	34	119	40	56	0,334				
U921	●	21 D2 SPMG 06	21	25	34	121	42	56	0,338				
U922	●	22 D2 SPMG 07	22	25	34	123	44	56	0,340	SPMG 07T3 TGTC YG-1	TC063 M2,5x7	T8	
U923	●	23 D2 SPMG 07	23	25	34	127	46	56	0,354				
U924	●	24 D2 SPMG 07	24	25	34	130	48	56	0,382				
U925	●	25 D2 SPMG 07	25	25	34	133	50	56	0,450				
U926	●	26 D2 SPMG 07	26	25	34	135	52	56	0,423				
U927	●	27 D2 SPMG 07	27	25	34	137	54	56	0,435				
U928	●	28 D2 SPMG 09	28	25	39	140	56	56	0,500	SPMG 0904 TGTC YG-1	TC067 M3,5x8,5	T10	
U929	●	29 D2 SPMG 09	29	25	39	142	58	56	0,535				
U930	●	30 D2 SPMG 09	30	32	44	151	60	58	0,735				
U931	●	31 D2 SPMG 09	31	32	44	154	62	58	0,766				
U932	●	32 D2 SPMG 09	32	32	44	156	64	58	0,781				
U933	●	33 D2 SPMG 09	33	32	44	159	66	58	0,815				
U934	●	34 D2 SPMG 11	34	32	44	161	68	58	0,784	SPMG 1104 TGTC YG-1	TC074 M4x10	T15	
U935	●	35 D2 SPMG 11	35	32	44	164	70	58	0,845				
U936	●	36 D2 SPMG 11	36	32	44	167	72	58	0,893				
U937	●	37 D2 SPMG 11	37	32	44	170	74	58	0,931				
U938	●	38 D2 SPMG 11	38	32	44	173	76	58	0,992				
U939	●	39 D2 SPMG 11	39	32	44	175	78	58	1,007				
U940	●	40 D2 SPMG 11	40	32	44	178	80	58	1,020				

TGTC-YG-1 ucuna uygundur. / Compatible with TGTC-YG-1 insert. / Kompatibel für TGTC-YG-1 WP



D3 SPMG

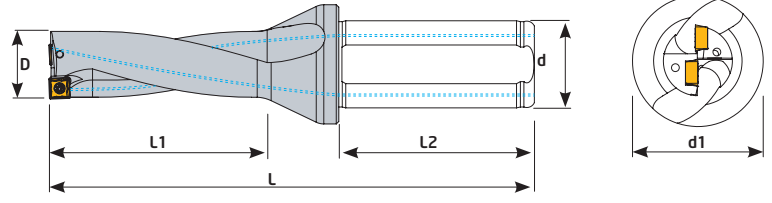

Sipariş Kodu Order Code Best.-Nr.	Stok / Stock / Lager	Ürün Kodu Product Code Produkt-Code	Ölçüler (mm) Dimensions (mm) Abmessungen (mm)								Kullanılan Uç Insert WSP	Sıkma Civatası Clamp Screw Torx-Schraube	Anahtar Torx Key Torx-Schlüssel
			D	d	d1	L	L1	L2	kg				
U812	●	12,5 D3 SPMG 05	12,5	20	12	106	38	50	0,158	SPMG 0502 TGTC YG-1	TC058 M2x4,2	T6	
U813	●	13 D3 SPMG 05	13	20	25	107	39	50	0,164				
U813-1	●	13,5 D3 SPMG 05	13,5	20	25	107	39	50	0,167				
U814	●	14 D3 SPMG 05	14	20	25	110	42	50	0,170				
U814-1	●	14,5 D3 SPMG 05	14,5	20	25	110	42	50	0,170				
U815	●	15 D3 SPMG 05	15	20	25	114	45	50	0,175				
U815-1	●	15,5 D3 SPMG 05	15,5	20	25	114	45	50	0,175				
U816	●	16 D3 SPMG 06	16	25	34	124	48	56	0,302	SPMG 0602 TGTC YG-1	TC059 M2,2x5	T7	
U816-1	●	16,5 D3 SPMG 06	16,5	25	34	124	48	56	0,302				
U817	●	17 D3 SPMG 06	17	25	34	127	51	56	0,318				
U817-1	●	17,5 D3 SPMG 06	17,5	25	34	127	51	56	0,318				
U818	●	18 D3 SPMG 06	18	25	34	131	54	56	0,327				
U818-1	●	18,5 D3 SPMG 06	18,5	25	34	131	54	56	0,327				
U819	●	19 D3 SPMG 06	19	25	34	134	57	56	0,330				
U819-1	●	19,5 D3 SPMG 06	19,5	25	34	134	57	56	0,330				
U820	●	20 D3 SPMG 06	20	25	34	139	60	56	0,347	SPMG 07T3 TGTC YG-1	TC063 M2,5x7	T8	
U820-1	●	20,5 D3 SPMG 06	20,5	25	34	139	60	56	0,350				
U821	●	21 D3 SPMG 06	21	25	34	142	63	56	0,377				
U821-1	●	21,5 D3 SPMG 06	21,5	25	34	142	63	56	0,377				
U822	●	22 D3 SPMG 07	22	25	34	145	66	56	0,375				
U822-1	●	22,5 D3 SPMG 07	22,5	25	34	145	66	56	0,375				
U823	●	23 D3 SPMG 07	23	25	34	150	69	56	0,407				
U823-1	●	23,5 D3 SPMG 07	23,5	25	34	150	69	56	0,412				
U824	●	24 D3 SPMG 07	24	25	34	154	72	56	0,446	SPMG 07T3 TGTC YG-1	TC063 M2,5x7	T8	
U824-1	●	24,5 D3 SPMG 07	24,5	25	34	154	72	56	0,452				
U825	●	25 D3 SPMG 07	25	25	34	158	75	56	0,460				
U825-1	●	25,5 D3 SPMG 07	25,5	25	34	158	75	56	0,467				
U826	●	26 D3 SPMG 07	26	25	34	161	78	56	0,481				
U826-1	●	26,5 D3 SPMG 07	26,5	25	34	161	78	56	0,487				
U827	●	27 D3 SPMG 07	27	25	34	164	81	56	0,504				
U827-1	●	27,5 D3 SPMG 07	27,5	25	34	164	81	56	0,511				

TGTC-YG-1 ucuna uygundur. / Compatible with TGTC-YG-1 insert. / Kompatibel für TGTC-YG-1 WP

● Stokta / In Stock / Lager ○ Sınırlı Stok / Limited Stock / Begrenzte Lagerhaltung

Kalite için Teknik Çözüm | Technical Solution For Quality



www.teknikcuttingtools.com

D3 SPMG

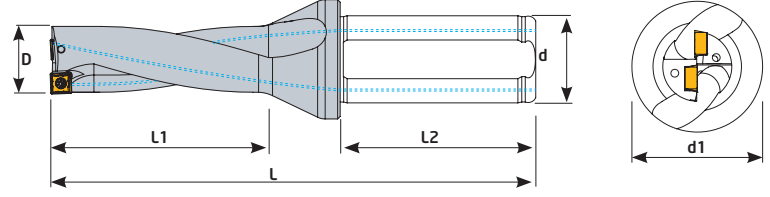

Sipariş Kodu Order Code Best.-Nr.	Stok/Stock/Lager	Ürün Kodu Product Code Produkt-Code	Ölçüler (mm) Dimensions(mm) Abmessungen (mm)							Kullanılan Uç Insert WSP	Sıkma Civatası Clamp Screw Torx-Schraube	Anahtar Torx Key Torx-Schlüssel
			D	d	d1	L	L1	L2	Ⓢ			
U828	●	28 D3 SPMG 09	28	25	39	168	84	56	0,562	SPMG 0904 TGTC YG-1	TC067 M3,5x8,5	T15
U828-1	●	28,5 D3 SPMG 09	28,5	25	39	168	84	56	0,572			
U829	●	29 D3 SPMG 09	29	25	39	171	87	56	0,580			
U829-1	●	29,5 D3 SPMG 09	29,5	25	39	171	87	56	0,585			
U830	●	30 D3 SPMG 09	30	32	44	181	90	58	0,823			
U831	●	31 D3 SPMG 09	31	32	44	185	93	58	0,884			
U832	●	32 D3 SPMG 09	32	32	44	188	96	58	0,923			
U833	●	33 D3 SPMG 09	33	32	44	192	99	58	0,920			
U834	●	34 D3 SPMG 11	34	32	44	195	102	58	0,943	SPMG 1104 TGTC YG-1	TC074 M4x10	T15
U835	●	35 D3 SPMG 11	35	32	44	199	105	58	0,960			
U836	●	36 D3 SPMG 11	36	32	44	203	108	58	1,043			
U837	●	37 D3 SPMG 11	37	32	44	207	111	58	1,057			
U838	●	38 D3 SPMG 11	38	32	44	211	114	58	1,062			
U839	●	39 D3 SPMG 11	39	32	44	214	117	58	1,155			
U840	●	40 D3 SPMG 11	40	32	44	218	120	58	1,238			

TGTC-YG-1 ucuna uygundur. / Compatible with TGTC-YG-1 insert. / Kompatibel für TGTC-YG-1 WP



D4 SPMG

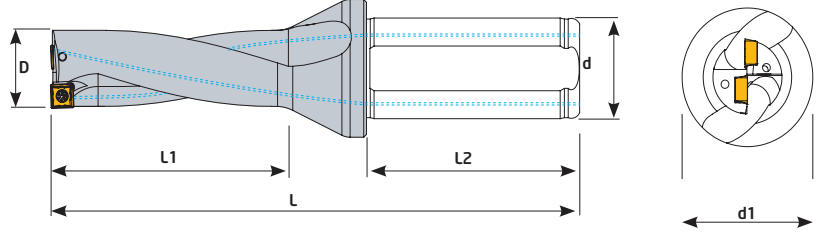

Sipariş Kodu Order Code Best.-Nr.	Stok/Stock/Lager	Ürün Kodu Product Code Produkt-Code	Ölçüler (mm) Dimensions(mm) Abmessungen (mm)							Kullanılan Uç Insert WSP	Sıkma Cıvatası Clamp Screw Torx-Schraube	Anahtar Torx Key Torx-Schlüssel
			D	d	d1	L	L1	L2	kg			
U713	●	13 D4 SPMG 05	13	20	25	120	52	50	0,170	SPMG 0502 TGTC YG-1	TC058 M2x4,2	T6
U714	●	14 D4 SPMG 05	14	20	25	124	56	50	0,180			
U715	●	15 D4 SPMG 05	15	20	25	129	60	50	0,190			
U716	●	16 D4 SPMG 06	16	25	34	140	64	56	0,330	SPMG 0602 TGTC YG-1	TC059 M2,2x5	T7
U717	●	17 D4 SPMG 06	17	25	34	144	68	56	0,333			
U718	●	18 D4 SPMG 06	18	25	34	149	72	56	0,350			
U719	●	19 D4 SPMG 06	19	25	34	153	76	56	0,357			
U720	●	20 D4 SPMG 06	20	25	34	159	80	56	0,383			
U721	●	21 D4 SPMG 06	21	25	34	163	84	56	0,387			
U722	●	22 D4 SPMG 07	22	25	34	167	88	56	0,417	SPMG 07T3 TGTC YG-1	TC063 M2,5x7	T8
U723	●	23 D4 SPMG 07	23	25	34	173	92	56	0,448			
U724	●	24 D4 SPMG 07	24	25	34	178	96	56	0,460			
U725	●	25 D4 SPMG 07	25	25	34	183	100	56	0,505			
U726	●	26 D4 SPMG 07	26	25	34	187	104	56	0,539			
U727	●	27 D4 SPMG 07	27	25	34	191	108	56	0,561			
U728	●	28 D4 SPMG 09	28	25	39	196	112	56	0,642	SPMG 0904 TGTC YG-1	TC067 M3,5x8,5	T15
U729	●	29 D4 SPMG 09	29	25	39	200	116	56	0,646			
U730	●	30 D4 SPMG 09	30	32	44	211	120	58	0,930			
U731	●	31 D4 SPMG 09	31	32	44	216	124	58	0,974			
U732	●	32 D4 SPMG 09	32	32	44	220	128	58	1,014			
U733	●	33 D4 SPMG 09	33	32	44	225	132	58	1,050			
U734	●	34 D4 SPMG 11	34	32	44	229	136	58	1,040	SPMG 1104 TGTC YG-1	TC074 M4x10	T15
U735	●	35 D4 SPMG 11	35	32	44	234	140	58	1,155			
U736	●	36 D4 SPMG 11	36	32	44	239	144	58	1,185			
U737	●	37 D4 SPMG 11	37	32	44	244	148	58	1,232			
U738	●	38 D4 SPMG 11	38	32	44	249	152	58	1,320			
U739	●	39 D4 SPMG 11	39	32	44	253	156	58	1,356			
U740	●	40 D4 SPMG 11	40	32	44	258	160	58	1,421			

TGTC-YG-1 ucuna uygundur. / Compatible with TGTC-YG-1 insert. / Kompatible für TGTC-YG-1 WP

● Stokta/In Stock/Lager ○ Sınırlı Stok/Limited Stock/Begrenzte Lagerhaltung

Kalite için Teknik Çözüm | Technical Solution For Quality



www.teknikcuttingtools.com

D3 SPMT

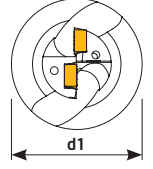
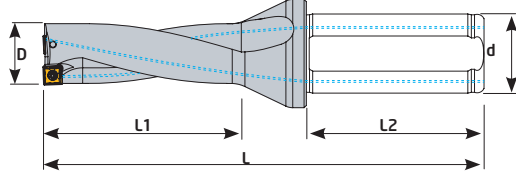

Sipariş Kodu Order Code Best.-Nr.	Stok/Stock/Lager	Ürün Kodu Product Code Produkt-Code	Ölçüler (mm) Dimensions (mm) Abmessungen (mm)							Kullanılan Uç Insert WSP	Sıkma Civatası Clamp Screw Torx-Schraube	Anahtar Torx Key Torx-Schlüssel
			D	d	d1	L	L1	L2	kg			
U004	●	13 D3 SPMT 05	13	20	25	107	39	50	0,154	SPMT 0502 KRLY	TC058 M2x4,2	T6
U006	●	14 D3 SPMT 05	14	20	25	110	42	50	0,158			
U008	●	15 D3 SPMT 05	15	20	25	114	45	50	0,168			
U010	●	16 D3 SPMT 06	16	25	34	124	48	56	0,308	SPMT 0602 KRLY	TC059 M2,2x5	T7
U012	●	17 D3 SPMT 06	17	25	34	127	51	56	0,313			
U014	●	18 D3 SPMT 06	18	25	34	131	54	56	0,327			
U016	●	19 D3 SPMT 06	19	25	34	134	57	56	0,350			
U018	●	20 D3 SPMT 07	20	25	34	139	60	56	0,353	SPMT 0702 KRLY	TC063 M2,5x7	T8
U020	●	21 D3 SPMT 07	21	25	34	142	63	56	0,395			

KRLY ucuna uygundur. / Compatible with KRLY insert. / Kompatible für KRLY WP



D3 SOMT

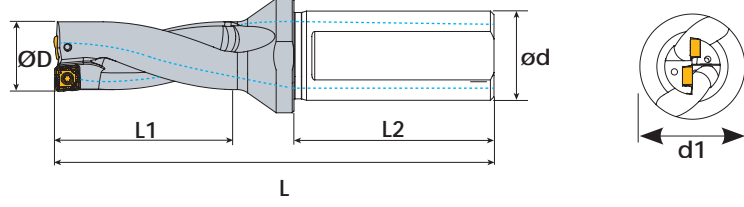

Sipariş Kodu Order Code Best.-Nr.	Stok / Stock / Lager	Ürün Kodu Product Code Produkt-Code	Ölçüler (mm) Dimensions (mm) Abmessungen (mm)								Kullanılan Uç Insert WSP	Sıkma Cıvatası Clamp Screw Torx-Schraube	Anahtar Torx Key Torx-Schlüssel
			D	d	d1	L	L1	L2	kg				
U300	○	13 D3 SOMT 05	13	20	25	111	39	50	0,157	SOMT 0502 TGTC	TC058 M2x4,2	T6	
U302	○	14 D3 SOMT 05	14	20	25	114	42	50	0,165				
U303	○	14,5 D3 SOMT 05	14,5	20	25	114	42	50	0,170				
U304	○	15 D3 SOMT 05	15	20	25	117	45	50	0,175				
U305	○	15,5 D3 SOMT 05	15,5	20	25	117	45	50	0,175				
U306	○	16 D3 SOMT 05	16	25	34	126	48	56	0,302				
U307	○	16,5 D3 SOMT 06	16,5	25	34	126	48	56	0,302	SOMT 0602 TGTC	TC059 M2,2x5	T7	
U308	○	17 D3 SOMT 06	17	25	34	129	51	56	0,318				
U309	○	17,5 D3 SOMT 06	17,5	25	34	129	51	56	0,318				
U310	○	18 D3 SOMT 06	18	25	34	132	54	56	0,327				
U311	○	18,5 D3 SOMT 06	18,5	25	34	132	54	56	0,327				
U312	○	19 D3 SOMT 06	19	25	34	135	57	56	0,330				
U313	○	19,5 D3 SOMT 07	19,5	25	34	135	57	56	0,330	SOMT 0703 TGTC	TC063 M2,5x7	T8	
U314	○	20 D3 SOMT 07	20	25	34	138	60	56	0,347				
U315	○	20,5 D3 SOMT 07	20,5	25	34	138	60	56	0,350				
U316	○	21 D3 SOMT 07	21	25	34	141	63	56	0,377				
U318	○	22 D3 SOMT 08	22	25	34	144	66	56	0,375				
U319	○	22,5 D3 SOMT 08	22,5	25	34	144	66	56	0,375				
U320	○	23 D3 SOMT 08	23	25	34	147	69	56	0,407	SOMT 08T3 TGTC	TC063 M2,5x7	T8	
U321	○	23,5 D3 SOMT 08	23,5	25	34	147	69	56	0,412				
U322	○	24 D3 SOMT 08	24	25	34	150	72	56	0,446				
U323	○	24,5 D3 SOMT 08	24,5	25	34	150	72	56	0,452				
U324	○	25 D3 SOMT 08	25	25	34	153	75	56	0,460				

TGTC ucuna uygundur. / Compatible with TGTC insert. / Kompatibel für TGTC WP

D4 SOMT

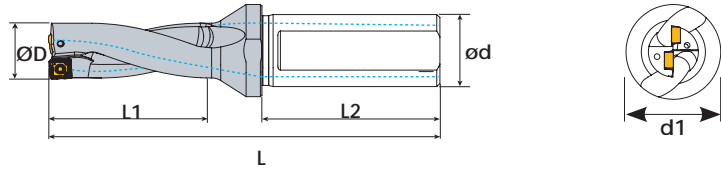

Sipariş Kodu Order Code Best.-Nr.	Stok / Stock / Lager	Ürün Kodu Product Code Produkt-Code	Ölçüler (mm) Dimensions (mm) Abmessungen (mm)								Kullanılan Uç Insert WSP	Sıkma Cıvatası Clamp Screw Torx-Schraube	Anahtar Torx Key Torx-Schlüssel
			D	d	d1	L	L1	L2	kg				
U402	○	14 D4 SOMT 05	14	20	25	128	56	50	0,170	SOMT 0502 TGTC	TC058 M2x4,2	T6	
U403	○	14,5 D4 SOMT 05	14,5	20	25	128	56	50	0,175				
U406	○	16 D4 SOMT 05	16	25	34	142	64	56	0,322				
U408	○	17 D4 SOMT 06	17	25	34	146	68	56	0,338				
U409	○	17,5 D4 SOMT 06	17,5	25	34	146	68	56	0,348				
U410	○	18 D4 SOMT 06	18	25	34	150	72	56	0,347				
U412	○	19 D4 SOMT 06	19	25	34	154	76	56	0,350	SOMT 0602 TGTC	TC059 M2,2x5	T7	
U414	○	20 D4 SOMT 07	20	25	34	158	80	56	0,387				
U416	○	21 D4 SOMT 07	21	25	34	162	84	56	0,417				
U418	○	22 D4 SOMT 07	22	25	34	166	88	56	0,425				
U420	○	24 D4 SOMT 08	24	25	34	174	96	56	0,486				
U422	○	25 D4 SOMT 08	25	25	34	178	100	56	0,498				

TGTC ucuna uygundur. / Compatible with TGTC insert. / Kompatibel für TGTC WP

● Stokta / In Stock / Lager ○ Sınırlı Stok / Limited Stock / Begrenzte Lagerhaltung

D2-D3 XCMT-QCMT

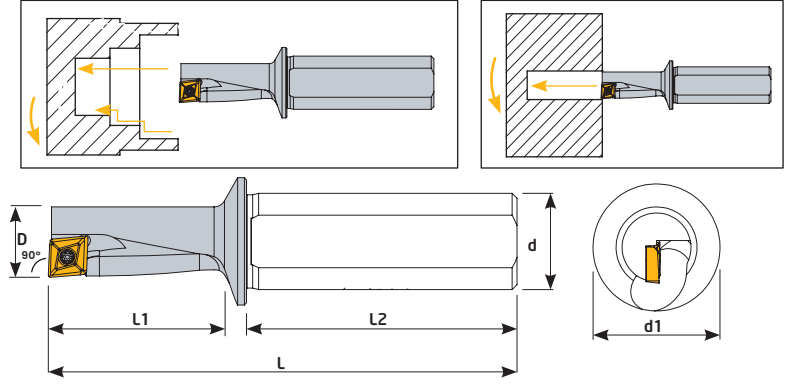

Sipariş Kodu Order Code Best.-Nr.	Stok/Stock/Lager	Ürün Kodu Product Code Produkt-Code	Ölçüler (mm) Dimensions(mm) Abmessungen (mm)							Kullanılan Uç Insert WSP	Sıkma Civatası Clamp Screw Torx-Schraube	Anahtar Torx Key Torx-Schlüssel
			D	d	d1	L	L1	L2	kg			
U030	●	10 D2,25 QC-- 050204	10	12	16	74,5	22,5	42	0,062	QC-- 050204 KRLY	TC058 M2x4,2	T6
U032	●	12 D2,25 QC-- 060204	12	16	20	85	27	45	0,100	QC-- 060204 KRLY	TC059 M2,2x5	T7
U034	●	14 D2,25 QC-- 070304	14	16	20	90	31,5	45	0,111	QC-- 070304 KRLY	TC060 M2,5x5,5	T8
U036	●	16 D2,25 QC-- 080304	16	20	25	100	36	50	0,191	QC-- 080304 KRLY	TC065 M3x7	
U040	●	20 D2,25 QC-- 10T304	20	25	31	116	45	56	0,330	QC-- 10T304 KRLY	TC067 M3,5x8,5	T15
U042	●	25 D2,25 QC-- 130404	25	32	39	135	56,5	60	0,600	QC-- 130404 KRLY	TC080 M4,5x11	
U038	●	18 D2,25 XC-- 09T304	18	25	31	112	40,5	56	0,356	XCMT 09T304 ISCR	TC065 M3x7	T8

KRLY ucuna uygundur. / Compatible with KRLY insert. / Kompatibel für KRLY WP
QC-- 09T304 ucuna uygundur. / QC-- 09T304 compatible with ISCR insert. / QC-- 09T304 kompatibel für ISCR WP

Sipariş Kodu Order Code Best.-Nr.	Stok/Stock/Lager	Ürün Kodu Product Code Produkt-Code	Ölçüler (mm) Dimensions(mm) Abmessungen (mm)							Kullanılan Uç Insert WSP	Sıkma Civatası Clamp Screw Torx-Schraube	Anahtar Torx Key Torx-Schlüssel
			D	d	d1	L	L1	L2	kg			
U08	●	8 D2 XC-- 040104	8	12	16	68	18	42	0,056	XCMT 040104 TGTC	TC058 M2x4,2	T6
U12	●	10 D3 XC-- 050204	10	16	25	90	30	45	0,109	XCMT 050204 TGTC	TC058 M2x4,5	
U14	●	10,5 D3 XC-- 050204	10,5	16	25	90	31	45	0,111	XCMT 060204 TGTC	TC059 M2,2x5	T7
U18	●	11,5 D3 XC-- 060204	11,5	16	25	92	35	45	0,113			
U20	●	12 D3 XC-- 060204	12	16	25	94	36	45	0,114			

TGTC ucuna uygundur. / Compatible with TGTC insert. / Kompatibel für TGTC WP

Alüminyum İçin/For Aluminum/ Für Aluminium

Sipariş Kodu Order Code Best.-Nr.	Stok/Stock/Lager	Ürün Kodu Product Code Produkt-Code	Ölçüler (mm) Dimensions(mm) Abmessungen (mm)							Kullanılan Uç Insert WSP	Sıkma Civatası Clamp Screw Torx-Schraube	Anahtar Torx Key Torx-Schlüssel
			D	d	d1	L	L1	L2	kg			
U32	●	10,5 D3 XC-- 050204	10,5	16	25	90	31	45	0,114	XCGT 050204 TGTC	TC058 M2x4,2	T6
U34	●	11 D3 XC-- 050204	11	16	25	92	33	45	0,112			
U36	●	11,5 D3 XC-- 060204	11,5	16	25	92	35	45	0,112	XCGT 060204 TGTC	TC059 M2,2x5	T7

TGTC ucuna uygundur. / Compatible with TGTC insert. / Kompatibel für TGTC WP



Kanal Kater
Grooving Holders
Stech-Klemmhalter



**Technical Solution
for Quality**



KRLY-R

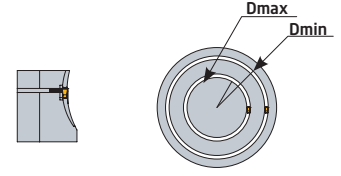
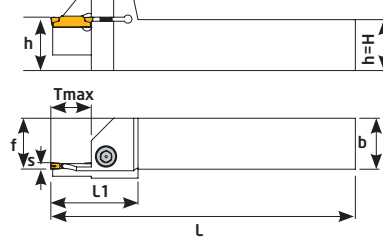
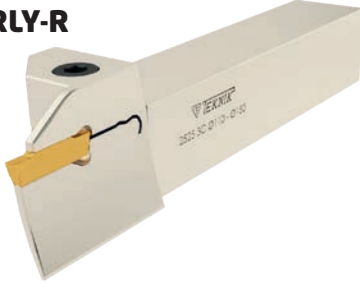

Sipariş Kodu Order Code Best.-Nr.	Stok/Stock/Lager	Ürün Kodu Product Code Produkt-Code	Ölçüler (mm) Dimensions(mm) Abmessungen (mm)										Kullanılan Uç Insert WSP	Civata Clamp Screw Inbuss-Schraube	Anahtar Allen Key Inbuss-Schlüssel
			Dmin	Dmax	S	Tmax	f	b	h=H	L	L1	Ⓢ			
D780	●	2525 3C-R (50-60)	50	60	3	17	25	25	25	150	40	0,741	MGM 300 KRLY	TC134 M6x20	5 Allen
D782	●	2525 3C-R (60-80)	60	80	3	17	25	25	25	150	40	0,717			
D784	●	2525 3C-R (80-110)	80	110	3	17	25	25	25	150	40	0,720			
D785	●	2525 3C-R (110-150)	110	150	3	17	25	25	25	150	40	0,730	MGM 400 KRLY		
D786	●	2525 4C-R (50-60)	50	60	4	20	25	25	25	150	45	0,704			
D788	●	2525 4C-R (60-80)	60	80	4	20	25	25	25	150	45	0,712			
D790	●	2525 4C-R (80-110)	80	110	4	20	25	25	25	150	45	0,701	MGM 500 KRLY		
D791	●	2525 4C-R (110-150)	110	150	4	20	25	25	25	150	45	0,712			
D791-1	●	2525 4C (140-600)	140	600	4	25	25	25	25	150	49	0,667			
D792	●	2525 5C-R (50-80)	50	80	5	20	25	25	25	150	45	0,721	MGM 500 KRLY		
D796	●	2525 5C-R (80-110)	80	110	5	20	25	25	25	150	45	0,716			
D798	●	2525 5C-R (110-150)	110	150	5	20	25	25	25	150	45	0,718			
D799-1	●	2525 5C-R (350-500)	350	500	5	20	25	25	25	150	45	0,713			
D799-2	●	2525 5C-R (140-600)	140	600	5	25	25	25	25	150	49	0,664			

KRLY-L

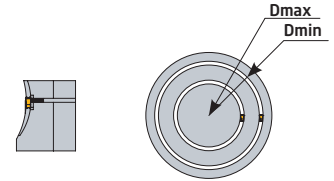
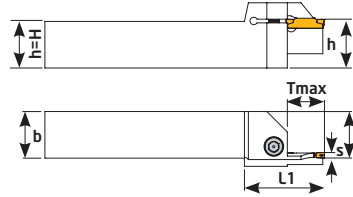

Sipariş Kodu Order Code Best.-Nr.	Stok/Stock/Lager	Ürün Kodu Product Code Produkt-Code	Ölçüler (mm) Dimensions(mm) Abmessungen (mm)										Kullanılan Uç Insert WSP	Civata Clamp Screw Inbuss-Schraube	Anahtar Allen Key Inbuss-Schlüssel
			Dmin	Dmax	S	Tmax	f	b	h=H	L	L1	Ⓢ			
D800	●	2525 3C-L (50-60)	50	60	3	17	25	25	25	150	40	0,741	MGM 300 KRLY	TC134 M6x20	5 Allen
D802	●	2525 3C-L (60-80)	60	80	3	17	25	25	25	150	40	0,717			
D804	●	2525 3C-L (80-110)	80	110	3	17	25	25	25	150	40	0,720			
D805	●	2525 3C-L (110-150)	110	150	3	17	25	25	25	150	40	0,730	MGM 400 KRLY		
D806	●	2525 4C-L (50-60)	50	60	4	20	25	25	25	150	45	0,704			
D808	●	2525 4C-L (60-80)	60	80	4	20	25	25	25	150	45	0,712			
D810	●	2525 4C-L (80-110)	80	110	4	20	25	25	25	150	45	0,700	MGM 500 KRLY		
D811	●	2525 4C-L (110-150)	110	150	4	20	25	25	25	150	45	0,712			
D811-1	●	2525 4C-L (140-600)	140	600	4	25	25	25	25	150	49	0,667			
D812	●	2525 5C-L (50-80)	50	80	5	20	25	25	25	150	45	0,721	MGM 500 KRLY		
D816	●	2525 5C-L (80-110)	80	110	5	20	25	25	25	150	45	0,716			
D818	●	2525 5C-L (110-150)	110	150	5	20	25	25	25	150	45	0,718			
D819	●	2525 5C-L (140-600)	140	600	5	25	25	25	25	150	49	0,664			
D819-1	●	2525 5C-L (350-500)	350	500	5	20	25	25	25	150	45	0,713			

KRLY ucuna uygundur. / Compatible with KRLY insert. / Kompatibel für KRLY WP

● Stokta/In Stock/Lager ○ Sınırlı Stok/Limited Stock/Begrenzte Lagerhaltung



MGM /R

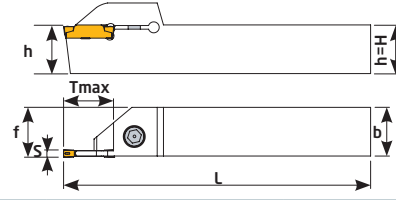

Sipariş Kodu Order Code Best.-Nr.	Stok/Stock/Lager	Ürün Kodu Product Code Produkt-Code	Ölçüler (mm) Dimensions(mm) Abmessungen (mm)							Kullanılan Uç Insert WSP	Sıkma Civatası Clamp Screw Inbuss-Schraube	Anahtar Allen Key Inbuss-Schlüssel
			h=H	b	S	Tmax	f	L				
D658	●	1212 2C-R MGM	12	12	2	16	12	125	0,162	MGM 200 KRLY	TC131 M5x16	4 Allen
D660	●	1616 2C-R MGM	16	16	2	16	16	125	0,250			
D662	●	2020 2C-R MGM	20	20	2	16	20	125	0,404		TC132 M5x20	5 Allen
D664	●	2525 2C-R MGM	25	25	2	16	25	150	0,726			
D666	●	3232 2C-R MGM	32	32	2	16	32	170	1,349	MGM 300 KRLY	TC131 M5x16	4 Allen
D667	●	1212 3C-R MGM	12	12	3	18	12	125	0,162			
D668	●	1616 3C-R MGM	16	16	3	18	16	125	0,268		TC132 M5x20	5 Allen
D670	●	2020 3C-R MGM	20	20	3	18	20	125	0,407			
D672	●	2525 3C-R MGM	25	25	3	18	25	150	0,727	MGM 400 KRLY	TC134 M6x20	5 Allen
D674	●	3232 3C-R MGM	32	32	3	20	32	170	1,280			
D675	●	1616 4C-R MGM	16	16	4	18	16	125	0,273		TC131 M5x16	4 Allen
D676	●	2020 4C-R MGM	20	20	4	18	20	125	0,408			
D678	●	2525 4C-R MGM	25	25	4	18	25	150	0,727	MGM 500 KRLY	TC132 M5x20	4 Allen
D680	●	3232 4C-R MGM	32	32	4	20	32	170	1,287			
D682	●	2020 5C-R MGM	20	20	5	25	20	125	0,391		TC134 M6x20	5 Allen
D684	●	2525 5C-R MGM	25	25	5	25	25	150	0,703			
D686	●	3232 5C-R MGM	32	32	5	25	32	170	1,268	MGM 600 KRLY	TC136 M8x20	6 Allen
D687	●	2525 6C-R MGM	25	25	6	27	25	150	0,745			

MGM /R

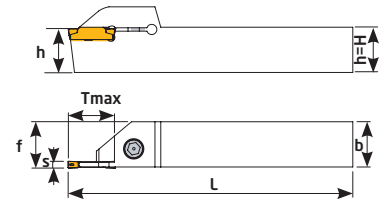
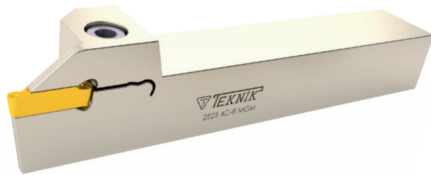

Sipariş Kodu Order Code Best.-Nr.	Stok/Stock/Lager	Ürün Kodu Product Code Produkt-Code	Ölçüler (mm) Dimensions(mm) Abmessungen (mm)							Kullanılan Uç Insert WSP	Sıkma Civatası Clamp Screw Inbuss-Schraube	Anahtar Allen Key Inbuss-Schlüssel
			h=H	b	S	Tmax	f	L				
D960	●	2525 3C-R MGM	25	25	3	25	25	150	0,727	MGM 300 KRLY	TC134 M6x20	5 Allen
D963	●	2525 3C-R MGM	25	25	3	40	25	170	0,722			
D961	●	2525 4C-R MGM	25	25	4	25	25	150	0,727	MGM 400 KRLY	TC134 M6x20	5 Allen
D964	●	2525 4C-R MGM	25	25	4	40	25	170	0,721			
D962	●	2525 5C-R MGM	25	25	5	40	25	170	0,745	MGM 500 KRLY		

KRLY ucuna uygundur. / Compatible with KRLY insert. / Kompatibel für KRLY WP
● Stokta/In Stock/Lager ○ Sınırlı Stok/Limited Stock/Begrenzte Lagerhaltung

MGM /L

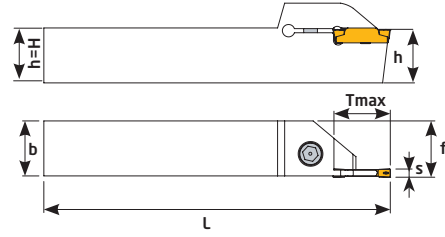
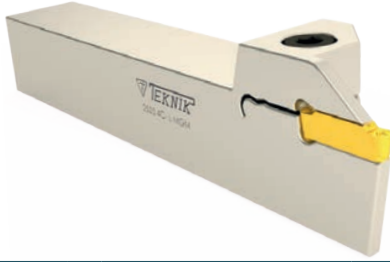

Sipariş Kodu Order Code Best.-Nr.	Stok/Stock/Lager	Ürün Kodu Product Code Produkt-Code	Ölçüler (mm) Dimensions(mm) Abmessungen (mm)							Kullanılan Uç Insert WSP	Sıkma Civatası Clamp Screw Inbuss-Schraube	Anahtar Allen Key Inbuss-Schlüssel
			h=H	b	S	Tmax	f	L	KG			
D607	●	1212 2C-L MGM	12	12	2	16	12	125	0,161	MGM 200 KRLY	TC131 M5x16	4 Allen
D608	●	1616 2C-L MGM	16	16	2	16	16	125	0,250		TC132 M5x20	
D610	●	2020 2C-L MGM	20	20	2	16	20	125	0,404		TC134 M6x20	5 Allen
D611	●	2525 2C-L MGM	25	25	2	16	25	150	0,726			
D612	●	1616 3C-L MGM	16	16	3	18	16	125	0,268	MGM 300 KRLY	TC131 M5x16	4 Allen
D614	●	2020 3C-L MGM	20	20	3	18	20	125	0,407		TC132 M5x20	
D615	●	2525 3C-L MGM	25	25	3	18	25	150	0,750		TC134 M6x20	5 Allen
D617	●	2020 4C-L MGM	20	20	4	18	20	125	0,407	MGM 400 KRLY	TC132 M5x20	4 Allen
D618	●	2525 4C-L MGM	25	25	4	18	25	150	0,727			
D620	●	2525 5C-L MGM	25	25	5	25	25	150	0,703	MGM 500 KRLY	TC134 M6x20	5 Allen
D621	●	2525 6C-L MGM	25	25	5	27	25	150	0,745	MGM 600 KRLY		

KGMN /R

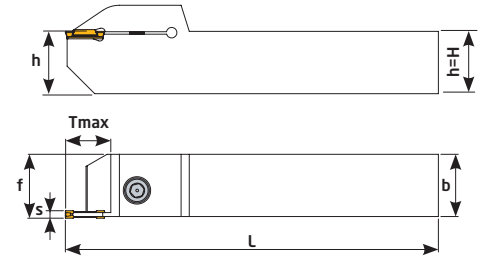

Sipariş Kodu Order Code Best.-Nr.	Stok/Stock/Lager	Ürün Kodu Product Code Produkt-Code	Ölçüler (mm) Dimensions(mm) Abmessungen (mm)							Kullanılan Uç Insert WSP	Sıkma Civatası Clamp Screw Inbuss-Schraube	Anahtar Allen Key Inbuss-Schlüssel
			h=H	b	S	Tmax	f	L	KG			
D635	●	2020 2C-R KGMN	20	20	2	18	20	125	0,412	KGMN 200 KRLY	TC132 M5x20	4 Allen
D636	●	2525 2C-R KGMN	25	25	2	18	25	150	0,726		TC134 M6x20	5 Allen
D637	●	2020 3C-R KGMN	20	20	3	20	20	125	0,406	KGMN 300 KRLY	TC132 M5x20	4 Allen
D638	●	2525 3C-R KGMN	25	25	3	22	25	150	0,732		TC134 M6x20	5 Allen
D639	●	2020 4C-R KGMN	20	20	4	20	20	125	0,406	KGMN 400 KRLY	TC132 M5x20	4 Allen
D640	●	2525 4C-R KGMN	25	25	4	22	25	152	0,737		TC134 M6x20	5 Allen

KRLY ucuna uygundur. / Compatible with KRLY insert. / Kompatibel für KRLY WP



KGMN

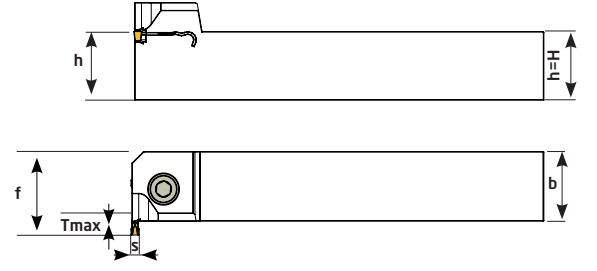

Sipariş Kodu Order Code Best.-Nr.	Stok/Stock/Lager	Ürün Kodu Product Code Produkt-Code	Ölçüler (mm) Dimensions(mm) Abmessungen (mm)								Kullanılan Uç Insert WSP	Sıkma Civatası Clamp Screw Inbuss-Schraube	Anahtar Allen Key Inbuss-Schlüssel
			Dmin	h=H	b	S	Tmax	f	L	kg			
D622	●	2020 2C KGEVR-KGMN	120	20	20	2	3,5	23,5	125	0,412	KGMN 200 KRLY	TC132 M5x20	4 Allen
D623	●	2525 2C KGEVR-KGMN	80	25	25	2	3,5	28,5	150	0,833		TC134 M6x20	5 Allen
D624	●	2020 3C KGEVR-KGMN	120	20	20	3	5	25	125	0,468	KGMN 300 KRLY	TC132 M5x20	4 Allen
D625	●	2525 3C KGEVR-KGMN	80	25	25	3	5	30	150	0,837		TC134 M6x20	5 Allen
D626	●	2020 4C KGEVR-KGMN	120	20	20	4	5	25	125	0,463	KGMN 400 KRLY	TC132 M5x20	4 Allen
D627	●	2525 4C KGEVR-KGMN	80	25	25	4	5	30	150	0,464		TC134 M6x20	5 Allen

KRLY ucuna uygundur. / Compatible with KRLY insert. / Kompatible für KRLY WP

GRP /R

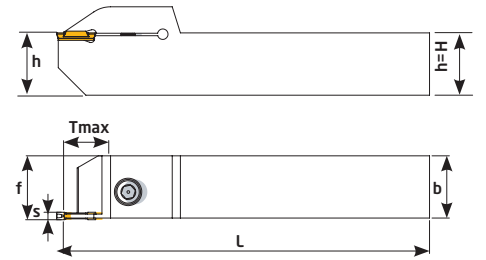

Sipariş Kodu Order Code Best.-Nr.	Stok/Stock/Lager	Ürün Kodu Product Code Produkt-Code	Ölçüler (mm) Dimensions(mm) Abmessungen (mm)								Kullanılan Uç Insert WSP	Sıkma Civatası Clamp Screw Inbuss-Schraube	Anahtar Allen Key Inbuss-Schlüssel
			h=H	b	S	Tmax	f	L	kg				
D773	●	2020 3C-R GRP	20	20	3	18	20	125	0,409	GRP 3C ISCR	TC132 M5x20	4 Allen	
D769	●	2525 3C-R GRP	25	25	3	18	25	150	0,755		GRP 4C ISCR	TC134 M6x20	5 Allen
D770	●	2525 4C-R GRP	25	25	4	20	25	150	0,747				
D772	○	3232 4C-R GRP	32	32	4	18	32	170	1,285				
D771	●	2525 5C-R GRP	25	25	5	24	25	150	0,739	GRP 5C ISCR	TC134 M6x20	5 Allen	
D774	○	3232 5C-R GRP	32	32	5	24	32	170	1,264				

ISCR ucuna uygundur. / Compatible with ISCR insert. / Kompatible für ISCR WP

● Stokta/ In Stock/ Lager ○ Sınırlı Stok/ Limited Stock/ Begrenzte Lagerhaltung

Kalite için Teknik Çözüm | Technical Solution For Quality



www.teknikcuttingtools.com

ISCR /R

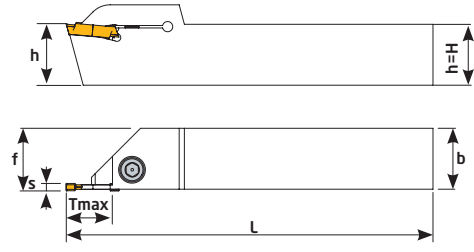

Sipariş Kodu Order Code Best.-Nr.	Stok/Stock/Lager	Ürün Kodu Product Code Produkt-Code	Ölçüler (mm) Dimensions(mm) Abmessungen (mm)							Kullanılan Uç Insert WSP	Sıkma Cıvatası Clamp Screw Inbuss-Schraube	Anahtar Allen Key Inbuss-Schlüssel
			h=H	b	S	Tmax	f	L	kg			
D750	●	1212 2C-R DGN	12	12	2	16	12	125	0,158	DGN 2C ISCR	TC131 M5x16	4 Allen
D752	●	1616 2C-R DGN	16	16	2	16	16	125	0,260		TC132 M5x20	
D754	●	2020 2C-R DGN	20	20	2	18	20	125	0,398		TC134 M6x20	5 Allen
D756	●	2525 2C-R DGN	25	25	2	19	25	150	0,712	DGN 3C ISCR	TC131 M5x16	4 Allen
D758	●	1212 3C-R DGN	12	12	3	16	12	125	0,160		TC132 M5x20	
D760	●	1616 3C-R DGN	16	16	3	19	16	125	0,253		TC134 M6x20	5 Allen
D762	●	2020 3C-R DGN	20	20	3	20	20	125	0,394	DGN 4C ISCR	TC131 M5x16	4 Allen
D764	●	2525 3C-R DGN	25	25	3	22	25	150	0,711		TC132 M5x20	
D764-1	●	2525 3C-R DGN	25	25	3	25	25	150	0,711		TC134 M6x20	5 Allen
D775	●	2020 4C-R DGN	20	20	4	20	20	125	0,391	DGN 4C ISCR	TC132 M5x20	4 Allen
D777	●	2525 4C-R DGN	25	25	4	20	25	150	0,709		TC134 M6x20	5 Allen

ISCR /L

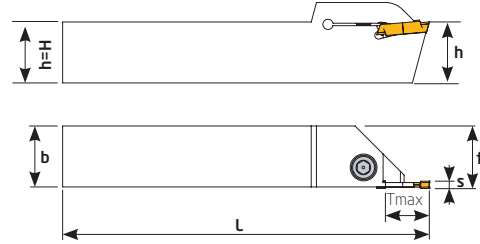

Sipariş Kodu Order Code Best.-Nr.	Stok/Stock/Lager	Ürün Kodu Product Code Produkt-Code	Ölçüler (mm) Dimensions(mm) Abmessungen (mm)							Kullanılan Uç Insert WSP	Sıkma Cıvatası Clamp Screw Inbuss-Schraube	Anahtar Allen Key Inbuss-Schlüssel
			h=H	b	S	Tmax	f	L	kg			
D726	●	1212 2C-L DGN	12	12	2	16	12	125	0,158	DGN 2C ISCR	TC131 M5x16	4 Allen
D727	●	1616 2C-L DGN	16	16	2	16	16	125	0,260		TC132 M5x20	
D728	●	2020 2C-L DGN	20	20	2	18	20	125	0,398		TC134 M6x20	5 Allen
D729	●	2525 2C-L DGN	25	25	2	19	25	150	0,712	DGN 3C ISCR	TC131 M5x16	4 Allen
D730	●	1212-3C-L DGN	12	12	3	16	12	125	0,160		TC132 M5x20	
D731	●	1616 3C-L DGN	16	16	3	19	16	125	0,253		TC134 M6x20	5 Allen
D732	●	2020 3C-L DGN	20	20	3	20	20	125	0,394	DGN 4C ISCR	TC131 M5x16	4 Allen
D733	●	2525 3C-L DGN	25	25	3	22	25	150	0,711		TC132 M5x20	

ISCR ucuna uygundur. / Compatible with ISCR insert. / Kompatibel für ISCR WP



ZCC/R ZT-D

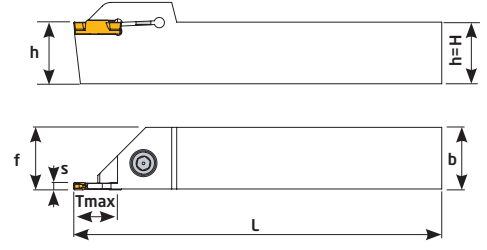

Sipariş Kodu Order Code Best.-Nr.	Stok/Stock/Lager	Ürün Kodu Product Code Produkt-Code	Ölçüler (mm) Dimensions(mm) Abmessungen (mm)							Kullanılan Uç Insert WSP	Sıkma Civatası Clamp Screw Inbuss-Schraube	Anahtar Allen Key Inbuss-Schlüssel
			h=H	b	S	Tmax	f	L	kg			
D027	●	1616 3C-R ZT-D	16	16	3	18	16	125	0,301	ZT.D 3C ZCC	TC131 M5x16	4 Allen
D028	●	2020 3C-R ZT-D	20	20	3	18	20	125	0,394		TC132 M5x20	
D030	●	2525 3C-R ZT-D	25	25	3	22	25	150	0,755		TC134 M6x20	5 Allen
D036	●	2020 4C-R ZT-D	20	20	4	18	20	125	0,400	ZT.D 4C ZCC	TC132 M5x20	4 Allen
D038	●	2525 4C-R ZT-D	25	25	4	22	25	150	0,747		TC134 M6x20	5 Allen
D044	●	2020 5C-R ZT-D	20	20	5	18	20	125	0,391	ZT.D 5C ZCC	TC132 M5x20	4 Allen
D046	●	2525 5C-R ZT-D	25	25	5	18	25	150	0,734		TC134 M6x20	5 Allen
D049	●	2525 6C-R ZT-D	25	25	6	18	25	150	0,745	ZT.D 6C ZCC	TC134 M6x20	5 Allen
D051	●	3232 6C-R ZT-D	32	32	6	20	32	170	1,331			

ZCC ucuna uygundur. / Compatible with ZCC insert. / Kompatible für ZCC WP

TKT /R TD

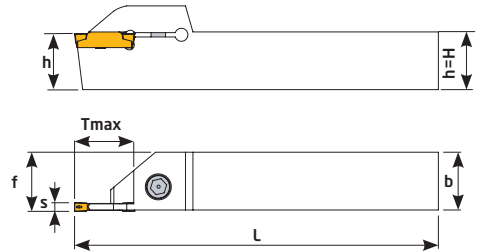

Sipariş Kodu Order Code Best.-Nr.	Stok/Stock/Lager	Ürün Kodu Product Code Produkt-Code	Ölçüler (mm) Dimensions(mm) Abmessungen (mm)							Kullanılan Uç Insert WSP	Sıkma Civatası Clamp Screw Inbuss-Schraube	Anahtar Allen Key Inbuss-Schlüssel
			h=H	b	S	Tmax	f	L	kg			
D714	●	1212 2C-R TD	12	12	2	16	12	125	0,166	TD 2C TGTC	TC131 M5x16	4 Allen
D715	●	1616 2C-R TD	16	16	2	16	16	125	0,270		TC132 M5x20	
D717	●	2525 2C-R TD	25	25	2	18	25	150	0,728		TC134 M6x20	5 Allen
D718	●	1212 3C-R TD	12	12	2	16	12	125	0,160	TD 3C TGTC	TC131 M5x16	4 Allen
D719	●	1616 3C-R TD	16	16	3	18	16	125	0,256		TC132 M5x20	
D720	●	2020 3C-R TD	20	20	3	18	20	125	0,398		TC134 M6x20	5 Allen
D721	●	2525 3C-R TD	25	25	3	18	25	150	0,735	TD 4C TGTC	TC132 M5x20	4 Allen
D722	●	2020 4C-R TD	20	20	4	18	20	125	0,401		TC134 M6x20	5 Allen
D723	●	2525 4C-R TD	25	25	4	18	25	150	0,735			

TGTC ucuna uygundur. / Compatible with TGTC insert. / Kompatible für TGTC WP

● Stokta/ In Stock/ Lager ○ Sınırlı Stok/ Limited Stock/ Begrenzte Lagerhaltung

Kalite için Teknik Çözüm | Technical Solution For Quality



www.teknikcuttingtools.com

K-HRN/R S224

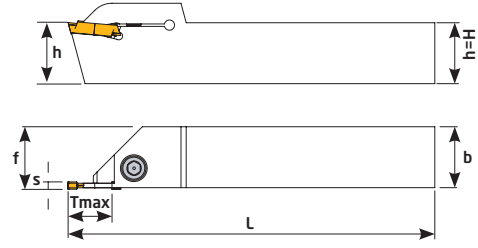

Sipariş Kodu Order Code Best.-Nr.	Stok/Stock/Lager	Ürün Kodu Product Code Produkt-Code	Ölçüler (mm) Dimensions(mm) Abmessungen (mm)							Kullanılan Uç Insert WSP	Sıkma Civatası Clamp Screw Inbuss-Schraube	Anahtar Allen Key Inbuss-Schlüssel
			h=H	b	S	Tmax	f	L				
D700	●	1616 2C-R S224	16	16	2	18	16	125	0,258	2C S224 K-HRN	TC131 M5x16	4 Allen
D701	●	2020 2C-R S224	20	20	2	18	20	125	0,406		TC132 M5x20	
D702	●	2525 2C-R S224	25	25	2	18	25	150	0,713		TC134 M6x20	5 Allen
D703	●	1616 3C-R S224	16	16	3	18	16	100	0,260	3C S224 K-HRN	TC131 M5x16	5 Allen
D704	●	2020 3C-R S224	20	20	3	18	20	125	0,407		TC132 M5x20	4 Allen
D705	●	2525 3C-R S224	25	25	3	18	25	150	0,720		TC134 M6x20	5 Allen
D706	●	2020 4C-R S224	20	20	4	18	20	125	0,401	4C S224 K-HRN	TC132 M5x20	4 Allen
D707	●	2525 4C-R S224	25	25	4	18	25	150	0,737		TC134 M6x20	5 Allen
D708	●	2020 5C-R S224	20	20	5	18	20	125	0,401	5C S224 K-HRN	TC132 M5x20	4 Allen
D710	●	2525 5C-R S224	25	25	5	18	25	150	0,730		TC134 M6x20	5 Allen

HRN ucuna uygundur. / Compatible with HRN insert. / Kompatibel für HRN WP

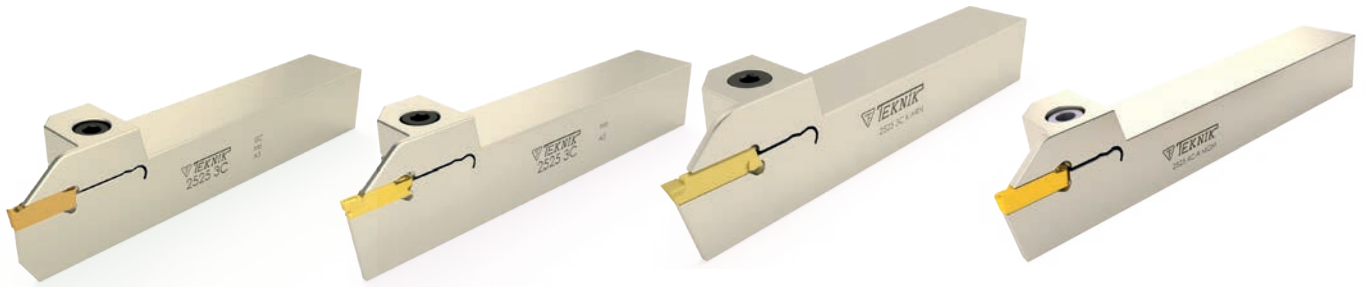

B-HRN/R S229

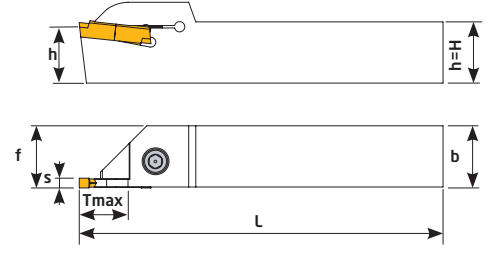

Sipariş Kodu Order Code Best.-Nr.	Stok/Stock/Lager	Ürün Kodu Product Code Produkt-Code	Ölçüler (mm) Dimensions(mm) Abmessungen (mm)							Kullanılan Uç Insert WSP	Sıkma Civatası Clamp Screw Inbuss-Schraube	Anahtar Allen Key Inbuss-Schlüssel
			h=H	b	S	Tmax	f	L	kg			
D688	●	2020 3C-R S229	20	20	3	22	20	125	0,391	3C S229 B-HRN	TC132 M5x20	4 Allen
D690	●	2525 3C-R S229	25	25	3	22	25	150	0,700		TC134 M6x20	5 Allen
D692	●	2020 4C-R S229	20	20	4	22	20	125	0,386	4C S229 B-HRN	TC132 M5x20	4 Allen
D694	●	2525 4C-R S229	25	25	4	22	25	150	0,705		TC134 M6x20	5 Allen
D696	●	2020 5C-R S229	20	20	5	22	20	125	0,389	5C S229 B-HRN	TC132 M5x20	4 Allen
D698	●	2525 5C-R S229	25	25	5	22	25	150	0,709		TC134 M6x20	5 Allen

B-HRN/L S229

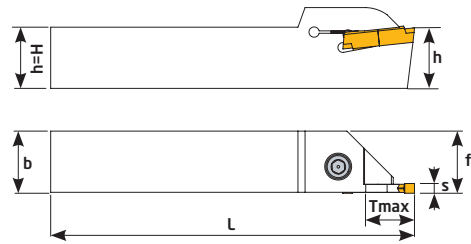

Sipariş Kodu Order Code Best.-Nr.	Stok/Stock/Lager	Ürün Kodu Product Code Produkt-Code	Ölçüler (mm) Dimensions(mm) Abmessungen (mm)							Kullanılan Uç Insert WSP	Sıkma Civatası Clamp Screw Inbuss-Schraube	Anahtar Allen Key Inbuss-Schlüssel
			h=H	b	S	Tmax	f	L	kg			
D711	●	2525 3C-L S229	25	25	3	22	25	150	0,700	3C S229 B-HRN	TC134 M6x20	5 Allen
D712	●	2525 4C-L S229	25	25	4	22	25	150	0,705	4C S229 B-HRN		
D713	●	2525 5C-L S229	25	25	5	22	25	150	0,709	5C S229 B-HRN		

HRN ucuna uygundur. / Compatible with HRN insert. / Kompatibel für HRN WP

● Stokta/In Stock/Lager ○ Sınırlı Stok/Limited Stock/Begrenzte Lagerhaltung

Kalite için Teknik Çözüm | Technical Solution For Quality



www.teknikcuttingtools.com

245

SDV 123-R

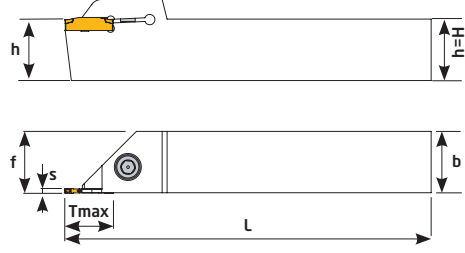

Sipariş Kodu Order Code Best.-Nr.	Stok/Stock/Lager	Ürün Kodu Product Code Produkt-Code	Ölçüler (mm) Dimensions(mm) Abmessungen (mm)							Kullanılan Uç Insert WSP	Sıkma Civatası Clamp Screw Inbuss-Schraube	Anahtar Allen Key Inbuss-Schlüssel
			h=H	b	S	Tmax	f	L				
D900	●	2020 2C-123 SDV-R	20	20	2	18	20	125	0,400	123 2C SDV	TC132 M5x20	4 Allen
D902	●	2525 2C-123 SDV-R	25	25	2	18	25	150	0,732		TC134 M6x20	5 Allen
D904	●	2020 3C-123 SDV-R	20	20	3	19	20	125	0,397	123 3C SDV	TC132 M5x20	4 Allen
D906	●	2525 3C-123 SDV-R	25	25	3	20	25	150	0,713		TC134 M6x20	5 Allen
D908	●	2020 4C-123 SDV-R	20	20	4	18	20	125	0,415	123 4C SDV	TC132 M5x20	4 Allen
D910	●	2525 4C-123 SDV-R	25	25	4	18	25	150	0,724		TC134 M6x20	5 Allen
D912	●	2525 5C-123 SDV-R	25	25	5	18	25	150	0,725	123 5C SDV	TC134 M6x20	5 Allen

SNDVK ucuna uygundur. / Compatible with SNDVK insert. / Kompatibel für SNDVK WP

SDV 123-L

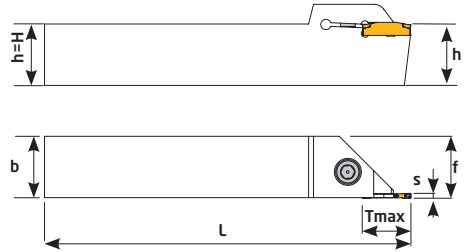

Sipariş Kodu Order Code Best.-Nr.	Stok/Stock/Lager	Ürün Kodu Product Code Produkt-Code	Ölçüler (mm) Dimensions(mm) Abmessungen (mm)							Kullanılan Uç Insert WSP	Sıkma Civatası Clamp Screw Inbuss-Schraube	Anahtar Allen Key Inbuss-Schlüssel
			h=H	b	S	Tmax	f	L				
D873	○	2020 2C-123 SDV-L	20	20	2	18	20	125	0,400	123 2C SDV	TC132 M5x20	4 Allen
D874	○	2525 2C-123 SDV-L	25	25	2	18	25	150	0,732		TC134 M6x20	5 Allen
D875	○	2020 3C-123 SDV-L	20	20	3	19	20	125	0,397	123 3C SDV	TC132 M5x20	4 Allen
D876	○	2525 3C-123 SDV-L	25	25	3	20	25	150	0,713		TC134 M6x20	5 Allen
D877	○	2020 4C-123 SDV-L	20	20	4	18	20	125	0,415	123 4C SDV	TC132 M5x20	4 Allen
D878	○	2525 4C-123 SDV-L	25	25	4	18	25	150	0,724		TC134 M6x20	5 Allen
D879	○	2525 5C-123 SDV-L	25	25	5	18	25	150	0,725	123 5C SDV	TC134 M6x20	5 Allen

SNDVK ucuna uygundur. / Compatible with SNDVK insert. / Kompatibel für SNDVK WP

● Stokta/In Stock/Lager ○ Sınırlı Stok/Limited Stock/Begrenzte Lagerhaltung



DGM 2-3

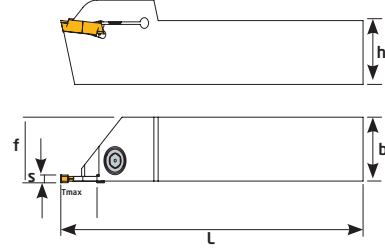

Sipariş Kodu Order Code Best.-Nr.	Stok/Stock/Lager	Ürün Kodu Product Code Produkt-Code	Ölçüler (mm) Dimensions(mm) Abmessungen (mm)							Kullanılan Uç Insert WSP	Sıkma Cıvatası Clamp Screw Inbuss-Schraube	Anahtar Allen Key Inbuss-Schlüssel
			h=H	b	S	Tmax	f	L				
D842	●	1212 2C-DGM 2	12	12	2	16	12	125	0,166		TC131 M5x16	4 Allen
D843	●	1616 2C-DGM 2	16	16	2	17	16	125	0,267			
D844	●	2020 2C-DGM 2	20	20	2	17	20	125	0,403		TC132 M5x20	5 Allen
D845	●	2525 2C-DGM 2	25	25	2	17	25	150	0,739			
D847	●	1212 3C-DGM 3	12	12	3	16	12	125	0,168		TC132 M5x20	4 Allen
D848	●	1616 3C-DGM 3	16	16	3	17	16	125	0,263			
D849	●	2020 3C-DGM 3	20	20	3	20	20	125	0,395		TC134 M6x20	5 Allen
D850	●	2525 3C-DGM 3	25	25	3	20	25	150	0,740			

TNGLY ucuna uygundur. / Compatible with TNGLY insert. / Kompatible für TNGLY WP

GX16-GX24

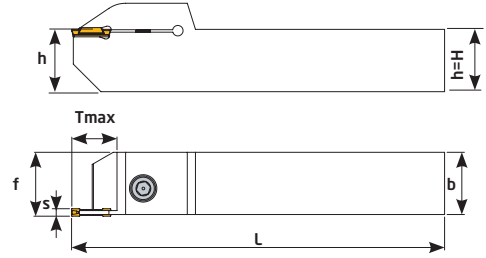

Sipariş Kodu Order Code Best.-Nr.	Stok/Stock/Lager	Ürün Kodu Product Code Produkt-Code	Ölçüler (mm) Dimensions(mm) Abmessungen (mm)							Kullanılan Uç Insert WSP	Sıkma Cıvatası Clamp Screw Inbuss-Schraube	Anahtar Allen Key Inbuss-Schlüssel
			h=H	b	S	Tmax	f	L				
D858	●	2020 2C GX16	20	20	2	18	20	125	0,267		TC132 M5x20	4 Allen
D859	●	2525 2C GX16	25	25	2	18	25	150	0,403			
D860	●	2020 3C GX16	20	20	3	20	20	125	0,395		TC132 M5x20	4 Allen
D861	●	2525 3C GX16	25	25	3	22	25	150	0,740			
D864	●	2020 2C GX24	20	20	2	18	20	125	0,403		TC132 M5x20	4 Allen
D865	●	2525 2C GX24	25	25	2	18	25	150	0,739			
D866	●	2020 3C GX24	20	20	3	20	20	125	0,395		TC132 M5x20	4 Allen
D867	●	2525 3C GX24	25	25	3	22	25	150	0,740			

WLTR ucuna uygundur. / Compatible with WLTR insert. / Kompatible für WLTR WP

● Stokta/ In Stock/ Lager ○ Sınırlı Stok/ Limited Stock/ Begrenzte Lagerhaltung

MGMN

NEW
PRODUCT

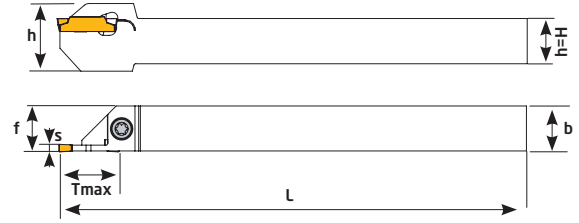

Sipariş Kodu Order Code Best.-Nr.	Stok / Stock / Lager	Ürün Kodu Product Code Produkt-Code	Ölçüler (mm) Dimensions (mm) Abmessungen (mm)							Kullanılan Uç Insert WSP	Sıkma Civatası Clamp Screw Inbuss-Schraube	Anahtar Allen Key Inbuss-Schlüssel
			h=H	b	S	Tmax	f	L	kg			
D010	●	1212 2C MGMN 200	12	12	2	12	12,2	125	MGMN 200 KRLY	TC074 M4x10	T15	
D011	●	1616 2C MGMN 200	16	16	2	16	16,2	125				
D013	●	1212 3C MGMN 300	12	12	3	12	12,3	125	MGMN 300 KRLY	TC074 M4x10	T15	
D014	●	1616 3C MGMN 300	16	16	3	16	16,3	125				

KRLY ucuna uygundur. / Compatible with KRLY insert. / Kompatibel für KRLY WP

KGMN

NEW
PRODUCT

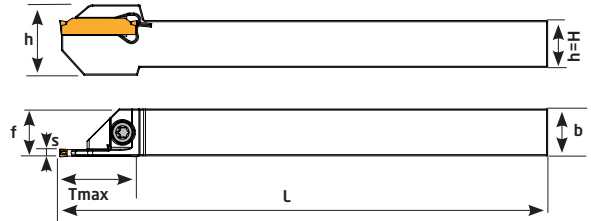

Sipariş Kodu Order Code Best.-Nr.	Stok / Stock / Lager	Ürün Kodu Product Code Produkt-Code	Ölçüler (mm) Dimensions (mm) Abmessungen (mm)							Kullanılan Uç Insert WSP	Sıkma Civatası Clamp Screw Inbuss-Schraube	Anahtar Allen Key Inbuss-Schlüssel
			h=H	b	S	Tmax	f	L	kg			
D016	●	1212 2C KGMN 200	12	12	2	12	12,2	125	KGMN 200 KRLY	TC074 M4x10	T15	
D017	●	1616 2C KGMN 200	16	16	2	16	16,2	125				

KRLY ucuna uygundur. / Compatible with KRLY insert. / Kompatibel für KRLY WP



DGN

NEW
PRODUCT

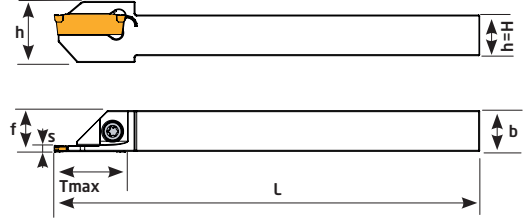

Sipariş Kodu Order Code Best.-Nr.	Stok/Stock/Lager	Ürün Kodu Product Code Produkt-Code	Ölçüler (mm) Dimensions(mm) Abmessungen (mm)							Kullanılan Uç Insert WSP	Sıkma Civatası Clamp Screw Inbuss-Schraube	Anahtar Allen Key Inbuss-Schlüssel
			h=H	b	S	Tmax	f	L				
D019	●	1212 2C DGN	12	12	2	12	12,2	125		DGN 2C ISCR	TC074 M4x10	T15
D020	●	1616 2C DGN	16	16	2	16	16,2	125				
D021	●	1212 3C-DGM	12	12	3	12	12,3	125		DGN 3C ISCR	TC074 M4x10	T15
D022	●	1616 3C-DGN	16	16	3	16	16,3	125				

ISCR ucuna uygundur. / Compatible with ISCR insert. / Kompatible für ISCR WP

MGMN	Sipariş Kodu Order Code Best.-Nr.	Sipariş Kodu Order Code Best.-Nr.	Ölçüler (mm) Dimensions(mm) Abmessungen (mm)					Kullanılan Uç Insert WSP
			H	h	A	L	D max	
			KL29	32-2	32	25	2	
KL30	32-3	32	25	2,45	150	36	MGMN 300 KRLY	
KL32	32-4	32	25	3,45	150	36	MGMN 400 KRLY	

KGMN	Sipariş Kodu Order Code Best.-Nr.	Sipariş Kodu Order Code Best.-Nr.	Ölçüler (mm) Dimensions(mm) Abmessungen (mm)					Kullanılan Uç Insert WSP
			H	h	A	L	D max	
			KL37	26-2	26	21,4	1,65	
KL38	26-3	26	21,4	2,45	110	36	KGMN 300 KRLY	
KL39	26-4	26	21,4	3,45	110	36	KGMN 400 KRLY	
KL34	32-2	32	25	1,65	150	36	KGMN 200 KRLY	
KL35	32-3	32	25	2,45	150	36	KGMN 300 KRLY	
KL36	32-4	32	25	3,45	150	36	KGMN 400 KRLY	

SP	Sipariş Kodu Order Code Best.-Nr.	Sipariş Kodu Order Code Best.-Nr.	Ölçüler (mm) Dimensions(mm) Abmessungen (mm)					Kullanılan Uç Insert WSP
			H	h	A	L	D max	
			KL40	26-3	26	21,4	2,45	
KL42	26-4	26	21,4	3,45	110		SP 400 KRLY	
KL44	32-3	32	25	2,45	150		SP 300 KRLY	
KL45	32-4	32	25	3,45	150		SP 400 KRLY	



N151-3	Sipariş Kodu Order Code Best.-Nr.	Sipariş Kodu Order Code Best.-Nr.	Ölçüler (mm) Dimensions(mm) Abmessungen (mm)					Kullanılan Uç Insert WSP
			H	h	A	L	D max	
			KL52	26-3	26	21,4	2,45	
KL54	26-4	26	21,4	3,45	110		N151-4 SDV	
KL56	32-3	32	25	2,45	150		N151-3 SDV	
KL58	32-4	32	25	3,45	150		N151-4 SDV	

SDV 123	Sipariş Kodu Order Code Best.-Nr.	Sipariş Kodu Order Code Best.-Nr.	Ölçüler (mm) Dimensions(mm) Abmessungen (mm)					Kullanılan Uç Insert WSP
			H	h	A	L	D max	
			KL60	32-3	32	25	2,45	
KL61	32-4	32	25	3,45	150		123 4C SDV	

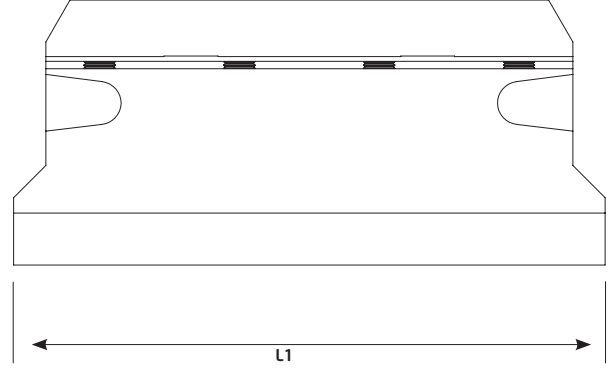
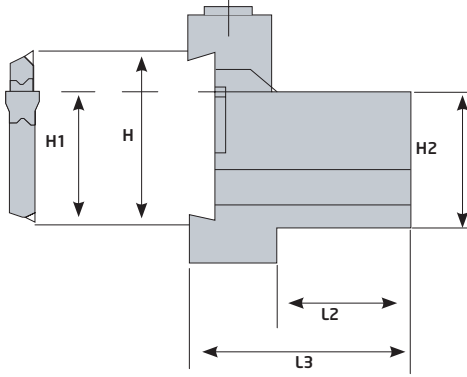

KESKİ KÜTÜĞÜ
Block for Blades

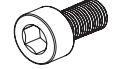

Sipariş Kodu Order Code Best.-Nr.	Stok/Stok/Lager	Ürün Kodu Product Code Produkt-Code	Ölçüler (mm) Dimensions(mm) Abmessungen (mm)						Papuç Clamp Spannpratze	Sıkma Civatası Clamp Screw Inbuss-Schraube	Anahtar Allen Key Inbuss-Schlüssel
			H	L1	L2	H1	H2	L3			
KLT04	●	20-26	26	87	19	21,4	20	33	KLT19	TC135 M6x30	5 Allen
KLT05	●	25-26	26	110	20	24,4	25	34	KLT18	TC135 M6x30	5 Allen
KLT06	●	20-32	32	110	19	25	20	35	KLT20	TC135 M6x30	5 Allen
KLT08	●	25-32	32	110	20	25	25	36	KLT20	TC135 M6x30	5 Allen
KLT10	●	32-32	32	110	28	25	32	44	KLT20	TC135 M6x30	5 Allen

● Stokta/ In Stock/ Lager ○ Sınırlı Stok/ Limited Stock/ Begrenzte Lagerhaltung

Kalite için Teknik Çözüm | Technical Solution For Quality

BROTECH

TEKNİK
Cutting Tools

www.teknikcuttingtools.com

251

Kalite için TEKNIK çözüm
Technical solution for quality



THE TEKNIK MAKİNA®
EXCEPTIONAL CUTTING TOOLS
COLLECTION

www.teknikmakinatakim.com

www.teknikcuttingtools.com

İç Çap Kanal Kater
Grooving Holders
Stech-Klemmhalter



**Technical Solution
for Quality**



KRLY/R

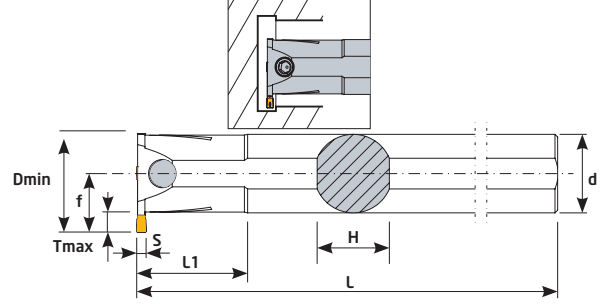

Sipariş Kodu Order Code Best.-Nr.	Stok/Stock/Lager	Ürün Kodu Product Code Produkt-Code	Ölçüler (mm) Dimensions(mm) Abmessungen (mm)									Kullanılan Uç Insert WSP	Sıkma Civatası Clamp Screw Inbuss-Schraube	Anahtar Allen Key Inbuss-Schlüssel
			Dmin	Tmax	L	L1	d	h	f	s	kg			
K600	●	S16Q 2C-R MGM	21	5	180	35	16	15	12,5	2	0,288	MGM 200 KRLY	TC130 M5x12	4 Allen
K602	●	S20Q 2C-R MGM	26	5,7	180	35	20	18	15,5	2	0,440			
K603	●	S25R 2C-R MGM	31	5,7	200	35	25	23	18	2	0,787		TC130 M5x12	
K604	●	S20Q 3C-R MGM	26	6	180	35	20	18	15,5	3	0,450	MGM 300 KRLY	TC131 M5x16	
K606	●	S25R 3C-R MGM	32	6,7	200	40	25	23	19	3	0,784		TC134 M6x20	
K608	●	S32S 3C-R MGM	38	6,1	250	60	32	30	21,5	3	1,555		TC130 M5x12	4 Allen
K609	●	S40T 3C-R MGM	48	7,2	300	60	40	38	27	3	2,940	TC131 M5x16		
K610	●	S20Q 4C-R MGM	26	6	180	35	20	18	15,5	4	0,443	MGM 400 KRLY	TC134 M6x20	5 Allen
K612	●	S25R 4C-R MGM	31	6	200	40	25	23	18,2	4	0,783		TC130 M5x12	
K614	●	S32S 4C-R MGM	38	6	250	60	32	30	21,5	4	1,552		TC131 M5x16	
K616	●	S40T 4C-R MGM	47	7,2	300	60	40	38	27	4	2,942	TC134 M6x20	4 Allen	
K618	●	S25R 5C-R MGM	32	7	200	40	25	23	19,2	5	0,777	TC131 M5x16		
K620	●	S32S 5C-R MGM	39	7	250	60	32	30	22,5	5	1,561	MGM 500 KRLY	TC134 M6x20	5 Allen
K622	●	S40T 5C-R MGM	47	7,4	300	60	40	38	27	5	2,936			

KGMN

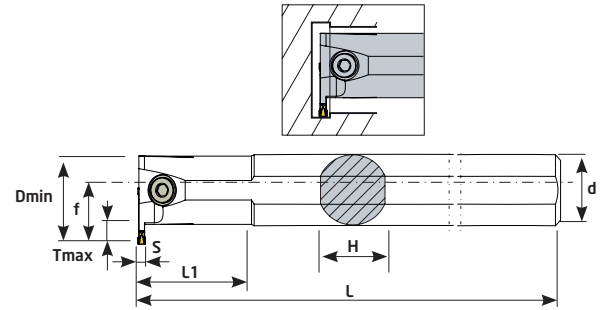

Sipariş Kodu Order Code Best.-Nr.	Stok/Stock/Lager	Ürün Kodu Product Code Produkt-Code	Ölçüler (mm) Dimensions(mm) Abmessungen (mm)									Kullanılan Uç Insert WSP	Sıkma Civatası Clamp Screw Inbuss-Schraube	Anahtar Allen Key Inbuss-Schlüssel
			Dmin	Tmax	L	L1	d	h	f	s	kg			
K660	●	S16K 2C KGMN	23	6,5	125	35	16	15	14	2	0,220	KGMN 200 KRLY	TC130 M5x12	4 Allen
K661	●	S20M 2C KGMN	25	6,5	150	45	20	18	15,5	2	0,374			
K662	●	S25R 2C KGMN	32	7	200	45	25	23	19	2	0,802		TC130 M5x12	
K663	●	S20M 3C KGMN	25	6,5	150	45	20	18	15,5	3	0,370	KGMN 300 KRLY	TC131 M5x16	
K664	●	S25R 3C KGMN	32	7	200	45	25	23	19	3	0,800		TC134 M6x20	
K665	●	S32S 3C KGMN	40	7,5	250	55	32	30	22,5	3	1,627		TC130 M5x12	4 Allen
K666	●	S20M 4C KGMN	25	6,5	150	45	20	18	15,5	4	0,374	TC131 M5x16		
K667	●	S25R 4C KGMN	32	7	200	45	25	23	19	4	0,796	KGMN 400 KRLY	TC134 M6x20	5 Allen
K668	●	S32S 4C KGMN	40	7,5	250	55	32	30	22,5	4	1,623			

KRLY ucuna uygundur. / Compatible with KRLY insert. / Kompatibel für KRLY WP

● Stokta/In Stock/Lager ○ Sınırlı Stok/Limited Stock/Begrenzte Lagerhaltung



HRN/R S229

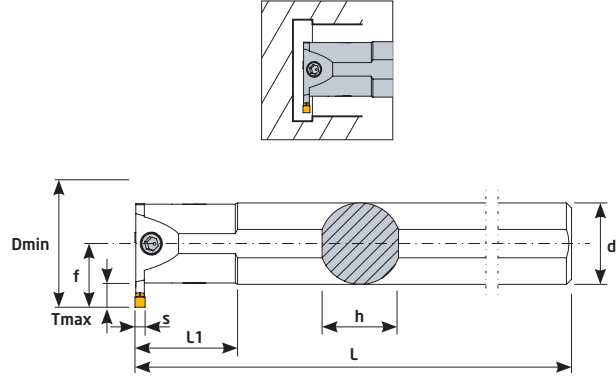

Sipariş Kodu Order Code Best.-Nr.	Stok/Stock/Lager	Ürün Kodu Product Code Produkt-Code	Ölçüler (mm) Dimensions(mm) Abmessungen (mm)									Kullanılan Uç Insert WSP	Sıkma Civatası Clamp Screw Inbuss-Schraube	Anahtar Allen Key Inbuss-Schlüssel
			Dmin	Tmax	L	L1	d	h	f	s	kg			
K624	●	S25R 3C-R S229	34	9,8	200	50	25	23	21,5	3	0,766	3C S229 B.HRN	TC131 M5x16	4 Allen
K626	●	S32S 3C-R S229	41	9	250	50	32	30	24,5	3	1,560		TC134 M6x20	5 Allen
K628	●	S40T 3C-R S229	49	9	300	50	40	38	28,5	3	2,594			
K630	●	S25R 4C-R S229	34	9,8	200	50	25	23	21,5	4	0,768	4C S229 B.HRN	TC131 M5x16	4 Allen
K632	●	S32S 4C-R S229	42	9	250	50	32	30	24,7	4	1,656		TC134 M6x20	5 Allen
K634	●	S40T 4C-R S229	49	9	300	50	40	38	28,5	4	3,113			
K636	●	S25R 5C-R S229	33	9,5	200	50	25	23	21,1	5	0,770	5C S229 B.HRN	TC131 M5x16	4 Allen
K638	●	S32S 5C-R S229	41	9	250	50	32	30	24,7	5	1,659		TC134 M6x20	5 Allen
K640	●	S40T 5C-R S229	49	9	300	50	40	38	28,5	5	3,109			

HRN ucuna uygundur. / Compatible with HRN insert. / Kompatibel für HRN WP

SDV/R 123

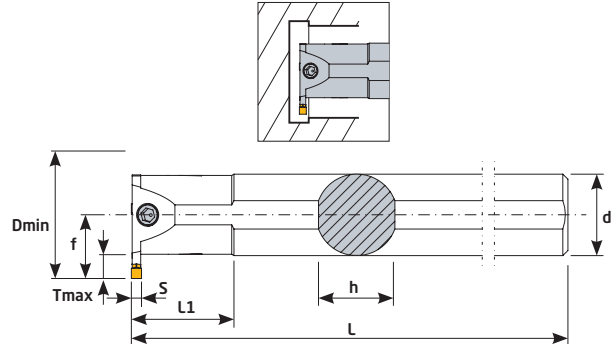

Sipariş Kodu Order Code Best.-Nr.	Stok/Stock/Lager	Ürün Kodu Product Code Produkt-Code	Ölçüler (mm) Dimensions(mm) Abmessungen (mm)									Kullanılan Uç Insert WSP	Sıkma Civatası Clamp Screw Inbuss-Schraube	Anahtar Allen Key Inbuss-Schlüssel
			Dmin	Tmax	L	L1	d	h	f	s	kg			
K720	●	S25R 3C-R-123 SDV	32	7	200	40	25	23	19,2	3	0,784	123 3C SNDVK	TC131 M5x16	4 Allen
K722	●	S32S 3C-R-123 SDV	39	7	250	60	32	30	22,7	3	1,567		TC134 M6x20	5 Allen
K726	●	S25R 4C-R-123 SDV	32	7	200	40	25	23	19,5	4	0,772	123 4C SNDVK	TC131 M5x16	4 Allen
K728	●	S32S 4C-R-123 SDV	39	7	250	60	32	30	22,5	4	2,854		TC134 M6x20	5 Allen
K730	●	S25S 5C-R-123 SDV	32	7	200	40	25	23	19,2	5	0,785	123 5C SNDVK	TC131 M5x16	4 Allen
K732	●	S32S 5C-R-123 SDV	39	7	250	60	32	30	22,7	5	1,564		TC134 M6x20	5 Allen

SNDVK ucuna uygundur. / Compatible with SNDVK insert. / Kompatibel für SNDVK WP

● Stokta/ In Stock/ Lager ○ Sınırlı Stok/ Limited Stock/ Begrenzte Lagerhaltung

Kalite için Teknik Çözüm | Technical Solution For Quality



www.teknikcuttingtools.com

255

HRN/R S224

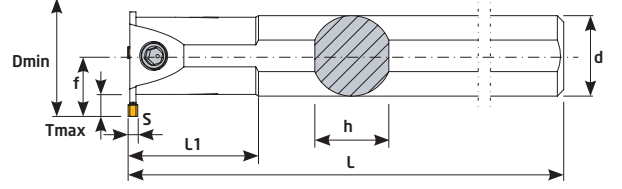
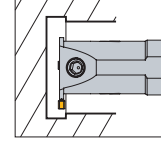

Sipariş Kodu Order Code Best.-Nr.	Stok/Stock/Lager	Ürün Kodu Product Code Produkt-Code	Ölçüler (mm) Dimensions(mm) Abmessungen (mm)									Kullanılan Uç Insert WSP	Sıkma Civatası Clamp Screw Inbuss-Schraube	Anahtar Allen Key Inbuss-Schlüssel
			Dmin	Tmax	L	L1	d	h	f	S	kg			
K642	●	S20Q 2C-R S224	26	6,5	180	40	20	18	16	2	0,444	S224 2C K.HRN	TC130 M5x12 TC131 M5x16	4 Allen
K644	●	S25R 2C-R S224	34	9	200	50	25	23	21,2	2	0,763			
K646	●	S20Q 3C-R S224	26	6,5	180	40	20	18	16	3	0,459	S224 3C K.HRN	TC130 M5x12 TC131 M5x16	
K648	●	S25R 3C-R S224	33	9	200	50	25	23	20,6	3	0,782			
K650	●	S32S 3C-R S224	40	9	250	50	32	30	24,1	3	1,633	S224 4C K.HRN	TC130 M5x12 TC131 M5x16	5 Allen
K652	●	S20Q 4C-R S224	26	6,5	180	40	20	18	16	4	0,440			4 Allen
K654	●	S25R 4C-R S224	33	9	200	50	25	23	20,6	4	0,764	S224 4C K.HRN	TC130 M5x12 TC131 M5x16	5 Allen
K656	●	S32S 4C-R S224	42	9	250	50	32	30	23,5	4	1,672			4 Allen

HRN ucuna uygundur. / Compatible with HRN insert. / Kompatibel für HRN WP

ZCC/R ZT.D

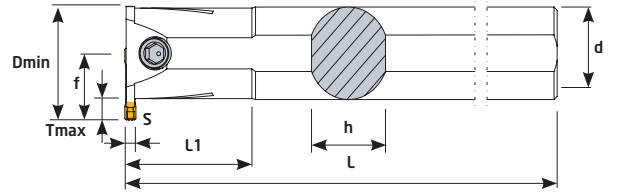
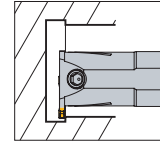

Sipariş Kodu Order Code Best.-Nr.	Stok/Stock/Lager	Ürün Kodu Product Code Produkt-Code	Ölçüler (mm) Dimensions(mm) Abmessungen (mm)									Kullanılan Uç Insert WSP	Sıkma Civatası Clamp Screw Inbuss-Schraube	Anahtar Allen Key Inbuss-Schlüssel
			Dmin	Tmax	L	L1	d	h	f	S	kg			
K679	●	S16Q 2C R ZT.D	20	4,9	180	35	16	15	12,5	2	0,446	ZT.D 2C ZCC	TC130 M5x12	4 Allen
K680	●	S20Q 3C-R ZT.D	26	5,5	180	35	20	18	15,2	3	0,661			
K681	●	S25R 3C-R ZT.D	33	7,5	200	35	25	23	19,7	3	1,576	ZT.D 3C ZCC	TC131 M5x16	4 Allen
K682	●	S32S 3C-R ZT.D	39	7	250	50	32	30	22,7	3	1,641			
K684	●	S25R 4C-R ZT.D	33	7,5	200	35	25	23	19,7	4	1,578	ZT.D 4C ZCC	TC130 M5x16	4 Allen
K685	●	S32S 4C-R ZT.D	39	7	250	50	32	30	22,7	4	1,645			

ZCC ucuna uygundur. / Compatible with ZCC insert. / Kompatibel für ZCC ZCC WP



GRP/R

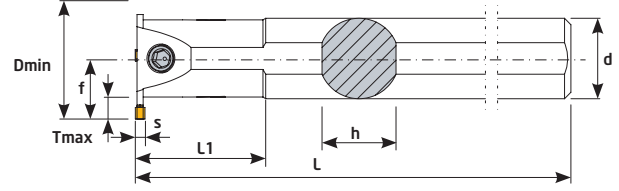
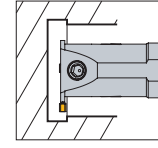

Sipariş Kodu Order Code Best.-Nr.	Stok/Stock/Lager	Ürün Kodu Product Code Produkt-Code	Ölçüler (mm) Dimensions(mm) Abmessungen (mm)										Kullanılan Uç Insert WSP	Sıkma Civatası Clamp Screw Inbuss-Schraube	Anahtar Allen Key Inbuss-Schlüssel
			Dmin	Tmax	L	L1	d	h	f	S	kg				
K700	●	S16Q 3C-R GRP	21	4,9	180	45	16	18	12,5	3	0,308	GRP 3C ISCR	TC130 M5x12	4 Allen	
K702	●	S20Q 3C-R GRP	26	6	180	35	20	18	15,7	3	0,463				
K704	●	S25R 3C-R GRP	32	6,5	200	35	25	23	18,7	3	0,809		GRP 4C ISCR	TC131 M5x16	4 Allen
K706	●	S20Q 4C-R GRP	26	5,5	180	35	20	18	15,2	4	0,463				
K708	●	S25R 4C-R GRP	32	6,5	200	35	25	23	18,7	4	0,810	TC134 M6x20		5 Allen	
K710	●	S32S 4C-R GRP	38	6,5	250	60	32	30	22	4	1,655				

ISCR ucuna uygundur. / Compatible with ISCR insert. / Kompatible für ISCR WP

DGN/R

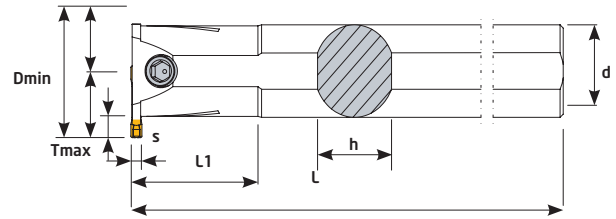
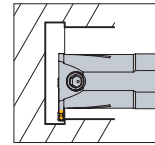

Sipariş Kodu Order Code Best.-Nr.	Stok/Stock/Lager	Ürün Kodu Product Code Produkt-Code	Ölçüler (mm) Dimensions(mm) Abmessungen (mm)										Kullanılan Uç Insert WSP	Sıkma Civatası Clamp Screw Inbuss-Schraube	Anahtar Allen Key Inbuss-Schlüssel
			Dmin	Tmax	L	L1	d	h	f	S	kg				
K672	●	S20Q 3C-R DGN	25	5,5	180	35	20	18	15	3	0,446	DGN 3C ISCR	TC130 M5x12	4 Allen	
K673	●	S25R 3C-R DGN	31	6	200	40	25	23	18,2	3	0,798				
K674	●	S32S 3C-R DGN	37	6	250	55	32	30	30	3	1,620		DGN 4C ISCR	TC131 M5x16	5 Allen
K676	●	S20Q 4C-R DGN	25	5,5	180	35	20	18	18	4	0,461				
K677	●	S25R 4C-R DGN	31	6	200	40	25	23	23	4	0,802	TC134 M6x20		5 Allen	
K678	●	S32S 4C-R DGN	37	6	250	55	32	30	30	4	1,648				

ISCR ucuna uygundur. / Compatible with ISCR insert. / Kompatible für ISCR WP

● Stokta/ In Stock/ Lager ○ Sınırlı Stok/ Limited Stock/ Begrenzte Lagerhaltung

Kalite için Teknik Çözüm | Technical Solution For Quality



www.teknikcuttingtools.com

MINI KANAL KATERİ
Mini Grooving Bars

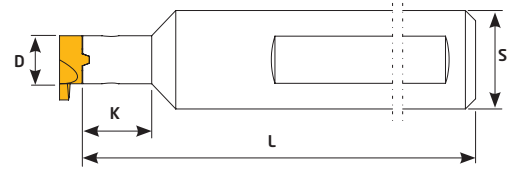

Sipariş Kodu Order Code Best.-Nr.	Stok/Stock/Lager	Ürün Kodu Product Code Produkt-Code	Ölçüler (mm) Dimensions (mm) Abmessungen (mm)					Kullanılan Uç Insert WSP	Sıkma Civatası Clamp Screw Torx-Schraube	Anahtar Torx Key Torx-Schlüssel
			S	D	K	L	KG			
K801	●	S12 D5,9 K24 L080	12	5,9	24	80	0,143	NFTG 08 KRLY	TC063 M2,5x7	T8
K802	●	S12 D08 K33 L095	12	8	33	95	0,126	NFTG 11 KRLY	TC069 M3,5x8,5	T10
K803	●	S12 D09 K45 L110	12	9	45	110	0,120	NFTG 14 KRLY	TC074 M4x10	T15
K804	●	S12 D11 K48 L130	12	11	48	130	0,348	NFTG 16 KRLY	TC085 M5x12	T20

KRLY ucuna uygundur. / Compatible with KRLY insert. / Kompatibel für KRLY WP

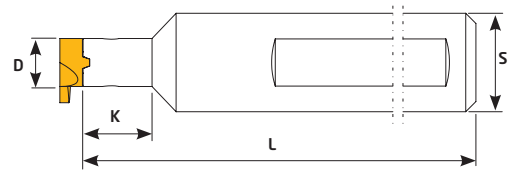
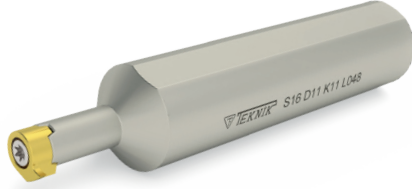

Sipariş Kodu Order Code Best.-Nr.	Stok/Stock/Lager	Ürün Kodu Product Code Produkt-Code	S	D	K	L	KG	Kullanılan Uç Insert WSP	Sıkma Civatası Clamp Screw Torx-Schraube	Anahtar Torx Key Torx-Schlüssel
K812	●	S16 D09 K20 L093	16	9	20	93	0,102	D09	TC074 M4x10	T15
K814	●	S16 D06 K11 L081	16	6	11	81	0,082	D06	TC063 M2,5x7	T8
K816	●	S20 D14 K49 L160	20	14	49	160	0,367	D14	TC085 M5x12	T20

HRN ucuna uygundur. / Compatible with HRN insert. / Kompatibel für HRN WP

MINI TOOL

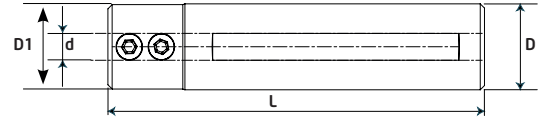

Sipariş Kodu Order Code Best.-Nr.	Stok/Stock/Lager	Ürün Kodu Product Code Produkt-Code	D	d	L	D1	KG	Sıkma Civatası Clamp Screw Torx-Schraube	Anahtar Torx Key Torx-Schlüssel
DC306	●	D20 d03 L88	20	3	88	19,65	0,228	M6x50	M6x8
DC310	●	D12 d04 L88	12	4	88	11,65	0,075	M6x50	M6x5
DC312	●	D16 d04 L75	16	4	75	19,65	0,139	M6x35	M6x8
DC314	●	D16 d04 L88	16	4	88	19,65	0,159	M6x50	M6x8
DC316	●	D20 d04 L88	20	4	88	19,65	0,222	M6x50	M6x8
DC318	●	D22 d04 L88	22	4	88	21,65	0,274	M6x50	M6x8
DC320	●	D12 d05 L88	12	5	88	11,65	0,067	M6x50	M6x5
DC322	●	D16 d05 L75	16	5	75	19,65	0,135	M6x35	M6x8
DC324	●	D16 d05 L88	16	5	88	19,65	0,153	M6x50	M6x8
DC326	●	D20 d05 L88	20	5	88	19,65	0,221	M6x50	M6x8
DC328	●	D22 d05 L88	22	5	88	21,65	0,274	M6x50	M6x8
DC334	●	D20 d06 L88	20	6	88	19,65	0,227	M6x50	M6x8
DC340	●	D20 d07 L88	20	7	88	19,65	0,219	M6x50	M6x8
DC344	●	D16 d08 L88	16	8	88	19,65	0,142	M6x50	M6x8
DC346	●	D20 d08 L88	20	8	88	19,65	0,214	M6x50	M6x5
DC350	●	D16 d10 L88	16	10	88	19,65	0,130	M6x50	M6x5
DC352	●	D20 d10 L88	20	10	88	19,65	0,201	M6x50	M6x5

● Stokta/ In Stock/ Lager ○ Sınırlı Stok/ Limited Stock/ Begrenzte Lagerhaltung



Takım Tutucuları
Tool Holders
Werkzeugaufnahmen

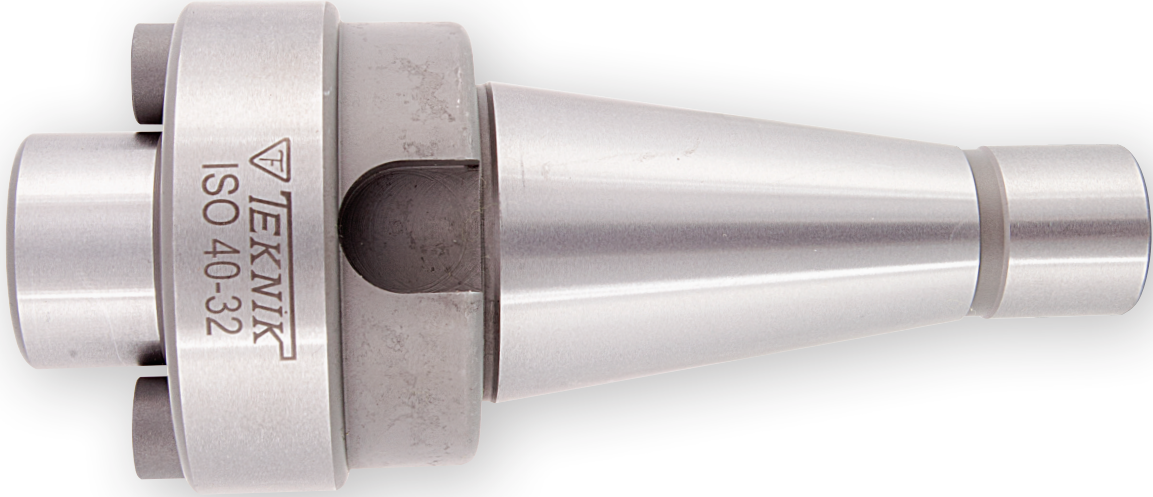

**Technical Solution
for Quality**



ISO 40

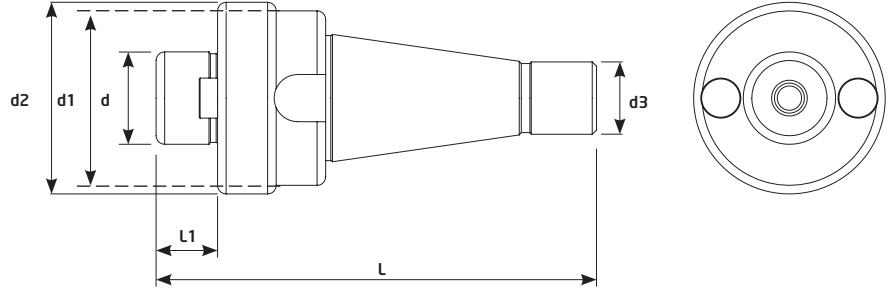

Sipariş Kodu Order Code Best.-Nr.	Stok/Stock/Lager	Ürün Kodu Product Code Produkt-Code	ŞAFT Shank Schaft	Ölçüler (mm) Dimensions(mm) Abmessungen (mm)						
				d	d1	d2	d3	L	L1	kg
M206	●	ISO 40-16	ISO 40	16	54	38	25	154	17	1,232
M208	●	ISO 40-22	ISO 40	22	54	50	25	154	19	1,371
M210	●	ISO 40-27	ISO 40	27	55	59	25	154	21	1,413
M212	●	ISO 40-32	ISO 40	32	61	67	25	154	24	1,750
M214	●	ISO 40-40	ISO 40	40	61	73	25	154	27	1,956

ISO 50

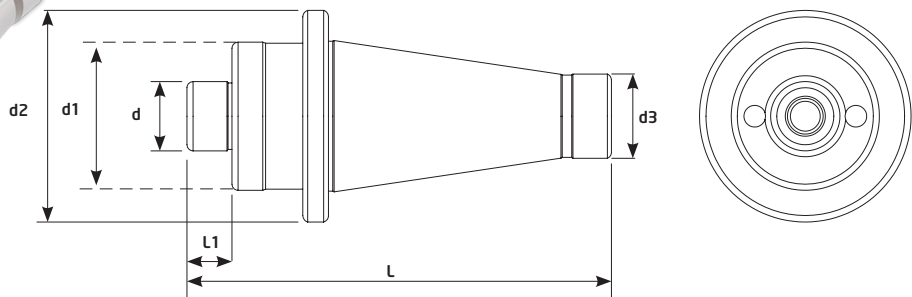

Sipariş Kodu Order Code Best.-Nr.	Stok/Stock/Lager	Ürün Kodu Product Code Produkt-Code	ŞAFT Shank Schaft	Ölçüler (mm) Dimensions(mm) Abmessungen (mm)						
				d	d1	d2	d3	L	L1	kg
M216	●	ISO 50-22	ISO 50	22	98	52	39	196	19	3,640
M218	●	ISO 50-27	ISO 50	27	98	61	39	196	21	3,976
M220	●	ISO 50-32	ISO 50	32	98	68	39	196	24	3,817
M222	●	ISO 50-40	ISO 50	40	98	98	39	196	27	4,512
M224	●	ISO 50-60	ISO 50	60	108	108	39	196	26	5,562







Yedek Parça
Spare Parts
Zubehör



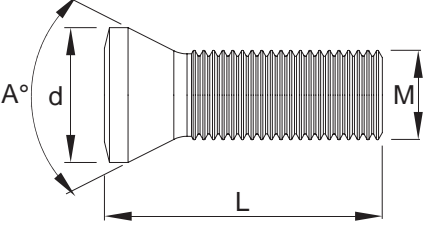

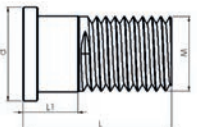





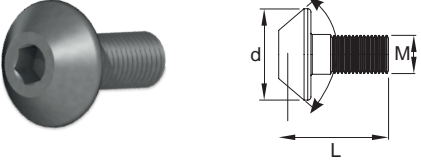

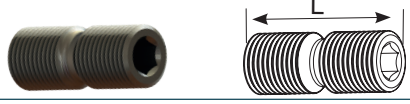
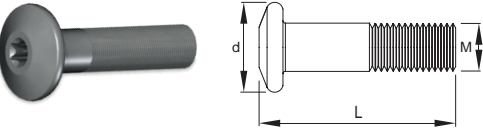
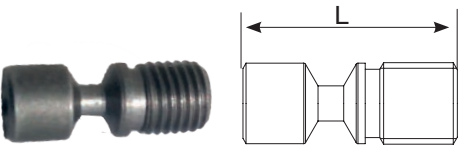
**Technical Solution
for Quality**

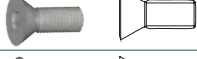

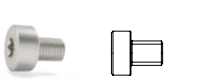



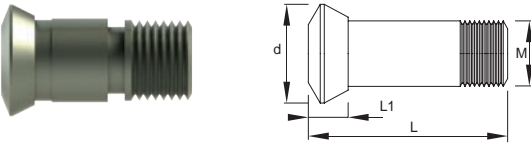





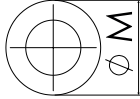



























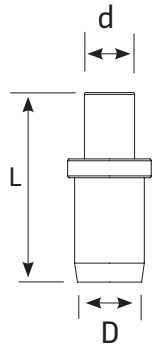



Parça/Part/Zubehör	Kod Code	M	L	d	A	Anahtar/Key Schlüssel
<p>Tork Cıvatası (Sıkma Cıvata) Torx Screw Torx Schrauben</p>  	TC057	M1,6	3,4	2,6	60°	T6
	TC057-1	M1,8	4,1	2,5	60°	T6
	TC058	M2	4,2	2,8	60°	T6
	TC058-1	M2	5	2,8	60°	T6
	TC058-2	M2,2	6	3	60°	T7
	TC059	M2,2	5	3	60°	T7
	TC059-1	M2,5	4,7	3,5	60°	T8
	TC060	M2,5	5,5	3,5	60°	T8
	TC061	M2,5	6,5	3,5	50°	T8
	TC063	M2,5	7	3,5	60°	T8
	TC092	M2,5	5,5	3,8	60°	T8
	TC093	M2,5	7	3,8	60°	T8
	TC064	M3	6,2	3,8	60°	T8
	TC065	M3	7	4,2	60°	T8
	TC065-1	M3	7	4	60°	T8
	TC066	M3	10	5,3	55°	T15
	TC067	M3,5	8,5	5,3	60°	T15
	TC068	M3,5	11	5,3	60°	T15
	TC069	M3,5	8,5	4,8	60°	T10
	TC071	M3,5	7	5,3	60°	T15
	TC072	M4	10	5,5	60°	T15
	TC073	M4	7	5,5	60°	T15
	TC074	M4	10	5,5	60°	T15
	TC075	M4	11	7	60°	T15
	TC076	M4	12,5	5,5	60°	T15
	TC077	M4	15	6,8	60°	T15
	TC078	M4	11	6,7	60°	T15
	TC079	M4	11	5,2	45°	T15
TC080	M4,5	11	6,2	60°	T15	
TC083	M5	12	7	60°	T20	
TC085	M5	12	6,6	75°	T20	
TC086	M5	18	7,5	60°	T20	
<p>Bükse Cıvata Shim Screw Inbuss-Schlüssel</p>  	TC048	M5	9	6,3		4 Allen
	TC049	M5	7,7			3,5 Allen
	TC049-1	M6	10			4 Allen





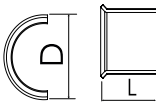





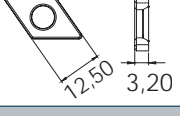

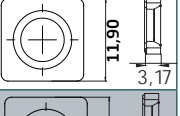



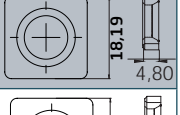

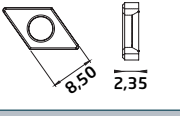

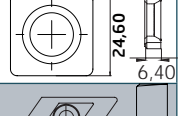





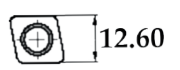

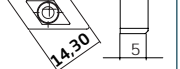

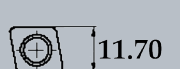

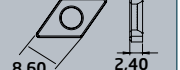

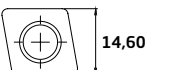







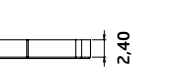







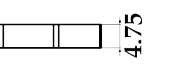







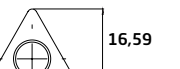









Parça/Part/Zubehör		Kod Code	M	L	d	Anahtar/Key Schlüssel
Baski Civatalar Locking Screw Verriegelungsschraub		TC050	M6	14	11,2	3 Allen
		TC052	M6	17	14	4 Allen
		TC054	M8	24	17,1	5 Allen
		TC056	M8 (sol-left)	24	17,1	5 Allen
		TC300	M8	21		4 Allen
		TC044	M6	27	11	3 Allen
		TC046	M5	26	10	3 Allen
		TC047	M8	29	13,6	5 Allen
		TH512	M5	12		2 Allen
		TH613	M6	13,4		2,5 Allen
		TH617	M6	17		2 Allen
		TH818	M8	18		3 Allen
		TH821	M8	21		3 Allen
		TH822	M8	22		2,5 Allen
TH825		M8	25		3 Allen	
Altık Civatalar Shim Screw Inbuss-Schlüssel		TC036	M3	10	5,6	T10
		TC038	M4	10	7,30	T15
		TC039	M6	12	10,6	4 Allen
		TC040	M3,5	10	8	T15
		TC062	M3	6,7	5,5	T15
		TC053	M4			T20
		TC053-1	M4			T15
		TC095	M5	12	9,5	3 Allen
Küre Civatalar Screws For Radius Cutter		TC170	M3	7	4,2	T8
		TC172	M4	9	5,8	T15
		TC174	M5	10	7	T20
		TC176	M5	12	7,3	T20
		TC178	M5	16	7,8	3 Allen
		TC181	M6	22	9,5	3 Allen
		TC184	M8	25	13	4 Allen

● Stokta/ In Stock/ Lager ○ Sınırlı Stok/ Limited Stock/ Begrenzte Lagerhaltung

Kod Code	Tipi Type	Parça Part	Ölçüler (mm) Dimensions(mm) Abmessungen (mm)	Kod Code	Tipi Type	Parça Part	Ölçüler (mm) Dimensions(mm) Abmessungen (mm)
			M				M
BK017	DNMG 11			BSP010	Baskı Pulu		
BK017-1	TNMG 16			BSP030	Baskı Pulu (Normal)		
BK018	CNMG 16			BSP031	Baskı Pulu		
BK019	WNMG 06			BSP032	Baskı Pulu		
BK020	DNMG 15 CNMG 12 SNMG 12			BY040	M6		
BK021	VNMG 16			BY041	M5		
BK022	TNMG 16			BY042	M6		
BK023	TNMG 22			BY043	M5		
BK024	DNMG 11 (Small)			BY044			
BK025	CNMG 19			BSP020	TNMG 16 WNMG 06		
BK027	SNMG 25			BSP021	TNMG 22 DNMG 11 WNMG 08		
BK026	WNMG 08			TL3	L12,2-D3,5		
BK028	KNUX Sağ/ Right			TL3B	L10-D3		
BK030	KNUX/Left			TL4	L13-D4,5		
BK035	RDMT 16			TL4A	L10,5-D4,7		
BK036	TPKN16			TL4B	L15,6-D5		
BK300	OFCR 07			TS-3	D6,65-L5,5		
				TS-4	D7,71-L7		



Kod Code	Tipi Type	Parça Part	Ölçüler (mm) Dimensions(mm) Abmessungen (mm)	Kod Code	Tipi Type	Parça Part	Ölçüler (mm) Dimensions(mm) Abmessungen (mm)
			M				M
TA014	DNMG 15 Shim			TA050	SNMG 12 Shim		
TA014-1	DNMG 15 Shim			TA051	SNMG 19 Shim		
TA013	DNMG 11 Shim			TA053	SNMG 25 Shim		
TA023	CNMG 09 Shim			TA046	KNUX RIGHT Shim		
TA016	CNMG 12 Shim			TA048	KNUX LEFT Shim		
TA016-1	CNMG 12 Shim			TA030	DCMT 11 Shim		
TA022	CNMG 16 Shim			TA034	VBMT 16 Shim		
TA017	CNMG 19 Shim			TA032	VCMT 16 Shim		
TA021	WNMG 06 Shim			TA033	VNMG 16 SHİM		
TA020-1	WNMG 08 Shim			TA010	TPKN 16 Shim		
TA020	WNMG 08 Shim			TA012	TPKN 22 Shim		
TA019	TNMG 16 Shim			TA015	CCMT 09 Shim		
TA045	TNMG 22 Shim			TA015-1	CCMT 12 Shim		
TA052	SEET 12 Shim			TA040	ER 16 Shim		
				TA061	16 ER Shim		
				TA060	16 IR Shim		
				TA062	22 ER Shim		
				TA063	22 IR Shim		
				TA064	27 ER Shim		
				TA065	27 IR Shim		

● Stokta/ In Stock/ Lager ○ Sınırlı Stok/ Limited Stock/ Begrenzte Lagerhaltung

Kalite için Teknik Çözüm | Technical Solution For Quality

BROTECH

TEKNİK
Cutting Tools

www.teknikcuttingtools.com

265

ÇAPLAR VE Vc HIZINA GÖRE KULLANILAN DEVİRLER n(dev./dk)
Diameter and Vc delivery / Durchmesser und die Vc Zustellung

ÇAPLAR
Bore diameter / Durchmesser

VC HIZI m/dk	10	12	16	22	25	30	33	38	42	48	52	55	60	65	70	75	80	90	100	110	120	130
50	1592	1326	995	723	637	531	482	419	379	332	306	289	265	245	227	212	199	177	159	145	133	122
60	1910	1592	1194	868	764	637	579	503	455	398	367	347	318	294	273	255	239	212	191	174	159	147
70	2228	1857	1393	1013	891	743	675	586	531	464	428	405	371	343	318	297	279	248	223	203	186	171
80	2546	2122	1592	1157	1019	849	772	670	606	531	490	463	424	392	364	340	318	283	255	231	212	196
90	2865	2387	1790	1302	1146	955	868	754	682	597	551	521	477	441	409	382	358	318	286	260	239	220
100	3183	2653	1989	1447	1273	1061	965	838	758	663	612	579	531	490	455	424	398	354	318	289	265	245
110	3501	2918	2188	1592	1401	1167	1061	921	834	729	673	637	584	539	500	467	438	389	350	318	292	269
120	3820	3183	2387	1736	1528	1273	1157	1005	909	796	735	694	637	588	546	509	477	424	382	347	318	294
130	4138	3448	2586	1881	1655	1379	1254	1089	985	862	796	752	690	637	591	552	517	460	414	376	345	318
140	4456	3714	2785	2026	1783	1485	1350	1173	1061	928	857	810	743	686	637	594	557	495	446	405	371	343
150	4775	3979	2984	2170	1910	1592	1447	1256	1137	995	918	868	796	735	682	637	597	531	477	434	398	367
160	5093	4244	3183	2315	2037	1698	1543	1340	1213	1061	979	926	849	784	728	679	637	566	509	463	424	392
170	5411	4509	3382	2460	2165	1804	1640	1424	1288	1127	1041	984	902	833	773	722	676	601	541	492	451	416
180	5730	4775	3581	2604	2292	1910	1736	1508	1364	1194	1102	1042	955	881	819	764	716	637	573	521	477	441
190	6048	5040	3780	2749	2419	2016	1833	1592	1440	1260	1163	1100	1008	930	864	806	756	672	605	550	504	465
200	6366	5305	3979	2894	2546	2122	1929	1675	1516	1326	1224	1157	1061	979	909	849	796	707	637	579	531	490
210	6685	5570	4178	3038	2674	2228	2026	1759	1592	1393	1285	1215	1114	1028	955	891	836	743	668	608	557	514
220	7003	5836	4377	3183	2801	2334	2122	1843	1667	1459	1347	1273	1167	1077	1000	934	875	778	700	637	584	539
230	7321	6101	4576	3328	2928	2440	2219	1927	1743	1525	1408	1331	1220	1126	1046	976	915	813	732	666	610	563
240	7639	6366	4775	3472	3056	2546	2315	2010	1819	1592	1469	1389	1273	1175	1091	1019	955	849	764	694	637	588
250	7958	6631	4974	3617	3183	2653	2411	2094	1895	1658	1530	1447	1326	1224	1137	1061	995	884	796	723	663	612



TORNALAMA İÇİN FORMÜLLER

Formulas for turning / Formeln für Drehen

$$\text{DEVİR SAYISI} = n = \frac{V_c \times 1000}{\pi \times D} \text{ devir / dakika}$$

Revolutions / Umdrehungen Revs / min. Umdrehungen / min.

n :Devir Sayısı (dev./dak.)
Revolutions / Umdrehungen Revs / min. Umdrehungen / min.

n :Devir Sayısı (dev./dak.)
Cutting Speed / Schnittgeschwindigkeit (Meter / min.)

$$\text{KESME HIZI} = V_c = \frac{\pi \times D \times n}{1000} \text{ metre / dakika}$$

Cutting speed meter / min. Schnittgeschwindigkeit

D :İş Parçasının Çapı (mm)
Workpiece diameter / Werkstückdurchmesser

π:Sabit Sayı (3,14)
Constant (3,14) / Gleich bleibend (3,14)

TORNALAMADA İŞLEME ZAMANININ HESAPLANMASI

Formulas for turning time / Formeln für Drehen Zeiten

$$\text{Çap Tornalamada} = t_h = \frac{L \times P_s}{n \times f} \text{ dakika}$$

Turning diameter minute Drehdurchmesser

Ps : Paso Sayısı (kaç defa'da)
no of passes / Durchgänge

th : İşleme Zamanı (dakika)
Processing Time / Bearbeitungszeit (min)

f : İlerleme (mm)
Length delivery / Stirn Zustellung (mm)

$$\text{Alın Tornalama} = t_h = \frac{d \times \pi \times L \times P_s}{V_c \times 1000 \times f} \text{ dakika}$$

Length turning / Stirn Drehen minute

Alın Tornalama
İçin Boy $L = \frac{d_1 - d_2}{2} \text{ mm}$

Length head turning / Länge für Stirn Drehen

Dolu Malzemedede
Alın Tornalama $L = \frac{d}{2} \text{ mm}$

Solid Stock front turning / Massive Werkstücke Stirn Drehen

YÜZEY FREZELEMEDE KULLANILAN FORMÜLLER

Cutting Recommendations for Milling / Schnitt - Empfehlungen zum Fräsen

$$\text{DEVİR SAYISI} = n = \frac{V_c \times 1000}{\pi \times D} \text{ devir / dakika}$$

Revolutions / Umdrehungen Revs / min. Umdrehungen / min.

z :Frezenin Ağız Sayısı (adet)
Number of tooth / Anzahl Schneiden

k :Disk Frezenin Etkif Ağız sayısı (adet)
Effective edge of the cutter / Effektive Schneiden des Fräasers

$$\text{KESME HIZI} = V_c = \frac{\pi \times D \times n}{1000} \text{ metre / dakika}$$

Cutting speed meter / min. Schnittgeschwindigkeit

fz :Ağız Başına İlerleme (mm/ağız)
Delivery per cutting mm/Z / Zustellung pro Schneide mm/Z

th :İşleme Zamanı (dak.)
Processing time / Bearbeitungszeit minute

$$\text{TABLA İLERLEMESİ} = Vf = n \times z \times fz \text{ mm / dak}$$

Delivery / Zustellung mm / min.

th :İşleme Zamanı (dak.)
Processing time / Bearbeitungszeit minute

HASSAS DELİK İŞLEME BARALARI İÇİN

Cutting Data for finis Boring tools / Schnittdaten für Fein Ausdrehwerk-zeuge

	Malzeme / Material	HB	Vc	D 9-14	D 14-24	D 22-32	D 28-44	D 36-56	D 50-82	D 80-130
ÇELİKLER Stel / Stahl P	Karbonsuz Low carbon Steel / C-Stahl	80-125	180-300	0.04-0.08	0.05-0.10	0.06-0.11	0.05-0.13	0.05-0.15	0.06-0.15	0.08-0.20
	Düşük Karbonlu Low carbon Steel / C-Stahl	180-280	180-300	0.03-0.08	0.05-0.08	0.06-0.10	0.06-0.13	0.06-0.15	0.08-0.15	0.10-0.20
	Düşük Alaşımli Low alloy Stel / Niderig legiettre Stahl	140-275	180-300	0.02-0.08	0.04-0.08	0.05-0.10	0.08-0.13	0.08-0.15	0.08-0.15	0.10-0.15
	Yüksek Alaşım High alloy Stel / Hoch legiettre Stahl	220-325	170-300	0.02-0.08	0.03-0.08	0.05-0.10	0.06-0.13	0.06-0.5	0.06-0.15	0.10-0.15
	Paslanmaz Austenite / Niro autenitisch (rostfrei)	135-275	150-300	0.03-0.04	0.04-0.07	0.04-0.07	0.05-0.10	0.05-0.13	0.05-0.15	0.10-0.15
	Döküm Grey cast iron / Grauguss	150-260	200-350	0.03-0.08	0.04-0.06	0.04-0.10	0.08-0.12	0.08-0.15	0.10-0.15	0.10-0.15
	Alüminyum Aluminium	30-150	200-350	0.03-0.10	0.05-0.10	0.05-0.13	0.07-0.15	0.07-0.15	0.10-0.15	0.10-0.15

KABA DELİK İŞLEME BARALARI İÇİN

Cutting Data for Boring tools for rough machining / Schnittdaten für Universal Ausbohröpfe

	Malzeme / Material	HB	Vc	D 9-14	D 14-24	D 22-32	D 28-44	D 36-56	D 50-82	D 80-130
ÇELİKLER Stel / Stahl P	Karbonsuz Low carbon Steel / C-Stahl	80-125	120-180	0.05-0.10	0.05-0.12	0.10-0.15	0.10-0.20	0.10-0.22	0.10-0.25	0.10-0.25
	Düşük Karbonlu Low carbon Steel / C-Stahl	180-280	120-160	0.05-0.10	0.05-0.12	0.10-0.15	0.10-0.20	0.10-0.22	0.10-0.25	0.10-0.25
	Düşük Alaşımli Low alloy Stel / Niderig legiettre Stahl	140-275	120-160	0.05-0.10	0.05-0.10	0.10-0.15	0.10-0.20	0.10-0.22	0.10-0.25	0.10-0.25
	Yüksek Alaşım High alloy Stel / Hoch legiettre Stahl	220-325	130-160	0.05-0.10	0.05-0.10	0.10-0.20	0.10-0.20	0.10-0.20	0.10-0.25	0.10-0.25
	Paslanmaz Austenite / Niro autenitisch (rostfrei)	135-275	110-150	0.05-0.10	0.07-0.10	0.08-0.12	0.10-0.20	0.10-0.20	0.10-0.25	0.10-0.25
	Döküm Grey cast iron / Grauguss	150-260	90-180	0.08-0.10	0.084-0.10	0.10-0.20	0.10-0.20	0.10-0.25	0.10-0.25	0.10-0.25
	Alüminyum Aluminium	30-150	150-220	0.08-0.12	0.10-0.15	0.10-0.15	0.10-0.20	0.10-0.25	0.10-0.25	0.10-0.25

3D U-DRILL' LER İÇİN

Cutting Data for 3XD Inset Drills / Schnittdaten für 3xD Vollbohrer

	Malzeme / Material	HB	Vc	D 13-15	D 16-24	D 25-32	D 33-40	D 41-56	
ÇELİKLER Stel / Stahl P	Karbonsuz Low carbon Steel / C-Stahl	<0.15%C 0.15-0.45%C	80-170	120-220	0.04-0.08	0.05-0.10	0.05-0.10	0.04-0.10	0.08-0.12
	Düşük Karbonlu Low carbon Steel / C-Stahl	>=0.45%C	180-280	80-180	0.04-0.08	0.04-0.10	0.05-0.12	0.08-0.15	0.10-0.20
	Düşük Alaşımli Low alloy Stel / Niderig legiettre Stahl		140-275	70-150	0.04-0.10	0.06-0.13	0.01-0.18	0.11-0.20	0.13-0.25
	Yüksek Alaşım High alloy Stel / Hoch legiettre Stahl		220-325	30-150	0.04-0.08	0.04-0.10	0.06-0.12	0.08-0.14	0.10-0.18
	Paslanmaz Austenite / Niro autenitisch (rostfrei)		135-275	50-130	0.04-0.08	0.04-0.10	0.06-0.12	0.08-0.14	0.10-0.18
			135-275	60-150	0.04-0.08	0.04-0.12	0.06-0.14	0.08-0.18	0.12-0.20
	Döküm Grey cast iron / Grauguss		150-220	130-220	0.04-0.12	0.06-0.14	0.08-0.18	0.10-0.20	0.12-0.25
	Alüminyum Aluminium		30-150	150-280	0.04-0.12	0.06-0.14	0.08-0.16	0.10-0.20	0.12-0.25



ISO	Malzeme / Material	HB	Malzeme No.	DIN	TS	ABD AISI/SAE	
P ÇELİKLER Steel / Stahl	Alaşimsız Çelikler Low carbon Steel C-Stahl %C0,05-0,25	80 - 170	1.0116	St 37-3	St 37-3	A 573-81 65	
			1.0401	C15	C15	1015	
			1.0402	C22	C22	1020	
			1.0715	9SMn28	9SMn28	1213	
			1.0718	9SMnPb28	9SMnPb28	12L13	
			1.0722	10SPb20	10SPb20	-	
			1.0736	9SMn36	9SMn36	1215	
			1.0737	9SMnPb36	9SMnPb36	12L14	
			1.1141	Ck15	Ck15	1015	
	1.1158	Ck25	Ck25	1025			
	%C0,25-0,55	125-225	1.0501	C35	C35	1035	
			1.0503	C45	C45	1045	
1.0726			35S20	35S20	1140		
1.1157			40Mn4	40Mn4	1039		
1.1167			36Mn5	36Mn5	1335		
1.1170			28Mn6	28Mn6	1330		
1.1191	Ck 45	Ck 45	1045				
%C0,55-0,80	150-225	1.0535	C 55	C 55	1055		
		1.1203	Ck 55	Ck 55	1055		
		1.1221	Ck 60	Ck 60	1060		
Düşük Alaşımli Çelikler Low alloy Steel Niderig legiettre Stahl	140 - 275	1.0841	St52-3	St52-3	5120		
		1.0961	60SiCr7	60SiCr7	9262		
		1.3505	100Cr6	100Cr6	52100		
		1.6523	21NiCrMo2	21NiCrMo2	8620		
		1.6546	40NiCrMo22	40NiCrMo22	8740		
		1.7131	16MnCr5	16MnCr5	5115		
		1.6582	35CrNiMo6	35CrNiMo6	4340		
		1.7035	41Cr4	41Cr4	5140		
		1.7218	25CrMo4	25CrMo4	4130		
		1.7225	42CrMo4	42CrMo4	4140		
		1.8159	50CrV4	50CrV4	6150		
		Yüksek Alaşımli Çelikler High alloy Steel Hoch legiettre Stahl	220 - 325	1.2080	X210Cr12	X210Cr12	D3
				1.2344	X40CrMoV51	X40CrMoV51	H13
				1.3343	S6-5-2	S6-5-2	D3
				1.2379	X210Cr12G	X210Cr12G	HNV3
Öztenitik Malzemeler Austenite	135 - 175	1.4350	X5CrNi189	X5CrNi189	304		
		1.4401	X5CrNiMo18-10	X5CrNiMo18-10	316		
		1.4845	X12CrNi25-21	X12CrNi25-21	310S		
Feritik/Martensitik Malzemeler	135 - 275	1.4000	X7Cr13	X7Cr13	403		
		1.4005	X12CrS13	X12CrS13	416		
		1.4006	X10Cr13	X10Cr13	410		
K DÖKÜM Cast Iron / Gusseisen	Gri Dökme Demirler Grey cast iron Grauguss	150 - 220	0.6015	GG15	GG15	No25B	
			0.6020	GG20	GG20	No30B	
			0.6025	GG25	GG25	No35B	
			0.6030	GG30	GG30	No45B	
			0.6035	GG35	GG35	No50B	
	Temper Döküm Malleable cast iron Temperguss	150 - 250	0.8145	GTS45	GTS45	40010	
0.8155	GTS50	GTS50	50005				
Sfero Dökme Demirler Spheroidal cast iron Sphäroguss	180 - 260	0.7040	GGG40	GGG40	60-40-18		
		0.7050	GGG50	GGG50	80-85-06		
		0.7070	GGG70	GGG70	100-70-03		
ALÜMİNYUM Aluminium	Alüminyum Alaşımli Aluminium alloy Aluminium Legierungen	30 - 150	3.0255	AL99,5	AL99,5	1000	
			3.2315	ALMgSi1	ALMgSi1	-	
	Özel Alaşımli Special Alloys Sonder Legierungen	30 - 150	3.1325	ALMg1	ALMg1	2024	
3.3245	ALMg3Si	ALMg3Si	-				

1	2	3	4																																																				
Kesici Uç Tipi Cutting Style Plattenform	Uç Açısı Clearance Angle Fräswinkel	Uç Toleransları Tolerance Toleranz	Kesici Uç Delik Tipi Type of Insert Plattentyp																																																				
		<table border="1"> <thead> <tr> <th>Sembol</th> <th>m (+)</th> <th>s (+)</th> <th>d (+)</th> </tr> </thead> <tbody> <tr> <td>A</td> <td>0,005</td> <td>0,025</td> <td>0,025</td> </tr> <tr> <td>F</td> <td>0,005</td> <td>0,025</td> <td>0,013</td> </tr> <tr> <td>C</td> <td>0,013</td> <td>0,025</td> <td>0,025</td> </tr> <tr> <td>H</td> <td>0,013</td> <td>0,025</td> <td>0,013</td> </tr> <tr> <td>E</td> <td>0,025</td> <td>0,025</td> <td>0,025</td> </tr> <tr> <td>G</td> <td>0,025</td> <td>0,130</td> <td>0,05-0,013</td> </tr> <tr> <td>J</td> <td>0,005</td> <td>0,025</td> <td>0,05-0,013</td> </tr> <tr> <td>K</td> <td>0,013</td> <td>0,025</td> <td>0,05-0,013</td> </tr> <tr> <td>L</td> <td>0,025</td> <td>0,025</td> <td>0,05-0,013</td> </tr> <tr> <td>M</td> <td>0,08-0,18</td> <td>0,130</td> <td>0,05-0,013</td> </tr> <tr> <td>N</td> <td>0,08-0,18</td> <td>0,025</td> <td>0,05-0,013</td> </tr> <tr> <td>U</td> <td>0,05-0,38</td> <td>0,130</td> <td>0,08-0,025</td> </tr> </tbody> </table>	Sembol	m (+)	s (+)	d (+)	A	0,005	0,025	0,025	F	0,005	0,025	0,013	C	0,013	0,025	0,025	H	0,013	0,025	0,013	E	0,025	0,025	0,025	G	0,025	0,130	0,05-0,013	J	0,005	0,025	0,05-0,013	K	0,013	0,025	0,05-0,013	L	0,025	0,025	0,05-0,013	M	0,08-0,18	0,130	0,05-0,013	N	0,08-0,18	0,025	0,05-0,013	U	0,05-0,38	0,130	0,08-0,025	
		Sembol	m (+)	s (+)	d (+)																																																		
		A	0,005	0,025	0,025																																																		
		F	0,005	0,025	0,013																																																		
		C	0,013	0,025	0,025																																																		
		H	0,013	0,025	0,013																																																		
		E	0,025	0,025	0,025																																																		
		G	0,025	0,130	0,05-0,013																																																		
		J	0,005	0,025	0,05-0,013																																																		
		K	0,013	0,025	0,05-0,013																																																		
L	0,025	0,025	0,05-0,013																																																				
M	0,08-0,18	0,130	0,05-0,013																																																				
N	0,08-0,18	0,025	0,05-0,013																																																				
U	0,05-0,38	0,130	0,08-0,025																																																				

T P K N 22 04 08 F R

5	6	7	8																																																													
Kesme Kenar Uzunluğu Length of Cutting Edge Schneiden länge	Uç Kalınlığı Height of Cutting Edge Schneidkantenhöhe	Uç Radüsü Insert Radius Planfasse oder Eckenradius	Kesme Kenarı Şekli Insert Shapes WSP-FORM																																																													
			<table border="1"> <tbody> <tr> <td>F</td> <td>Keskin</td> <td>E</td> <td>Yuvarlatılmış</td> </tr> <tr> <td>T</td> <td>Açılı</td> <td>S</td> <td>Açılı</td> </tr> </tbody> </table>	F	Keskin	E	Yuvarlatılmış	T	Açılı	S	Açılı																																																					
			F	Keskin	E	Yuvarlatılmış																																																										
			T	Açılı	S	Açılı																																																										
			<table border="1"> <thead> <tr> <th>Sembol</th> <th>S</th> <th>Sembol</th> <th>m (+)</th> </tr> </thead> <tbody> <tr> <td>01</td> <td>1,59</td> <td>00</td> <td>0</td> </tr> <tr> <td>T1</td> <td>1,98</td> <td>02</td> <td>0,2</td> </tr> <tr> <td>02</td> <td>2,38</td> <td>04</td> <td>0,4</td> </tr> <tr> <td>T2</td> <td>2,58</td> <td>08</td> <td>0,8</td> </tr> <tr> <td>03</td> <td>3,18</td> <td>12</td> <td>1,2</td> </tr> <tr> <td>T3</td> <td>3,97</td> <td>16</td> <td>1,6</td> </tr> <tr> <td>04</td> <td>4,76</td> <td>24</td> <td>2,4</td> </tr> <tr> <td>05</td> <td>5,56</td> <td>32</td> <td>3,2</td> </tr> <tr> <td>06</td> <td>6,35</td> <td></td> <td></td> </tr> <tr> <td>07</td> <td>7,94</td> <td></td> <td></td> </tr> <tr> <td>09</td> <td>9,52</td> <td></td> <td></td> </tr> </tbody> </table>	Sembol	S	Sembol	m (+)	01	1,59	00	0	T1	1,98	02	0,2	02	2,38	04	0,4	T2	2,58	08	0,8	03	3,18	12	1,2	T3	3,97	16	1,6	04	4,76	24	2,4	05	5,56	32	3,2	06	6,35			07	7,94			09	9,52			<table border="1"> <thead> <tr> <th colspan="2">9</th> </tr> <tr> <th colspan="2">İlerleme Yönü Bearbeitung Spichtung Hand of Tool</th> </tr> </thead> <tbody> <tr> <td>Sol Yön</td> <td>Sag Yön</td> </tr> <tr> <td></td> <td></td> </tr> <tr> <td>Nötr</td> <td></td> </tr> <tr> <td></td> <td></td> </tr> </tbody> </table>	9		İlerleme Yönü Bearbeitung Spichtung Hand of Tool		Sol Yön	Sag Yön			Nötr			
			Sembol	S	Sembol	m (+)																																																										
			01	1,59	00	0																																																										
			T1	1,98	02	0,2																																																										
			02	2,38	04	0,4																																																										
			T2	2,58	08	0,8																																																										
			03	3,18	12	1,2																																																										
T3	3,97	16	1,6																																																													
04	4,76	24	2,4																																																													
05	5,56	32	3,2																																																													
06	6,35																																																															
07	7,94																																																															
09	9,52																																																															
9																																																																
İlerleme Yönü Bearbeitung Spichtung Hand of Tool																																																																
Sol Yön	Sag Yön																																																															
Nötr																																																																









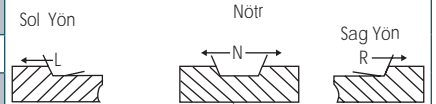

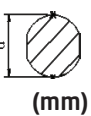



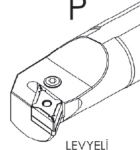
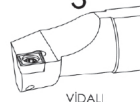
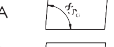

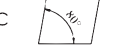
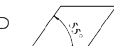
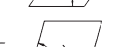

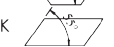

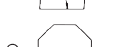

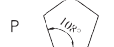

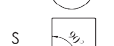

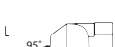



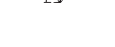



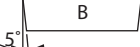
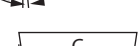
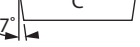

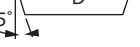
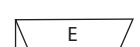

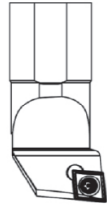
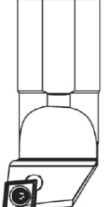







1	2	3			4	
Kesici Uç Tipi Cutting Style Plattenform	Uç Açısı Insert Angle Fräswinkel	Uç Toleransları Tolerance Toleranz			Kesici Uç Delik Tipi Type of Insert Plattentyp	
		Sembol	m (+)	s (+)	d (+)	
		A	0,005	0,025	0,025	
		F	0,005	0,025	0,013	
		C	0,013	0,025	0,025	
		H	0,013	0,025	0,013	
		E	0,025	0,025	0,025	
		G	0,025	0,130	0,05-0,013	
		J	0,005	0,025	0,05-0,013	
		K	0,013	0,025	0,05-0,013	
		L	0,025	0,025	0,05-0,013	
M	0,08-0,18	0,130	0,05-0,013			
N	0,08-0,18	0,025	0,05-0,013			
U	0,05-0,38	0,130	0,08-0,025			











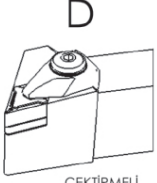

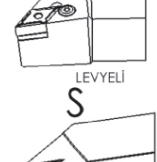
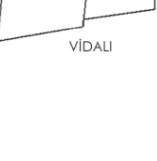
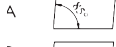

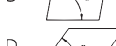

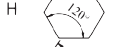
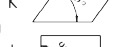





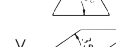
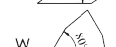











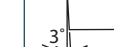



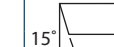

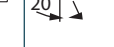

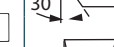
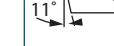

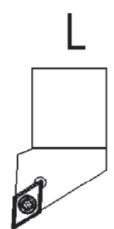
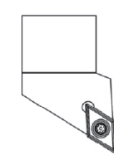





D N M G 15 06 08 HR

5	6	7	8				
Kesme Kenar Uzunluğu Length of Cutting Edge Schneiden länge	Uç Kalınlığı Height of Cutting Edge Schneidkantenhöhe	Uç Radüsü Insert Radius Planfase oder Eckenradius	Kesme Kenarı Şekli Insert Shapes WSP-FORM				
			Keskin Açılı Yuvarlatılmış Açılı				
			Sembol	S	Sembol	m (+)	9 Uç Formları Insert Shapes WSP-Forml
			01	1,59	00	0	
			T1	1,98	02	0,2	
			02	2,38	04	0,4	
			T2	2,58	08	0,8	
			03	3,18	12	1,2	
			T3	3,97	16	1,6	
			04	4,76	24	2,4	
			05	5,56	32	3,2	
06	6,35						
07	7,94						
09	9,52						



1	2	3	4	5	6	7	8	9																								
Takım Malzemesi Type of Shank Schaftansführung	Şaft Geniřlięi Shank Schaft	Takım Boyu Tool Length Werkzeuglänge	Uç Baęlama Sistemi Clamping System Klemmsystem	Kesici Uç Tipi Insert From WSP-Form	Kater Tipi Tool Type Shank Werkzeugtyp	Uç Aęısı Insert Angle WSP-Freiwinkel	Kenar Yönu Holder Execution Bearbestungsrichtung	Uç Kenar Uzunluęu Cutting Edge WSP-Grösse																								
A: Çelik Gövdeli İçten Soęutmalı Coolan Through Steel Shank Mit Kühlbohrung	 (mm) (mm)	 (mm)	D  CEKTİRMELİ M  BASKI PABUÇLU P  LEVYELİ S  VIDALI	A  B  C  D  E  H  K  L  M  O  P  R  S  T  V  W 	F  L  Q  S  U  W  Z  X  X = ÖZEL Special Sonderform	A  B  C  D  E  F  G  P  N  Özel Special O 	R  L 	A  B  C  D  E  K  L  M  O  P  R  S  T  V  W 																								
									C: Toz Metal Gövdeli Hardmetal Shank Hartmetall Stahlkopf	06 = 6 08 = 8 10 = 10 12 = 12 14 = 14 16 = 16 20 = 20 22 = 22 25 = 25 32 = 32 40 = 40 50 = 50	D = 60 E = 70 F = 80 G = 90 H = 100 J = 110 K = 125 L = 140 M = 150 N = 160 P = 170 Q = 180	R = 200 S = 250 T = 300 U = 350 V = 400 W = 450 Y = 500 X = ÖZEL Special Sonderform	X = ÖZEL Special Sonderform	Özel Special O	R L																	
																	E: Toz Metal Gövdeli İçten Soęutmalı Hardmetal Shank With Coolant Hole Hartmetall Schaft mit Kühlbohrung															
																									S: Çelik Gövdeli Steel Shank Stahl Schaft							



1	2	3	4	5	6	7	8	9
Uç Bağlama Sistemi Clamping System Klemmsystem	Kesici Uç Tipi Cutting Style Plattenform	Kater Tipi Type Werkzeugtyp	Uç Açısı Insert Angle WSP-Freiwinkel	Kater Yönü Holder Execution Bearbeitungsrichtung	Şaft Yüksekliği Height of Shank Schaftquerschnitts	Şaft Genişliği Width of Shank Schafbreite	Takım Boyu Length of Holder Werkzeuglänge	Uç Kenar Uzunluğu Length of Cutting Edge WSP-Grösse
<p>D</p>  <p>M</p>  <p>P</p>  <p>S</p>  <p>CEKTİRMELİ BASKI PABUÇLU LEVYELİ VİDALI</p>	<p>A</p>  <p>B</p>  <p>C</p>  <p>D</p>  <p>E</p>  <p>H</p>  <p>K</p>  <p>L</p>  <p>M</p>  <p>O</p>  <p>P</p>  <p>R</p>  <p>S</p>  <p>T</p>  <p>V</p>  <p>W</p> 	<p>A</p>  <p>B</p>  <p>C</p>  <p>D</p>  <p>E</p>  <p>F</p>  <p>G</p>  <p>J</p>  <p>K</p>  <p>L</p>  <p>N</p>  <p>Özel Special O</p>	<p>A</p>  <p>B</p>  <p>C</p>  <p>D</p>  <p>E</p>  <p>F</p>  <p>G</p>  <p>H</p>  <p>J</p>  <p>K</p>  <p>L</p>  <p>N</p>  <p>Özel Special O</p>	<p>L</p>  <p>R</p>  <p>N</p> 	<p>(mm)</p> <p>06 = 6</p> <p>08 = 8</p> <p>10 = 10</p> <p>12 = 12</p> <p>14 = 14</p> <p>16 = 16</p> <p>20 = 20</p> <p>22 = 22</p> <p>25 = 25</p> <p>32 = 32</p> <p>40 = 40</p> <p>50 = 50</p>	<p>(mm)</p> <p>06 = 6</p> <p>08 = 8</p> <p>10 = 10</p> <p>12 = 12</p> <p>14 = 14</p> <p>16 = 16</p> <p>20 = 20</p> <p>22 = 22</p> <p>25 = 25</p> <p>32 = 32</p> <p>40 = 40</p> <p>50 = 50</p>	<p>(mm)</p> <p>D = 60</p> <p>E = 70</p> <p>F = 80</p> <p>G = 90</p> <p>H = 100</p> <p>J = 110</p> <p>K = 125</p> <p>L = 140</p> <p>M = 150</p> <p>N = 160</p> <p>P = 170</p> <p>Q = 180</p> <p>R = 200</p> <p>S = 250</p> <p>T = 300</p> <p>U = 350</p> <p>V = 400</p> <p>W = 450</p> <p>Y = 500</p> <p>X = ÖZEL Special Sonderform</p>	<p>A (mm)</p>  <p>B</p>  <p>C</p>  <p>D</p>  <p>E</p>  <p>K</p>  <p>L</p>  <p>M</p>  <p>O</p>  <p>P</p>  <p>R</p>  <p>S</p>  <p>T</p>  <p>V</p>  <p>W</p> 

● Stokta/In Stock/Lager ○ Sınırlı Stok/Limited Stock/Begrenzte Lagerhaltung

Kalite için Teknik Çözüm | Technical Solution For Quality

BROTECH

TEKNİK
Cutting Tools

www.teknikcuttingtools.com

273

