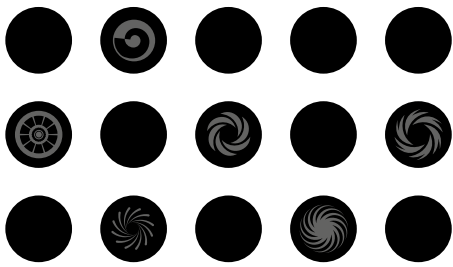


2 0 2 0 - 2 0 2 1
DINOX
NC TOOLING SYSTEM





CONTENTS

Catalog layout guide

- [04](#) Global Networks
- [06](#) DINE Products
- [08](#) DINE History
- [10](#) Application
- [12](#) DINOX Map
- [14](#) Master Index
- [22](#) Catalog Manual
- [23](#) Chuck
- [113](#) Arbor Modular
- [133](#) Boring tool
- [197](#) Angular head
- [218](#) cBN/PCD
- [267](#) Smart factory
- [283](#) TAUMAX
- [295](#) Other
- [312](#) ABC Index



We will be the leading global company
with the best technical skills



DINE Inc. makes a better world with its technologies and quality in addition to customer confidence.

By supplying our customers with high-quality products, we contribute to the development of the automobile, electronics, machinery, and plant industries. Furthermore, we make every effort to demonstrate the excellence of Korean cutting tools to the world by exporting our superior-quality cutting tools overseas.



Achieved ISO quality management system certification

KS Q ISO 9001:2009 / ISO 9001:2008

SBC certifies that the above company's environmental management system meets the requirements of the system standards and certification scope below.



Achieved ISO environmental management system certification

KS I ISO 14001:2009 / ISO 14001:2004

SBC certifies that the above company's management system meets the requirements of the standards and certification scope below.



We have manufactured high-quality T/H products using high-precision equipment and advanced CAM software.

T/H

cBN

We have manufactured cBN and PCD tools essential for machining automobiles, airplanes, and ships, etc.

T/S

We have also manufactured MCT (Machining Center) tools and T/S (Tooling System).



Homepage



Facebook



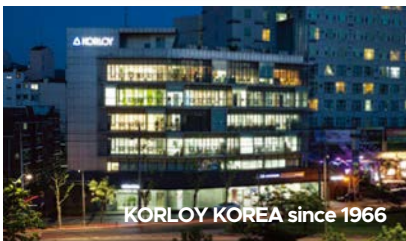
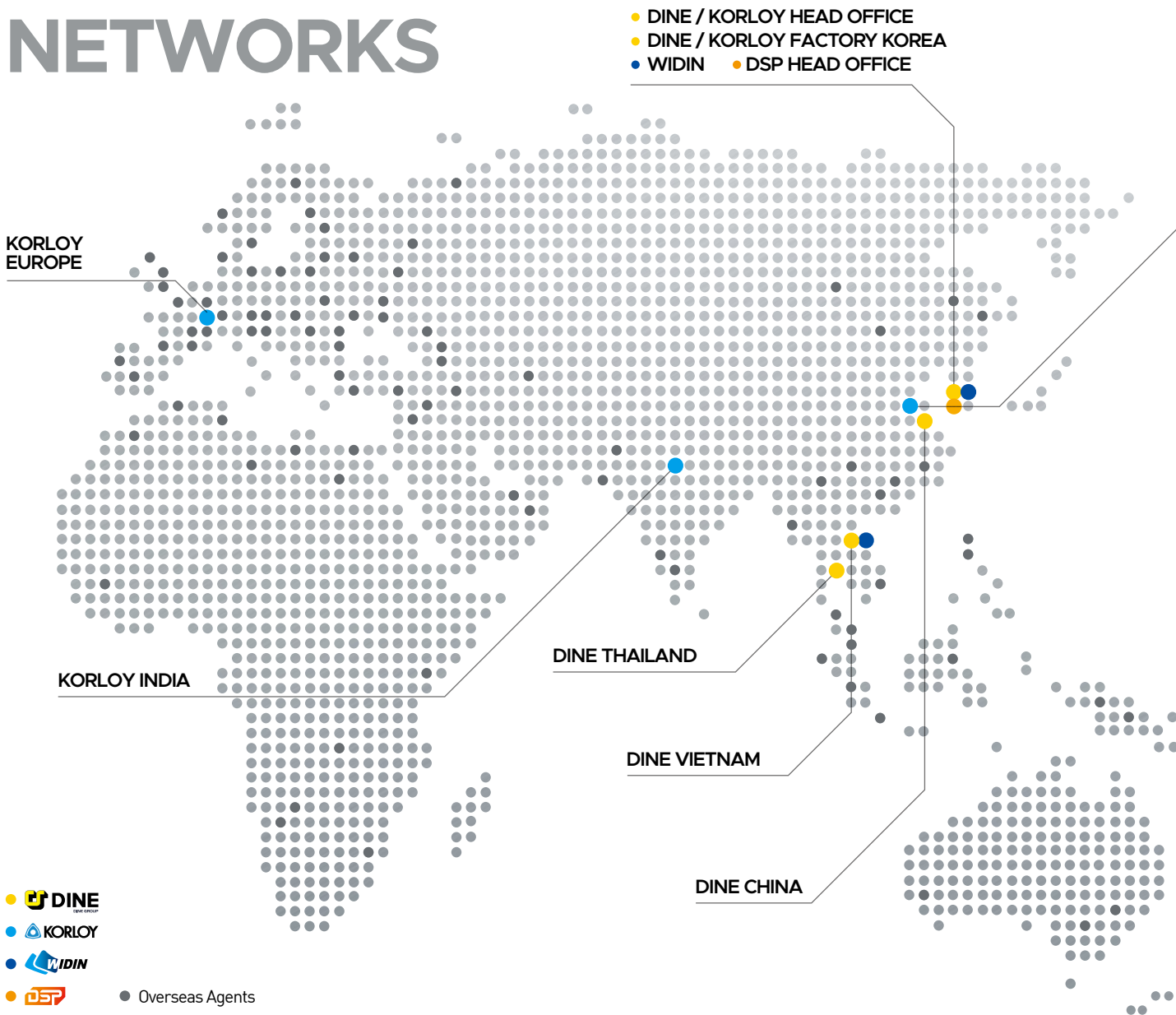
YouTube



KakaoTalk Plus



DINE GROUP GLOBAL NETWORKS



- DINE FACTORY QINGDAO
- KORLOY FACTORY QINGDAO

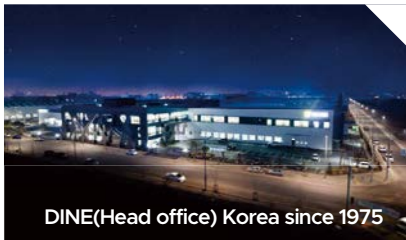
WIDIN AMERICA

KORLOY AMERICA


KOREA NETWORKS

KORLOY BRASIL

- DSP Head Office
- DINE Inc. Head Office (MTV)
- Jungbu Branch
- Daegu Branch
- Nambu Branch
- Nambu Support Center SMART FACTORY
- WIDIN Head Office
- KOROLY Head Office
- Gyeonggin Branch
- KOROLY Jincheon Factory



DINE PRODUCTS

Chuck 

Boring tool 

IT Solution 

Angular head 

Arbor 

PCD 

 BROTECH

TAUMAX 



01	06	DINE PRODUCTS	
02	03		09
	05		
04	07	08	

01 Chuck

Chuck products such as milling chucks, hydraulic expansion chucks, shrinking chucks, collet chucks, and tapping chucks, etc. that available for high-speed and high-precision machining with strong clamping force and perfect balanced boring

02 Boring tool

Structurally stable boring products that boast of wide boring range such as wide diameter boring machining and that enable high-quality mass production using ultrahigh-speed boring

03 IT Solution

High-precision cutting tools for brushes and floating holder products that can machine high-precision data communication equipment such as smart phones and tablet PCs, etc.

04 Arbor

Various types of tool holder products such as cutters, indexable end mills, indexable drills, tool holders, and boring bars

05 Angular head

Angular heads that can create an effect of two machines with one through diverse machining angles and stable operation

06 TAUMAX

Lower-priced entry-level product brands including all kinds of machine parts, machine tools, and peripheral industrial goods released by DINE Inc. to find a new market

07 PCD

Products that show excellent surface roughness and machining accuracy due to their very high hardness and outstanding wear resistance

08 cBN

Optimal products for productivity improvement through excellent processing of cast iron and heat-treated steel due to their strength and resistance

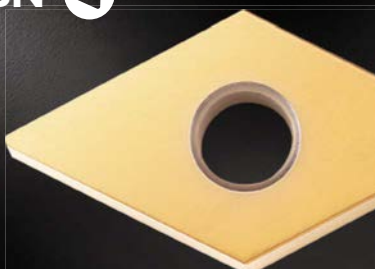
09 Smart factory

Products based on the 4th Industrial Revolution that can enhance productivity, quality, and customer satisfaction, etc. by creating new value and applying information communications technologies to the entire process such as total tool system (MDM Software System) and collaborative robots, etc.



Smart factory 

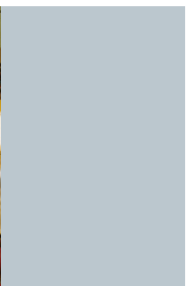
cBN 



DINE HISTORY



- 1975. 07 Founded Hanju Trading Company (sale of imported Cemented carbide alloy cutting tools)
- 1988. 07 Converted into a corporation and renamed DINE, Inc., Im Sang-jin inaugurated
- 1989. 02 Produced holders and locator, started OEM supply to Korloy
- 1990. 04 The manufacturing technology of NC Tooling System was introduced from Kyoritsu Seiki (Japan); Made a contract (for 5 years); Approved by the Commerce-Industry
- 1994. 08 Ministry Signed a contract for introducing the manufacturing technology of cBN cutting tools with Sumitomo in Japan
- 1995. 12 TOOLING SYSTEM factory was transferred (Sihwa Industrial Complex own factory move-in)
- 1997. 03 cBN/PCD factory was transferred (Sihwa Industrial Complex)
- 1997. 09 Started the localization of the integral angular head of Kyoritsu Seiki (Japan)
- 1998. 11 The head office was transferred (1257-4, Jeongwang-dong, Siheung-si, Gyeonggi-do (Sihwa Industrial Complex 2-da 705))
- 1999. 08 Changed company name to DINE after the merger of (Dine, Inc., Dine Co., Ltd., Ilshin Industry, Presto Co., Ltd.)
- 2000. 02 Designated as IBK Family Enterprise (IBK : outstanding enterprise)
- 2001. 07 Achieved ISO 9001 : 2000 certification (SMB Certification Center)
- 2001. 11 Awarded the 3 Million Dollar Export Tower Prize on the 38th Trade Day
- 2003. 03 Applied for a patent on milling chuck with tightening precision improved (application no. 10-2003-0015317) Awarded the 5 Million Dollar Export Tower Prize on the 41st Trade Day
- 2004. 11 Awarded the 5 Million Dollar Export Tower Prize on the 41st Trade Day
- 2006. 01 Opened the second Sihwa factory
- 2006. 04 Selected as a company qualified for SMB learning organization business (HRD Korea)
- 2006. 06 Established DINE China, Inc. (DCI)
- 2006. 10 Established DINE Tool R&D Center; Approved by KOITA
- 2006. 11 Awarded the 10 Million Dollar Export Tower Prize on the 43rd Trade Day
- 2006. 12 Designated as a technology-innovation SMB (INNO-BIZ) by the SMBA
- 2007. 01 Opened the knowledge management system "Dian[다이안]"
- 2007. 04 KIPO No.10-0713805 "Milling chuck with a strong structure preventing foreign substance penetration"
- 2007. 06 Opened a call center
- 2007. 08 Selected as a Gyeonggi-do promising SMB (for 5 years)
- 2007. 10 Established a manufacturing corporation in China
- 2007. 12 Received a presidential citation on the 7th Machinist Day (Chairman Yoon Hye-seop)
- 2008. 07 Broke ground for the manufacturing corporation in China
Achieved zero hazard goal twofold
- 2008. 10 Achieved zero hazard goal threefold
- 2008. 12 Awarded the 20 Million Dollar Export Tower Prize on the 45th Trade Day /
Awarded the 3rd Gyeonggi SMB Prize - export field
- 2009. 12 Signed an MOU with the Qingdao Bonded Area / Held the completion ceremony for the manufacturing corporation in China
- 2010. 02 Applied for a patent on the tool holder mounting system (application no. 10-2010-0012422)
- 2010. 03 Built WEB ERP (enterprise resource planning)
- 2010. 06 System Signed a function promotion agreement (HRD Korea)
- 2010. 07 Awarded the 8th Siheung-si Woman Prize (Chairman Yoon Hye-seop) - economy field



- 2010. 09 Selected as an outstanding enterprise for human resource development (Best HRD)
- 2010. 11 Productivity management system (PMS) was confirmed / Awarded IBK Export Tower - Stone Tower / Designated as a management-innovation SMB (MAIN-BIZ) by the SMBA
- 2011. 03 Awarded "Trader prize of this month who has brought glory to Korea" - Chairman Yoon Hye-seop
- 2011. 05 "National team member agreement for the 41st UK International Vocational Training Competition"
- 2011. 08 KIPO No.10-1060687 Cutting tool module of a machine tool using the dual pitch screw method
- 2011. 09 ISO 14001 certification
- 2011. 11 Zero hazard goal achievement threefold certification (Head office), Zero hazard goal achievement threefold certification (Factory)
- 2011. 12 Awarded the 30 Million Dollar Export Tower Prize on the 48th Trade Day
- 2012. 04 Achieved Excellent Green Biz certification (SMBA) - grade A
- 2012. 05 Selected as an enterprise qualified for Korean-style hidden champion promotion (Export-Import Bank of Korea)
- 2012. 08 Signed a rehabilitation social contribution project agreement (Siheung City Hall)
- 2013. 03 Received a citation from the Minister of Knowledge Economy on the 40th Day of Commerce and Industry : Yoon Hye-seop
Received a citation from the Chairman of Fair Trade Commission on the 12th Day of Fair Trade : Yoon Hye-seop
- 2013. 04 Established FTA SYSTEM
- 2013. 07 Obtained country of origin certification & exporter certification
- 2013. 08 Awarded Siheung City 1% welfare foundation sponsor company citation by Siheung Mayor
- 2013. 12 Acquired DSP Tooling (DSP)
- 2014. 06 Established the standard cost operation system
- 2014. 12 Opened the Incheon Logistics Center (DIW)
- 2015. 07 Head office and factory were integrated and transferred - Siheung Smart Hub MTV Industrial Complex
- 2015. 12 Introduced and established an automatic warehouse system / established small tool production system for the IT industry Newly established Busan branch
- 2016. 01 established Busan branch
- 2016. 04 Held the completion ceremony for the Sihwa Smart Hub MTV new factory
- 2016. 07 Awarded a presidential medal on the 2nd Day of Enterprise of Middle Standing (Chairman Yoon Hye-seop)
- 2016. 11 Awarded the Creation Technology Prize in the autumn symposium by KSMTE (Chairman Yoon Hye-seop)
- 2016. 12 Awarded the 50 Million Dollar Export Tower Prize on the 55th Trade Day (Achieved 100 billion won of annual sales)
- 2017. 01 Launched TAUMAX second brand; started to sell products
- 2017. 02 Opened Vietnam branch (DVC)
- 2017. 03 Started the solar energy generation project
- 2017. 04 Selected as a 2017 small hidden champion (MOEL)
- 2018. 01 Newly established Robot Division
- 2018. 06 Celebrated Company's 30th anniversary
- 2018. 08 Opened Nambu Branch (Ulsan/Changwon/Busan integrated)
- 2018. 10 Acquired WIDIN Co., Ltd.
- 2019. 09 Opened Thailand Branch (DTC)
- 2019. 11 Opened DINE SMART FACTORY Nambu Support Center
- 2020. 01 Changed to the representative director system respectively Im Soo-min inaugurated



TOOL APPLICATION

NC TOTAL TOOLING SYSTEM

GSK

Milling, Drilling, Reaming, Chamfering

OFH

Deburring

DBC

Rough Boring

DHE

Milling, Drilling
Reaming

SAH

Drilling

FBH/B

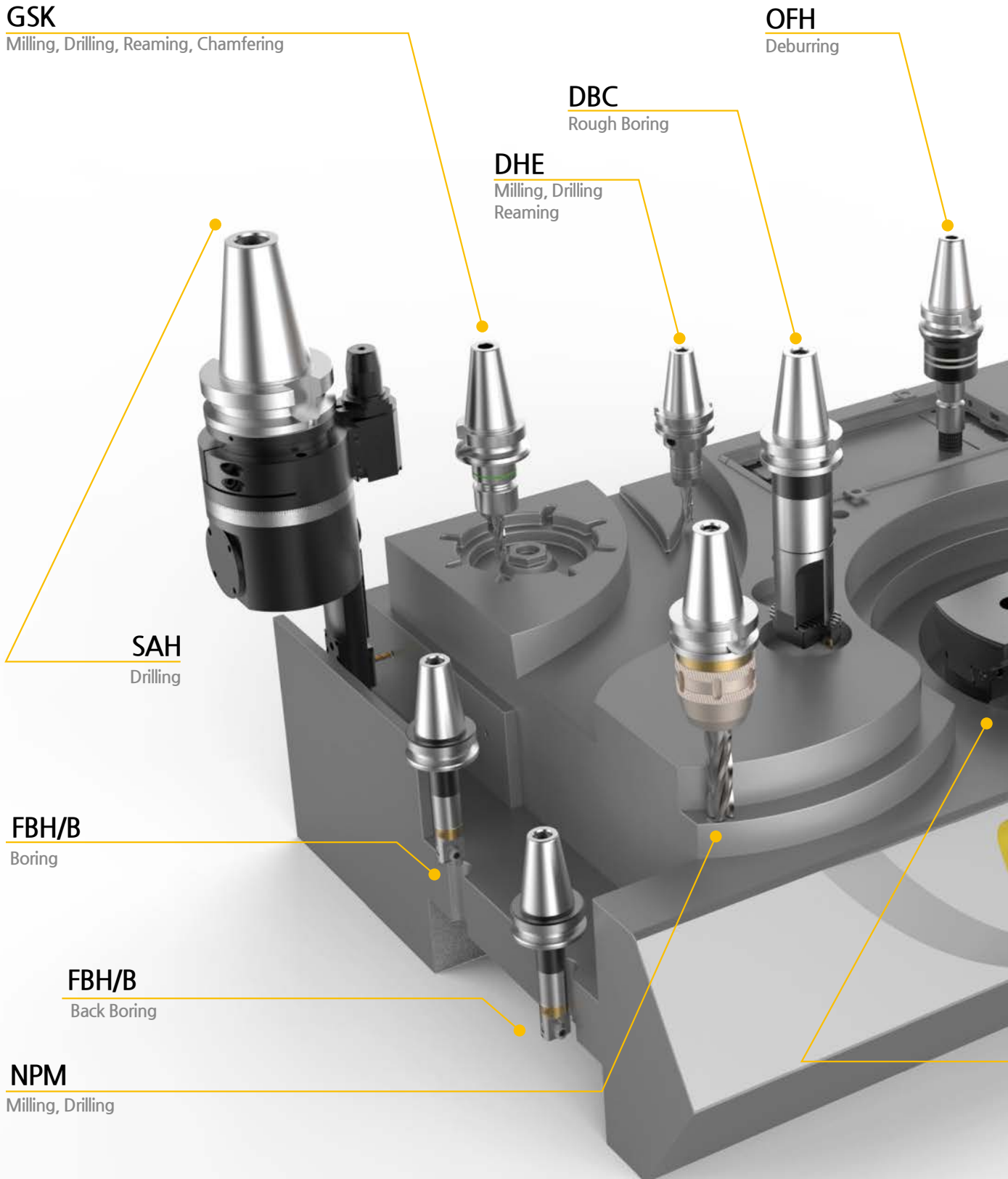
Boring

FBH/B

Back Boring

NPM

Milling, Drilling





DST
Tapping

DSK
Milling, Drilling

SDC/P
Milling, Drilling
Tapping

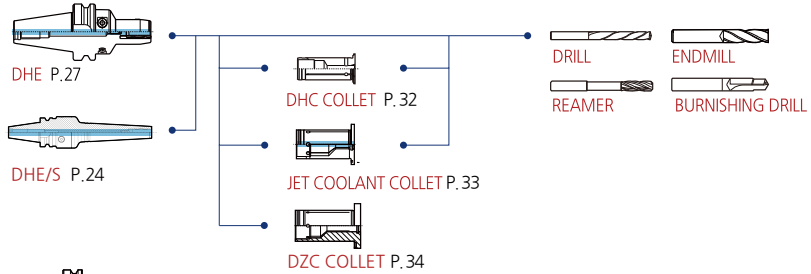
MAH
Milling, Drilling

SLIM DSC
Milling, Drilling, Reaming,
Chamfering

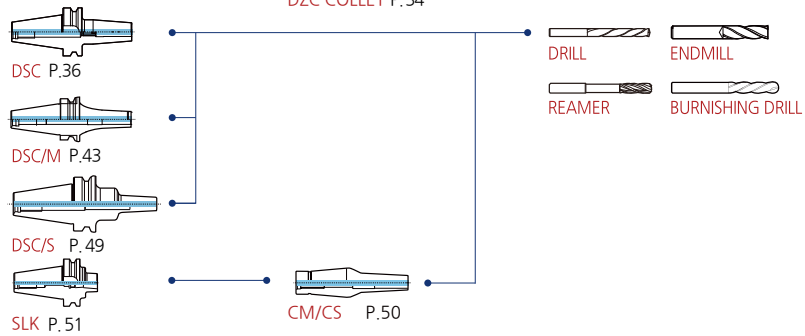
TBC • FBC
Large boring

KMB
Micro boring

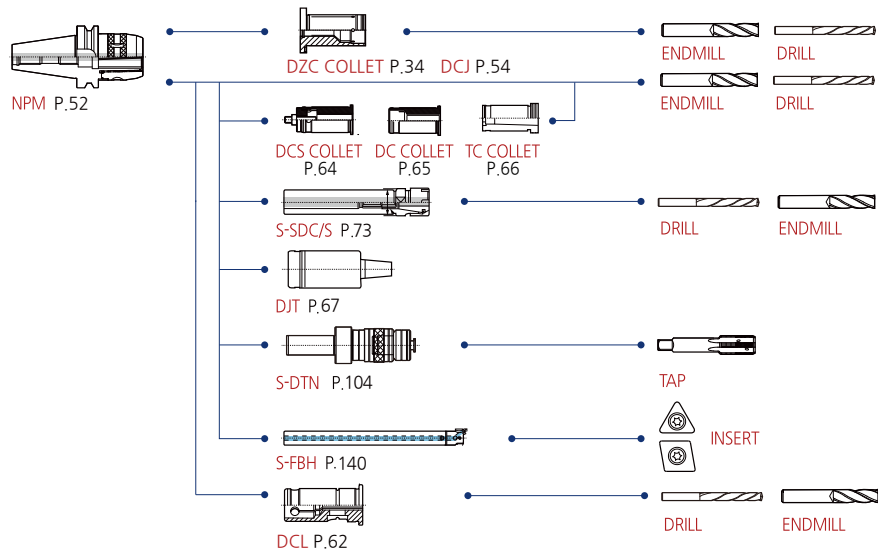
1. Hydraulic expansion chuck



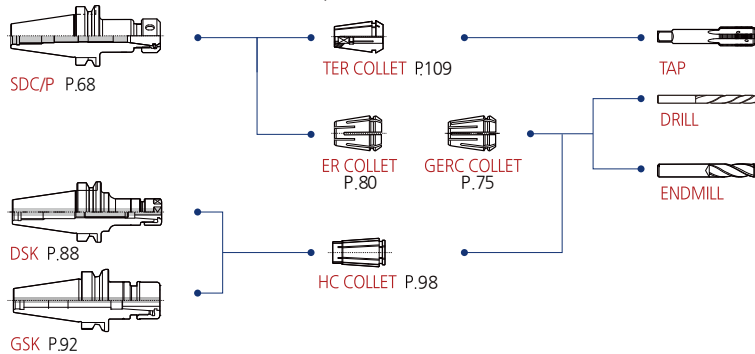
2. Shrinking chuck



3. Milling chuck



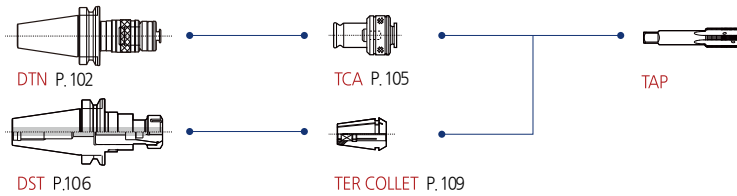
4. Collet chuck



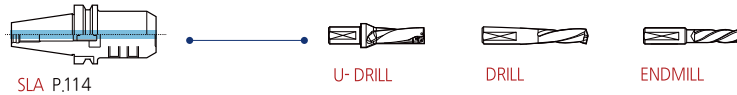
5. Drill chuck



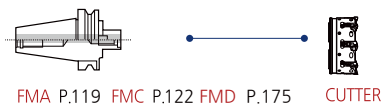
6. Tapping holder



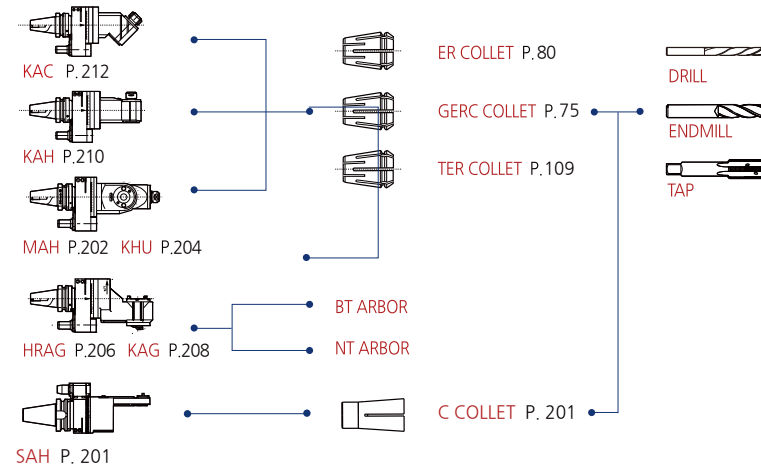
7. Side lock arbor



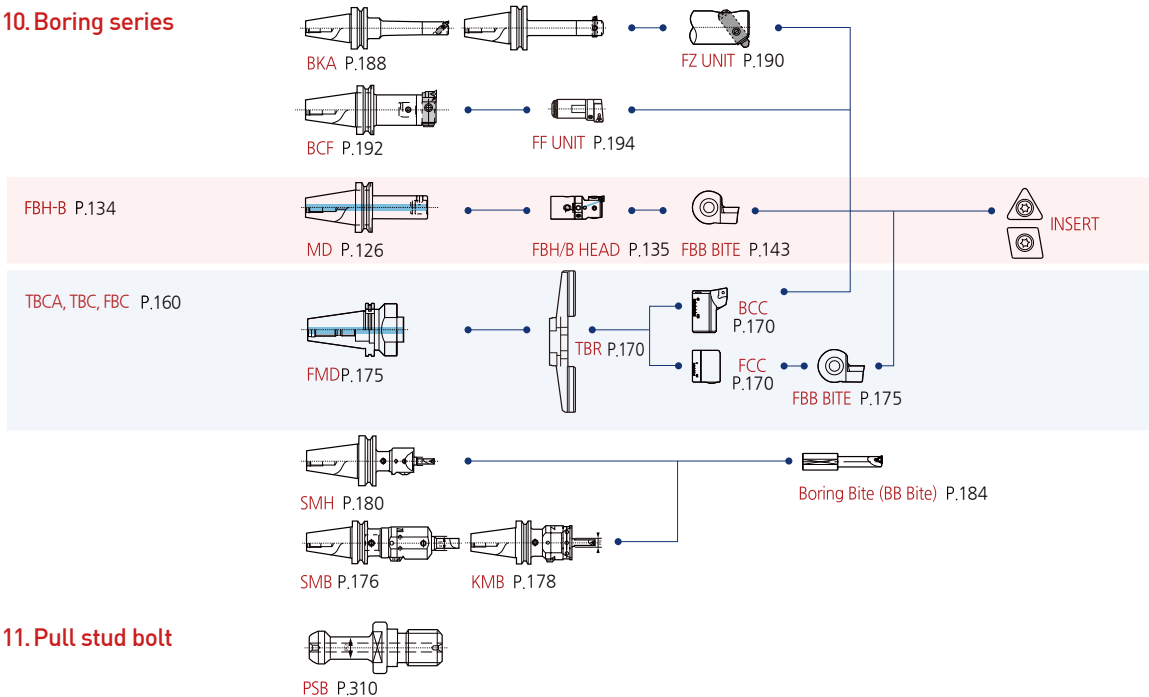
8. Face mill arbor



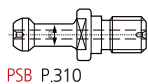
9. Angular head



10. Boring series



11. Pull stud bolt



CHUCK



C

DHE/S NEW

Slim hydraulic expansion chuck

24p



C

DHE

Hydraulic expansion chuck

27p



C

DZC

Zero fit collet

34p



C

DSC

Shrinking chuck

36p



C

NPM

New power milling chuck

52p



C

DCJ

DINE Jetcoolant collet

54p



C

DCL NEW

Lock collet for milling chuck

62p



C

SDC/P

Precision collet chuck for multi purpose machining

68p



C

GERC

GERC collet

75p



C

ER COLLET

ER collet

80p



C

ER/L NEW

Lock collet for ER collet chuck

84p



C

RTJW

Jet coolant disk

86p

- C** Internal coolant system installed.
- C** Internal coolant system **is optional**.
- C** **This product does not support** the internal coolant system.



C

DSK
Slim type collet chuck

88p



C

GSK
Great speed slim type collet chuck

92p



C

HC collet
HC slim collet

98p



C

NPU
Drill chuck

100p



C

DTN
Tapping holder

102p



C

TCA
Tap adapter

105p



C

DST
High speed synchro tapping chuck

106p



C

TER
TER collet
ER tap collet

109p



C

OFH
Floating holder for brush

110p



C

SLA
Side lock arbor

114p



C

MTA
Morse taper arbor

118p



C

FMA
Face mill arbor

119p

ARBOR/MODULAR

Chuck

Arbor / Modular

Boring tool

Angular head

cBN/PCD

Smart factory

TAUMAX

OTHER



C

FMC
Face mill arbor

122p



C

MD
Modular arbor

126p



C

EXT
Extension bar

130p



C

RDC
Reducer bar

130p



C

FBH/B
FBH Back boring & balanced type

134p



C

DBCA NEW
New balance cut tool

144p

BORING TOOL



C

DBC
Balance cut tool (Rough boring)

154p



C

TBCA NEW
Wide diameter boring system

160p



C

TBC
Balance cut tool for Rough boring

166p



C

FBC
Balance cut tool for Fine boring

171p



C

SMB
Small micro boring bar

176p



C

KMB
Micro boring

178p

- C** Internal coolant system installed.
- C** Internal coolant system **is optional**.
- C** **This product does not support** the internal coolant system.

 <p>SMH Small micro boring bar (precision type)</p> <p>180p</p>	 <p>BB BITE BB bite (for SMB, SMH, KMB)</p> <p>184p</p>	 <p>BH Square boring bite for BSA</p> <p>185p</p>
 <p>BSA Square boring bar</p> <p>186p</p>	 <p>BKA FZ micro boring bar</p> <p>188p</p>	 <p>FZ UNIT FZ unit inclined mounting type</p> <p>190p</p>
 <p>BCF Micro boring bar</p> <p>192p</p>	 <p>SAH Slim angular head</p> <p>201p</p>	 <p>MAH MAH for mold(0°-90°) Rigidity-reinforced angular head</p> <p>202p</p>
 <p>KHU KHU Collet type angular head (0°-90°)</p> <p>204p</p>	 <p>HRAG HRAG(90° fixed) Rigidity-reinforced angular head</p> <p>206p</p>	 <p>KAG Attachment type KAG</p> <p>208p</p>

Chuck

Arbor / Modular

Boring tool

Angular head

cBN/PCD

Smart factory

TAUMAX

OTHER

ANGULAR HEAD



C

KAH

Modular type KAH(90° type)
Fixed angle-type angular head

210p

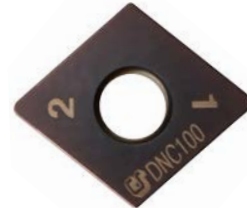


C

KAC

Modular type KAC(45° type)
Fixed angle-type angular head

212p



DNC100

Coating cBN

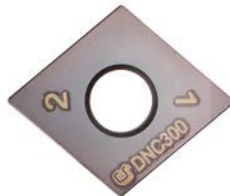
242p



DNC250

Coating cBN

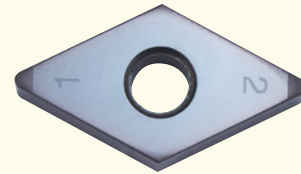
243p



DNC300 NEW

Coating cBN

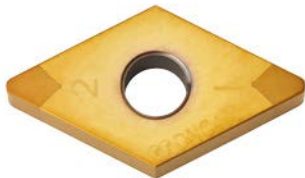
244p



DNC350

Coating cBN

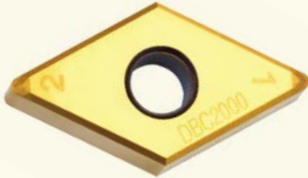
245p



DNC400

Solid type Coating cBN

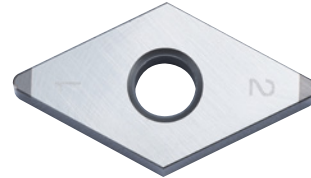
246p



RA, GA Chipbreaker

cBN chipbreaker
Chip breaker

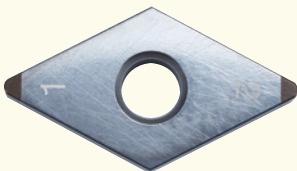
247p



DB1000

Non coating cBN

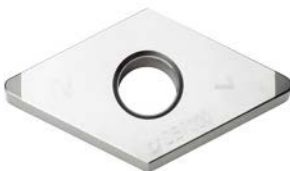
248p



DB2000

Non coating cBN

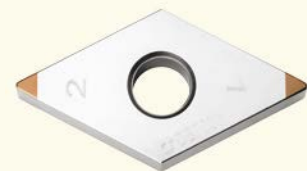
249p



DB7000

Non coating cBN

250p

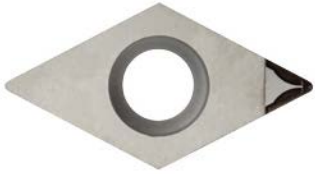
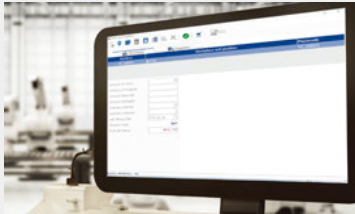












DB7500

Non coating cBN

251p

- C** Internal coolant system installed.
- C** Internal coolant system **is optional**.
- C** **This product does not support** the internal coolant system.

 <p>UC Chipbreaker New PCD insert chipbreaker</p> <p>264p</p>	 <p>MDM MDM software system</p> <p>270p</p>	 <p>M SERIES M series collaborative robot</p> <p>272p</p>	SMART FACTORY	
 <p>A SERIES A series collaborative robot</p> <p>272p</p>	 <p>TOOL MASTER LITE Tool master lite</p> <p>277p</p>	 <p>TOOL MASTER BASIC Tool master basic</p> <p>278p</p>		TAUMAX
 <p>TOOL MASTER QUADRA Tool master quadra</p> <p>279p</p>	 <p>PVT MC POWER VISE PVT Powered Vise</p> <p>284p</p>	 <p>MVT MC MACHINE VISE MVT</p> <p>287p</p>		
 <p>TAPER CLEANER Taper cleaner</p> <p>288p</p>	 <p>MH-200 MH-200 Shrink fit</p> <p>289p</p>	 <p>CLEAN-TEC FAN Clean-tec fan</p> <p>290p</p>		



C

MICRO ADJUSTING CART RIDGE

Precision micro adjusting cartridge

291p



PULLSTUD BOLT WRENCH

Pullstud bolt wrench

291p



TOOL CLAMP NEW

Tool clamp

292p



MAGNETIC NEW BASE

Magnetic base

293p



DIGITAL 3D NEW TASTER

Digital 3d taster

296p



3D TASTER 2007

3D taster 2007

296p

OTHER



HT

Height touch setter

297p



DOP

DINE Optical edge finder
Optical edge finder

297p



DZH

DINE Z axial height gauge

298p



DZP

DINE Z axial setting height gauge

298p



DZOP

DINE Z axial P reset gauge

299p



HDG

Hydraulic expansion chuck gauge

299p

- C** Internal coolant system installed.
- C** Internal coolant system **is optional**.
- C** **This product does not support** the internal coolant system.



ROT
Run-out tester

300p



NTSS
New tool setting stand

301p



Pull stud bolt
Pull stud bolt

310p

Chuck

Arbor / Modular

Boring tool

Angular head

cBN/PCD

Smart factory

TAUMAX

OTHER

Significant pictogram description

Common pictogram

G6.3 G value	Rotational durability value	Ø25 Max Dia	Max. end mill diameter	C Coolant System	Internal coolant system installed.
15,000 Max RPM	Allowable rotation value	130 MIN Range	Min. boring diameter	C Coolant System	Internal coolant system is optional.
5μm Run-out	Vibration tolerance	535 MAX Range	Max. boring diameter	C Coolant System	This product does not support the internal coolant system.

ISO Shank specifications

MAS 403-BT Shank	MAS403 specifications BT shank.
DIN 69893-1 Shank	ISO 12164-1 : 2001 specifications HSK shank.
DIN69871 -1A/B Shank	ISO 7388/1 : 1983(E) specifications SK shank.
DIN2080 JISB6101 Shank	ISO 297 : 1988(E) specifications NT shank.

Insert

0.3mm Max Depth	Coating Coating insert	Non Non-coating insert
K Cast iron	H Heat-treated steel	Sintering parts Sintered parts

Recommended machining grade

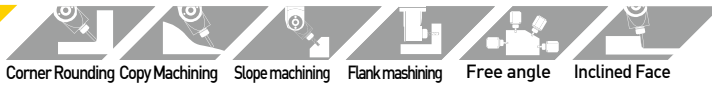
Intermittent cutting intensity

Continuous	Low interrupted	Medium interrupted	Heavy interrupted
-------------------	------------------------	---------------------------	--------------------------

Recommended Machining Works by products



Angular head machining



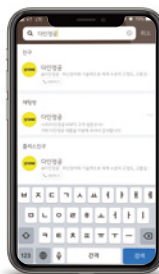
Contact us as KakaoTalk



Run Kakao Talk



Click Find Friends



Search for "Dine Inc."



Start "1:1 Chatting" after adding friends



Make an inquiry



Chuck

DINOX NC TOOLING SYSTEM

CHUCK

DHE/S	24
DHE	27
DHC Collet (general type & waterproof type)	32
DHJ Collet (jet coolant)	33
DZC	34
DSC	36
NPM	52
DCJ	54
DCL	62
SDC/P	68
GERC	75
ER COLLET	80
ER/L	84
RTJW	86
DSK	88
GSK	92
HC COLLET	98
NPU	100
DTN	102
TCA	105
DST PAT.	106
TER	109
OFH	110



DHE/S

Slim hydraulic expansion chuck



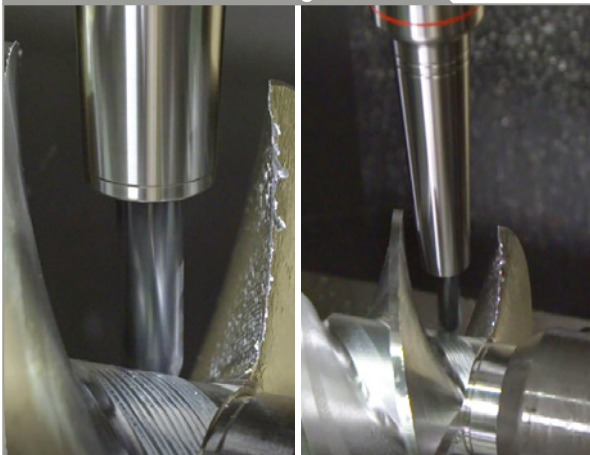
Features

- Optimized chuck for machining that requires high-quality surface roughness and accuracy
- Suitable for challenging mold and automotive parts machining that involves complicated shapes and a lot of interferences
- Ideal for metal impeller machining, which requires deep penetration
- Enables easy tool connection without any additional connecting device
- Easy to perform fine boring operations (0.02-0.2mm)
- Application scope: milling, drilling, reaming

NAMING	BT30	DHE	8	S	115
	Spindle	Hydraulic Expansion Chuck	Tool Dia.	Slim	Length

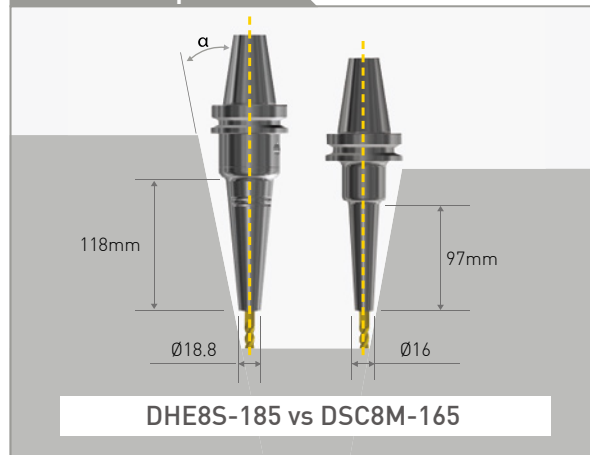


Recommended Machining Works



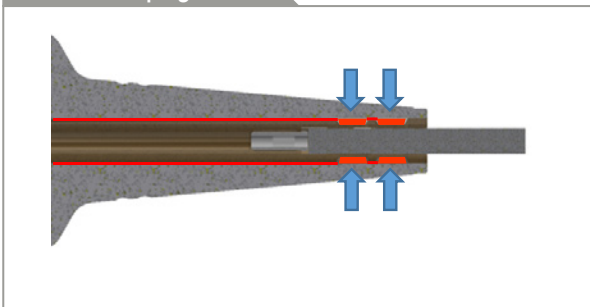
- Optimized for machining that requires high precision
- Enables challenging narrow and deep machining
- Products that require fine boring operations

Product Comparison



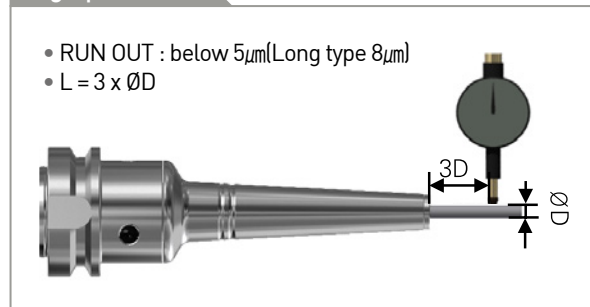
- Length and thickness are the same as those of DSC/M TYPE (if the tool projection length is 40mm, difference of α = around 2°)
- Longer gauge line and higher rigidity (versus the DSC/M TYPE)
- Ideal for mold machining due to its 3-degree taper shape

Stable Clamping force



- Maintains high clamping force and good accuracy by holding the tool at two points

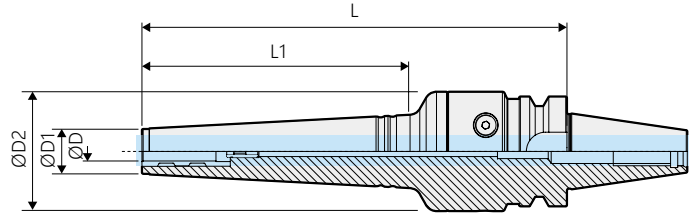
High-precision





BT-DHE/S

Slim hydraulic expansion chuck



- For more information on the related parts, see **26p**
- For more information on product features, see **24p**

	Model No.	ØD	ØD1	ØD2	L	L1	RPM	Run-out (Based on 3D)	Kg	Package weight (Kg)
BT30	BT30-DHE6S-115	6	16.8	50	115	50	25,000	5 µm	1.1	1.2
	BT30-DHE6S-180			50	180	115	25,000	8 µm	1.4	1.5
	BT30-DHE8S-115	8	18.8	50	115	50	25,000	5 µm	1.1	1.2
	BT30-DHE8S-180			50	180	115	25,000	8 µm	1.4	1.6
	BT30-DHE10S-120	10	20.8	50	120	55	25,000	5 µm	1.4	1.5
	BT30-DHE10S-180			50	180	115	25,000	8 µm	1.9	2.0
BT30-DHE12S-130	12	22.8	50	130	65	25,000	5 µm	1.2	1.3	
BT30-DHE12S-180			50	180	115	25,000	8 µm	1.6	1.7	
BT40	BT40-DHE6S-120	6	16.8	50	120	50	15,000	5 µm	1.7	1.8
	BT40-DHE6S-185			50	185	115	15,000	8 µm	2.0	2.2
	BT40-DHE8S-120	8	18.8	50	120	50	15,000	5 µm	2.0	2.1
	BT40-DHE8S-185			50	185	115	15,000	8 µm	2.0	2.2
	BT40-DHE10S-125	10	20.8	50	125	55	15,000	5 µm	1.6	1.7
	BT40-DHE10S-185			50	185	115	15,000	8 µm	2.0	2.2
	BT40-DHE12S-135	12	22.8	50	135	65	15,000	5 µm	1.8	1.9
	BT40-DHE12S-185			50	185	115	15,000	8 µm	2.2	2.3

C Internal coolant system installed.

Chuck

Arbor / Modular

Boring tool

Angular head

cBN/PCD

Smart factory

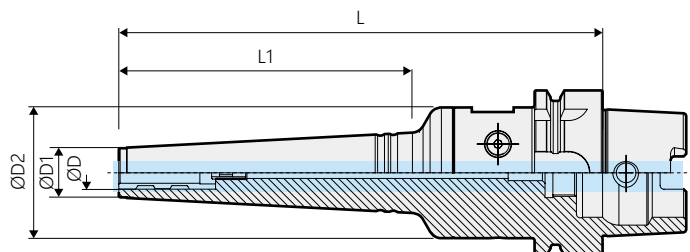
TAUMAX

OTHER



HSK-DHE/S

Slim hydraulic expansion chuck



- For more information on the related parts, see **26p**
- For more information on product features, see **24p**

Model No.	ØD	ØD1	ØD2	L	L1	RPM	Run-out (Based on 3D)	Kg	Package weight (Kg)
HSK63A	6	16.8	50	120	50	10,000	5 µm	1.4	1.6
				185	115		8 µm	1.7	1.9
	8	18.8		120	50		5 µm	1.4	1.7
				185	115		8 µm	1.8	2.0
	10	20.8		125	55		5 µm	1.5	1.7
				185	115		8 µm	1.8	2.0
	12	22.8		135	65		5 µm	1.8	1.9
				185	115		8 µm	1.8	2.1

C Internal coolant system installed.



DHE/S SPARE PART

Slim hydraulic expansion chuck related parts

Spare Part		Main component			
Type	Clamp bolt	Wrench	Type	Adjust screw	
Model No.	Images			Model No.	Images
BT30	DHE/S 6, 8, 10, 12	BTF1010	DHETW-5	DHE/S 6, 8, 10	DHE-M5 (ADJ)
BT40 HSK63A	DHE/S 6, 8, 10, 12	BTF1010		DHE/S 12	DHE-M10 (ADJ)



DHE

Hydraulic expansion chuck



G6.3	15,000	5 μ m	C			
G value	Max RPM	Run-out	Coolant System	Milling	Drilling	Reaming

Features

- Ideal for machining on molds, automotive parts, and precision parts due to its high precision machining operations
- Improves machining surface roughness due to the effective vibration resistance of its hydraulic seal
- Reduces replacement time and operator fatigue because the tool is removable using a T-wrench
- Tool clamping range: $\varnothing 6\text{--}\varnothing 32$

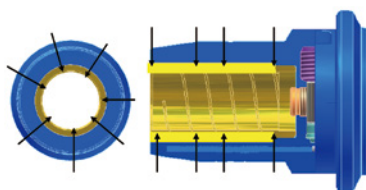
NAMING	BT40	—	DHE	—	20	—	140
	Spindle		Hydraulic Expansion Chuck		Tool Dia.		Length

Product Features

Its high precision not only increases the tool life of a cutting tool by reducing the wear of the tool but also improves machining surface roughness with the effect of vibration reduction by its hydraulic seal.

Completely closed inside construction (durability)

- The completely closed system of its inner diameter prevents dust, cutting oil, lubricant, and chips, etc. from penetrating it.
- Maintains clamping force and precision for a long time



SHANK	Grade	Max.RPM
BT50, SK50, HSK100A	G6.3	8,000
BT40, SK40, HSK63A	G6.3	10,000
BT30, SK30, HSK50A	G6.3	15,000

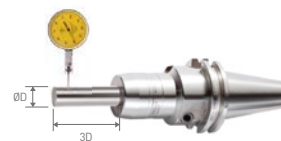


- C** Internal coolant system installed by default.
- c** Internal coolant system is optional. (HSK Shank)



High precision

- RUN OUT : below 5 μ m
- L = 3 x $\varnothing D$
- Shank : tolerance of $\varnothing D: h6$



Removal availability by using T-wrench tool

- Clamping / unclamping structure that only requires simple operation (convenience)
 - : Reduces operator fatigue
 - : Enhances the operation rate of equipment



Stable clamping force

Provides clamping force by fixing the space of the holder and tool with hydraulic pressure



Chuck

Arbor / Modular

Boring tool

Angular head

cBN/PCD

Smart factory

TAUMAX

OTHER



BT-DHE

Hydraulic expansion chuck



Fig.1

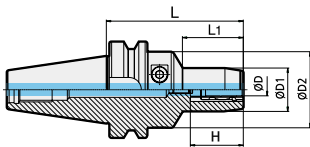


Fig.2

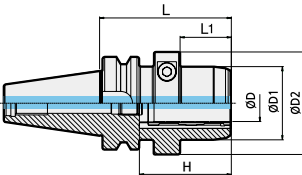


Fig.3

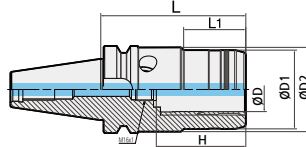
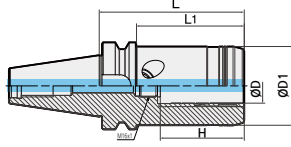


Fig.4



• H : Depth of tool insertion (Min. ~ Max.)

• For more information on product features, see **27p**

• For more information on the related parts, see **33p**

	Model No.	ØD	L	ØD1	ØD2	L1	H	ADJ	Fig.	Kg	Package weight (Kg)
BT30	BT30-DHE6-65	6	65	29	46	33	30~39.8	M5	1	0.7	0.8
	BT30-DHE8-65	8	65	31	46	33	30~39.8	M5	1	0.7	0.8
	BT30-DHE10-65	10	65	32	46	34	35~44.8	M5	1	0.7	0.8
	BT30-DHE12-70	12	70	35	46	34	41~50.8	M5	1	0.8	0.8
	BT30-DHE14-90	14	90	36	46	40	43~52.8	M5	1	1.0	1.1
	BT30-DHE16-90	16	90	40	46	45	46~55.8	M5	1	1.0	1.1
	BT30-DHE18-90	18	90	42	46	40	49~58.8	M5	1	1.1	1.2
	BT30-DHE20-90	20	90	44	46	45	49~58.8	M5	1	1.1	1.2
BT40	BT40-DHE6-90	6	90	29	50	40	30~39.8	M5	1	1.4	1.6
	BT40-DHE6-140	6	140	29	50	40	30~39.8	M5	1	2.2	2.5
	BT40-DHE8-90	8	90	31	50	40	30~39.8	M5	1	1.4	1.6
	BT40-DHE8-140	8	140	31	50	40	30~39.8	M5	1	2.2	2.5
	BT40-DHE10-90	10	90	33	50	40	35~44.8	M5	1	1.5	1.7
	BT40-DHE10-140	10	140	33	50	40	35~44.8	M5	1	2.2	2.4
	BT40-DHE12-90	12	90	35	50	40	41~50.8	M10	1	1.5	1.7
	BT40-DHE12-140	12	140	35	50	40	41~50.8	M10	1	2.3	2.5
	BT40-DHE14-90	14	90	36	50	40	43~52.8	M10	1	1.5	1.7
	BT40-DHE14-140	14	140	36	50	40	43~52.8	M10	1	2.2	2.4
	BT40-DHE16-90	16	90	40	50	45	46~55.8	M10	1	1.5	1.7
	BT40-DHE16-140	16	140	40	50	45	46~55.8	M10	1	2.2	2.5
	BT40-DHE18-90	18	90	42	50	45	49~58.8	M10	1	1.5	1.7
	BT40-DHE18-140	18	140	42	50	45	49~58.8	M10	1	2.2	2.5
	BT40-DHE20-90	20	90	44	50	47	49~58.8	M10	1	1.5	1.7
	BT40-DHE20-140	20	140	44	50	50	49~58.8	M10	1	2.3	2.5
	BT40-DHE25-90	25	90	50	70	35	58~67.8	M16	2	2.0	2.2
	BT40-DHE25-105	25	105	57	-	78	51~61	M16	4	2.0	2.2
	BT40-DHE25-140	25	140	57	-	113	51~61	M16	4	2.6	2.9
	BT40-DHE32-90	32	90	63	75	35	58~67.8	M16	2	2.3	2.5
BT40-DHE32-105	32	105	57	61	45	55~65	M16	3	2.4	2.6	
BT40-DHE32-140	32	140	57	61	45	55~65	M16	3	3.0	3.2	

C Internal coolant system installed.



HSK-DHE

Hydraulic expansion chuck



Fig.1

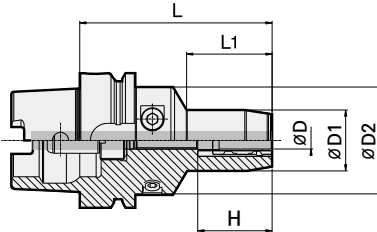
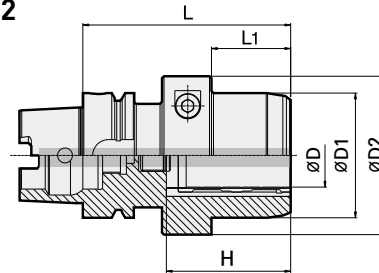


Fig.2



• **H** : Depth of tool insertion (Min.-Max.)

• For more information on product features, see **27p**

• For more information on the related parts, see **33p**

	Model No.	ØD	L	ØD1	ØD2	L1	H	ADJ	Fig.	RPM	Kg	Package weight (Kg)
HSK63A	HSK63A-DHE6-75	6	75	29	50	34	30~39.8	M5	1	10,000	1.0	1.2
	HSK63A-DHE8-75	8	75	31	50	34	30~39.8	M5	1	10,000	1.0	1.2
	HSK63A-DHE10-85	10	85	33	50	40	35~44.8	M5	1	10,000	1.2	1.4
	HSK63A-DHE12-90	12	90	35	50	40	41~50.8	M5	1	10,000	1.2	1.4
	HSK63A-DHE16-95	16	95	40	50	45	46~55.8	M10	1	10,000	1.3	1.5
	HSK63A-DHE20-100	20	100	44	50	50	49~58.8	M10	1	10,000	1.4	1.7
	HSK63A-DHE20-150	20	150	44	50	50	49~58.8	M10	1	10,000	2.2	2.4
	HSK63A-DHE25-110	25	110	50	70	48	56~67.8	M16	2	10,000	2.0	1.9
HSK100A	HSK100A-DHE20-105	20	105	44	50	50	49~58.8	M10	1	8,000	2.9	3.2
	HSK100A-DHE25-115	25	115	50	63	62	58~67.8	M16	1	8,000	3.2	3.6
	HSK100A-DHE32-115	32	115	63	75	62	58~67.8	M16	1	8,000	3.8	4.2

☐ Internal coolant system is optional.

For separate purchase

Internal coolant system



Classification by shank

HSK50	HSK50A-CNS
HSK63	HSK63A-CNS
HSK100	HSK100A-CNS



SK-DHE

Hydraulic expansion chuck

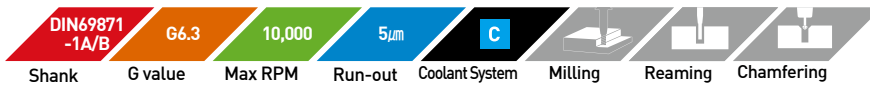
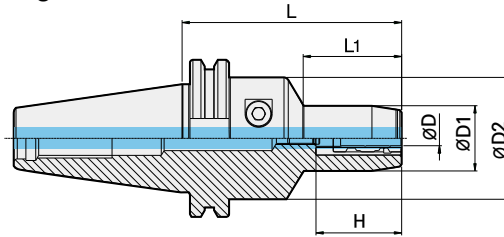


Fig.1



• H : Depth of tool insertion (Min.~Max.)

• For more information on product features, see **27p**

• For more information on the related parts, see **33p**

	Model No.	ØD	L	ØD1	ØD2	L1	H	ADJ	Fig.	RPM	Kg	Package weight (Kg)
SK40	SK40-DHE6-90	6	90	29	50	40	30-39.8	M5	1	10,000	1.4	1.6
	SK40-DHE8-90	8	90	31	50	40	30-39.8	M5	1	10,000	1.4	1.6
	SK40-DHE10-90	10	90	33	50	40	35-44.8	M5	1	10,000	1.5	1.7
	SK40-DHE12-90	12	90	35	50	40	41~50.8	M10	1	10,000	1.5	1.7
	SK40-DHE12-140	12	140	35	50	40	41~50.8	M10	1	10,000	2.1	2.3
	SK40-DHE12-90	12	90	35	50	40	41~50.8	M10	1	10,000	1.5	1.7
	SK40-DHE12-140	12	140	35	50	40	41~50.8	M10	1	10,000	2.1	2.3
	SK40-DHE14-90	14	90	36	50	40	43~52.8	M10	1	10,000	1.4	1.6
	SK40-DHE16-90	16	90	40	50	45	46~55.8	M5	1	10,000	1.5	1.7
	SK40-DHE18-90	18	90	42	50	45	49~58.8	M5	1	10,000	1.5	1.7
	SK40-DHE20-90	20	90	44	50	50	49~58.8	M10	1	10,000	1.5	1.7
SK40-DHE20-140	20	140	44	50	50	49~58.8	M10	1	10,000	2.1	2.4	
SK50	SK50-DHE12-90	12	90	35	50	40	41~50.8	M10	1	8,000	3.2	3.5
	SK50-DHE14-90	14	90	36	50	40	43~52.8	M10	1	8,000	3.2	3.5
	SK50-DHE16-90	16	90	40	50	45	46~55.8	M10	1	8,000	3.3	3.5
	SK50-DHE18-90	18	90	42	50	40	49~58.8	M10	1	8,000	3.2	3.5
	SK50-DHE20-90	20	90	44	50	47	49~58.8	M10	1	8,000	3.2	3.5

C Internal coolant system installed.

Chuck

Arbor / Modular

Boring tool

Angular head

cBN/PCD

Smart factory

TAUMAX

OTHER

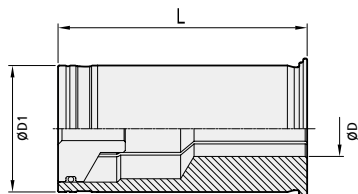


DHC Collet (general type & waterproof type)

DHE Collet(General type) / DHE Collet(waterproof type)

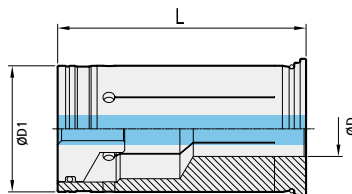


Fig.1



C This product does not support the internal coolant system.

Fig.2



C Internal coolant system installed.

• Other sizes are customizable

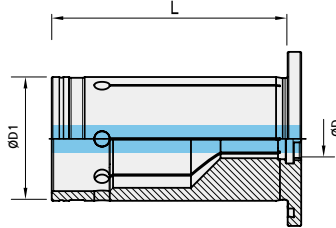
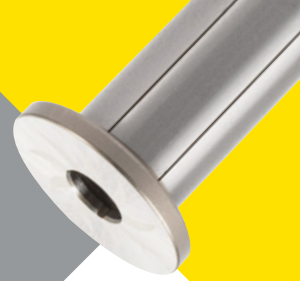
Model No. (general type)	ØD	ØD1	L	Fig.	Kg
DHC12-3	3	12	47	1	0.06~ 0.08
DHC12-4	4	12	47	1	
DHC12-5	5	12	47	1	
DHC12-6	6	12	47	1	
DHC12-8	8	12	47	1	
DHC20-3	3	20	52	1	0.04~ 0.06
DHC20-4	4	20	52	1	
DHC20-5	5	20	52	1	
DHC20-6	6	20	52	1	
DHC20-7	7	20	52	1	
DHC20-8	8	20	52	1	
DHC20-9	9	20	52	1	
DHC20-10	10	20	52	1	
DHC20-11	11	20	52	1	
DHC20-12	12	20	52	1	
DHC20-14	14	20	52	1	0.2~ 0.5
DHC20-16	16	20	52	1	
DHC32-6	6	32	63	1	
DHC32-8	8	32	63	1	
DHC32-10	10	32	63	1	
DHC32-12	12	32	63	1	
DHC32-14	14	32	63	1	
DHC32-16	16	32	63	1	
DHC32-18	18	32	63	1	
DHC32-19	19	32	63	1	
DHC32-20	20	32	63	1	
DHC32-25	25	32	63	1	

Model No. (waterproof type)	ØD	ØD1	L	Fig.	Kg
DHC12-3(P)	3	12	47	2	0.04
DHC12-4(P)	4	12	47	2	
DHC12-5(P)	5	12	47	2	
DHC12-6(P)	6	12	47	2	
DHC12-8(P)	8	12	47	2	
DHC20-3(P)	3	20	52	2	0.06~ 0.1
DHC20-4(P)	4	20	52	2	
DHC20-5(P)	5	20	52	2	
DHC20-6(P)	6	20	52	2	
DHC20-7(P)	7	20	52	2	
DHC20-8(P)	8	20	52	2	
DHC20-9(P)	9	20	52	2	
DHC20-10(P)	10	20	52	2	
DHC20-11(P)	11	20	52	2	
DHC20-12(P)	12	20	52	2	
DHC20-14(P)	14	20	52	2	0.2~ 0.3
DHC20-16(P)	16	20	52	2	
DHC32-6(P)	6	32	63	2	
DHC32-8(P)	8	32	63	2	
DHC32-10(P)	10	32	63	2	
DHC32-12(P)	12	32	63	2	
DHC32-14(P)	14	32	63	2	
DHC32-16(P)	16	32	63	2	
DHC32-18(P)	18	32	63	2	
DHC32-19(P)	19	32	63	2	
DHC32-20(P)	20	32	63	2	
DHC32-25(P)	25	32	63	2	



DHJ Collet (jet coolant)

DHJ JET Coolant Collet



Model No.	ØD	ØD1	L	Kg	Package weight (Kg)
DHJ20-6	6	20	50	0.1	0.1
DHJ20-8	8	20	50	0.14	0.14
DHJ20-10	10	20	50	0.1	0.1
DHJ20-12	12	20	50	0.1	0.1
DHJ20-14	14	20	50	0.08	0.08
DHJ20-16	16	20	50	0.08	0.08

C Internal coolant system installed.



DHE SPARE PART

Hydraulic expansion chuck related parts

Spare Part		Main component			
Type	Images	Clamp bolt	Wrench	Type	Adjustment screw
BT30 / SK30 / HSK50	DHE 6, 8, 10, 12	BTF1010	DHETW-5	DHE 6, 8, 10	DHE-M5 (ADJ)
	DHE 14, 16, 18, 20	BTF1010			
BT40 / BT50 / SK40 / SK50 / HSK63A / HSK100A	DHE 6, 8, 10, 12, 14, 16, 18, 20	BTF1010	DHETW-6	DHE 12, 14, 16, 18, 20	DHE-M10 (ADJ)
	DHE 25, 32	BTF1212-1.5			



DZC

Zero fit collet



≤2μm
C
 Run-out Coolant System

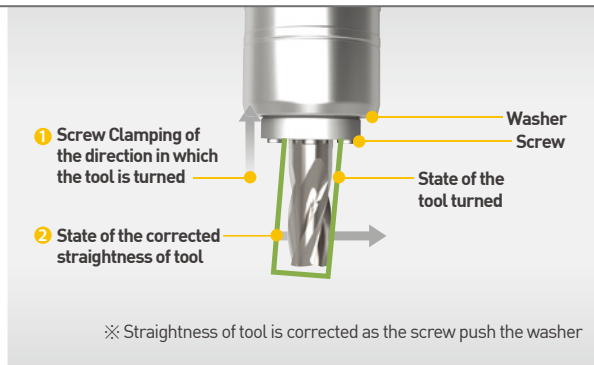
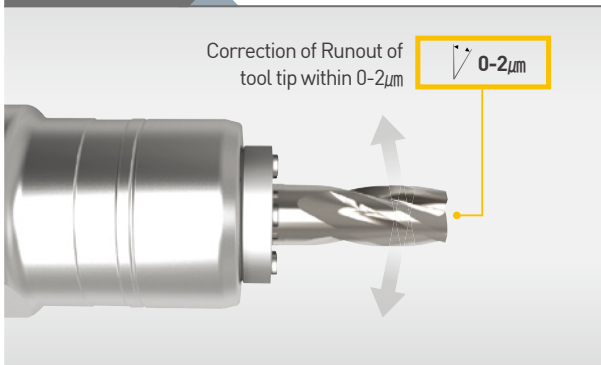
Features

- Correcting 10 - 20μm runout generated at tool tip to 0-2μm.
- Improves the runout and straightness of end tools.
 - Improves the surface roughness and quality of the machining area.
 - Improves the accuracy of boring hole dimension.
 - Improves the tool life of end tools.

MACHINE	DZC	20	—	10
	Zero Fit Collet	Collet size		Tool Dia.



Main features



Comparison test

<p>Runout of tool tip 10-20 μm</p> <p>Surface roughness Rz 11.064</p> <p>Tool fracture occurred</p>	<p>Runout of tool tip 0-2 μm</p> <p>Surface roughness Rz 6.688</p> <p>No fracture occurred</p>
--	---

PCD reamer hole machining test result

— Zero fit top 0° — Zero fit top 90°
— General top 0° — General top 90°

Hole diameter deviation in the direction of X, Y after machining(μm)

Wobble of the common shelf = 10-20μm

Wobble of the zero fit shelf = 0-2μm

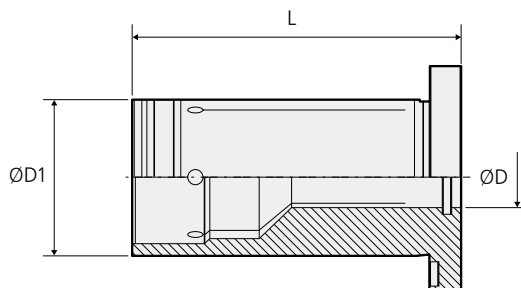
The number of machining holes

Hole actual deviation as Machining result(mm)		
Based on Ø8	Zero Fit	General
	+0.003	+0.02



DZC

Zero fit collet



	Model No.	ØD1	ØD	L
DZC20	DZC20-6	6	20	56.5
	DZC20-8	8	20	56.5
	DZC20-10	10	20	56.5
	DZC20-12	12	20	56.5
	DZC20-14	14	20	56.5
	DZC20-16	16	20	56.5
DZC32	DZC32-6	6	32	67.5
	DZC32-8	8	32	67.5
	DZC32-10	10	32	67.5
	DZC32-12	12	32	67.5
	DZC32-16	16	32	67.5
	DZC32-20	20	32	67.5
	DZC32-25	25	32	67.5

C This product does not support the internal coolant system.

※ Precautions

- Runout is adjusted by clamping the runout adjustment screw even with a small force.
- Excessively clamping the runout adjustment screw can deform inner parts. (Don't use excessive force when clamping. Torque: less than 600cN·m recommended)
- If the runout adjustment screw is clamped using excessive force, all six screws must be completely unclamped and adjusted again.

Chuck

Arbor / Modular

Boring tool

Angular head

cBN/PCD

Smart factory

TAUMAX

OTHER



DSC

Shrinking Chuck



G2.5	25,000	5 μ m	C				
G value	Max RPM	Run-out	Coolant System	Milling	Drilling	Reaming	Chamfering

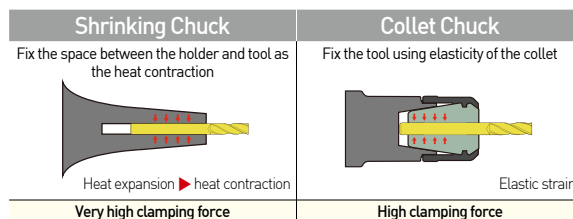
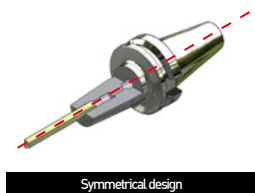
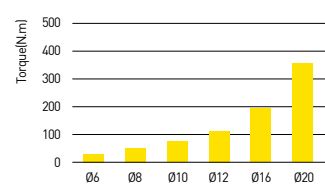
Features

- Uses special steel specially heat-treated
- Enables anyone to perform high-precision tightening and machining
- Ensure a long tool life and enhanced machining accuracy by minimizing interference and tool protrusion length for deep groove machining
- Boring range : \varnothing 3- \varnothing 20

NAMING	BT50	DSC	6	S	165	S
	Shank Shape	Holder type	Tool Dia.	Type	Length	Special
	BT HSK SK	DSC : Shrinking chuck		S : Slim		S : Curve type
	ST CS CM	SLK : 2piece holder		M : Middle		NON : General
				NON : General		



High clamping force



- Increase of 30% clamping force versus hydraulic expansion chuck
- Definite power transmission · Runout (\leq 0.003mm)

Slim type series

Straight type

Used by combining with various holders such as hydraulic expansion chuck, milling chuck, and collet chuck.

Mono type

Used with high precision as integral types

2piece type

Holder+ collet connection shape
Connecting the holder and collet by the bolt tightening method



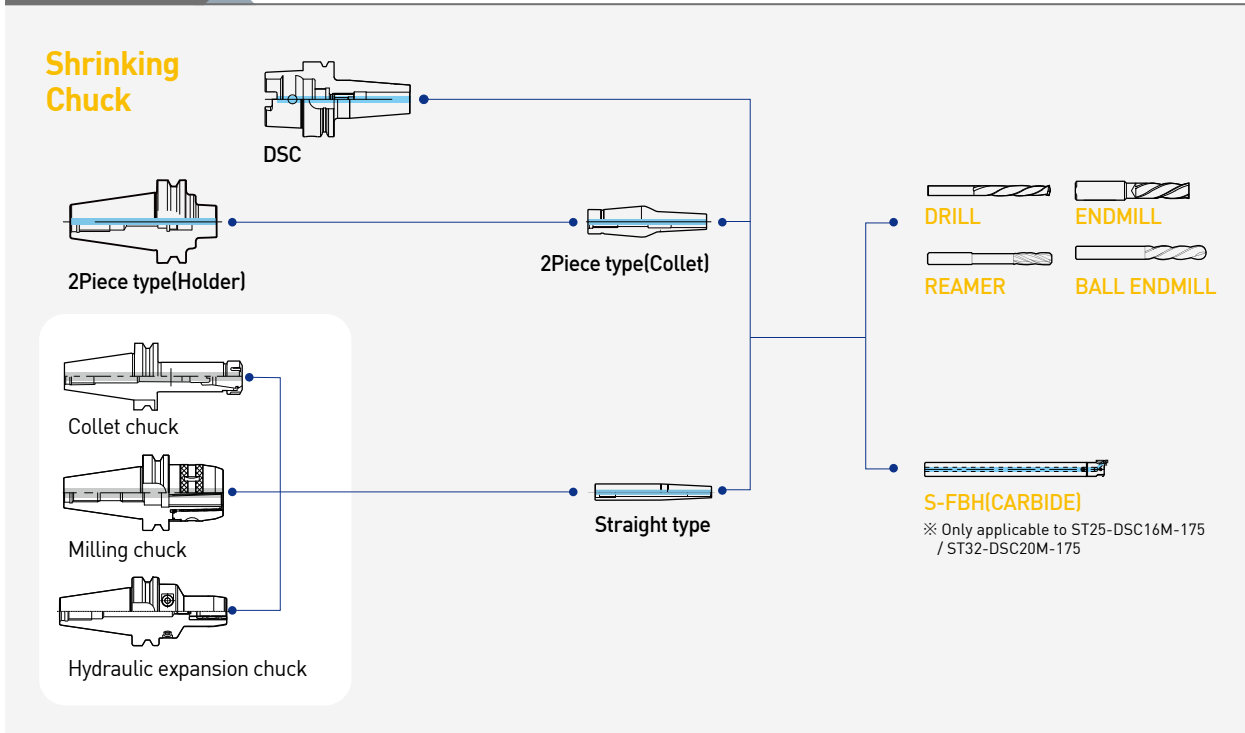
Tool tightening tolerance

Tool Shank	Tool Shank Tolerance[h6]	Tool Shank	Tool Shank Tolerance[h6]	Tool Shank	Tool Shank Tolerance[h6]	Tool Shank	Tool Shank Tolerance[h6]
Ø3	0~-0.008	Ø6	0~-0.008	Ø12	0~-0.011	Ø25	0~-0.013
Ø4	0~-0.009	Ø8	0~-0.009	Ø16	0~-0.011	Ø32	0~-0.016
Ø5	0~-0.011	Ø10	0~-0.011	Ø20	0~-0.013		

Min. tool insertion depth

Inner diameter[Ø]	Type	Ø6	Ø8	Ø10	Ø12	Ø16	Ø20	Ø25	Ø32
Min. tool insertion depth	Slim	18	24	30	30	-	-	-	-
	Medium	18	24	30	30	32	40	-	-
	General	26	26	32	37	37	40	42	52

DSC MAP



Chuck

Arbor / Modular

Boring tool

Angular head

cBN/PCD

Smart factory

TAUMAX

OTHER



MONO CURVE TYPE

- Integral DSC of outstanding accuracy and rigidity balance characteristics
- Long but rigid holder design



2PIECE TYPE

2Piece types enable various machining operations by collet replacement and provide convenience in tool management and use based on easy and fast assembly using tightening bolts.

Shape	Accuracy	TYPE	
		<p>Slim type</p>	<p>Medium type</p>
Holder+collet connection shape Connecting the holder and collet by the bolt tightening method			

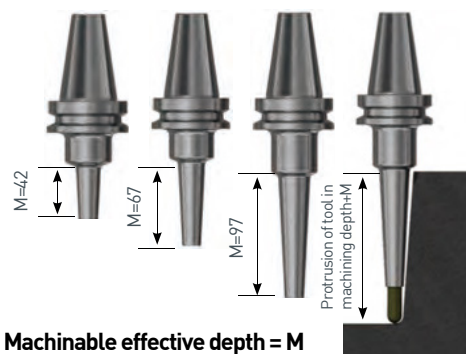
Various collet shapes - 28 in total	Coolant system
<p>Tool management and purchase expenses are reduced by changing and using only collet in one body</p>	<p>Coolant type 60-degree angle adjustable</p>



MONO TYPE

Shape	Accuracy	TYPE	
<p>3° taper Thickness t</p>	<p>Run-out 3µm 3xD</p>	<p>1.5t Slim type</p>	<p>2~4.5t Medium type</p>

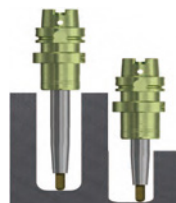
- ※ Ensures good rigidity by using special steel instead of general steel and maintains high precision due to its excellent thermal resistance even when it is used more than 5,000 times.
- ※ Enables stable cutting and good surface roughness due to its high rigidity
- ※ Provides a long tool life due to its high precision



STRAIGHT TYPE

Shape	Accuracy	TYPE	
<p>3° taper Thickness t</p> <p>Collet chuck Hydraulic expansion chuck Milling chuck</p>	<p>Run-out 3µm 3xD</p>	<p>1.5t Slim type</p>	<p>2~4.5t Medium type</p>
		Used by combining with various holders such as hydraulic expansion chuck, milling chuck, and collet chuck, etc.	

Examples



- ※ Straight types used by combining with various holders such as hydraulic expansion chuck and collet chuck, etc. maintain high precision and help enable various machining operations at an affordable price.
- ※ There are 20 types of shanks that can be used according to work situations

Chuck

Arbor / Modular

Boring tool

Angular head

cBN/PCD

Smart factory

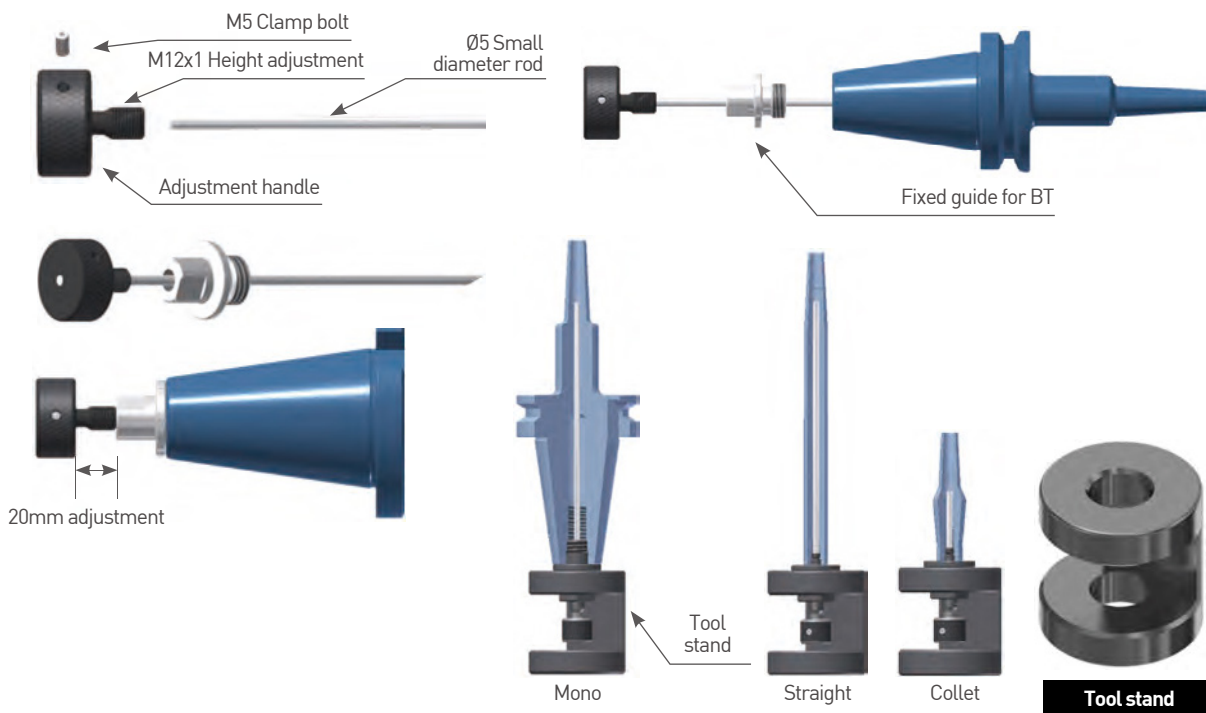
TAUMAX

OTHER



Adjustment method of tool insertion depth

1. Prepare a $\varnothing 5$ Pin suitable for tool length
2. Combine the $\varnothing 5$ Pin and adjustment handler and fix them with a clamp bolt
3. Fix the fixing guide to the tool and put the tightened adjustment handler therein.
4. Put it on the tool stand and measure tool insertion depth



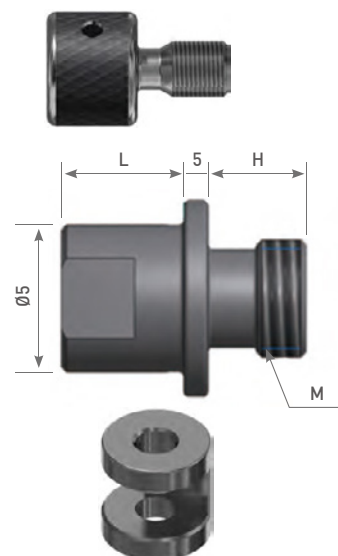
Accessory

Name	Designation
Adjustment handler	CTH-01

Name	Designation	$\varnothing D$	L	H	M
Fixing guide	SG-M10	25	25	10	M10
	SG-M12			12	M12
	SG-M16			14	M16
	SG-M24			20	M24

Name	Designation
Tool stand	TS-DSC

Name	Designation
$\varnothing 5$ Small-diameter rod	Individual purchase

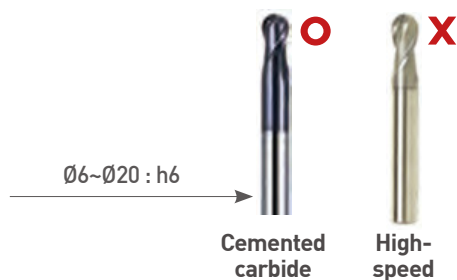




Precautions for use

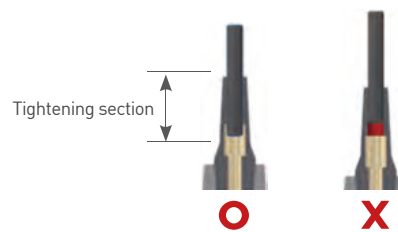
Tools to use

- Use cemented carbide tools.
- High-speed tools may not be disassembled.
- Using an excessive tolerance tool affects clamping force, causing an accident.



Precautions in case of tightening a tool

- Maintain clean state by removing rust, dust, cutting oil, etc. generated by corrosion of the inner diameter of the chuck before tool tightening.
- When tightening a tool, tighten it under the tightening section.
- Tool tightening in the middle of the tightening section affects accuracy and durability.
- When tightening a tool, touching the bottom surface affects accuracy.



High-frequency heating precautions

- When tightening/disassembling a tool, it is recommended that slim-type programmed shrink fit devices be used.
- Using devices with no slim-type program may cause overheating. (Overheating may affect the product durability, service life, and accuracy.)

Storage method

- When the shrink fit chuck is not used, the tool should be separated from the chuck. (Long-time connection may affect the service life of the product.)
- After using the shrink fit chuck, be sure to remove moisture and use inhibited oil and rust-preventing spray to prevent rust from occurring. (Less rust occurs compared to general steel as special steel is used; however, long-time non-use may cause rust occurrence.)

Components for separate sale



Shrinking device

TAUMAX shrink fit equipment MH-200

Features

- Enables a maximum of 30-time consecutive heating
- Enables the common use of steel, SUS material holders
- Enables the use of all standard taper tools simply by adapter flange replacement
- Enables replacement of heating coils with diameters of Ø25, Ø30, Ø40, Ø55
- Enables chuck overheating prevention and manual tool cooling through setting

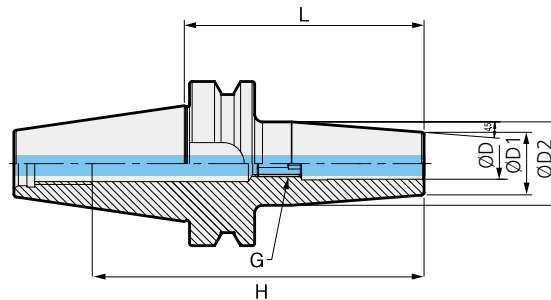
For more information on the product features, see [289p](#).





BT-DSC

Shrinking Chuck



• For more information on product features, see **36p**.

• **H** : Depth of tool insertion

• For more information on the related parts (adjustment screw), see **51p**.

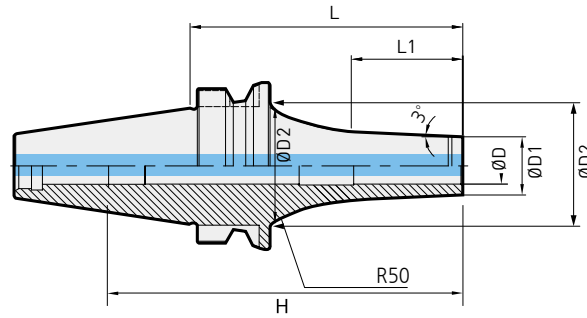
	Model No.	ØD	L	ØD1	ØD2	H	G	RPM	Kg	Package weight (Kg)
BT30	BT30-DSC3-60	3	60	11	18.5	82	-	25,000	0.4	0.5
	BT30-DSC4-60	4	60	13	20.5	82	-	25,000	0.4	0.5
BT40	BT40-DSC6-90	6	90	21	27	36	M5	20,000	1.1	1.3
	BT40-DSC6-120	6	120	21	27	36	M5	20,000	1.2	1.5
	BT40-DSC6-160	6	160	21	27	36	M5	20,000	1.4	1.7
	BT40-DSC8-90	8	90	21	27	36	M5	20,000	1.1	1.3
	BT40-DSC8-120	8	120	21	27	36	M5	20,000	1.2	1.4
	BT40-DSC8-160	8	160	21	27	36	M5	20,000	1.4	1.7
	BT40-DSC10-90	10	90	24	32	42	M8	20,000	1.1	1.3
	BT40-DSC10-120	10	120	24	32	42	M8	20,000	1.3	1.6
	BT40-DSC10-160	10	160	24	32	42	M8	20,000	1.6	1.8
	BT40-DSC12-90	12	90	24	32	47	M8	20,000	1.1	1.3
	BT40-DSC12-120	12	120	24	32	47	M8	20,000	1.3	1.5
	BT40-DSC12-160	12	160	24	32	47	M8	20,000	1.6	1.8
	BT40-DSC16-90	16	90	27	34	50	M12	20,000	1.2	1.4
	BT40-DSC16-120	16	120	27	34	50	M12	20,000	1.3	1.6
	BT40-DSC16-160	16	160	27	34	50	M12	20,000	1.7	1.9
	BT40-DSC20-90	20	90	33	42	52	M12	20,000	1.3	1.5
BT40-DSC20-120	20	120	33	42	52	M12	20,000	1.5	1.8	
BT40-DSC20-160	20	160	33	42	52	M12	20,000	2.0	2.3	

C Internal coolant system installed.



BT-DSC/M MONO CURVE TYPE

Shrinking Chuck



• H : Depth of tool insertion

※ Adjustment screws cannot be used for this product.

• For more information on product features, see **36p**

• For more information on the related parts, see **51p**

	Model No.	ØD	L	ØD1	ØD2	L1	H	RPM	Kg	Package weight (Kg)
BT30	BT30-DSC3M-75S	3	75	8	25	29.8	97	25,000	0.4	0.5
	BT30-DSC4M-75S	4	75	10	25	31.8	97	25,000	0.4	0.5
	BT30-DSC6M-75S	6	75	12	30	28.9	97	25,000	0.5	0.5
	BT30-DSC8M-75S	8	75	14	32	28.9	97	25,000	0.5	0.5
	BT30-DSC10M-75S	10	75	16	32	30.7	45	25,000	0.5	0.5
	BT30-DSC12M-75S	12	75	19	32	33.8	45	25,000	0.5	0.5

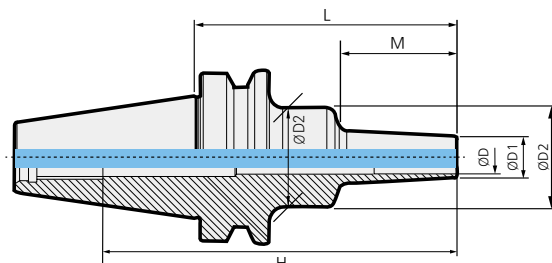
C Internal coolant system installed.

Chuck
Arbor / Modular
Boring tool
Angular head
cBN/PCD
Smart factory
TAUMAX
OTHER



BT-DSC/M MONO TYPE

Shrinking Chuck



• **H** : Depth of tool insertion

• For more information on product features, see **36p**

• For more information on the related parts, see **51p**

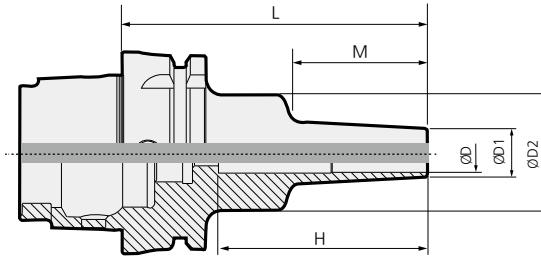
	Model No.	ØD	L	ØD1	ØD2	M	H	RPM	Kg	Package weight (Kg)
BT40	BT40-DSC3M-95	3	95	8	26	42	128	20,000	1.1	1.2
	BT40-DSC4M-95	4	95	8	26	42	128	20,000	1.1	1.1
	BT40-DSC6M-95	6	95	10	26	42	128	20,000	1.0	1.2
	BT40-DSC6M-120	6	120	10	26	67	153	20,000	1.0	1.2
	BT40-DSC6M-160	6	160	10	36	97	193	20,000	1.2	1.3
	BT40-DSC8M-95	8	95	13	36	42	128	20,000	1.3	1.4
	BT40-DSC8M-120	8	120	13	36	67	153	20,000	1.3	1.5
	BT40-DSC8M-160	8	160	13	36	97	193	20,000	1.3	1.5
	BT40-DSC10M-95	10	95	16	36	42	128	20,000	1.1	1.3
	BT40-DSC10M-120	10	120	16	36	67	153	20,000	1.1	1.4
	BT40-DSC10M-160	10	160	16	36	97	193	20,000	1.3	1.6
	BT40-DSC12M-95	12	95	19	36	42	128	20,000	1.1	1.2
	BT40-DSC12M-120	12	120	19	36	67	153	20,000	1.2	1.4
	BT40-DSC12M-160	12	160	19	36	97	193	20,000	1.4	1.6
	BT40-DSC16M-95	16	95	24	50	42	47	20,000	1.3	1.5
	BT40-DSC16M-120	16	120	24	50	67	47	20,000	1.4	1.6
BT40-DSC16M-160	16	160	24	50	97	47	20,000	1.7	2.0	
BT40-DSC20M-95	20	95	29	50	42	55	20,000	1.3	1.5	
BT40-DSC20M-120	20	120	29	50	67	55	20,000	1.5	1.7	
BT40-DSC20M-160	20	160	29	50	97	55	20,000	1.9	2.1	
BT50	BT50-DSC6M-110	6	110	10	26	42	163	15,000	3.5	3.8
	BT50-DSC6M-160	6	160	10	36	97	213	15,000	3.6	4.0
	BT50-DSC8M-110	8	110	13	36	42	163	15,000	3.7	4.0
	BT50-DSC8M-160	8	160	13	36	97	213	15,000	3.7	4.1
	BT50-DSC10M-110	10	110	16	36	42	163	15,000	3.7	4.0
	BT50-DSC10M-160	10	160	16	36	97	213	15,000	3.7	4.1
	BT50-DSC12M-110	12	110	19	36	42	163	15,000	3.7	4.0
	BT50-DSC12M-160	12	160	19	50	97	213	15,000	4.0	4.4
	BT50-DSC16M-110	16	110	24	50	42	163	15,000	3.9	4.2
	BT50-DSC16M-160	16	160	24	50	97	213	15,000	4.1	4.5
	BT50-DSC20M-110	20	110	29	50	42	55	15,000	3.9	4.2
	BT50-DSC20M-160	20	160	29	50	97	55	15,000	4.2	4.6

C Internal coolant system installed.



HSK-DSC/M MONO TYPE

Shrinking Chuck



• **H** : Depth of tool insertion

※ Adjustment screws cannot be used for this product.

• For more information on product features, see **36p**

• For more information on the related parts, see **51p**

Model No.	ØD	L	ØD1	ØD2	M	H	RPM	Kg	Package weight (Kg)
HSK63A-HSK63A-DSC6M-95	6	95	10	26	42	73	20,000	0.7	0.9
HSK63A-HSK63A-DSC8M-95	8	95	13	36	42	39	20,000	0.8	1.0
HSK63A-HSK63A-DSC10M-120	10	120	16	36	67	45	20,000	0.8	1.0
HSK63A-HSK63A-DSC12M-120	12	120	19	36	67	45	20,000	0.9	1.1
HSK63A-HSK63A-DSC16M-120	16	120	24	50	67	47	20,000	1.1	1.3

ⓐ Internal coolant system is optional.

For separate purchase



Classification by shank	
HSK50	HSK50A-CNS
HSK63	HSK63A-CNS
HSK100	HSK100A-CNS

Chuck

Arbor / Modular

Boring tool

Angular head

cBN/PCD

Smart factory

TAUMAX

OTHER

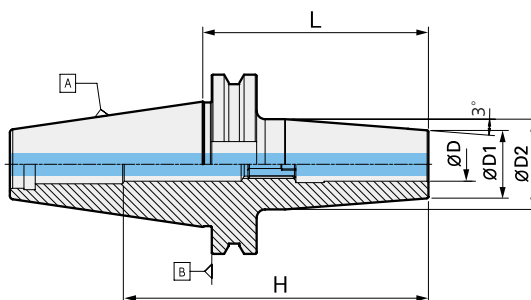


SK-DSC/M MONO TYPE

Shrinking Chuck



DIN69871 -1A/B	G2.5	20,000	3 μ m	C	Milling	Drilling	Reaming	Chamfering
Shank	G value	Max RPM	Run-out	Coolant System				



• **H** : Depth of tool insertion

※ Adjustment screws cannot be used for this product.

• For more information on product features, see **36p**.

• For more information on the related parts, see **51p**.

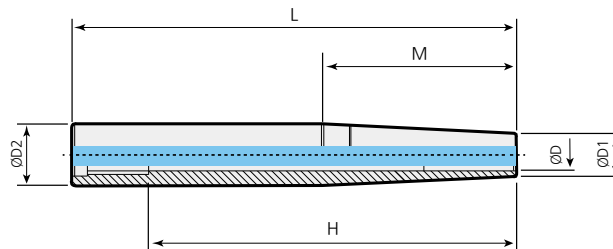
Model No.	ØD	L	ØD1	ØD2	M	H	RPM	Kg	Package weight (Kg)
SK40-DSC6M-95	6	95	10	26	42	131	20,000	0.8	1.0
SK40-DSC6M-120	6	120	10	26	67	156	20,000	1.0	1.2
SK40-DSC8M-95	8	95	13	36	42	131	20,000	1.4	1.6
SK40-DSC8M-120	8	120	13	36	67	156	20,000	1.0	1.2
SK40-DSC10M-95	10	95	16	36	42	131	20,000	1.0	1.2
SK40-DSC10M-120	10	120	16	36	67	156	20,000	1.0	1.3
SK40-DSC12M-95	12	95	19	36	42	131	20,000	1.0	1.2
SK40-DSC12M-120	12	120	19	36	67	156	20,000	1.1	1.3
SK40-DSC16M-95	16	95	24	50	42	47	20,000	1.3	1.5
SK40-DSC16M-120	16	120	24	50	67	47	20,000	1.4	1.6
SK40-DSC20M-95	20	95	29	50	42	55	20,000	1.3	1.5
SK40-DSC20M-120	20	120	29	50	67	55	20,000	1.4	1.6

C Internal coolant system installed.



ST-DSC/M

Straight shank shrinking chuck



• H : Depth of tool insertion

• For more information on product features, see **36p**

• For more information on the related parts, see **51p**

Model No.	ØD	L	ØD1	ØD2	M	H	Kg	Package weight (Kg)
ST16-DSC6M-115	6	115	10	16	50	95	0.1	0.2
ST16-DSC6M-140	6	140	10	16	60	120	0.1	0.2
ST20-DSC6M-175	6	175	10	20	95	155	0.2	0.3
ST20-DSC8M-145	8	145	13	20	70	125	0.2	0.3
ST20-DSC10M-120	10	120	16	20	50	45	0.2	0.3
ST25-DSC8M-175	8	175	13	25	105	155	0.4	0.5
ST25-DSC10M-145	10	145	16	25	75	45	0.4	0.5
ST25-DSC10M-175	10	175	16	25	105	45	0.4	0.5
ST25-DSC12M-120	12	120	19	25	50	45	0.3	0.4
ST25-DSC12M-150	12	150	19	25	80	45	0.4	0.4
ST25-DSC16M-175	16	175	24	25	50	47	0.5	0.6
ST32-DSC20M-175	20	175	29	32	50	55	0.8	0.9

ST16, ST20, ST25, ST32

C Internal coolant system installed.

Chuck

Arbor / Modular

Boring tool

Angular head

cBN/PCD

Smart factory

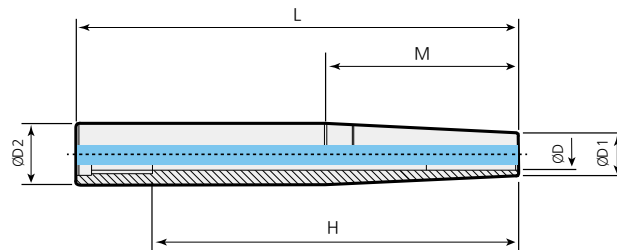
TAUMAX

OTHER



ST-DSC/S

Straight shank shrinking chuck



- **H** : Depth of tool insertion
- For more information on product features, see **36p**.
- For more information on the related parts, see **51p**.

	Model No.	ØD	L	ØD1	ØD2	M	H
ST16, ST20, ST32	ST16-DSC6S-115	6	115	9	16	55	95
	ST16-DSC6S-140	6	140	9	16	70	120
	ST16-DSC8S-115	8	115	11	16	50	95
	ST20-DSC6S-175	6	175	9	20	105	155
	ST20-DSC8S-175	8	175	11	20	85	155
	ST20-DSC10S-145	10	145	13	20	75	77
	ST20-DSC12S-120	12	120	15	20	50	52
	ST32-DSC12S-315	12	315	15	32	185	295

C Internal coolant system installed.

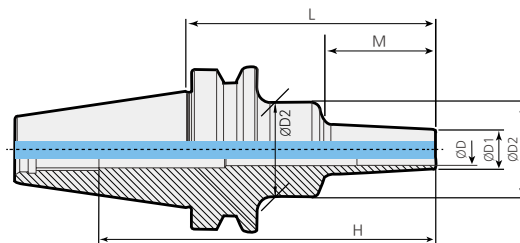


BT-DSC/S MONO SLIM TYPE

Shrinking chuck



MAS 403-BT
G2.5
25,000
3 μ m
C
Milling
Drilling
Reaming
Chamfering



• H : Depth of tool insertion

※ Adjustment screws cannot be used for this product.

• For more information on product features, see **36p**

• For more information on the related parts, see **51p**

	Model No.	ØD	L	ØD1	ØD2	M	H	RPM	Kg	Package weight (Kg)
BT30	BT30-DSC6S-60	6	60	9	20	22	82	25,000	0.4	0.5
	BT30-DSC6S-80	6	80	9	20	42	102	25,000	0.5	0.5
	BT30-DSC6S-120	6	120	9	25	67	142	25,000	0.5	0.6
BT40	BT40-DSC6S-95	6	95	9	26	42	128	20,000	1.0	1.2
	BT40-DSC6S-120	6	120	9	26	67	153	20,000	1.0	1.2
	BT40-DSC6S-160	6	160	9	36	97	193	20,000	1.2	1.4
	BT40-DSC8S-95	8	95	11	36	42	128	20,000	1.1	1.3
	BT40-DSC8S-120	8	120	11	36	67	153	20,000	1.1	1.3
	BT40-DSC8S-160	8	160	11	36	97	193	20,000	1.2	1.5
	BT40-DSC10S-95	10	95	13	36	42	128	20,000	1.0	1.2
	BT40-DSC10S-120	10	120	13	36	67	153	20,000	1.1	1.3
	BT40-DSC10S-160	10	160	13	36	97	193	20,000	1.2	1.5
	BT40-DSC12S-95	12	95	15	36	42	128	20,000	1.1	1.3
	BT40-DSC12S-120	12	120	15	36	67	153	20,000	1.1	1.3
	BT40-DSC12S-160	12	160	15	36	97	193	20,000	1.2	1.4
BT50	BT50-DSC6S-110	6	110	9	26	42	166	15,000	3.5	3.8
	BT50-DSC6S-160	6	160	9	36	97	216	15,000	3.6	4.0
	BT50-DSC8S-110	8	110	11	36	42	166	15,000	3.6	3.9
	BT50-DSC8S-160	8	160	11	36	97	216	15,000	3.6	4.0
	BT50-DSC10S-110	10	110	13	36	42	166	15,000	3.6	3.9
	BT50-DSC10S-160	10	160	13	36	97	216	15,000	3.6	4.0
	BT50-DSC12S-110	12	110	15	36	42	166	15,000	3.6	3.9
	BT50-DSC12S-160	12	160	15	36	97	216	15,000	3.7	4.1

C Internal coolant system installed.

Chuck

Arbor / Modular

Boring tool

Angular head

cBN/PCD

Smart factory

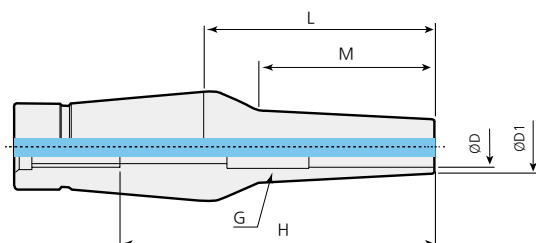
TAUMAX

OTHER



CS/CM 2PIECES TYPE

Shrinking chuck



• **H** : Depth of tool insertion

※ Adjustment screws cannot be used for this product.

※ The conventional order receiving to be converted after the current stock runs out.

• For more information on product features, see **36p**.

• For more information on the related parts, see **51p**.

Model No.	ØD	L	ØD1	M	H	Kg	Package weight (Kg)
CS12-6-35	6	35	9	22	55	0.1	0.2
CS12-6-80	6	80	9	67	100	0.2	0.2
CS12-6-110	6	110	9	97	130	0.2	0.3
CS12-8-35	8	35	11	22	55	0.1	0.2
CS12-8-110	8	110	11	97	130	0.3	0.3
CS12-10-35	10	35	13	22	45	0.1	0.2
CS12-10-80	10	80	13	67	65	0.2	0.3
CS12-10-110	10	110	13	97	65	0.3	0.4
CS12-12-35	12	35	15	22	45	0.1	0.2
CS12-12-55	12	55	15	42	49.5	0.2	0.2
CS12-12-80	12	80	15	67	65	0.2	0.3
CS12-12-110	12	110	15	97	65	0.3	0.4

Model No.	ØD	L	ØD1	M	H	G	Kg	Package weight (Kg)
CM12-6-35	6	35	12	22	55	M5	0.2	0.2
CM12-6-80	6	80	12	67	100	M5	0.2	0.3
CM12-8-35	8	35	14	22	55	M5	0.2	0.2
CM12-8-55	8	55	14	42	75	M5	0.2	0.2
CM12-8-80	8	80	14	67	100	M5	0.3	0.3
CM12-10-35	10	35	16	22	45	M8	0.2	0.2
CM12-10-55	10	55	16	42	45	M8	0.2	0.3
CM12-10-80	10	80	16	67	45	M8	0.3	0.3
CM12-12-35	12	35	20	22	45	M8	0.2	0.2
CM12-12-55	12	55	20	42	45	M8	0.3	0.3
CM12-12-80	12	80	20	52	55	M8	0.3	0.4

C Internal coolant system installed.

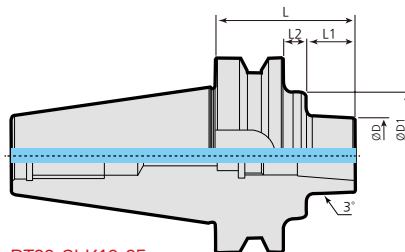


BT-SLK 2PIECES TYPE

Shrinking chuck



MAS 403-BT G2.5 5 μ m C
 Shank G value Run-out Coolant System



- ※ Dedicated PULL STUD bolts are necessary for BT30-SLK12-35.
- ※ The conventional order receiving to be converted after the current stock runs out.

	Model No.	ØD	L	ØD1	L1	L2	Kg	Package weight (Kg)
BT30	BT30-SLK12-35	38	35	-	13	-	0.4	0.5
	BT40-SLK12-45F	41	45	-	18	-	1.0	1.2
BT40	BT40-SLK12-75F	41	75	-	48	-	1.3	1.5
	BT40-SLK12-135F	41	135	-	108	-	2.1	2.4
BT50	BT50-SLK12-75	38	75	65	25	12	4.1	4.4
	BT50-SLK12-75F	41	75	65	25	12	4.1	4.4
	BT50-SLK12-105F	41	105	65	55	12	4.5	4.8
	BT50-SLK12-135F	41	135	65	85	12	5.3	5.7
	BT50-SLK12-225	38	225	65	150	37	6.2	6.6
	BT50-SLK12-315	38	315	90	150	127	11.5	11.9

C Internal coolant system installed.



DSC SPARE PART

Shrinking chuck related parts

Main components

Adjustment screw_length adjustment screw



※ Slim type untightening

Main components										
Type	DSC6	DSC8	DSC10	DSC12	DSC14	DSC16	DSC18	DSC20	DSC25	DSC32
Adjust screw	M520C		M820C			M1230C				

※ M820C screws are used for SK40-DSC6M-95.



NPM

New power milling chuck



Features

- Strong clamping force more than 500kgf*m (based on NPM42)
- Uses its DUST BLOCK function to prevent outside foreign substance completely
- Enables jet coolant operation
- Implements high precision within 15µm in the case of L/D=3
- Boring range : Ø20~Ø42

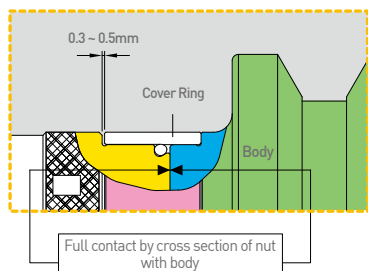
NAMING	BT40	—	NPM	—	32	—	110
	Spindle		New Power Milling Chuck		Tool Dia.		Length



Strong clamping force

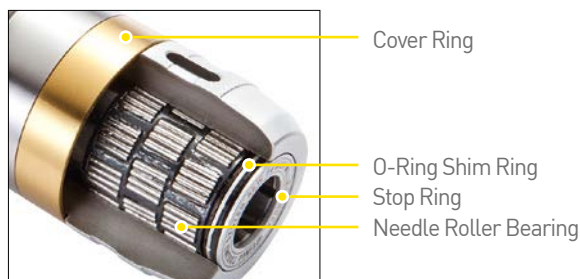
- NPM20 : Min. 130kgf-m
- NPM25 : Min. 265kgf-m
- NPM32 : Min. 350kgf-m
- NPM42 : Min. 500kgf-m
- NPM32(Short type) : Min. 230kgf-m

Durability enhanced by preventing foreign objects to be mixed (Dust Block) PAT.

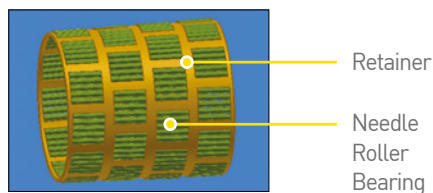


STOP RING applied to the front part
- Preventing mixing of SHIM RING and O-Ring

NPM Structural Features



Needle Roller Bearing (NPM20)



- Special steel bearing used to prevent damage
- Strong tightening due to load dispersion in the process of chucking

Enables stable machining from rough to medium boring

Ensures excellent vibration absorption and enhanced cutting power when cutting due to perfect cross-sectional adhesion and strong clamping force



Radial cutting depth (Rd)=1.0mm



Radial cutting depth (Rd)=2.5mm



Radial cutting depth (Rd)=3.5mm



Radial cutting depth (Rd)=5.0mm



Radial cutting depth (Rd)=8.0mm

Enables stable operation from rough to medium machining



NPM

New power milling chuck



Type

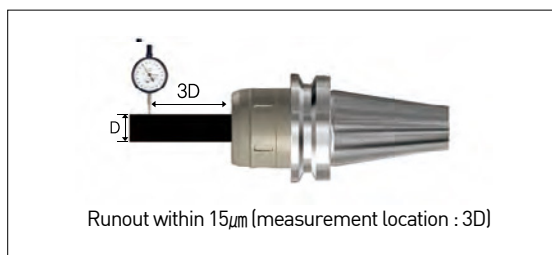
- **BT Type** : BT30, BT40, BT50
- **HSK Type** : HSK63A, HSK100A
- **SK Type** : SK30, SK40, SK50
- **NT Type** : NT40, NT50



BT Type HSK Type SK Type NT Type

High precision

- Run out accuracy within 15 μ m in the case of L/D=3
- Clamp inner diameter (Clamp I.D.) accuracy within 5 μ m



Internal coolant applicable



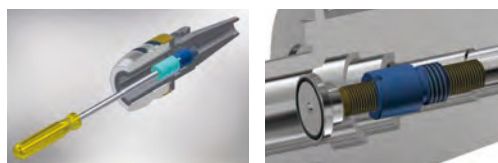
Internal refueling system



• **HSK shank is not available**

• **Add specifications of the CRS if not the basic application is adopted**

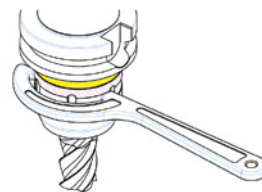
EX) CTC20-6 : Nut + Screw + CSR-6 (Change to the Coolant Stop Ring specifications wanting to use instead of a basic model)



SPEC	NUT	SCREW	COLANT STOP RING	Inner diameter (Ø)	Applicable shank	Remarks
CTC32(M16)-□□	CBN-M16N	CAS-M12	CSR-00	20, 25, 32	#30, 40, 50	#50 is not applicable to Inner diameter Ø32
CTC32(M24)-□□	CBN-M24N			32, 42	#50	

CAUTION

- Be sure not to use a spanner with a pipe, etc. inserted when tightening a milling chuck.
- Excessive clamping can deform and/or adversely affect a cutting tool.
- When tightening a cutting tool, be sure not to touch it with bare hands.
- When using a collet, push it all the way into the milling chuck.
- If the insertion depth of the collet is not normal, the tool such as an end mill, etc. may fall out and/or the milling chuck may be internally damaged.
- In case of NPM milling chuck failure, do not disassemble it arbitrarily
- In case of a problem arising out of arbitrary disassembly, remember that no adjustment will be provided.



Removable within an average of 2.5 turns



DCJ

Jetcoolant collet (for milling chuck)



Jet coolant Inside coolant

Features

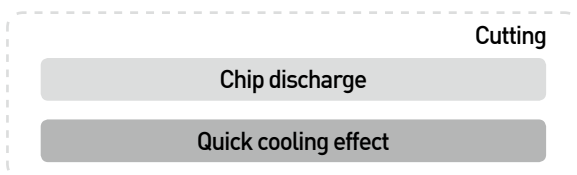
- Ensures a longer service life of cutting tools by preventing chips from adhering to tools
- Improves chip breakability/breaking strong jet injection
- Maintains the performance of the conventional milling chuck
- Enables a fast change of the inside jet coolant by collet replacement
- Available an ultrahigh-pressure inside coolant



Model No.	Ø6	Ø8	Ø10	Ø12	Ø16	Ø20	Ø25	Ø32
NPM20	●	●	●	●	●			
NPM32	●	●	●	●	●	●	●	
NPM42	●	●	●	●	●	●	●	●

※ Can be used for an ultrahigh-pressure inside coolant

NPM+JET COOLANT COLLET



Increased tool service life

Easy assembly



※ Can be used by only combining a collet with the conventional chuck (NPM)

COOLANT TYPE

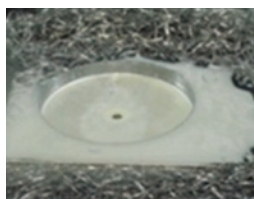
• Jet coolant



• Inside coolant



Chip evacuation



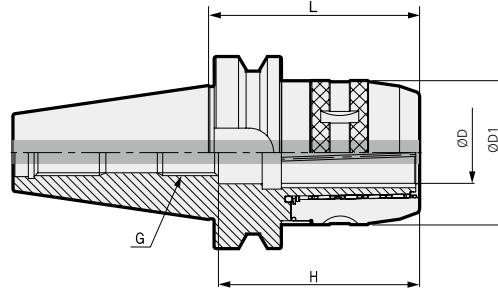
COOLANT TYPE

	Model No.
DCJ20	DCJ20-6
	DCJ20-8
	DCJ20-10
	DCJ20-12
	DCJ20-16
DCJ32	DCJ32-6
	DCJ32-8
	DCJ32-10
	DCJ32-12
	DCJ32-16
	DCJ32-20
	DCJ32-25



BT-NPM

New power milling chuck



- For more information on product features, see **52p**
- For more information on the related parts, see **61p**

• H : Depth of tool insertion

	Model No.	ØD	L	ØD1	H	G	COLLET	Kg	Package weight (kg)
BT30	BT30-NPM20-85	20	85	54	85	M16	DC20, DCS20, DCJ20	1.2	1.3
	BT40-NPM20-85	20	85	54	85	M16	DC20, DCS20, DCJ20	2.6	2.8
	BT40-NPM20-100	20	100	54	85	M16	DC20, DCS20, DCJ20	2.3	2.5
BT40	BT40-NPM25-85	25	85	61	85	M16	DC25	1.7	1.9
	BT40-NPM32-90	32	90	75	87	M16	DC32, DCS32, DCJ32	2.3	2.5
	BT40-NPM32-110	32	110	75	95	M16	DC32, DCS32, DCJ32	2.8	3.1
	BT40-NPM32-135	32	135	75	95	M16	DC32, DCS32, DCJ32	3.5	3.8
BT50	BT50-NPM20-95	20	95	54	85	M16	DC20, DCS20, DCJ20	4.3	4.6
	BT50-NPM20-125	20	125	54	85	M16	DC20, DCS20, DCJ20	4.7	5.1
	BT50-NPM20-165	20	165	54	85	M16	DC20, DCS20, DCJ20	5.2	5.6
	BT50-NPM32-110	32	110	75	105	M24	DC32, DCS32, DCJ32	5.0	5.3
	BT50-NPM32-135	32	135	75	105	M24	DC32, DCS32, DCJ32	5.7	6.1
	BT50-NPM32-165	32	165	75	105	M24	DC32, DCS32, DCJ32	6.9	7.3
	BT50-NPM42-110	42	110	90	125	M24	DC42, DCS42	5.4	5.7
	BT50-NPM42-135	42	135	90	125	M24	DC42, DCS42	6.5	6.9
	BT50-NPM42-165	42	165	90	125	M24	DC42, DCS42	7.9	8.3

Internal coolant system is optional.

※ In the case of $L \leq 90$, a short length cap is recommended while in the case of medium cutting, a longer product more than 90 is recommended.

Chuck

Arbor / Modular

Boring tool

Angular head

cBN/PCD

Smart factory

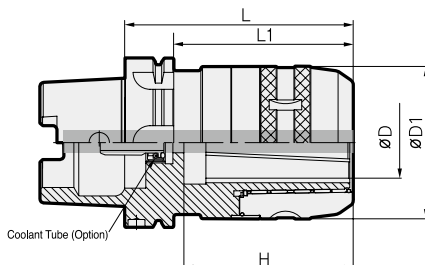
TAUMAX

OTHER



HSK-NPM

New power milling chuck



• **H** : Depth of tool insertion

- For more information on product features, see **52p**.
- For more information on the related parts, see **61p**.

	Model No.	ØD	L	ØD1	L1	H	COLLET	Kg	Package weight (Kg)
HSK63A	HSK63A-NPM20-100	20	100	54	74	75	DC20, DCS20, DCJ20	2.5	1.8
	HSK63A-NPM32-120	32	120	75	84	90	DC32, DCS32, DCJ32	2.9	2.8
	HSK100A-NPM32-130	32	130	75	101	90	DC32, DCS32, DCJ32	4.0	4.9
HSK100A									

C Internal coolant system is optional.

For separate purchase

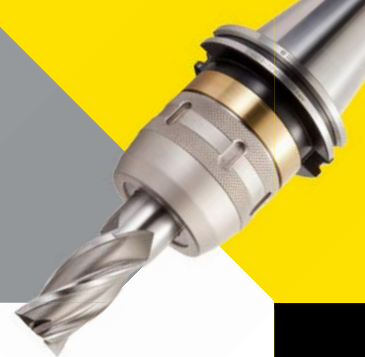


Classification by shank	
HSK50	HSK50A-CNS
HSK63	HSK63A-CNS
HSK100	HSK100A-CNS

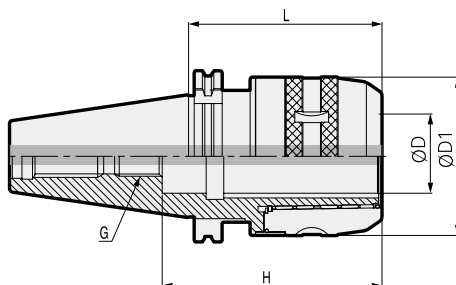


SK-NPM

New power milling chuck



DIN69871 -1A/B
15 μ m
130-500 kgf · m
C
Shank
Run-out
Clamping Force
Coolant System
Milling
Drilling



- For more information on product features, see **52p**
- For more information on the related parts, see **61p**

• **H** : Depth of tool insertion

	Model No.	ØD	L	ØD1	H	G	COLLET	Kg	Package weight (Kg)
SK40	SK40-NPM20-95	20	95	54	85	M16	DC20, DCS20, DCJ20	2.4	2.6
	SK40-NPM32-95	32	90	75	85	M16	DC32, DCS32, DCJ32	2.4	2.6
	SK40-NPM32-110	32	110	75	95	M16	DC32, DCS32, DCJ32	2.8	3.0
	SK40-NPM32-135	32	135	75	95	M16	DC32, DCS32, DCJ32	3.2	3.5
SK50	SK50-NPM20-100	20	100	54	85	M16	DC20, DCS20, DCJ20	3.6	3.9
	SK50-NPM32-100	32	100	75	105	M24	DC32, DCS32, DCJ32	4.3	4.6
	SK50-NPM32-130	32	130	75	105	M24	DC32, DCS32, DCJ32	5.2	5.6
	SK50-NPM42-110	42	110	90	125	M24	DC42, DCS42	5.2	5.5
	SK50-NPM42-135	42	135	90	125	M24	DC42, DCS42	6.1	6.5

C Internal coolant system is optional.

Chuck

Arbor / Modular

Boring tool

Angular head

cBN/PCD

Smart factory

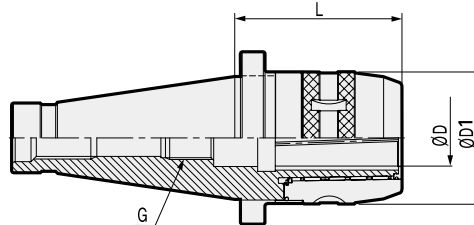
TAUMAX

OTHER



NT-NPM

New power milling chuck



- For more information on product features, see **52p**.
- For more information on the related parts, see **61p**.

	Model No.	ØD	L	ØD1	G	COLLET	Kg	Package weight (Kg)
NT40	NT40-NPM32-95	32	95	75	M16	DC32, DCS32, DCJ32	2.7	2.9
	NT50-NPM32-95	32	95	75	M24	DC32, DCS32, DCJ32	4.3	4.6
NT50	NT50-NPM42-95	42	95	90	M24	DC42, DCS42	4.8	5.1
	NT50M-NPM32-95	32	95	75	M24	DC32, DCS32, DCJ32	4.4	4.7
	NT50M-NPM42-95	42	95	90	M24	DC42, DCS42	4.9	5.2

C This product does not support the internal coolant system.

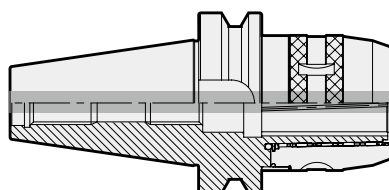


NPM SET

New power milling chuck SET



MAS 403-BT	15 μ m	130~500 kgf · m	C		
Shank	Run-out	Clamping Force	Coolant System	Milling	Drilling



- For more information on product features, see **52p**.
- HSK, SK/ B Set are customizable.

Images		Body	Collet	Spanner
BT40	Model No.			
	BT40-NPM32-110(A)	BT40-NPM32-110	DC32-6, 8, 10, 12, 16, 20, 25	75-79
	BT50-NPM32-110(A)	BT50-NPM32-110	DC32-6, 8, 10, 12, 16, 20, 25	75-79
BT50	BT50-NPM42-110(A)	BT50-NPM42-110	DC42-6, 8, 10, 12, 16, 20, 25, 32	92-96

Internal coolant system is optional.

※ B Set includes MT collet and DJT collet in addition to the above item list.



A Set

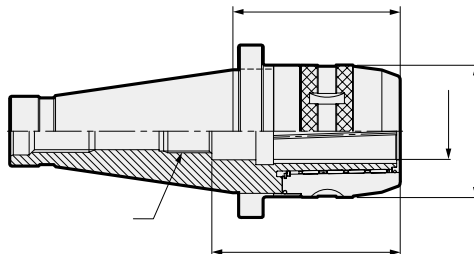


B Set

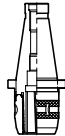
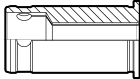





NT-NPM SET

New power milling chuck SET



• For more information on product features, see **52p**

	Images	Body	Collet	MT Collet	DJT	Spanner
	Model No.					
NT40	NT40-NPM32-95(B)	NT40-NPM32-95	DC32-6, 8, 10, 12, 16, 20, 25	TC32-MT1,2,3	DJT32-6	75-79
	NT50-NPM32-95(B)	NT50-NPM32-95	DC32-6, 8, 10, 12, 16, 20, 25	TC32-MT1,2,3	DJT32-6	75-79
NT50	NT50-NPM42-95(B)	NT50-NPM42-95	DC42-6, 8, 10, 12, 16, 20, 25, 32	TC42-MT1,2,3,4	DJT42-6	92-96

C This product does not support the internal coolant system.



NPM SPARE PART

New power milling chuck



For separate purchase (BT/SK)

Spare Part		For separate purchase		
Type	Coolant system (BT/SK)	Collet	Spanner	
Images				
	Model No.			
NPM20	CTC20-□□	DCS20, DC20, DCJ20	57-60	
NPM32	CTC32-□□	DCS32, DC32, DCJ32	75-79	
NPM42	CTC42-□□	DCS42, DC42	92-96	

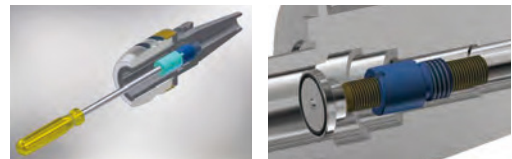
For separate purchase (HSK)

Spare Part		For separate purchase	
		Coolant tube	
Classification by shank			
HSK50		HSK50A-CNS	
HSK63		HSK63A-CNS	
HSK100		HSK100A-CNS	

Internal refueling system

- HSK shank is not available
- Add specifications of the CRS if not the basic application is adopted

EX) CTC20-6 : Nut + Screw + CSR-6 (Change to the Coolant Stop Ring specifications wanting to use instead of a basic model)



SPEC	NUT	SCREW	COLANT STOP RING	Inner diameter (Ø)	Applicable shank	Remarks
CTC32(M16)-□□	CBN-M16N	CAS-M12	CSR-00	20, 25, 32	#30, 40, 50	#50 is not applicable to Inner diameter Ø32
CTC32(M24)-□□	CBN-M24N			32, 42	#50	



DCL NEW

Lock collet for milling chuck



Features

Milling chuck equipped with anti-fallout feature to prevent poor milling when machining a workpiece and improve tool service life (with DINE's milling chuck)

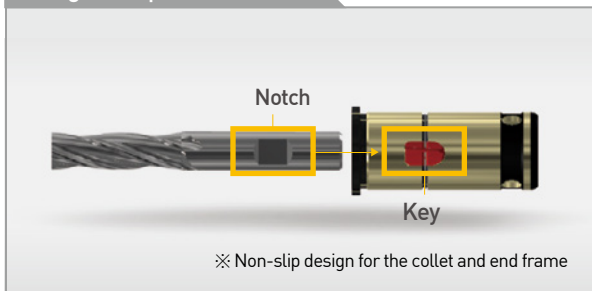
- Prevents the tool from falling out due to coolant pressure and vibration
- Useful for working with difficult-to-cut materials that require high workload
- Fit for difficult-to-cut materials with ultralight weight and high hardness in aerospace and automobile industries



NAMING	DCL	32	20
	DINE Lock-Collet	Collet Size	Tool Dia.

Structural Features

Designed to prevent fallout

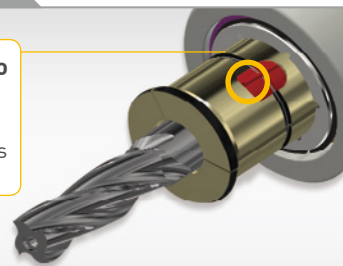


- Designed especially for extreme machining with a lot of mechanical actions, prevents the tool from deviating or falling out.
- Weldon flat (DINE 6535HB) end mill used

Designed as non-slip

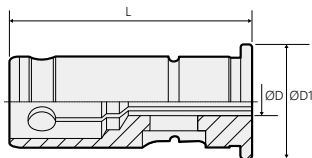
Inserting the key to the body slotting

Designed to be assembled regardless of 6 places of slotting



- Closely adhered to the grooves of the milling chuck - No slip occurring even under high torque

Detailed Specifications



	Model No.	ØD	ØD1	L
DCL20	DCL20-6	6	20	53
	DCL20-8	8	20	53
	DCL20-10	10	20	53
	DCL20-12	12	20	53
	DCL20-14	14	20	53
	DCL20-16	16	20	53
DCL32	DCL32-6	6	32	64.5
	DCL32-8	8	32	64.5
	DCL32-10	10	32	64.5
	DCL32-12	12	32	64.5
	DCL32-14	14	32	64.5
	DCL32-16	16	32	64.5
	DCL32-18	18	32	64.5
	DCL32-20	20	32	64.5
	DCL32-25	25	32	64.5

※ DIN 6535 specifications end mill used





DCL SPARE PART

Non-slip milling chuck collet related parts



SPARE PART

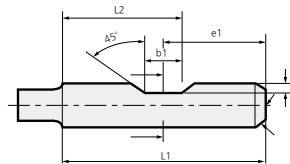
TYPE	Main component	
	Key	C-Grip
		
DCL20-6	DCL20-6K	DCL-CG20
DCL20-8	DCL20-8K	DCL-CG20
DCL20-10	DCL20-10K	DCL-CG20
DCL20-12	DCL20-12K	DCL-CG20
DCL20-14	DCL20-14K	DCL-CG20
DCL20-16	DCL20-16K	DCL-CG20
DCL32-6	DCL32-6K	DCL-CG32
DCL32-8	DCL32-8K	DCL-CG32
DCL32-10	DCL32-10K	DCL-CG32
DCL32-12	DCL32-12K	DCL-CG32
DCL32-14	DCL32-14K	DCL-CG32
DCL32-16	DCL32-16K	DCL-CG32
DCL32-18	DCL32-18K	DCL-CG32
DCL32-20	DCL32-20K	DCL-CG32
DCL32-25	DCL32-25K	DCL-CG32



Notched Endmill

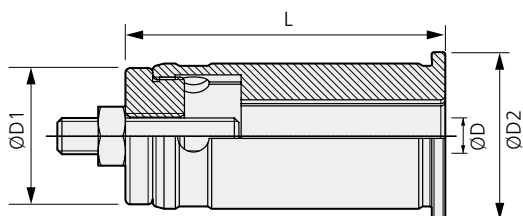
Notched Endmill

Detailed Specifications



Tool Ø	Tool [DIN6535]				
	L1	e1	b1	L2	t
6	36	18	4.2	20.1	0.9
8	36	18	5.5	20.75	1.1
10	40	20	7	23.5	1.5
12	45	22.5	8	26.5	1.6
14	45	22.5	8	26.5	1.3
16	48	24	10	29	1.8
18	48	24	10	29	1.8
20	50	25	11	30.5	1.8
25	56	32	12	30	2
32	60	36	14	31	2

※ DIN 6535 specifications end mill used ※ As a separate purchase, it can be referred to when using ERL/L collet.



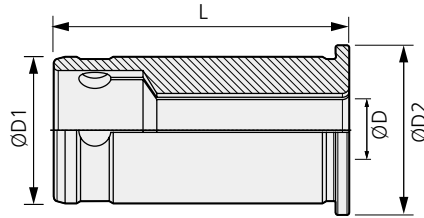
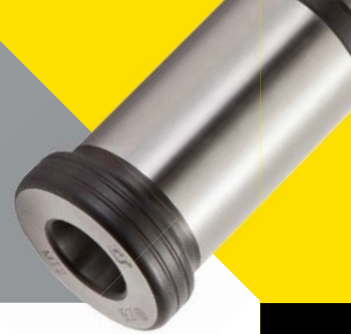
• It can be adjusted in length with a collet adjustment screw.

	Model No.	ØD	L	ØD1	ØD2	Kg	Package weight (Kg)
DCS20	DCS20-6	6	57	20	25	0.1	0.1
	DCS20-8	8	57	20	25	0.1	
	DCS20-10	10	57	20	25	0.1	
	DCS20-12	12	57	20	25	0.1	
	DCS20-16	16	57	20	25	0.1	
DCS32	DCS32-6	6	70.5	32	37	0.2	0.2~0.3
	DCS32-8	8	70.5	32	37	0.2	
	DCS32-10	10	70.5	32	37	0.2	
	DCS32-12	12	70.5	32	37	0.2	
	DCS32-14	14	70.5	32	37	0.2	
	DCS32-16	16	70.5	32	37	0.2	
	DCS32-19	19	70.5	32	37	0.2	
	DCS32-20	20	70.5	32	37	0.2	
	DCS32-25	25	70.5	32	37	0.2	
	DCS42	DCS42-6	6	80	42	47	
DCS42-8		8	80	42	47	0.5	
DCS42-10		10	80	42	47	0.5	
DCS42-12		12	80	42	47	0.5	
DCS42-16		16	80	42	47	0.5	
DCS42-20		20	80	42	47	0.5	
DCS42-25		25	80	42	47	0.5	
DCS42-32		32	80	42	47	0.5	



DC

Straight collet



	Model No.	ØD	L	ØD1	ØD2	Kg	Package weight (Kg)
DC20	DC20-6	6	53	20	25	0.1	0.1
	DC20-8	8	53	20	25	0.1	
	DC20-10	10	53	20	25	0.1	
	DC20-12	12	53	20	25	0.1	
	DC20-14	14	53	20	25	0.1	
	DC20-16	16	53	20	25	0.1	
DC25	DC25-6	6	61.5	25	29	0.2	0.2
	DC25-8	8	61.5	25	29	0.2	
	DC25-10	10	61.5	25	29	0.2	
	DC25-12	12	61.5	25	29	0.2	
	DC25-16	16	61.5	25	29	0.2	
DC32	DC32-6	6	64.5	32	37	0.2	0.3
	DC32-8	8	64.5	32	37	0.2	
	DC32-10	10	64.5	32	37	0.2	
	DC32-12	12	64.5	32	37	0.2	
	DC32-14	14	64.5	32	37	0.2	
	DC32-16	16	64.5	32	37	0.2	
	DC32-19	19	64.5	32	37	0.2	
	DC32-20	20	64.5	32	37	0.2	
	DC32-25	25	64.5	32	37	0.2	
DC42	DC42-6	6	73	42	47	0.5	0.3-0.5
	DC42-8	8	73	42	47	0.5	
	DC42-10	10	73	42	47	0.5	
	DC42-12	12	73	42	47	0.5	
	DC42-16	16	73	42	47	0.5	
	DC42-20	20	73	42	47	0.5	
	DC42-25	25	73	42	47	0.5	
	DC42-32	32	73	42	47	0.5	

Chuck

Arbor / Modular

Boring tool

Angular head

cBN/PCD

Smart factory

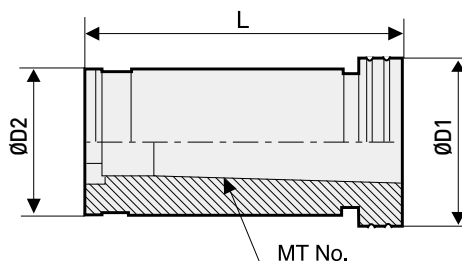
TAUMAX

OTHER



TC

Taper collet

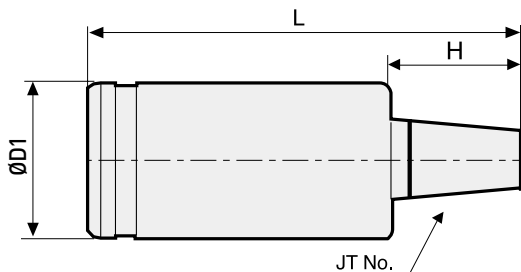


	Model No.	MT No.	L	ØD1	ØD2	Kg	Package weight (kg)
TC20	TC20-1	MT1	60	20	26	0.1	0.1
	TC20-2	MT2	72	20	26	0.1	0.1
TC25	TC25-1	MT1	60	25	32	0.2	0.2
	TC25-2	MT2	72	25	32	0.2	0.2
TC32	TC32-1	MT1	60	32	38	0.4	0.4
	TC32-2	MT2	72	32	38	0.4	0.4
	TC32-3	MT3	90	32	38	0.4	0.4
TC42	TC42-1	MT1	60	42	48	0.6	0.6
	TC42-2	MT2	72	42	48	0.7	0.7
	TC42-3	MT3	90	42	48	0.8	0.8
	TC42-4	MT4	112.5	42	48	0.9	0.9



DJT

Drill chuck arbor



DJT20, DJT32, DJT42

Model No.	JT No.	L	ØD1	H	Kg	Package weight (kg)
DJT20-6	JT6	83	20	28	0.2	0.2
DJT32-6	JT6	93	32	28	0.5	0.5
DJT42-6	JT6	103	42	28	0.9	0.9

Chuck

Arbor / Modular

Boring tool

Angular head

cBN/PCD

Smart factory

TAUMAX

OTHER



SDC/P

Precision collet chuck for multi purpose machining



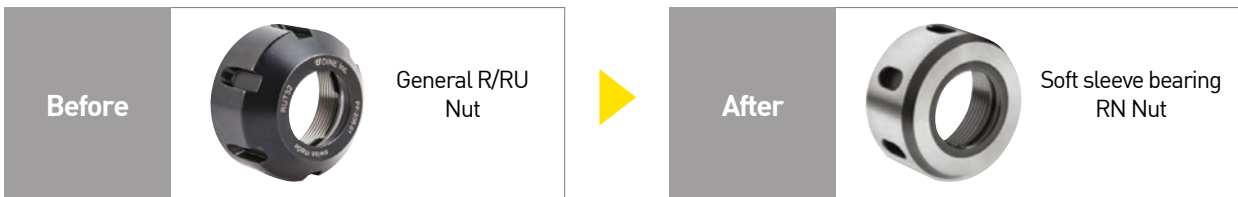
Features

- Improved precision (higher than conventional SDC)
- Simpler model number management than conventional SDC due to its organized gauge line
- Collet chuck suitable for multi-purpose machining with SWISS-MADE sleeve nut adopted
- Boring range : $\varnothing 1\text{--}\varnothing 25$

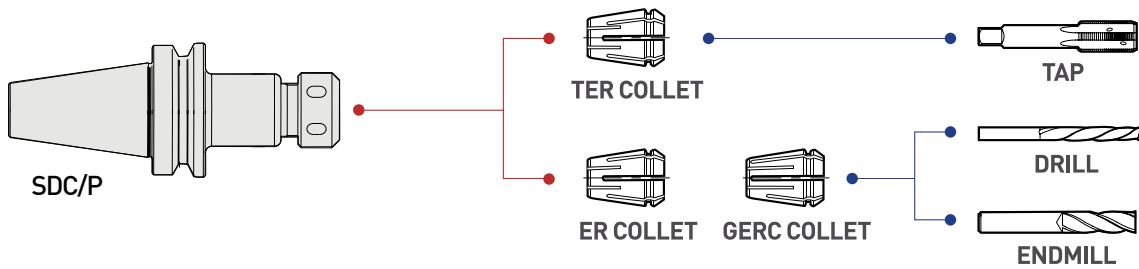
NAMING	BT30	–	SDC	10	P	–	100
	Spindle		Collet chuck	Tool Dia.	Precision		Length



Best functional Nut(SWISS made)



SDC/P Application



SPARE PART

Main components

Chuck	Main components	
	Sleeve bearing nut	Adjust screw
TYPE		
SDC 7P	RN11	BN0716F
SDC 10P	RN16	BN1025F
SDC 13P	RN20	BN1325F
SDC 16P	RN25	BN1830F
SDC 20P	RN32	BN2230F
SDC 26P	RN40	BN2838F

For separate purchase

Chuck	For separate purchase	
	Spanner	Collet
TYPE		
SDC 7P	20-22	GERC/ER 11-ØD
SDC 10P	32-35	GERC/ER 16-ØD
SDC 13P	35-38	GERC/ER 20-ØD
SDC 16P	42-46	GERC/ER 25-ØD
SDC 20P	48-52	GERC/ER 32-ØD
SDC 26P	62-65	GERC/ER 40-ØD



BT-SDC/P

Precision collet chuck for multi purpose machining



Fig.1

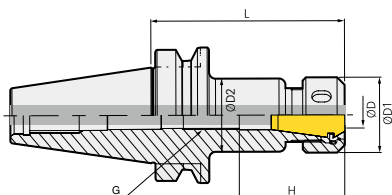


Fig.2

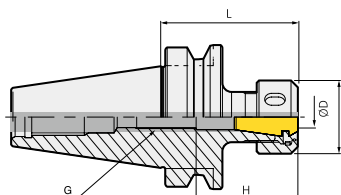
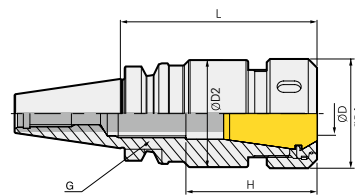


Fig.3



• H : Depth of tool insertion

※ Using oil hole types requires the standard dimension.

• For more information on the product features, see **68p**

• For more information on the related parts, see **72p**

• For more information on the applicable collet, see **75p**

	Model No.	ØD	L	ØD1	ØD2	H	COLLET	G	Fig.	Kg	Package weight (Kg)
BT30	BT30-SDC7P-70	1.0~7.0	70	18	17	33	GERC11	M7	1	0.5	0.5
	BT30-SDC7P-100	1.0~7.0	100	18	17	33	GERC11	M7	1	0.5	0.6
	BT30-SDC10P-50	1.0~10.0	50	32	-	44.5	GERC16	M10	2	0.5	0.6
	BT30-SDC10P-70	1.0~10.0	70	32	31	44.5	GERC16	M10	1	0.6	0.6
	BT30-SDC10P-100	1.0~10.0	100	32	31	44.5	GERC16	M10	1	0.7	0.9
	BT30-SDC13P-50	1.0~13.0	50	35	-	49	GERC20	M13	2	0.5	0.6
	BT30-SDC13P-70	1.0~13.0	70	35	34	49	GERC20	M13	1	0.6	0.7
	BT30-SDC13P-100	1.0~13.0	100	35	34	49	GERC20	M13	1	0.8	0.9
	BT30-SDC16P-50	2.0~16.0	50	42	-	50	GERC25	M18	2	0.5	0.6
	BT30-SDC16P-70	2.0~16.0	70	42	41	50	GERC25	M18	1	0.7	0.8
	BT30-SDC16P-100	2.0~16.0	100	42	41	50	GERC25	M18	1	1.0	1.1
	BT30-SDC20P-60	2.0~20.0	60	50	-	60	GERC32	M22	2	0.6	0.7
BT30-SDC20P-90	2.0~20.0	90	50	49	60	GERC32	M22	3	1.0	1.1	
BT30-SDC20P-120	2.0~20.0	120	50	49	60	GERC32	M22	3	1.4	1.5	
BT40	BT40-SDC7P-70	1.0~7.0	70	18	17	33	GERC11	M7	1	0.9	1.1
	BT40-SDC7P-90	1.0~7.0	90	18	17	33	GERC11	M7	1	0.9	1.2
	BT40-SDC7P-130	1.0~7.0	130	18	17	33	GERC11	M7	1	1.0	1.2
	BT40-SDC10P-70	1.0~10.0	70	32	31	44.5	GERC16	M10	1	1.0	1.2
	BT40-SDC10P-90	1.0~10.0	90	32	31	44.5	GERC16	M10	1	1.2	1.4
	BT40-SDC10P-130	1.0~10.0	130	32	31	44.5	GERC16	M10	2	1.4	1.5
	BT40-SDC13P-70	1.0~13.0	70	35	34	49	GERC20	M13	1	1.1	1.2
	BT40-SDC13P-90	1.0~13.0	90	35	34	49	GERC20	M13	1	1.2	1.4
	BT40-SDC13P-130	1.0~13.0	130	35	34	49	GERC20	M13	1	1.4	1.6
	BT40-SDC13P-150	1.0~13.0	150	35	34	49	GERC20	M13	1	1.6	1.8
	BT40-SDC16P-70	2.0~16.0	70	42	41	50	GERC25	M18	1	1.1	1.3
	BT40-SDC16P-90	2.0~16.0	90	42	41	50	GERC25	M18	1	1.3	1.5
	BT40-SDC16P-130	2.0~16.0	130	42	41	50	GERC25	M18	1	1.7	1.9
	BT40-SDC20P-70	2.0~20.0	70	50	-	60	GERC32	M22	2	1.1	1.3
	BT40-SDC20P-90	2.0~20.0	90	50	49	60	GERC32	M22	1	1.4	1.6
	BT40-SDC20P-130	2.0~20.0	130	50	49	60	GERC32	M22	1	1.9	2.2
	BT40-SDC20P-150	2.0~20.0	150	50	49	60	GERC32	M22	1	2.2	2.5
	BT40-SDC26P-90	16.0~25.0	90	63	62	71	GERC40	M28	1	1.7	1.9

☐ Internal coolant system is optional.



BT-SDC/P

Precision collet chuck for multi purpose machining



Fig.1

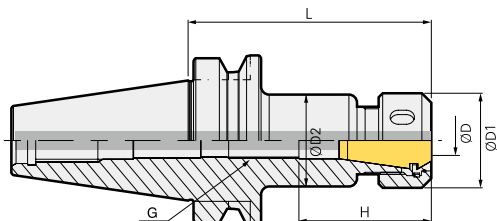
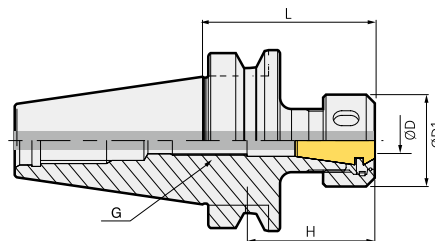


Fig.2



• **H** : Depth of tool insertion

※ Using oil hole types requires the standard dimension.

• For more information on the product features, see **68p**.

• For more information on the related parts, see **72p**.

• For more information on the applicable collet, see **75p**.

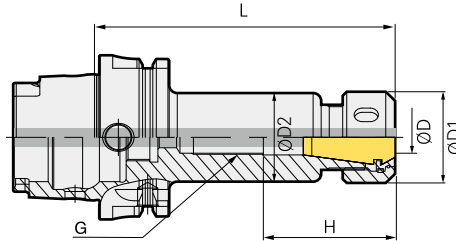
Model No.	ØD	L	ØD1	ØD2	H	COLLET	G	Fig.	Kg	Package weight (Kg)
BT50-SDC10P-100	1.0~10.0	100	32	31	44.5	GERC16	M10	1	3.7	4.0
BT50-SDC10P-120	1.0~10.0	120	32	31	44.5	GERC16	M10	1	3.7	4.1
BT50-SDC10P-160	1.0~10.0	160	32	31	44.5	GERC16	M10	1	3.8	4.4
BT50-SDC13P-100	1.0~13.0	100	35	34	49	GERC20	M13	1	3.8	4.1
BT50-SDC13P-130	1.0~13.0	130	35	34	49	GERC20	M13	1	3.8	4.2
BT50-SDC13P-160	1.0~13.0	160	35	34	49	GERC20	M13	1	4.1	4.5
BT50-SDC13P-180	1.0~13.0	180	35	34	49	GERC20	M13	1	4.2	4.6
BT50-SDC16P-100	2.0~16.0	100	42	41	50	GERC25	M18	1	3.9	4.2
BT50-SDC16P-160	2.0~16.0	160	42	41	50	GERC25	M18	1	4.3	4.7
BT50-SDC20P-70	2.0~20.0	70	50	-	60	GERC32	M22	2	1.7	2.0
BT50-SDC20P-100	2.0~20.0	100	50	49	60	GERC32	M22	1	4.0	4.3
BT50-SDC20P-130	2.0~20.0	130	50	49	60	GERC32	M22	1	4.3	4.7
BT50-SDC20P-160	2.0~20.0	160	50	49	60	GERC32	M22	1	4.7	5.1
BT50-SDC20P-180	2.0~20.0	180	50	49	60	GERC32	M22	1	5.0	5.4
BT50-SDC26P-160	16.0~26.0	160	63	62	71	GERC40	M28	1	5.5	5.9

☐ Internal coolant system is optional.



HSK-SDC/P

Precision collet chuck for multi purpose machining



• **H** : Depth of tool insertion

※ Using oil hole types requires the standard dimension.

• For more information on the product features, see **68p**

• For more information on the related parts, see **72p**

• For more information on the applicable collet, see **75p**

	Model No.	ØD	L	ØD1	ØD2	H	G	COLLET	Kg	Package weight (Kg)
HSK63A	HSK63A-SDC10P-100	1.0~10.0	100	32	31	44.5	M10	GERC16	1.0	1.1
	HSK63A-SDC13P-100	1.0~13.0	100	35	34	49	M7	GERC20	1.1	1.2
	HSK63A-SDC16P-100	2.0~16.0	100	42	41	50	M7	GERC25	1.2	1.4
	HSK63A-SDC20P-110	2.0~20.0	110	50	49	60	M7	GERC32	1.5	1.7
HSK100A	HSK100A-SDC16P-110	2.0~16.0	110	42	41	50	M13	GERC25	2.6	2.9
	HSK100A-SDC20P-120	2.0~20.0	120	50	49	60	M10	GERC32	2.9	3.3

☐ Internal coolant system is optional.

For separate purchase



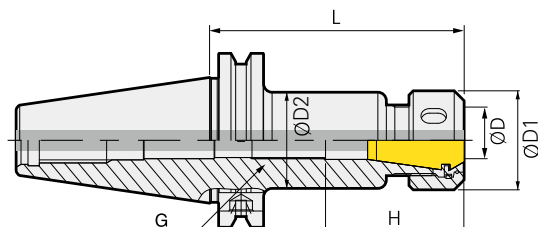
Internal coolant system

Classification by shank	
HSK50	HSK50A-CNS
HSK63	HSK63A-CNS
HSK100	HSK100A-CNS



SK-SDC/P

Precision collet chuck for multi purpose machining



- **H** : Depth of tool insertion
 - For more information on the product features, see **68p**.
 - For more information on the related parts, see **72p**.
 - For more information on the applicable collet, see **75p**.
- ※ Using oil hole types requires the standard dimension.

	Model No.	ØD	L	ØD1	ØD2	H	COLLET	G	Kg	Package weight (Kg)
SK40	SK40-SDC10P-90	1.0~10.0	90	32	31	44.5	GERC16	M10	1.1	1.2
	SK40-SDC13P-90	1.0~13.0	90	35	34	49	GERC20	M13	1.2	1.3
	SK40-SDC13P-120	1.0~13.0	120	35	34	49	GERC20	M13	1.3	1.5
	SK40-SDC16P-90	2.0~16.0	90	42	41	50	GERC25	M18	1.4	1.5
	SK40-SDC20P-90	2.0~20.0	90	50	49	60	GERC32	M13	1.5	1.6

☐ Internal coolant system is optional.



SDC/P SPARE PART

ER collet chuck related parts

Spare Part		
Main components		
Type	Sleeve bearing nut	Adjust screw
Images		
Model No.		
SDC 7P	RN11	BN0716F
SDC 10P	RN16	BN1025F
SDC 13P	RN20	BN1325F
SDC 16P	RN25	BN1830F
SDC 20P	RN32	BN2230F
SDC 26P	RN40	BN2838F

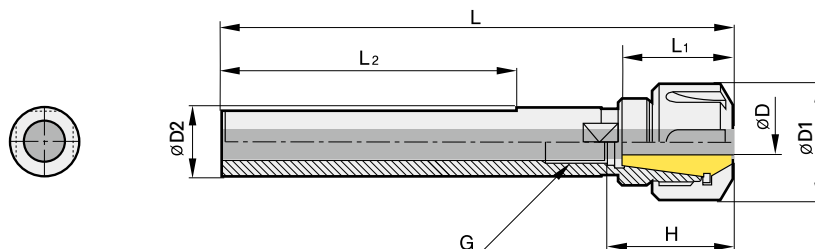
Spare Part		
For separate purchase		
Type	Spanner	GERC / ER
Images		
Model No.		
SDC 7P	20-22	GERC/ER 11-ØD
SDC 10P	32-35	GERC/ER 16-ØD
SDC 13P	35-38	GERC/ER 20-ØD
SDC 16P	42-46	GERC/ER 25-ØD
SDC 20P	48-52	GERC/ER 32-ØD
SDC 26P	62-65	GERC/ER 40-ØD

※ BN0716F screws are used for BT30-SDC13P-50/HSK63A-SDC13P-100.



S-SDC

Straight shank collet chuck



• For more information on the applicable collet, see **75p**

	Model No.	ØD	L	ØD1	ØD2	L1	L2	H	COLLET	G	Kg	Package weight (Kg)
S16, S20	S16-SDC7-120M	1.0~7.0	120	19	16	-	73	33	GERC11	M7	0.1	0.2
	S16-SDC7-120T	1.0~7.0	120	19	16	-	73	33	GERC11	M7	0.1	0.2
	S16-SDC10-150T	1.0~10.0	150	28	16	46.5	83	34.5	GERC16	M10	0.2	0.3
	S20-SDC10-150M	1.0~10.0	150	28	20	26.5	83	34.5	GERC16	M10	0.3	0.4
	S20-SDC10-150T	1.0~10.0	150	28	20	26.5	83	34.5	GERC16	M10	0.3	0.4
	S20-SDC13-150M	1.0~13.0	150	35	20	50	83	49	GERC20	M13	0.3	0.4
	S20-SDC13-150T	1.0~13.0	150	35	20	50	83	49	GERC20	M13	0.3	0.4
S25, S32	S25-SDC10-150M	1.0~10.0	150	28	25	-	83	34.5	GERC16	M10	0.4	0.5
	S25-SDC10-150T	1.0~10.0	150	28	25	-	83	34.5	GERC16	M10	0.4	0.5
	S25-SDC13-150M	1.0~13.0	150	35	25	-	83	49	GERC20	M13	0.4	0.5
	S25-SDC13-150T	1.0~13.0	150	35	25	-	83	49	GERC20	M13	0.4	0.5
	S32-SDC13-150M	1.0~13.0	150	35	32	-	83	49	GERC20	M13	0.7	0.8
	S32-SDC13-150T	1.0~13.0	150	35	32	-	83	49	GERC20	M13	0.7	0.8
	S32-SDC20-165M	2.0~20.0	165	50	32	-	83	60	GERC32	M22	0.9	1.0
S32-SDC20-165T	2.0~20.0	165	50	32	-	83	60	GERC32	M22	0.9	1.0	

☐ Internal coolant system is optional.

※ For milling (M)/ for lathe operation (T) - e.g.) S16-SDC7-120M (for milling) / S16-SDC7-120T (for lathe operation)

※ Can be used by being tightened with a milling chuck.

Chuck

Arbor / Modular

Boring tool

Angular head

cBN/PCD

Smart factory

TAUMAX

OTHER



S-SDC/S

Straight shank collet chuck slim type



Fig.1

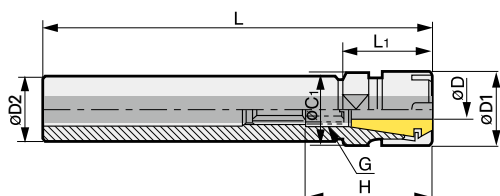
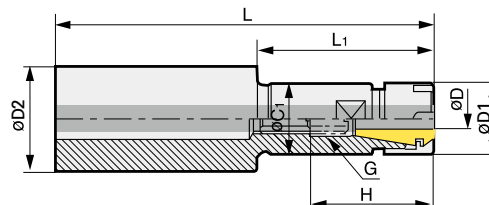


Fig.2



• H : Depth of tool insertion

• For more information on the applicable collet, see **75p**.

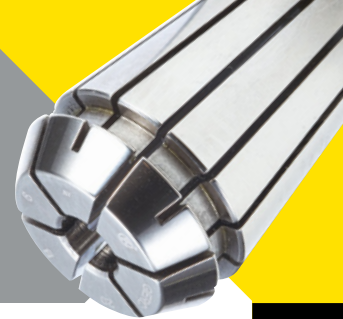
	Model No.	ØD	L	ØD1	ØD2	L1	H	Collet/step	G	Kg	Package weight (Kg)
S16, S20	S16-SDC7S-100M	1.0~7.0	100	16	16	21	33	GERC11/0.5	M7	0.1	0.2
	S16-SDC7S-150M	1.0~7.0	150	16	16	21	33	GERC11/0.5	M7	0.1	0.2
	S16-SDC10S-100M	1.0~10.0	100	22	16	50	44.5	GERC16/1.0	M10	0.1	0.2
	S16-SDC10S-150M	1.0~10.0	150	22	16	50	44.5	GERC16/1.0	M10	0.1	0.2
	S20-SDC7S-100M	1.0~7.0	100	16	20	30	35	GERC11/0.5	M7	0.1	0.2
	S20-SDC7S-150M	1.0~7.0	150	16	20	80	35	GERC11/0.5	M7	0.2	0.3
	S20-SDC10S-100M	1.0~10.0	100	22	20	50	44.5	GERC16/1.0	M10	0.1	0.2
	S20-SDC10S-150M	1.0~10.0	150	22	20	50	44.5	GERC16/1.0	M10	0.2	0.3
	S20-SDC10S-200M	1.0~10.0	200	22	20	50	44.5	GERC16/1.0	M10	0.3	0.4
	S20-SDC13S-100M	1.0~13.0	100	28	20	50	49	GERC20/1.0	M13	0.1	0.2
S20-SDC13S-150M	1.0~13.0	150	28	20	50	49	GERC20/1.0	M13	0.2	0.3	
S25, S32	S25-SDC7S-100M	1.0~7.0	100	16	25	30	33	GERC11/0.5	M7	0.2	0.3
	S25-SDC7S-150M	1.0~7.0	150	16	25	80	33	GERC11/0.5	M7	0.2	0.3
	S25-SDC10S-100M	1.0~10.0	100	22	25	30	44.5	GERC16/1.0	M10	0.2	0.3
	S25-SDC10S-150M	1.0~10.0	150	22	25	80	44.5	GERC16/1.0	M10	0.3	0.4
	S25-SDC13S-100M	1.0~13.0	100	28	25	50	49	GERC20/1.0	M13	0.2	0.3
	S25-SDC13S-150M	1.0~13.0	150	28	25	50	49	GERC20/1.0	M13	0.4	0.5
	S25-SDC16S-100M	1.0~16.0	100	35	25	50	50	GERC25/1.0	M18	0.3	0.4
	S25-SDC16S-150M	1.0~16.0	150	35	25	50	50	GERC25/1.0	M18	0.4	0.5
	S25-SDC16S-200M	1.0~16.0	200	35	25	50	50	GERC25/1.0	M18	0.6	0.7
	S32-SDC16S-120M	1.0~16.0	120	35	32	50	50	GERC25/1.0	M18	0.5	0.6
S32-SDC16S-150M	1.0~16.0	150	35	32	50	50	GERC25/1.0	M18	0.6	0.7	

C Internal coolant system is optional.



GERC

GERC Collet



General 5 μ m	Precision 2 μ m	Waterproof	Coolant System
Run-out	Run-out		

Features

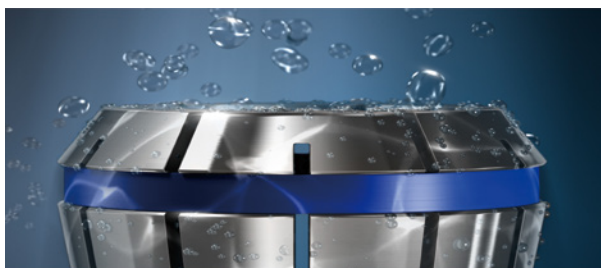
- Collet that prevents surface corrosion to micro range
- Maintains functionality and precision for a long time based on advanced coating technology
- Economic use for tool life

NAMING	GERC	16	—	4	HP
	GERC Collet	Collet Size		Tool Dia.	HP : Precision NON : General



Special coating technology

The characteristics of the conventional unprotected collet unlike GERC collets are as follows:
The conventional uncoated collet is affected by corrosion in a short time due to various causes such as humidity, cutting oil, detergent, salt, and gas. This affects not only the collet but also the entire machining process.



A rusty collet shortens tool service life and greatly lowers precision. To avoid this situation, surface coating is performed to micro range to effectively protect a collet and maintain its precision for a long time by preventing it from corroding in the long term.



Two collets used for 4 months :

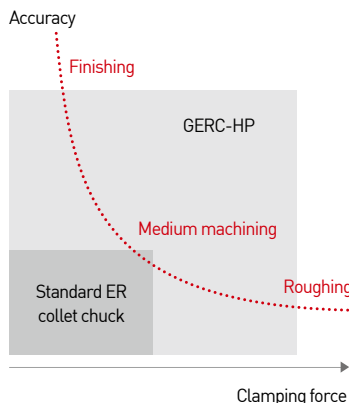
The left one is an uncoated collet, and the right one is a GERC-used collet.

GERC-HP (precision type)

The precision type collet chuck is more expensive than the general collect chuck but in terms of long-term cost efficiency, its benefits are far greater. Its maximum accuracy provides more excellent workpieces due to its less manufacturing tolerance, minimizing costly re-work.

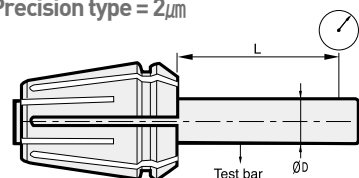


Precision type 2 μ m



Accuracy (L/D=3)

General type = 5 μ m
Precision type = 2 μ m



Chuck

Arbor / Modular

Boring tool

Angular head

cBN/PCD

Smart factory

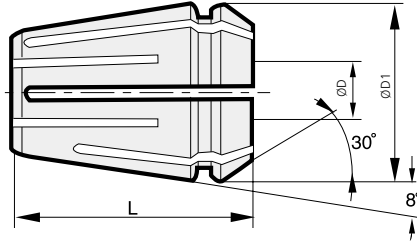
TAUMAX

OTHER



GERC COLLET

GERC collet (general type)



	Model No.	ER Size	ØD	L	ØD1	Accuracy
GERC11	GERC11-1.0	11	1.0	18.0	11.5	5µm
	GERC11-1.5	11	1.5	18.0	11.5	5µm
	GERC11-2.0	11	2.0	18.0	11.5	5µm
	GERC11-2.5	11	2.5	18.0	11.5	5µm
	GERC11-3.0	11	3.0	18.0	11.5	5µm
	GERC11-3.5	11	3.5	18.0	11.5	5µm
	GERC11-4.0	11	4.0	18.0	11.5	5µm
	GERC11-4.5	11	4.5	18.0	11.5	5µm
	GERC11-5.0	11	5.0	18.0	11.5	5µm
	GERC11-5.5	11	5.5	18.0	11.5	5µm
GERC16	GERC16-1.0	16	1.0	27.5	17.0	5µm
	GERC16-2.0	16	2.0	27.5	17.0	5µm
	GERC16-3.0	16	3.0	27.5	17.0	5µm
	GERC16-4.0	16	4.0	27.5	17.0	5µm
	GERC16-4.5	16	4.5	27.5	17.0	5µm
	GERC16-5.0	16	5.0	27.5	17.0	5µm
	GERC16-6.0	16	6.0	27.5	17.0	5µm
	GERC16-7.0	16	7.0	27.5	17.0	5µm
	GERC16-8.0	16	8.0	27.5	17.0	5µm
	GERC16-9.0	16	9.0	27.5	17.0	5µm
GERC20	GERC20-1.0	20	1.0	31.5	21.0	5µm
	GERC20-2.0	20	2.0	31.5	21.0	5µm
	GERC20-3.0	20	3.0	31.5	21.0	5µm
	GERC20-4.0	20	4.0	31.5	21.0	5µm
	GERC20-5.0	20	5.0	31.5	21.0	5µm
	GERC20-6.0	20	6.0	31.5	21.0	5µm
	GERC20-7.0	20	7.0	31.5	21.0	5µm
	GERC20-8.0	20	8.0	31.5	21.0	5µm
	GERC20-9.0	20	9.0	31.5	21.0	5µm
	GERC20-10.0	20	10.0	31.5	21.0	5µm
	GERC20-11.0	20	11.0	31.5	21.0	5µm
	GERC20-12.0	20	12.0	31.5	21.0	5µm
	GERC20-13.0	20	13.0	31.5	21.0	5µm

	Model No.	ER Size	ØD	L	ØD1	Accuracy
GERC25	GERC25-2.0	25	2.0	34.0	26.0	5µm
	GERC25-3.0	25	3.0	34.0	26.0	5µm
	GERC25-4.0	25	4.0	34.0	26.0	5µm
	GERC25-5.0	25	5.0	34.0	26.0	5µm
	GERC25-6.0	25	6.0	34.0	26.0	5µm
	GERC25-7.0	25	7.0	34.0	26.0	5µm
	GERC25-8.0	25	8.0	34.0	26.0	5µm
	GERC25-9.0	25	9.0	34.0	26.0	5µm
	GERC25-10.0	25	10.0	34.0	26.0	5µm
	GERC25-11.0	25	11.0	34.0	26.0	5µm
	GERC25-12.0	25	12.0	34.0	26.0	5µm
	GERC25-13.0	25	13.0	34.0	26.0	5µm
GERC32	GERC32-2.0	32	2.0	40	33.0	5µm
	GERC32-3.0	32	3.0	40	33.0	5µm
	GERC32-4.0	32	4.0	40	33.0	5µm
	GERC32-5.0	32	5.0	40	33.0	5µm
	GERC32-6.0	32	6.0	40	33.0	5µm
	GERC32-7.0	32	7.0	40	33.0	5µm
	GERC32-8.0	32	8.0	40	33.0	5µm
	GERC32-9.0	32	9.0	40	33.0	5µm
	GERC32-10.0	32	10.0	40	33.0	5µm
	GERC32-11.0	32	11.0	40	33.0	5µm
	GERC32-12.0	32	12.0	40	33.0	5µm
	GERC32-13.0	32	13.0	40	33.0	5µm
GERC40	GERC40-16.0	40	16.0	46.0	41.0	5µm
	GERC40-20.0	40	20.0	46.0	41.0	5µm
	GERC40-25.0	40	25.0	46.0	41.0	5µm

Order example · General type - Order as GERC16-6.0 · Precision type - Order as GERC16-6.OHP · General-type waterproof type - Order as GERC16-6.0C

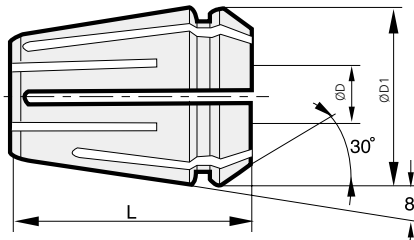
※ Please contact us about precision & water-proof type.

※ Please contact us about GERC40 precision type and other dimensions.



GERC COLLET

GERC collet (precision type)



	Model No.	ER Size	ØD	L	ØD1	Accuracy	
GERC11	GERC11-3.0HP	11	3.0	18.0	11.5	2µm	
	GERC11-4.0HP	11	4.0	18.0	11.5	2µm	
	GERC11-5.0HP	11	5.0	18.0	11.5	2µm	
	GERC11-6.0HP	11	6.0	18.0	11.5	2µm	
GERC16	GERC16-3.0HP	16	3.0	27.5	17.0	2µm	
	GERC16-4.0HP	16	4.0	27.5	17.0	2µm	
	GERC16-5.0HP	16	5.0	27.5	17.0	2µm	
	GERC16-6.0HP	16	6.0	27.5	17.0	2µm	
	GERC16-7.0HP	16	7.0	27.5	17.0	2µm	
	GERC16-8.0HP	16	8.0	27.5	17.0	2µm	
	GERC16-9.0HP	16	9.0	27.5	17.0	2µm	
	GERC16-10.0HP	16	10.0	27.5	17.0	2µm	
	GERC20	GERC20-3.0HP	20	3.0	31.5	21.0	2µm
		GERC20-4.0HP	20	4.0	31.5	21.0	2µm
GERC20-5.0HP		20	5.0	31.5	21.0	2µm	
GERC20-6.0HP		20	6.0	31.5	21.0	2µm	
GERC20-8.0HP		20	8.0	31.5	21.0	2µm	
GERC20-9.0HP		20	9.0	31.5	21.0	2µm	
GERC20-10.0HP		20	10.0	31.5	21.0	2µm	
GERC20-11.0HP		20	11.0	31.5	21.0	2µm	
GERC20-12.0HP		20	12.0	31.5	21.0	2µm	
GERC20-13.0HP		20	13.0	31.5	21.0	2µm	
GERC25	GERC25-6.0HP	25	6.0	34.0	26.0	2µm	
	GERC25-10.0HP	25	10.0	34.0	26.0	2µm	
	GERC25-12.0HP	25	12.0	34.0	26.0	2µm	
	GERC25-14.0HP	25	14.0	34.0	26.0	2µm	
	GERC25-16.0HP	25	16.0	34.0	26.0	2µm	
GERC32	GERC32-6.0HP	32	6.0	44.0	33.0	2µm	
	GERC32-10.0HP	32	10.0	44.0	33.0	2µm	
	GERC32-12.0HP	32	12.0	44.0	33.0	2µm	
	GERC32-16.0HP	32	16.0	44.0	33.0	2µm	
	GERC32-18.0HP	32	18.0	44.0	33.0	2µm	
GERC32-20.0HP	32	20.0	44.0	33.0	2µm		

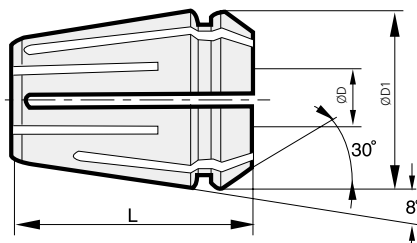
Order example · General type - **Order as GERC16-6.0** · Precision type - **Order as GERC16-6.0HP** · General-type waterproof type - **Order as GERC16-6.0C**

- ※ Please contact us about precision & water-proof type.
- ※ Please contact us about GERC40 precision type and other dimensions.



GERC COLLET

GERC collet (waterproof-type general type)



	Model No.	ER Size	ØD	L	ØD1	Accuracy
GERC16	GERC16-5.0C	16	5.0	27.5	17.0	5µm
	GERC16-6.0C	16	6.0	27.5	17.0	5µm
	GERC16-8.0C	16	8.0	27.5	17.0	5µm
	GERC16-10.0C	16	10.0	27.5	17.0	5µm
GERC20	GERC20-6.0C	20	6.0	31.5	21.0	5µm
	GERC20-8.0C	20	8.0	31.5	21.0	5µm
	GERC20-10.0C	20	10.0	31.5	21.0	5µm
	GERC20-12.0C	20	12.0	31.5	21.0	5µm
GERC25	GERC25-6.0C	25	6.0	34.0	26.0	5µm
	GERC25-8.0C	25	8.0	34.0	26.0	5µm
	GERC25-10.0C	25	10.0	34.0	26.0	5µm
	GERC25-12.0C	25	12.0	34.0	26.0	5µm
	GERC25-14.0C	25	14.0	34.0	26.0	5µm
GERC32	GERC25-16.0C	25	16.0	34.0	26.0	5µm
	GERC32-8.0C	32	8.0	44.0	33.0	5µm
	GERC32-9.0C	32	9.0	44.0	33.0	5µm
	GERC32-10.0C	32	10.0	44.0	33.0	5µm
	GERC32-11.0C	32	11.0	44.0	33.0	5µm
	GERC32-12.0C	32	12.0	44.0	33.0	5µm
	GERC32-13.0C	32	13.0	44.0	33.0	5µm
	GERC32-14.0C	32	14.0	44.0	33.0	5µm
	GERC32-16.0C	32	16.0	44.0	33.0	5µm
	GERC32-18.0C	32	18.0	44.0	33.0	5µm
GERC32-20.0C	32	20.0	44.0	33.0	5µm	

Order example · General type - **Order as GERC16-6.0** · Precision type - **Order as GERC16-6.0HP** · General-type waterproof type - **Order as GERC16-6.0C**

- ※ Please contact us about precision & water-proof type.
- ※ Please contact us about GERC40 precision type and other dimensions.



GERC COLLET SET

GERC collet set (general type)



Model No.	∅D	Clearance	Collet quantity	Accuracy	Kg	Package weight (Kg)
GERC11 (SET)	1.0-7.0	0.5	13pcs	5μm	0.1	0.3
GERC16 (SET)	1.0-10.0	1.0	10pcs	5μm	0.2	0.4
GERC20 (SET)	2.0-13.0	1.0	12pcs	5μm	0.5	0.8
GERC25 (SET)	2.0-16.0	1.0	15pcs	5μm	1.1	1.5
GERC32 (SET)	3.0-20.0	1.0	18pcs	5μm	2.6	3.1
GERC40 (SET)	4.0-26.0	1.0	23pcs	5μm	5.8	6.9

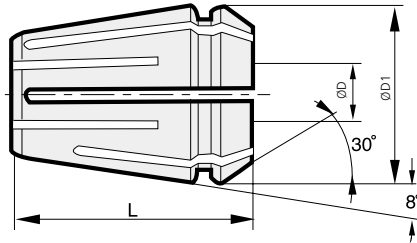
Chuck
 Arbor / Modular
 Boring tool
 Angular head
 cBN/PCD
 Smart factory
 TAUMAX
 OTHER





ER COLLET

ER collet (general type)



	Model No.	ER Size	ØD	L	ØD1	Accuracy
ER11	ER11-1.0	11	1.0	18.0	11.5	10 μ m
	ER11-1.5	11	1.5	18.0	11.5	10 μ m
	ER11-2.0	11	2.0	18.0	11.5	10 μ m
	ER11-2.5	11	2.5	18.0	11.5	10 μ m
	ER11-3.0	11	3.0	18.0	11.5	10 μ m
	ER11-3.5	11	3.5	18.0	11.5	10 μ m
	ER11-4.0	11	4.0	18.0	11.5	10 μ m
	ER11-4.5	11	4.5	18.0	11.5	10 μ m
	ER11-5.0	11	5.0	18.0	11.5	10 μ m
	ER11-5.5	11	5.5	18.0	11.5	10 μ m
	ER11-6.0	11	6.0	18.0	11.5	10 μ m
	ER11-6.5	11	6.5	18.0	11.5	10 μ m
	ER11-7.0	11	7.0	18.0	11.5	10 μ m
	ER16	ER16-1.0	16	1.0	27.5	17.0
ER16-2.0		16	2.0	27.5	17.0	10 μ m
ER16-3.0		16	3.0	27.5	17.0	10 μ m
ER16-4.0		16	4.0	27.5	17.0	10 μ m
ER16-5.0		16	5.0	27.5	17.0	10 μ m
ER16-6.0		16	6.0	27.5	17.0	10 μ m
ER16-7.0		16	7.0	27.5	17.0	10 μ m
ER16-8.0		16	8.0	27.5	17.0	10 μ m
ER16-9.0		16	9.0	27.5	17.0	10 μ m
ER16-10.0		16	10.0	27.5	17.0	10 μ m
ER20	ER20-1.0	20	1.0	31.5	21.0	10 μ m
	ER20-2.0	20	2.0	31.5	21.0	10 μ m
	ER20-3.0	20	3.0	31.5	21.0	10 μ m
	ER20-4.0	20	4.0	31.5	21.0	10 μ m
	ER20-5.0	20	5.0	31.5	21.0	10 μ m
	ER20-6.0	20	6.0	31.5	21.0	10 μ m
	ER20-7.0	20	7.0	31.5	21.0	10 μ m
	ER20-8.0	20	8.0	31.5	21.0	10 μ m
	ER20-9.0	20	9.0	31.5	21.0	10 μ m
	ER20-10.0	20	10.0	31.5	21.0	10 μ m
	ER20-11.0	20	11.0	31.5	21.0	10 μ m
	ER20-12.0	20	12.0	31.5	21.0	10 μ m
	ER20-13.0	20	13.0	31.5	21.0	10 μ m

Order example · General type - Order using ER16-6.0 · General & water-proof type - Order using ER16-6.0C

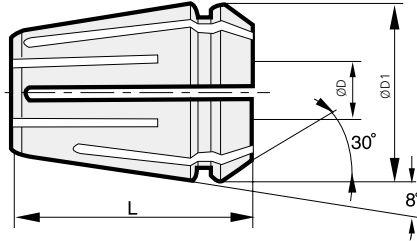
※ Please contact us about other dimensions.

※ The (C) type is a water-proof ER collet.



ER COLLET

ER Collet (General type)



Model No.	ER Size	ØD	L	ØD1	Accuracy
ER25-2.0	25	2.0	34.0	26.0	10µm
ER25-3.0	25	3.0	34.0	26.0	10µm
ER25-4.0	25	4.0	34.0	26.0	10µm
ER25-5.0	25	5.0	34.0	26.0	10µm
ER25-6.0	25	6.0	34.0	26.0	10µm
ER25-7.0	25	7.0	34.0	26.0	10µm
ER25-8.0	25	8.0	34.0	26.0	10µm
ER25-9.0	25	9.0	34.0	26.0	10µm
ER25-10.0	25	10.0	34.0	26.0	10µm
ER25-11.0	25	11.0	34.0	26.0	10µm
ER25-12.0	25	12.0	34.0	26.0	10µm
ER25-13.0	25	13.0	34.0	26.0	10µm
ER25-14.0	25	14.0	34.0	26.0	10µm
ER25-15.0	25	15.0	34.0	26.0	10µm
ER25-16.0	25	16.0	34.0	26.0	10µm
ER32-2.0	32	2.0	40.0	33.0	10µm
ER32-3.0	32	3.0	40.0	33.0	10µm
ER32-4.0	32	4.0	40.0	33.0	10µm
ER32-5.0	32	5.0	40.0	33.0	10µm
ER32-6.0	32	6.0	40.0	33.0	10µm
ER32-7.0	32	7.0	40.0	33.0	10µm
ER32-8.0	32	8.0	40.0	33.0	10µm
ER32-9.0	32	9.0	40.0	33.0	10µm
ER32-10.0	32	10.0	40.0	33.0	10µm
ER32-11.0	32	11.0	40.0	33.0	10µm
ER32-12.0	32	12.0	40.0	33.0	10µm
ER32-13.0	32	13.0	40.0	33.0	10µm
ER32-14.0	32	14.0	40.0	33.0	10µm
ER32-15.0	32	15.0	40.0	33.0	10µm
ER32-16.0	32	16.0	40.0	33.0	10µm
ER32-17.0	32	17.0	40.0	33.0	10µm
ER32-18.0	32	18.0	40.0	33.0	10µm
ER32-19.0	32	19.0	40.0	33.0	10µm
ER32-20.0	32	20.0	40.0	33.0	10µm

Order example · General type - **Order as ER16-6.0** · General type waterproof type - **Order as ER16-6.0C**

- ※ Please contact us about other sizes.
- ※ The (C) type is a water-proof ER collet.

Chuck

Arbor / Modular

Boring tool

Angular head

cBN/PCD

Smart factory

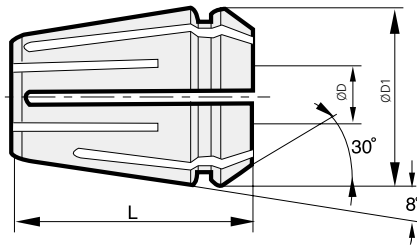
TAUMAX

OTHER



ER COLLET

ER collet (waterproof type)



	Model No.	ER Size	ØD	L	ØD1	Accuracy
ER16	ER16-5.0C	16	5.0	27.5	17.0	10µm
	ER16-6.0C	16	6.0	27.5	17.0	10µm
	ER16-8.0C	16	8.0	27.5	17.0	10µm
	ER16-10.0C	16	10.0	27.5	17.0	10µm
ER20	ER20-6.0C	11	6.0	18.0	11.5	10µm
	ER20-8.0C	11	8.0	18.0	11.5	10µm
	ER20-10.0C	11	10.0	18.0	11.5	10µm
	ER20-12.0C	11	12.0	18.0	11.5	10µm
ER25	ER25-6.0C	20	6.0	31.5	21.0	10µm
	ER25-8.0C	20	8.0	31.5	21.0	10µm
	ER25-10.0C	20	10.0	31.5	21.0	10µm
	ER25-12.0C	20	12.0	31.5	21.0	10µm
	ER25-14.0C	20	14.0	31.5	21.0	10µm
ER32	ER25-16.0C	20	16.0	31.5	21.0	10µm
	ER32-8.0C	32	8.0	40.0	33.0	10µm
	ER32-9.0C	32	9.0	40.0	33.0	10µm
	ER32-10.0C	32	10.0	40.0	33.0	10µm
	ER32-11.0C	32	11.0	40.0	33.0	10µm
	ER32-12.0C	32	12.0	40.0	33.0	10µm
	ER32-13.0C	32	13.0	40.0	33.0	10µm
	ER32-14.0C	32	14.0	40.0	33.0	10µm
	ER32-15.0C	32	15.0	40.0	33.0	10µm
	ER32-16.0C	32	16.0	40.0	33.0	10µm
	ER32-18.0C	32	18.0	40.0	33.0	10µm
ER32-20.0C	32	20.0	40.0	33.0	10µm	

Order example · General type - Order using ER16-6.0 · General & water-proof type - Order using ER16-6.0C

※ Please contact us about other dimensions.

※ The (C) type is a water-proof ER collet.



ER/L

Lock collet for ER collet chuck



Features

- Designed to prevent the end mill from falling out
- Prevents tool fallout, slipping, or idle running
- Uses the Weldon flat (DIN 6535HB) end mill without any special end mill
- Useful for machining large-sized mold or difficult-to-cut materials

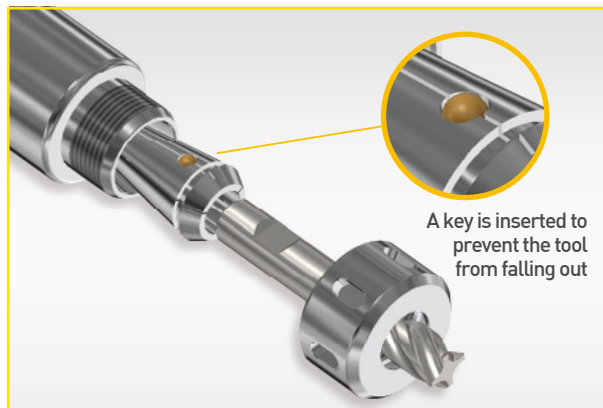
NAMING	ER	20	12.0	L
	ER Collet	Collet Size	Tool Dia.	Lock



Structural Features

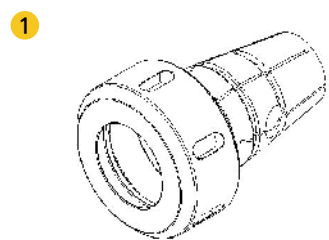
Designed to prevent fallout

- Tool fallout is prevented by a key inserted in the collet.
- A key is inserted to prevent the tool from falling out

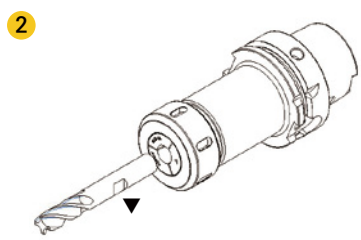


How to use

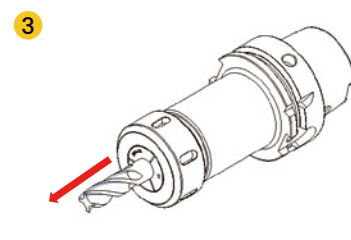
- Assemble the collet with nut (same for general ER collet in use)
- Assemble the end tool (in the direction of assembling notch with key)
- Tighten the nut with the body



Combine the non-slip ER collet with nut.



Clamp the nut after inserting no. 1 into the collet chuck. After that, insert the end mill notch to be aligned with the part ▼ (steel ball position).



After checking that the steel ball in the collet is caught in the notched part, completely clamp the nut by pulling the end mill in the axial direction (arrow direction)

Note If an auto clamp device is used, skip step 3. (End mill rotation may cause injury.)

Applicable end mill



〈DIN6535 specifications end mill〉

- For more information on the detailed specifications, see **85p**

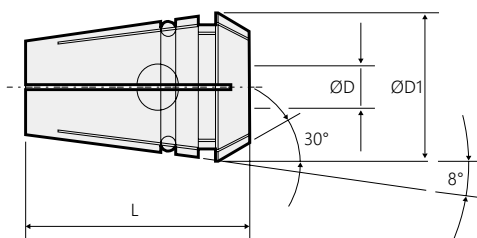


ER/L

Lock collet for ER collet chuck



Detailed Specifications



	Model No.	ØD	ØD	ØD1	L
ER20L	ER20-6L	20	6	20.7	31.5
	ER20-8L	20	8	20.7	31.5
	ER20-10L	20	10	20.7	31.5
	ER20-12L	20	12	20.7	31.5
ER32L	ER32-12L	32	12	32.7	40
	ER32-16L	32	16	32.7	40
	ER32-20L	32	20	32.7	40

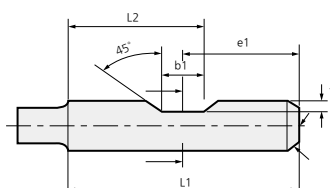
※ For DIN ISO 15488-A standard



Notched Endmill

Notched Endmill

Detailed Specifications



Tool Ø	Tool (DIN6535)				
	L1	e1	b1	L2	t
6	36	18	4.2	20.1	0.9
8	36	18	5.5	20.75	1.1
10	40	20	7	23.5	1.5
12	45	22.5	8	26.5	1.6
14	45	22.5	8	26.5	1.3
16	48	24	10	29	1.8
18	48	24	10	29	1.8
20	50	25	11	30.5	1.8
25	56	32	12	30	2
32	60	36	14	31	2

※ DIN 6535 specifications end mill used ※ As a separate purchase, it can be referred to when using ERL/L collet.



RTJW

Jet coolant disk



Features

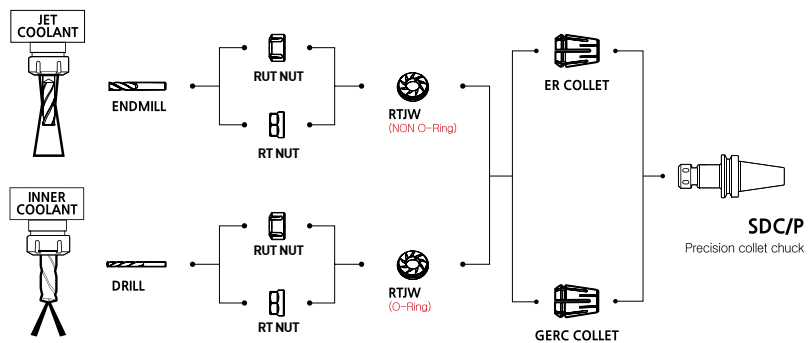
- Provides a longer cutting tool service life by preventing chips from adhering to the tool
- Improves chip breakability/breaking strong jet injection
- Reduces equipment non-operation time as nozzle position change is not necessary

NAMING	RTJW	16	—	6
	Jet Coolant Disk	ER Collet Size		Tool Dia.

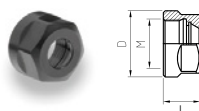


Application

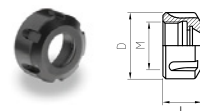
- With one waterproof type (RT, RUT) NUT, the inside jet coolant is simultaneously used
- Enables a fast change of the inside jet coolant only by disk replacement
- Strong jet injection with no scattering even in the high-speed rotation



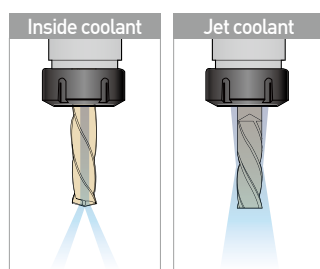
RT NUT			
TYPE	M	D	L
RT16	M22x1.50	28.0	22.5



RUT NUT			
TYPE	M	D	L
RUT20	M25x1.50	35.0	24.0
RUT25	M32x1.50	42.0	25.0
RUT32	M40x1.50	50.0	27.5
RUT40	M50x1.50	63.0	30.5

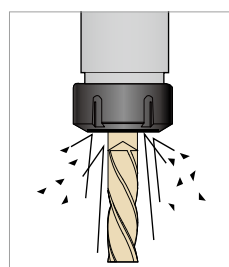


	Pocket machining	After	Remarks
JET COOLANT			▶ The chips in the pocket completely are removed by a strong jet injection.
OUTSIDE COOLANT			▶ The chips in the pocket are not removed. ▶ Chips are accumulated in the collet and nut.



Coolant method

According to use, inside coolant and jet coolant refueling can be used.



Mixing prevention

Effective for vibration proof by preventing mixing of cutting chips by using RTJW.



RTJW

Jet coolant disk



Jet coolant Inside coolant



• For more information on the product features, see **86p**

• For more information on the products to be tightened, see **68p**

※ Less than $\varnothing 5$ cannot be used for production.

	Model No.	ER Size	Inner diameter
RTJW16,20	RTJW16-6	16	6
	RTJW16-7	16	7
	RTJW16-8	16	8
	RTJW20-6	20	6
	RTJW20-7	20	7
	RTJW20-8	20	8
	RTJW20-9	20	9
RTJW25	RTJW20-10	20	10
	RTJW25-6	25	6
	RTJW25-7	25	7
	RTJW25-8	25	8
	RTJW25-9	25	9
	RTJW25-10	25	10
	RTJW25-11	25	11
	RTJW25-12	25	12
	RTJW25-13	25	13
	RTJW25-14	25	14
RTJW25-15	25	15	
RTJW25-16	25	16	

	Model No.	ER Size	Inner diameter
RTJW32	RTJW32-6	32	6
	RTJW32-7	32	7
	RTJW32-8	32	8
	RTJW32-9	32	9
	RTJW32-10	32	10
	RTJW32-11	32	11
	RTJW32-12	32	12
	RTJW32-13	32	13
	RTJW32-14	32	14
	RTJW32-15	32	15
	RTJW32-16	32	16
RTJW40	RTJW32-17	32	17
	RTJW32-18	32	18
	RTJW32-20	32	20
	RTJW40-18	40	18
	RTJW40-19	40	19
	RTJW40-20	40	20
	RTJW40-21	40	21
	RTJW40-22	40	22
RTJW40-24	40	24	

Chuck

Arbor / Modular

Boring tool

Angular head

cBN/PCD

Smart factory

TAUMAX

OTHER



DSK

Slim type collet chuck



G6.3	15,000	Ø25	C		
G value	Max RPM	Max Dia	Coolant System	Milling	Drilling

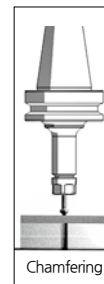
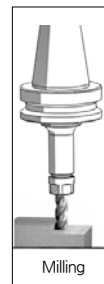
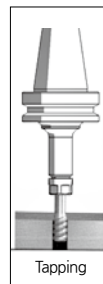
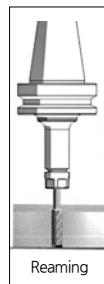
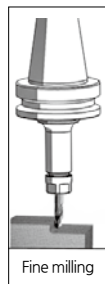
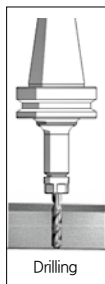
Features

- Enables balanced G6.3/ a maximum of 15,000RPM machining
- Minimized tool vibration during machining by adopting an 8-degree collet
- Provides optimal machining stability by applying Swiss Made nuts
- Tool clamping range : Ø2-Ø25

NAMING	BT30	—	DSK	—	10	—	90
	Spindle		Slim type Collet Chuck		Tool Dia.		Length



Multipurpose operation



Collet

General type & Precision type	Model No.	Max Chucking	Runout	8° HC Collet
	HC6 - ØD	6.0	General type 5µm	 Minimizes tool vibration during machining
	HC10 - ØD	10.0		
	HC13 - ØD	13.0	Precision type 3µm	
	HC16 - ØD	16.0		
	HC20 - ØD	20.0		
	HC25 - ØD	25.0		

Spanner(optional)

	Model No.	Chuck
	DSS - 6	DSK 6
	DSS - 10	DSK 10
	DSS - 13	DSK 13
	DSS - 16	DSK 16
	DSS - 20	DSK 20
	DSS - 25	DSK 25

Collet extract tool

	Model No.	Chuck
	DSS - 6CE	DSK 6
	DSS - 10CE	DSK 10
	DSS - 13CE	DSK 13
	DSS - 16CE	DSK 16
	DSS - 20CE	DSK 20
	DSS - 25CE	DSK 25

C Internal coolant system is optional.

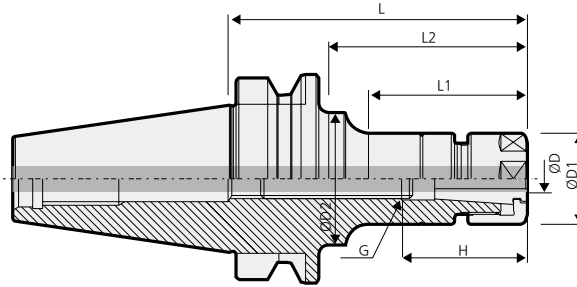


BT-DSK

Slim type collet chuck



MAS 403-BT	G6.3	15,000	Ø25	C	Milling	Drilling
Shank	G value	Max RPM	Max Dia	Coolant System	Milling	Drilling



- For more information on the product features, see **88p**
- For more information on the related parts, see **91p**
- For more information on the applicable collet, see **98p**

※ If a coolant system is used, use a coolant collet.

	Model No.	ØD	L	ØD1	ØD2	L1	L2	H	COLLET	G	RPM	Kg	Package weight (Kg)
BT30	BT30-DSK6-60	3.0~6.0	60	19.5	19.5	33	33	31	HC6	M8	15,000	0.4	0.5
	BT30-DSK6-90	3.0~6.0	90	19.5	32	56	65	31	HC6	M8	15,000	0.5	0.6
	BT30-DSK10-60	2.0~10.0	60	27.5	27.5	35	35	38	HC10	M12	15,000	0.5	0.6
	BT30-DSK10-90	2.0~10.0	90	27.5	27.5	65	65	38	HC10	M12	15,000	0.6	0.7
	BT30-DSK13-60	3.0~13.0	60	33	33	36	36	43	HC13	M12	15,000	0.5	0.6
	BT30-DSK16-60	3.0~16.0	60	40	40	37	37	52	HC16	M12	15,000	0.6	0.7
	BT30-DSK16-90	3.0~16.0	90	40	40	67	67	52	HC16	M18	15,000	0.8	0.9
	BT30-DSK25-90	16.0~25.0	90	55	55	67.5	67.5	63.5	HC25	M12	15,000	0.9	1.1
BT40	BT40-DSK6-90	3.0~6.0	90	19.5	32	51	61	31	HC6	M8	10,000	1.1	1.3
	BT40-DSK6-120	3.0~6.0	120	19.5	32	60	90	31	HC6	M8	10,000	1.1	1.3
	BT40-DSK6-150	3.0~6.0	150	19.5	25	60	120	31	HC6	M8	10,000	1.1	1.4
	BT40-DSK10-90	2.0~10.0	90	27.5	40	48	60	38	HC10	M12	10,000	1.2	1.4
	BT40-DSK10-120	2.0~10.0	120	27.5	40	73	90	38	HC10	M12	10,000	1.2	1.5
	BT40-DSK10-150	2.0~10.0	150	27.5	34.5	73	118	38	HC10	M12	10,000	1.4	1.7
	BT40-DSK13-90	3.0~13.0	90	33	33	59	59	43	HC13	M15	10,000	1.3	1.5
	BT40-DSK16-90	3.0~16.0	90	40	40	58	58	52	HC16	M18	10,000	1.3	1.5
	BT40-DSK16-120	3.0~16.0	120	40	40	88	88	52	HC16	M18	10,000	1.5	1.7
	BT40-DSK16-150	3.0~16.0	150	40	40	118	118	52	HC16	M18	10,000	1.9	2.1
	BT40-DSK20-90	4.0~20.0	90	48.5	48.5	60	60	60	HC20	M22	10,000	1.5	1.7
	BT40-DSK20-120	4.0~20.0	120	48.5	48.5	90	90	60	HC20	M22	10,000	1.8	2.0
	BT40-DSK25-90	16.0~25.0	90	55	55	61	61	63.5	HC25	M28	10,000	1.6	1.8
BT40-DSK25-120	16.0~25.0	120	55	55	91	91	85	HC25	M28	10,000	2.0	2.3	

C Internal coolant system is optional.

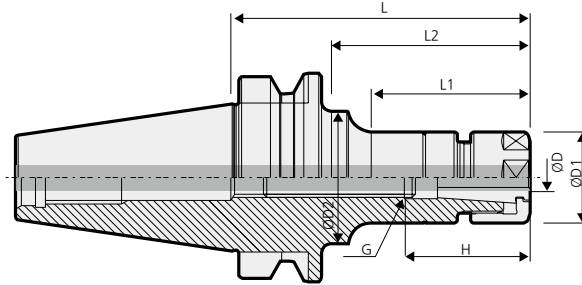


BT-DSK

Slim type collet chuck



MAS 403-BT	G6.3	15,000	Ø25	C		
Shank	G value	Max RPM	Max Dia	Coolant System	Milling	Drilling



- For more information on the product features, see **88p**.
- For more information on the related parts, see **91p**.
- For more information on the applicable collet, see **98p**.

※ If a coolant system is used, use a coolant collet.

Model No.	ØD	L	ØD1	ØD2	L1	L2	H	COLLET	G	RPM	Kg	Package weight (Kg)
BT50-DSK6-105	3.0~6.0	105	19.5	32	55	64	31	HC6	M8	8,000	3.6	3.9
BT50-DSK6-135	3.0~6.0	135	19.5	32	60	92	31	HC6	M8	8,000	3.7	4.1
BT50-DSK6-165	3.0~6.0	165	19.5	32	60	114	31	HC6	M8	8,000	4.1	4.4
BT50-DSK10-105	2.0~10.0	105	27.5	27.5	57	57	38	HC10	M12	8,000	3.8	4.1
BT50-DSK10-135	2.0~10.0	135	27.5	32	70	92	38	HC10	M12	8,000	3.9	4.3
BT50-DSK10-165	2.0~10.0	165	27.5	36	75	114	38	HC10	M12	8,000	4.1	4.5
BT50-DSK13-135	3.0~13.0	135	33	33	92	92	43	HC13	M15	8,000	3.8	4.2
BT50-DSK16-105	3.0~16.0	105	40	40	62	62	52	HC16	M18	8,000	4.0	4.3
BT50-DSK16-135	3.0~16.0	135	40	40	92	92	52	HC16	M18	8,000	4.2	4.6
BT50-DSK16-165	3.0~16.0	165	40	50	40	122	52	HC16	M18	8,000	4.6	5.0
BT50-DSK20-105	4.0~20.0	105	48	40	62	62	60	HC20	M22	8,000	4.2	4.5
BT50-DSK20-135	4.0~20.0	135	48	40	92	92	60	HC20	M22	8,000	4.5	4.9
BT50-DSK20-165	4.0~20.0	165	48	40	122	122	60	HC20	M22	8,000	4.9	5.3
BT50-DSK25-105	16.0~25.0	105	55	55	62	62	63.5	HC25	M28	8,000	4.4	4.7
BT50-DSK25-135	16.0~25.0	135	55	55	92	92	63.5	HC25	M28	8,000	4.5	4.9
BT50-DSK25-165	16.0~25.0	165	55	55	122	122	63.5	HC25	M28	8,000	5.2	5.6

C Internal coolant system is optional.

1:1 Chat






DSK SPARE PART

Slim collet chuck related parts




Main components

Spare Part			
Main components			
Type	Nut	Adjust screw	Extraction tool
Images			
Model No.			
DSK6	DN6	BN0825	DSK-6CE
DSK10	DN10	BN1230	DSK-10CE
DSK13	DN13	BN1230(BT30) / BN1524F(Others)	DSK-13CE
DSK16	DN16	BN1830F	DSK-16CE
DSK20	DN20	BN2230F	DSK-20CE
DSK25	DN25	BN2838F	DSK-25CE

※ BN1230 screws are used for BT30-DSK25-90.

For separate purchase

Spare Part		
For separate purchase		
Images	Applicable chuck	Spanner Model No.
	DSK6	DSS-6
	DSK10	DSS-10
	DSK13	DSS-13
	DSK16	DSS-16
	DSK20	DSS-20
	DSK25	DSS-25

1:1 Chat

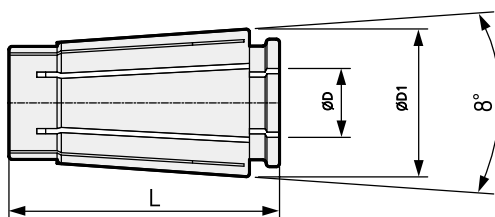


HC COLLET

HC Slim collet (General & precision type)



For separate purchase



Model No.	ØD1	L	MAX. ØD	Clearance	General	Precision (P)
HC6 ØD(P)	10.5	25.0	6.0	1.0	5µm	3µm
HC10 ØD(P)	15.6	30.5	10.0	1.0	5µm	3µm
HC13 ØD(P)	20.1	39.0	13.0	1.0	5µm	3µm
HC16 ØD(P)	24.6	45.0	16.0	1.0	5µm	3µm
HC20 ØD(P)	29.2	54.3	20.0	1.0	5µm	3µm
HC25 ØD(P)	35.7	57.0	25.0	1.0	5µm	3µm

Order Example · General type - Order as HC16-8.0
· Precision type - Order as HC16-8.0P

· For more information on the detailed specifications, see **98p**



GSK

Great speed slim collet chuck



G2.5	25,000	Ø25	C		
G value	Max RPM	Max Dia	Coolant System	Milling	Drilling

Features

- Enables balanced G2.5/a maximum of 25,000RPM machining
- Improves machining productivity by high-speed machining
- Minimized tool vibration during machining by adopting an 8-degree collet
- The collet is pressed steadily by the Swiss Made high-accuracy nut.
- Optimal machining stability
- Tool clamping range : Ø2-Ø25

NAMING	BT40	—	GSK	10	—	90
	Spindle		Great Speed Slim collet chuck	Tool Dia.		Length



Unique Design

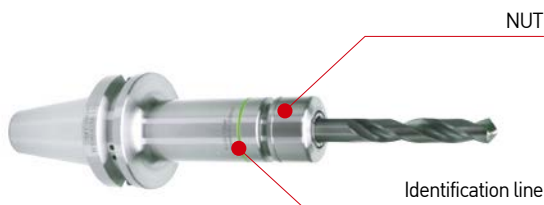
GSK	Third party
<p>Planar part fixing method</p> <p>8° HC Collet</p> <p>Nuts for high-speed rotation</p> <p>Provides strong tightening force with a 8° collet and good fixation degree based on planar part fixing method</p>	<p>Vibration due to balance instability</p> <p>Unstable balance is generated by the centrifugal force at the time of high-speed rotation</p>

Comparison of screw polishing at points of nut tightened

GSK	Third party
<p>Provides excellent reproduction precision through screw grinding</p>	<p>Unstable precision due to turning operation</p>

Special Design

Optimized for great-speed collet chucks and uniquely designed to enable easy runout measurement by designating the test bar area to the product



Spanner(optional)



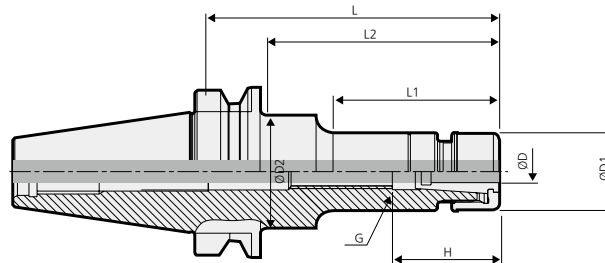
Model No.	GSK
GSK6 SPANNER	GSK6
GSK10 SPANNER	GSK10
GSK13 SPANNER	GSK13
GSK16 SPANNER	GSK16
GSK20 SPANNER	GSK20
GSK25 SPANNER	GSK25

C Internal coolant system is optional.



BT-GSK

Great slim type collet chuck



- For more information on the product features, see **92p**
- For more information on the related parts, see **97p**
- For more information on the applicable collet, see **98p**

※ If a coolant system is used, use a coolant collet.

	Model No.	ØD	L	ØD1	ØD2	L1	L2	H	COLLET/STEP	G	RPM	Kg	Package weight (Kg)
BT30	BT30-GSK6-60	3.0~6.0	60	19.5	19.5	33	33	31	HC6/1.0	M8	25,000	0.4	0.4
	BT30-GSK6-90	3.0~6.0	90	19.5	32	56	65	31	HC6/1.0	M8	25,000	0.5	0.6
	BT30-GSK10-60	2.0~10.0	60	27	27	35	35	38	HC10/1.0	M12	25,000	0.5	0.6
	BT30-GSK10-90	2.0~10.0	90	27	27	65	65	38	HC10/1.0	M12	25,000	0.6	0.7
	BT30-GSK13-60	3.0~13.0	60	35	35	36	36	43	HC13/1.0	M12	25,000	0.6	0.7
	BT30-GSK16-60	3.0~16.0	60	40	40	37	37	52	HC16/1.0	M12	25,000	0.6	0.7
	BT30-GSK16-90	3.0~16.0	90	40	40	67	67	52	HC16/1.0	M18	25,000	0.8	0.9
	BT30-GSK25-90	16.0~25.0	90	55	55	67.5	67.5	63.5	HC25/1.0	M12	25,000	1.0	1.1
BT40	BT40-GSK6-90	3.0~6.0	90	19.5	32	51	61	31	HC6/1.0	M8	20,000	1.0	1.2
	BT40-GSK6-120	3.0~6.0	120	19.5	32	60	90	31	HC6/1.0	M8	20,000	1.2	1.5
	BT40-GSK6-150	3.0~6.0	150	19.5	25	60	120	31	HC6/1.0	M8	20,000	1.2	1.4
	BT40-GSK10-90	2.0~10.0	90	27	40	48	60	38	HC10/1.0	M12	20,000	1.1	1.3
	BT40-GSK10-120	2.0~10.0	120	27	40	73	90	38	HC10/1.0	M12	20,000	1.3	1.5
	BT40-GSK10-150	2.0~10.0	150	27	34.5	73	118	38	HC10/1.0	M12	20,000	1.4	1.6
	BT40-GSK13-90	3.0~13.0	90	35	35	59	59	43	HC13/1.0	M15	20,000	1.2	1.4
	BT40-GSK16-90	3.0~16.0	90	40	40	58	58	52	HC16/1.0	M18	20,000	1.3	1.5
	BT40-GSK16-120	3.0~16.0	120	40	40	88	88	52	HC16/1.0	M18	20,000	1.5	1.7
	BT40-GSK16-150	3.0~16.0	150	40	40	118	118	52	HC16/1.0	M18	20,000	1.8	2.0
	BT40-GSK20-90	4.0~20.0	90	48	48	60	60	60	HC20/1.0	M22	20,000	1.4	1.6
	BT40-GSK20-120	4.0~20.0	120	48	48	90	90	60	HC20/1.0	M22	20,000	1.8	2.0
	BT40-GSK25-90	16.0~25.0	90	55	55	61	61	63.5	HC25/1.0	M28	20,000	1.6	1.8
	BT40-GSK25-120	16.0~25.0	120	55	55	91	91	63.5	HC25/1.0	M28	20,000	2.0	2.2

☐ Internal coolant system is optional.

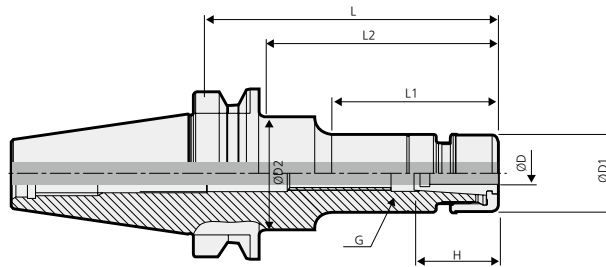


BT-GSK

Great slim type collet chuck



MAS 403-BT	G2.5	15,000	Ø25	C		
Shank	G value	Max RPM	Max Dia	Coolant System	Milling	Drilling



- For more information on the product features, see **92p**.
- For more information on the related parts, see **97p**.
- For more information on the applicable collet, see **98p**.

※ If a coolant system is used, use a coolant collet.

Model No.	ØD	L	ØD1	ØD2	L1	L2	H	COLLET	G	RPM	Kg	Package weight (Kg)
BT50-GSK6-105	3.0~6.0	105	19.5	32	55	64	31	HC6	M8	15,000	3.6	3.9
BT50-GSK6-135	3.0~6.0	135	19.5	32	60	92	31	HC6	M8	15,000	3.6	4.0
BT50-GSK6-165	3.0~6.0	165	19.5	32	60	114	31	HC6	M8	15,000	3.9	4.3
BT50-GSK10-105	2.0~10.0	105	27	27	57	57	38	HC10	M12	15,000	3.7	4.0
BT50-GSK10-135	2.0~10.0	135	27	32	70	92	38	HC10	M12	15,000	3.7	4.1
BT50-GSK10-165	2.0~10.0	165	27	36	75	114	38	HC10	M12	15,000	4.0	4.4
BT50-GSK13-135	3.0~13.0	135	35	35	92	92	43	HC13	M15	15,000	3.9	4.3
BT50-GSK16-105	3.0~16.0	105	40	40	62	62	52	HC16	M18	15,000	3.9	4.2
BT50-GSK16-135	3.0~16.0	135	40	40	92	92	52	HC16	M18	15,000	4.1	4.5
BT50-GSK16-165	3.0~16.0	165	40	50	40	122	52	HC16	M18	15,000	4.3	4.7
BT50-GSK20-105	4.0~20.0	105	48	-	62	62	60	HC20	M22	15,000	4.1	4.4
BT50-GSK20-135	4.0~20.0	135	48	-	92	92	60	HC20	M22	15,000	4.4	4.8
BT50-GSK20-165	4.0~20.0	165	48	-	122	122	60	HC20	M22	15,000	4.9	5.1
BT50-GSK25-105	16.0~25.0	105	55	55	62	62	63.5	HC25	M28	15,000	4.2	4.5
BT50-GSK25-135	16.0~25.0	135	55	55	92	92	63.5	HC25	M28	15,000	4.6	5.0
BT50-GSK25-165	16.0~25.0	165	55	55	122	122	63.5	HC25	M28	15,000	5.1	5.5

C Internal coolant system is optional.

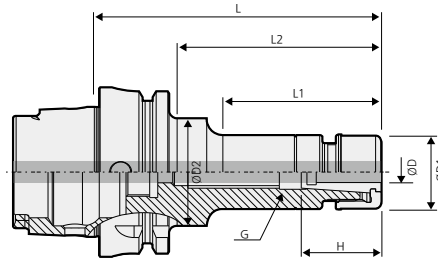


HSK-GSK

Great slim type collet chuck



DIN 69893-1	G2.5	20,000	Ø25	C		
Shank	G value	Max RPM	Max Dia	Coolant System	Milling	Drilling



- For more information on the product features, see **92p**
- For more information on the related parts, see **97p**
- For more information on the applicable collet, see **98p**

※ If a coolant system is used, use a coolant collet.

	Model No.	ØD	L	ØD1	ØD2	L1	L2	H	COLLET	G	RPM	Kg	Package weight (Kg)
HSK63A	HSK63A-GSK6-100	3.0~6.0	100	19.5	32	51	71	31	HC6	M8	20,000	0.8	1.0
	HSK63A-GSK10-105	2.0~10.0	105	27	34.5	59	76	38	HC10	M12	20,000	0.9	1.2
	HSK63A-GSK16-120	3.0~16.0	120	40	40	89	89	52	HC16	M18	20,000	1.3	1.5
	HSK63A-GSK20-120	4.0~20.0	120	48	48	93	93	60	HC20	M22	20,000	1.6	1.8
HSK100A	HSK100A-GSK6-120	3.0~6.0	120	19.5	32	69	86	31	HC6	M8	15,000	2.2	2.6
	HSK100A-GSK10-120	2.0~10.0	120	27	27	69	86	38	HC10	M12	15,000	2.3	2.7
	HSK100A-GSK16-140	3.0~16.0	140	40	40	106	106	52	HC16	M18	15,000	2.8	3.1
	HSK100A-GSK25-155	16.0~25.0	155	55	55	121	121	63.5	HC25	M28	15,000	3.6	4.0

C Internal coolant system is optional.

For separate purchase

Internal coolant system



Classification by shank

HSK50	HSK50A-CNS
HSK63	HSK63A-CNS
HSK100	HSK100A-CNS

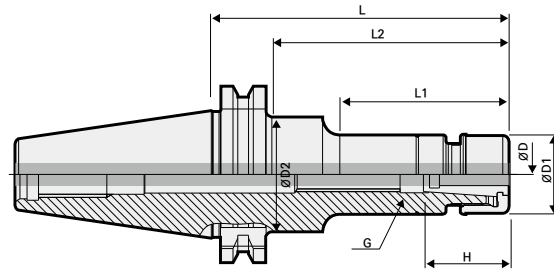


SK-GSK

Great slim type collet chuck



DIN69871 -1A/B	G2.5	20,000	Ø25	C	Milling	Drilling
Shank	G value	Max RPM	Max Dia	Coolant System	Milling	Drilling



- For more information on the product features, see **92p**.
- For more information on the related parts, see **97p**.
- For more information on the applicable collet, see **98p**.

※ If a coolant system is used, use a coolant collet.

	Model No.	ØD	L	ØD1	ØD2	L1	L2	H	COLLET	G	RPM	Kg	Package weight (kg)
SK40	SK40-GSK6-60	3.0~6.0	60	19.5	32	-	-	31	HC6	M8	20,000	0.8	1.0
	SK40-GSK6-90	3.0~6.0	90	19.5	32	51	61	31	HC6	M8	20,000	1.0	1.2
	SK40-GSK10-90	2.0~10.0	90	27	40	48	60	38	HC10	M12	20,000	1.1	1.3
	SK40-GSK10-150	2.0~10.0	150	27	34.5	73	118	38	HC10	M12	20,000	1.3	1.6
	SK40-GSK16-90	3.0~16.0	90	40	40	58	58	52	HC16	M18	20,000	1.2	1.4
	SK40-GSK16-150	3.0~16.0	150	40	40	118	118	52	HC16	M18	20,000	1.7	2.0
	SK40-GSK20-90	4.0~20.0	90	48	48	60	60	60	HC20	M22	20,000	1.3	1.5
	SK40-GSK25-90	16.0~25.0	90	55	55	61	61	63.5	HC25	M28	20,000	1.3	1.5
SK50	SK50-GSK6-105	3.0~6.0	105	19.5	32	55	64	31	HC6	M8	15,000	3.1	3.4
	SK50-GSK6-165	3.0~6.0	165	19.5	32	60	114	31	HC6	M8	15,000	3.3	3.7
	SK50-GSK10-105	2.0~10.0	105	27	27	57	57	38	HC10	M12	15,000	3.2	3.5
	SK50-GSK10-165	2.0~10.0	165	27	36	75	114	38	HC10	M12	15,000	3.4	3.8
	SK50-GSK16-105	3.0~16.0	105	40	40	62	62	52	HC16	M18	15,000	3.4	3.7
	SK50-GSK16-165	3.0~16.0	165	40	50	40	122	52	HC16	M18	15,000	3.9	4.3
	SK50-GSK20-105	4.0~10.0	105	48	40	62	62	60	HC20	M22	15,000	3.6	3.9
	SK50-GSK20-165	4.0~10.0	165	48	40	122	122	60	HC20	M22	15,000	4.3	4.7
	SK50-GSK25-105	16.0~25.0	105	55	55	62	62	63.5	HC25	M28	15,000	3.7	4.0
	SK50-GSK25-165	16.0~25.0	165	55	55	122	122	63.5	HC25	M28	15,000	4.6	5.0

C Internal coolant system is optional.



GSK SPARE PART

Great speed slim collet chuck related parts



Main components

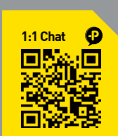
Spare Part			
Main components			
Type	Nut	Adjustment screw	Extraction tool
Images			
Model No.			
GSK6	GN6	BN0825	DSK-6CE
GSK10	GN10	BN1230	DSK-10CE
GSK13	GN13	BN1230(BT30) / BN1524F(Others)	DSK-13CE
GSK16	GN16	BN1830F	DSK-16CE
GSK20	GN20	BN2230F	DSK-20CE
GSK25	GN25	BN2838F	DSK-25CE

※ BN1524F screws are used for HSK63A-GSK20-120.

※ BN1830F screws are used for SK40-GSK20-90.

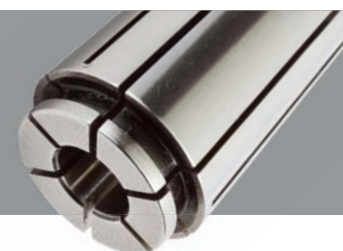
For separate purchase

Spare Part		
For separate purchase		
Images	Applicable chuck	Spanner Model No.
	GSK6	GSK6 SPANNER
	GSK10	GSK10 SPANNER
	GSK13	GSK13 SPANNER
	GSK16	GSK16 SPANNER
	GSK20	GSK20 SPANNER
	GSK25	GSK25 SPANNER

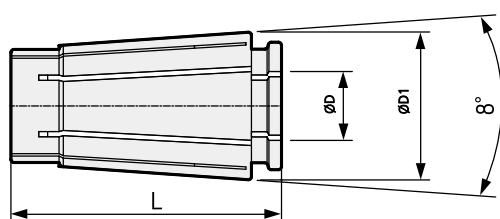


HC COLLET

HC Slim collet (General & precision type)



For separate purchase



Model No.	ØD1	L	MAX. ØD	Clearance	General	Precision (P)
HC6 ØD(P)	10.5	25.0	6.0	1.0	5µm	3µm
HC10 ØD(P)	15.6	30.5	10.0	1.0	5µm	3µm
HC13 ØD(P)	20.1	39.0	13.0	1.0	5µm	3µm
HC16 ØD(P)	24.6	45.0	16.0	1.0	5µm	3µm
HC20 ØD(P)	29.2	54.3	20.0	1.0	5µm	3µm
HC25 ØD(P)	35.7	57.0	25.0	1.0	5µm	3µm

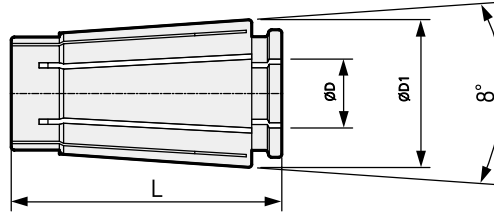
Order Example · General type - **Order as HC16-8.0**
 · Precision type - **Order as HC16-8.0P**

• For more information on the detailed specifications, see **98p**.



HC COLLET

HC slim collet (general type)



	Model No.	ØD1	L	ØD	Clearance	Accuracy
HC6	HC6-3.0	10.5	25.0	3.0	1.0	5µm
	HC6-4.0	10.5	25.0	4.0	1.0	5µm
	HC6-5.0	10.5	25.0	5.0	1.0	5µm
	HC6-6.0	10.5	25.0	6.0	1.0	5µm
HC10	HC10-2.0	15.6	30.5	2.0	1.0	5µm
	HC10-3.0	15.6	30.5	3.0	1.0	5µm
	HC10-4.0	15.6	30.5	4.0	1.0	5µm
	HC10-5.0	15.6	30.5	5.0	1.0	5µm
	HC10-6.0	15.6	30.5	6.0	1.0	5µm
	HC10-7.0	15.6	30.5	7.0	1.0	5µm
	HC10-8.0	15.6	30.5	8.0	1.0	5µm
	HC10-9.0	15.6	30.5	9.0	1.0	5µm
	HC10-10.0	15.6	30.5	10.0	1.0	5µm
	HC13	HC13-3.0	20.1	39.0	3.0	1.0
HC13-4.0		20.1	39.0	4.0	1.0	5µm
HC13-5.0		20.1	39.0	5.0	1.0	5µm
HC13-6.0		20.1	39.0	6.0	1.0	5µm
HC13-7.0		20.1	39.0	7.0	1.0	5µm
HC13-8.0		20.1	39.0	8.0	1.0	5µm
HC13-9.0		20.1	39.0	9.0	1.0	5µm
HC13-10.0		20.1	39.0	10.0	1.0	5µm
HC13-11.0		20.1	39.0	11.0	1.0	5µm
HC13-12.0		20.1	39.0	12.0	1.0	5µm
HC16	HC13-13.0	20.1	39.0	13.0	1.0	5µm
	HC16-3.0	24.6	45.0	3.0	1.0	5µm
	HC16-4.0	24.6	45.0	4.0	1.0	5µm
	HC16-5.0	24.6	45.0	5.0	1.0	5µm
	HC16-6.0	24.6	45.0	6.0	1.0	5µm
	HC16-7.0	24.6	45.0	7.0	1.0	5µm
	HC16-8.0	24.6	45.0	8.0	1.0	5µm
	HC16-9.0	24.6	45.0	9.0	1.0	5µm
	HC16-10.0	24.6	45.0	10.0	1.0	5µm
	HC16-11.0	24.6	45.0	11.0	1.0	5µm
	HC16-12.0	24.6	45.0	12.0	1.0	5µm
	HC16-13.0	24.6	45.0	13.0	1.0	5µm
	HC16-14.0	24.6	45.0	14.0	1.0	5µm
	HC16-15.0	24.6	45.0	15.0	1.0	5µm
HC16-16.0	24.6	45.0	16.0	1.0	5µm	

	Model No.	ØD1	L	ØD	Clearance	Accuracy
HC20	HC20-4.0	29.2	54.3	4.0	2.0	5µm
	HC20-6.0	29.2	54.3	6.0	2.0	5µm
	HC20-8.0	29.2	54.3	8.0	2.0	5µm
	HC20-10.0	29.2	54.3	10.0	2.0	5µm
	HC20-12.0	29.2	54.3	12.0	2.0	5µm
	HC20-14.0	29.2	54.3	14.0	2.0	5µm
	HC20-16.0	29.2	54.3	16.0	2.0	5µm
	HC20-18.0	29.2	54.3	18.0	2.0	5µm
	HC20-20.0	29.2	54.3	20.0	2.0	5µm
	HC25	HC25-16.0	35.7	57.0	16.0	1.0
HC25-17.0		35.7	57.0	17.0	1.0	5µm
HC25-18.0		35.7	57.0	18.0	1.0	5µm
HC25-19.0		35.7	57.0	19.0	1.0	5µm
HC25-20.0		35.7	57.0	20.0	1.0	5µm
HC25-21.0		35.7	57.0	21.0	1.0	5µm
HC25-22.0		35.7	57.0	22.0	1.0	5µm
HC25-23.0		35.7	57.0	23.0	1.0	5µm
HC25-24.0		35.7	57.0	24.0	1.0	5µm
HC25-25.0		35.7	57.0	25.0	1.0	5µm

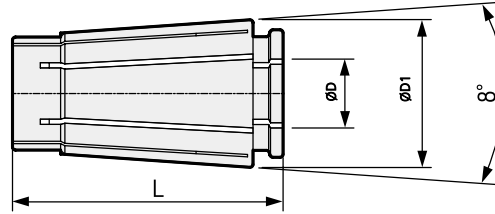
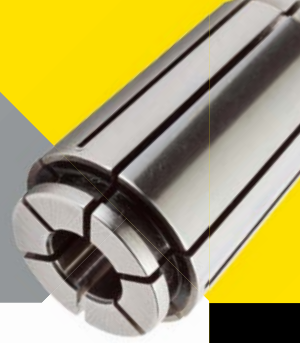
Order Example · General type - Order as **HC16-8.0** · Precision type - Order as **HC16-8.0P**

※ Please contact us about sizes other than the model nos.



HC COLLET

HC slim collet (precision type)



	Model No.	ØD1	L	ØD	Clearance	Accuracy
HC6(P)	HC6-3.0P	10.5	25.0	3.0	1.0	3µm
	HC6-4.0P	10.5	25.0	4.0	1.0	3µm
	HC6-5.0P	10.5	25.0	5.0	1.0	3µm
	HC6-6.0P	10.5	25.0	6.0	1.0	3µm
	HC10-2.0P	15.6	30.5	2.0	1.0	3µm
	HC10-3.0P	15.6	30.5	3.0	1.0	3µm
HC10(P)	HC10-4.0P	15.6	30.5	4.0	1.0	3µm
	HC10-5.0P	15.6	30.5	5.0	1.0	3µm
	HC10-6.0P	15.6	30.5	6.0	1.0	3µm
	HC10-7.0P	15.6	30.5	7.0	1.0	3µm
	HC10-8.0P	15.6	30.5	8.0	1.0	3µm
	HC10-9.0P	15.6	30.5	9.0	1.0	3µm
	HC10-10.0P	15.6	30.5	10.0	1.0	3µm
	HC13(P)	HC13-3.0P	20.1	39.0	3.0	1.0
HC13-4.0P		20.1	39.0	4.0	1.0	3µm
HC13-5.0P		20.1	39.0	5.0	1.0	3µm
HC13-6.0P		20.1	39.0	6.0	1.0	3µm
HC13-7.0P		20.1	39.0	7.0	1.0	3µm
HC13-8.0P		20.1	39.0	8.0	1.0	3µm
HC13-9.0P		20.1	39.0	9.0	1.0	3µm
HC13-10.0P		20.1	39.0	10.0	1.0	3µm
HC13-11.0P		20.1	39.0	11.0	1.0	3µm
HC13-12.0P		20.1	39.0	12.0	1.0	3µm
HC13-13.0P	20.1	39.0	13.0	1.0	3µm	
HC16(P)	HC16-3.0P	24.6	45.0	3.0	1.0	3µm
	HC16-4.0P	24.6	45.0	4.0	1.0	3µm
	HC16-5.0P	24.6	45.0	5.0	1.0	3µm
	HC16-6.0P	24.6	45.0	6.0	1.0	3µm
	HC16-7.0P	24.6	45.0	7.0	1.0	3µm
	HC16-8.0P	24.6	45.0	8.0	1.0	3µm
	HC16-9.0P	24.6	45.0	9.0	1.0	3µm
	HC16-10.0P	24.6	45.0	10.0	1.0	3µm
	HC16-11.0P	24.6	45.0	11.0	1.0	3µm
	HC16-12.0P	24.6	45.0	12.0	1.0	3µm
	HC16-13.0P	24.6	45.0	13.0	1.0	3µm
	HC16-14.0P	24.6	45.0	14.0	1.0	3µm
	HC16-15.0P	24.6	45.0	15.0	1.0	3µm
	HC16-16.0P	24.6	45.0	16.0	1.0	3µm

	Model No.	ØD1	L	ØD	Clearance	Accuracy
HC20(P)	HC20-4.0P	29.2	54.3	4.0	2.0	3µm
	HC20-6.0P	29.2	54.3	6.0	2.0	3µm
	HC20-8.0P	29.2	54.3	8.0	2.0	3µm
	HC20-10.0P	29.2	54.3	10.0	2.0	3µm
	HC20-12.0P	29.2	54.3	12.0	2.0	3µm
	HC20-14.0P	29.2	54.3	14.0	2.0	3µm
	HC20-16.0P	29.2	54.3	16.0	2.0	3µm
	HC20-18.0P	29.2	54.3	18.0	2.0	3µm
HC20-20.0P	29.2	54.3	20.0	2.0	3µm	
HC25(P)	HC25-16.0P	35.7	57.0	16.0	1.0	3µm
	HC25-17.0P	35.7	57.0	17.0	1.0	3µm
	HC25-18.0P	35.7	57.0	18.0	1.0	3µm
	HC25-19.0P	35.7	57.0	19.0	1.0	3µm
	HC25-20.0P	35.7	57.0	20.0	1.0	3µm
	HC25-21.0P	35.7	57.0	21.0	1.0	3µm
	HC25-22.0P	35.7	57.0	22.0	1.0	3µm
	HC25-23.0P	35.7	57.0	23.0	1.0	3µm
	HC25-24.0P	35.7	57.0	24.0	1.0	3µm
	HC25-25.0P	35.7	57.0	25.0	1.0	3µm

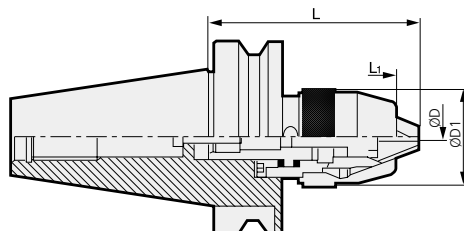
Order Example · General type - Order as **HC16-8.0** · Precision type - Order as **HC16-8.0P**

※ Please contact us about sizes other than the model nos.



BT-NPU

Drill chuck



• For more information on the related parts, see **101p**.

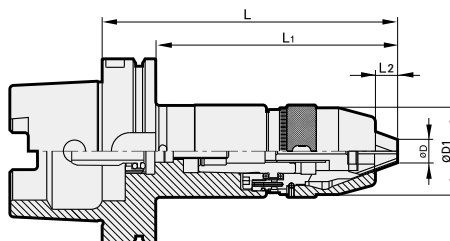
	Model No.	ØD	L	ØD1	L1	Kg	Package weight (Kg)
BT30, BT40, BT50	BT30-NPU8-97	1~8	97	38	8.5	0.8	0.9
	BT30-NPU13-125	1~13	125	50	12.5	1.4	1.6
	BT40-NPU8-87	1~8	87	38	8.5	1.2	1.4
	BT40-NPU13-105	1~13	105	50	12.5	1.6	1.9
	BT40-NPU13-130	1~13	130	50	12.5	1.9	2.2
	BT50-NPU13-130	1~13	130	50	12.5	4.5	4.9
	BT50-NPU13-190	1~13	190	50	12.5	5.3	5.7

C This product does not support the internal coolant system.



HSK-NPU

Drill chuck



• For more information on the related parts, see **101p**.

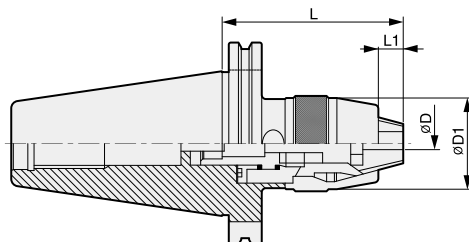
	Model No.	ØD	L	ØD1	L1	L2	Kg	Package weight (Kg)
HSK63A, HSK100A	HSK63A-NPU13-175	1~13	175	50	149	12.5	2.4	2.6
	HSK100A-NPU13-180	1~13	180	50	151	12.5	3.6	4.0

C This product does not support the internal coolant system.



SK-NPU

Drill chuck



• For more information on the related parts, see **101p**

Model No.	ØD	ØD1	L	L1	Kg	Package weight (Kg)
SK40-NPU13-105	1~13	50	105	12.5	1.6	1.8
SK50-NPU13-111	1~13	50	111	12.5	3.6	3.9

SK40, SK50

C This product does not support the internal coolant system.



NPU SPARE PART

Drill chuck related parts

Spare Part		Main components		Spare Part
Type		Drill chuck head	Bolt	For separate purchase Spanner
Model No.	Images			
	NPU8	NPU08	BX0620	NPU0836
	NPU13	NPU16	BX0825	NPU1348



DTN

Tapping holder



Features

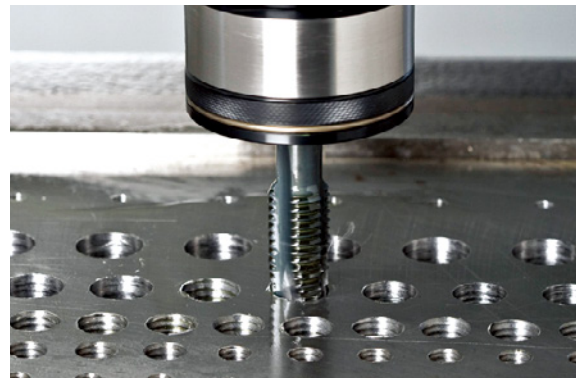
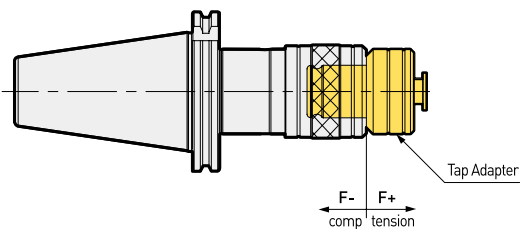
- Fast and convenient tool change
- Using an adapter with a tensile and shrinking device
- Boring range : M3~M38

MAINING	BT40	DTN	22	130
	Spindle	Tapping holder	Tapping Range	Length



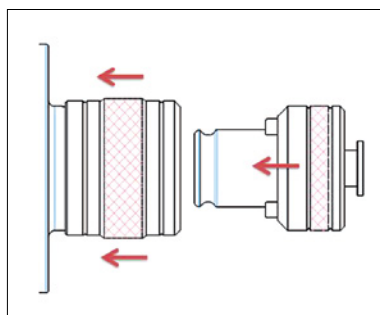
Easy TCA (Tap adapter) change

- Fast tap change per adapter pi based on the one-touch change method that enables high accuracy and a long service life and useful for various machining operations
- Enables tension and contraction using the axial direction floating method



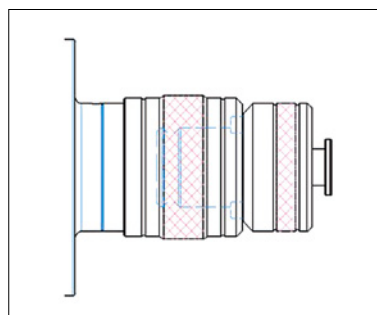
How to tighten

TCA insertion



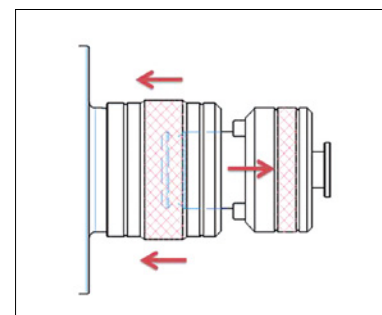
1. Insert TCA after pressing the tap holder cover down
2. Connect TCA to be aligned with the key groove and press it until the sound "click" is heard.

TCA mounting



1. The tap holder cover is put in the normal position.

TCA removal



1. Remove TCA after pressing the tap holder cover.

C This product does not support the internal coolant system.

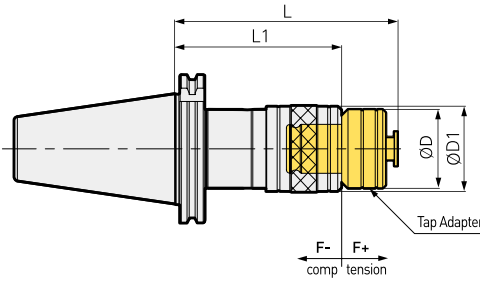
※ DTN12, DTN22 : Remove them by pulling the sliding ring down.

※ DTN38 : Remove it by pulling the adapter forward.



BT-DTN

Tapping holder



- For more information on the product features, see **102p**.
- For more information on the applicable adapter, see **105p**.

	Model No.	Tap size	L	L1	ØD	ØD1	Adapter used	F-	F+	Kg	Package weight (Kg)	
BT30	BT30-DTN12-85	M3~M12	85	60	32	39	TCA1-M	4	10	0.5	0.7	
	BT40-DTN12-90	M3~M12	90	65	32	39	TCA1-M	4	10	1.2	1.4	
BT40	BT40-DTN12-120	M3~M12	120	95	32	39	TCA1-M	4	10	1.5	1.7	
	BT40-DTN22-130	M8~M24	130	96	50	56	TCA2-M	12.5	12.5	1.7	1.9	
	BT40-DTN22-160	M8~M24	160	126	50	56	TCA2-M	12.5	12.5	2.2	2.4	
BT50	BT50-DTN12-100	M3~M12	100	75	32	39	TCA1-M	4	10	3.9	4.2	
	BT50-DTN12-130	M3~M12	130	105	32	39	TCA1-M	4	10	3.9	4.3	
	BT50-DTN22-140	M8~M24	140	106	50	56	TCA2-M	12.5	12.5	4.3	4.7	
	BT50-DTN22-170	M8~M24	170	136	50	56	TCA2-M	12.5	12.5	4.7	5.1	
	BT50-DTN38-185	M16~M38	185	140	72	81	TCA3-M	20	20	5.7	6.1	
	BT50-DTN38-215	M16~M38	215	170	72	81	TCA3-M	20	20	6.7	7.1	

C This product does not support the internal coolant system.

Chuck

Arbor / Modular

Boring tool

Angular head

cBN/PCD

Smart factory

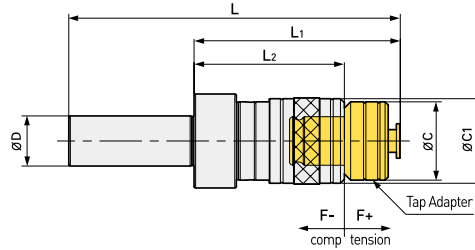
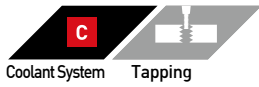
TAUMAX

OTHER



S-DTN

Straight shank tapping holder



- For more information on the product features, see **102p**.
- For more information on the TAP adapter (TCA), see **105p**.

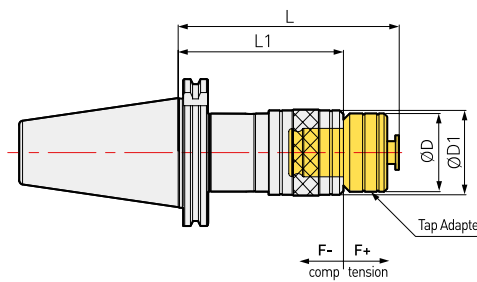
S32	Model No.	Tapping range	ØD	L	L1	L2	ØD	ØD1	F-	F+	Adapter used	Kg	Package weight (Kg)
	S32-DTN12-90	M3-M12	32	170	90	65	32	39	4	10	TCA1	1.0	1.1
	S32-DTN22-130	M8-M24	32	210	130	96	50	56	12.5	12.5	TCA2	1.8	1.9

C This product does not support the internal coolant system.



SK-DTN

Tapping holder



- For more information on the product features, see **102p**.
- For more information on the applicable adapter, see **105p**.

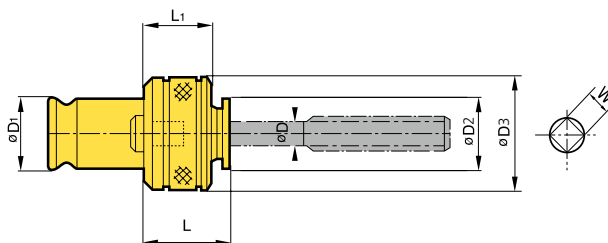
	Model No.	Tap size	L	L1	ØD	ØD1	Adapter used	F-	F+	Kg	Package weight (Kg)
SK40	SK40-DTN12-90	M3~M12	90	65	32	39	TCA1-M	4	10	1.0	1.2
	SK40-DTN22-130	M8~M22	130	96	50	56	TCA2-M	12.5	12.5	1.6	1.8
SK50	SK50-DTN12-100	M3~M12	100	75	32	39	TCA1-M	4	10	2.9	3.2
	SK50-DTN22-140	M8~M22	140	106	50	56	TCA2-M	12.5	12.5	3.5	3.9

C This product does not support the internal coolant system.



TCA

Tap adapter



※ JIS specifications customizable

	Model No.	ØD	ØD1	L	L1	ØD2	ØD3	W	Kg	Package weight(Kg)
TCA1	TCA1-M3	4	19	24	22	19	32	3.2	0.2	0.2
	TCA1-M4	5	19	24	22	19	32	4	0.2	0.2
	TCA1-M5	5.5	19	24	22	19	32	4	0.2	0.2
	TCA1-M6	6	19	24	22	19	32	4	0.2	0.2
	TCA1-M8	6.2	19	38	22	19	32	5	0.2	0.2
	TCA1-M10	7	19	38	22	19	32	5.5	0.2	0.2
	TCA1-M11	8	19	38	22	19	32	6	0.2	0.2
	TCA1-M12	8.5	19	38	22	19	32	6.5	0.2	0.2
TCA2	TCA2-M8	6.2	31	38	28	30	50	5	0.5	0.5
	TCA2-M10	7	31	38	28	30	50	5.5	0.5	0.5
	TCA2-M12	8.5	31	39	28	30	50	6.5	0.5	0.5
	TCA2-M14	10.5	31	41	28	30	50	8	0.5	0.5
	TCA2-P(=1/4)	11	31	31	28	30	50	9	0.5	0.5
	TCA2-M16	12.5	31	43	28	30	50	10	0.5	0.5
	TCA2-M18	14	31	44	28	30	50	11	0.5	0.5
	TCA2-M20	15	31	45	28	30	50	12	0.5	0.5
	TCA2-M22	17	31	46	28	30	50	13	0.5	0.5
	TCA2-P1/2	18	31	36	28	30	50	14	0.5	0.5
	TCA2-M24	19	31	46	28	30	50	15	0.5	0.5
	TCA3	TCA3-M16	12.5	48	35	37	47	72	10	1.4
TCA3-M18		14	48	36	37	47	72	11	1.4	1.6
TCA3-M20		15	48	37	37	47	72	12	1.4	1.6
TCA3-M22		17	48	38	37	47	72	13	1.4	1.6
TCA3-M24		19	48	44	37	47	72	15	1.4	1.6
TCA3-M27		20	48	62	37	47	72	15	1.4	1.6
TCA3-M30		23	48	62	37	47	72	17	1.4	1.6
TCA3-M33		25	48	66	37	47	72	19	1.4	1.6
TCA3-M36	28	48	68	37	47	72	21	1.4	1.6	

C This product does not support the internal coolant system.



DST PAT.

High speed synchro tapping chuck



G6.3 C Tapping
G value Coolant System Tapping

Features

- Tapping chuck for high speed machining
- Specially designed to absorb thrust load to provide tap damage prevention and a longer tool service life
- Internal coolant applicable
- Boring range : M1~M22

NAMING	BT40	DST	22	110
	Spindle	Tapping holder	Tapping Range	Length



Precise machining

Machining range expanded



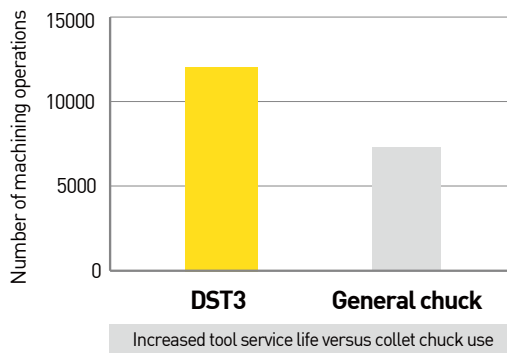
DST22
(V=100 m/min)

Improved thread quality



Conventional products

M1.4x0.3 service life test

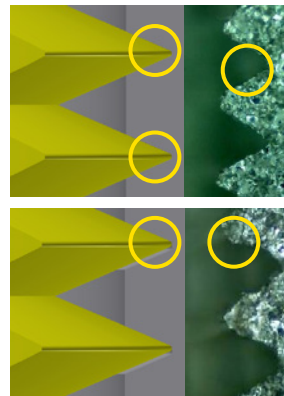
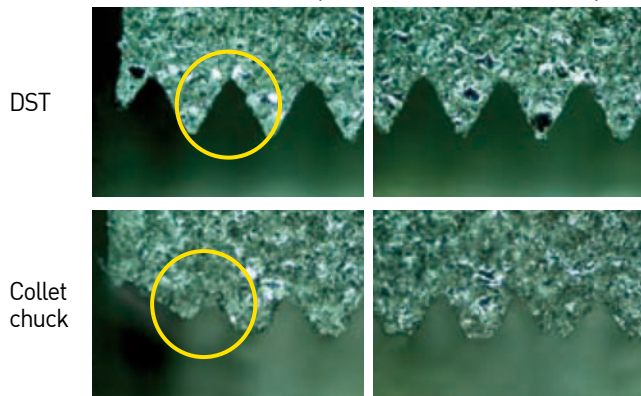


Tapping dedicated collet

- In the case of tapping, it is recommended to use TER collet.
- DST3 : ER11 collet used

Comparison of Thread shape

One-time introduction part One-time withdrawal part



Synchro tap chuck (DST3)

Clean thread shape without collapse

General collet chuck

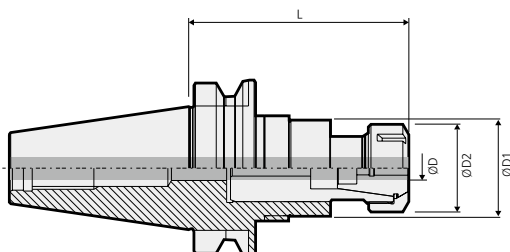
Collapsed thread due to no adjustment for synchro error

C Internal coolant system is optional.



BT-DST

High speed synchro tapping chuck



- For more information on the product features, see **106p**
- For more information on TER collet, see **109p**
- For more information on ER collet, see **80p**

	Model No.	ØD	L	ØD2	ØD1	Collet used	F-	F+	Kg	Package weight (Kg)
BT30	BT30-DST3-70	M1~M3	70	19	20	ER11	0.5	0.5	0.5	0.5
	BT30-DST10-100	M3~M10	100	28	40.4	TER16	0.5	0.5	0.8	0.9
BT40	BT40-DST3-70	M1~M3	70	19	20	ER11	0.5	0.5	1.0	1.1
	BT40-DST10-100	M3~M10	100	28	40.4	TER16	0.5	0.5	1.3	1.4
	BT40-DST22-110	M6~M22	110	49.5	60	TER32	0.7	0.7	1.7	2.0
BT50	BT50-DST10-110	M3~M10	110	49.5	60	TER16	0.5	0.5	3.8	4.1
	BT50-DST22-130	M6~M22	130	49.5	60	TER32	0.7	0.7	4.5	4.9

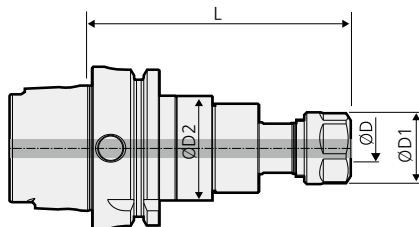
C Internal coolant system is optional.

Chuck
Arbor / Modular
Boring tool
Angular head
cBN/PCD
Smart factory
TAUMAX
OTHER



HSK-DST

HSK-DST



- For more information on the product features, see **106p**.
- For more information on TER collet, see **109p**.
- For more information on ER collet, see **80p**.

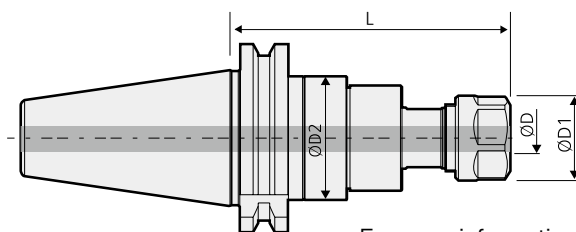
	Model No.	ØD	L	ØD1	ØD2	Collet used	F-	F+	Kg	Package weight (Kg)
HSK63A	HSK63A-DST3-80	M1~M3	80	19	20	ER11	0.5	0.5	0.7	0.8
	HSK63A-DST10-100	M3~M10	100	28	40.4	TER16	0.5	0.5	0.9	1.2
	HSK63A-DST22-130	M6~M22	130	49.5	60	TER32	0.7	0.7	1.8	2.0

C Internal coolant system is optional.



SK-DST

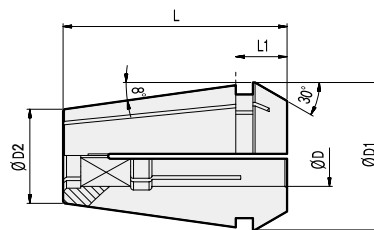
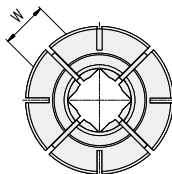
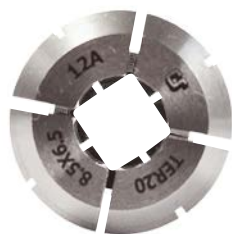
High speed synchro tapping chuck



- For more information on the product features, see **106p**.
- For more information on TER collet, see **109p**.
- For more information on ER collet, see **80p**.

	Model No.	ØD	L	ØD1	ØD2	Collet used	F-	F+	Kg	Package weight (Kg)
SK30	SK30-DST3-70	M1~M3	70	19	20	ER11	0.2	0.2	0.4	0.5
	SK40-DST3-70	M1~M3	70	19	20	ER11	0.2	0.2	0.9	1.0
SK40	SK40-DST10-110	M3~M10	110	28	35	TER16	0.5	0.5	1.2	1.4
	SK40-DST22-120	M6~M22	120	50	54	TER32	0.7	0.7	1.8	2.1
SK50	SK50-DST10-110	M3~M10	110	28	35	TER16	0.5	0.5	3.0	3.3
	SK50-DST22-120	M6~M22	120	50	54	TER32	0.7	0.7	3.7	4.1

C Internal coolant system is optional.



※ Waterproof type tapping is possible by using RTJW and RUT nuts (standard dimension only)

	Model No.	Tap applied	ØD	L	W	ØD1	ØD2	L1	Kg	Package weight (Kg)
TER16	TER16-4x3.2	M3	4	27.5	3.2	16.74	10.1	6.3	0.03	0.03
	TER16-5x4	M4	5	27.5	4	16.74	10.1	6.3	0.03	0.03
	TER16-5.5x4.5	M5	5.5	27.5	4.5	16.74	10.1	6.3	0.02	0.02
	TER16-6x4.5	M6,U1/4	6	27.5	4.5	16.74	10.1	6.3	0.02	0.02
	TER16-6.2x5	M7, M8	6.2	27.5	5	16.74	10.1	6.3	0.02	0.02
	TER16-7x5.5	M9, M10, U3/8	7	27.5	5.5	16.74	10.1	6.3	0.02	0.02
TER20	TER20-5x4	M4	5	31.5	4	20.74	13.2	7.2	0.05	0.05
	TER20-5.5x4.5	M5	5.5	31.5	4.5	20.74	13.2	7.2	0.05	0.05
	TER20-6x4.5	M6,U1/4	6	31.5	4.5	20.74	13.2	7.2	0.05	0.05
	TER20-6.2x5	M7, M8	6.2	31.5	5	20.74	13.2	7.2	0.04	0.04
	TER20-7x5.5	M9, M10, U3/8	7	31.5	5.5	20.74	13.2	7.2	0.05	0.05
	TER20-8x6	M11, U7/16, P1/8	8	31.5	6	20.74	13.2	7.2	0.04	0.04
	TER20-8.5x6.5	M12	8.5	31.5	6.5	20.74	13.2	7.2	0.04	0.04
TER25	TER25-5x4	M4	5	34	4	25.74	17.6	7.5	0.9	0.9
	TER25-5.5x4.5	M5	5.5	34	4.5	25.74	17.6	7.5	0.8	0.8
	TER25-6x4.5	M6	6	34	4.5	25.74	17.6	7.5	0.8	0.8
	TER25-6.2x5	M7, M8	6.2	34	5	25.74	17.6	7.5	0.1	0.1
	TER25-7x5.5	M9, M10, U3/8	7	34	5.5	25.74	17.6	7.5	0.8	0.8
	TER25-8.5x6.5	M12	8.5	34	6.5	25.74	17.6	7.5	0.8	0.8
TER32	TER32-6x4.5	M6,U1/4	6	40	4.5	32.74	23.1	8.2	0.2	0.2
	TER32-6.2x5	M7, M8	6.2	40	5	32.74	23.1	8.2	0.2	0.2
	TER32-7x5.5	M9, M10, U3/8	7	40	5.5	32.74	23.1	8.2	0.2	0.2
	TER32-8x6	M11, U7/16, P1/8	8	40	6	32.74	23.1	8.2	0.2	0.2
	TER32-8.5x6.5	M12	8.5	40	6.5	32.74	23.1	8.2	0.2	0.2
	TER32-10.5x8	M14, U9/16	10.5	40	8	32.74	23.1	8.2	0.2	0.2
	TER32-12.5x10	M16	12.5	40	10	32.74	23.1	8.2	0.2	0.2
	TER32-14x11	M18, P3/8	14	40	11	32.74	23.1	8.2	0.1	0.1
	TER32-15x12	M20	15	40	12	32.74	23.1	8.2	0.1	0.1
	TER32-17x13	M22, U7/8	17	40	13	32.74	23.1	8.2	0.1	0.1
	TER32-11x9	P1/4	11	40	9	32.74	23.1	8.2	0.2	0.2
	TER32-12x9	U5/8	12	40	9	32.74	23.1	8.2	0.2	0.2
	TER32-9x7	U1/2	9	40	7	32.74	23.1	8.2	0.2	0.2

Chuck

Arbor / Modular

Boring tool

Angular head

cBN/PCD

Smart factory

TAUMAX

OTHER



OFH

Floating holder for brush



G6.3	15,000	2~8N	C	
G value	Max RPM	Load	Coolant System	Deburring

Features

- Can be used consistently as a dedicated arbor (floating function) with steady pressure
- G6.3, Max RPM 15,000rpm
- Provides a longer brush service life (about 50% increase versus collet chuck)
- Reduces lead time and improves productivity
- Various sizes of sleeves and brushes can be used

NAMING

BT30	—	OFH	—	6	—	75
Spindle		Floating holder for brush		Brush Dia.		Length

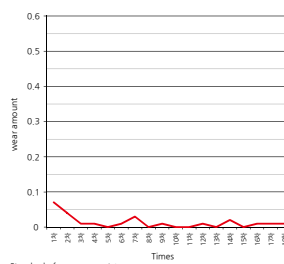


Integral exclusive tool



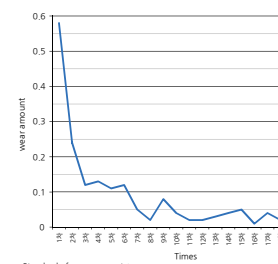
Comparison of brush wear performance

OFH Floating Holder



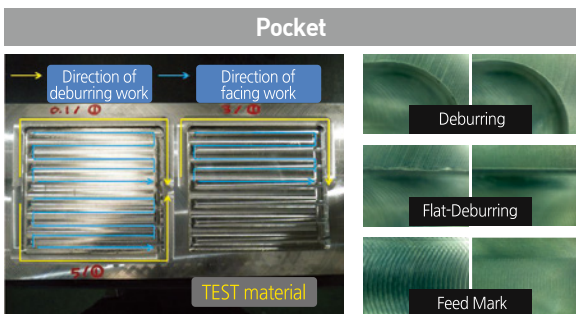
Can be used consistently due to a steady wear loss

General Collet Chuck



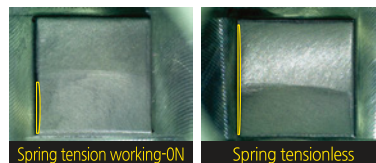
Brush service life shortened due to an abrupt wear loss

Deburring after cutting aluminium

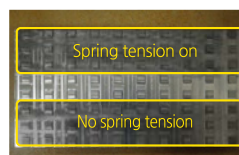


Surface roughness improved about 4 times
 $0.906\mu\text{m}$ (before application) \rightarrow $0.179\mu\text{m}$ (after application)

Boss



Workpiece defect wear area **reduced about 2.5-times**

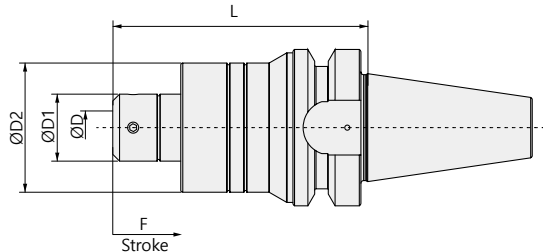
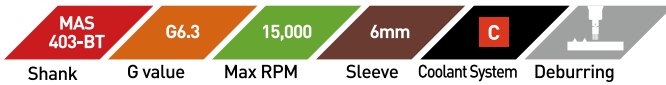


Brush wear loss **reduced about 3 times**
 (*based on the entire area applied wear loss)
 \Rightarrow (Total wear loss) 0.18mm
 \Rightarrow (Total wear loss) 0.59mm



BT-OFH

Floating holder for brush



• For more information on the product features, see [1106p](#).

Model No.	Sleeve Dia. (ØD)	L	ØD1	ØD2	ØD3	L1	L2	Sleeve stroke(F)	RPM
BT30-OFH6-75	6	75	19.7	38	6	0.7	0.8	6	15,000

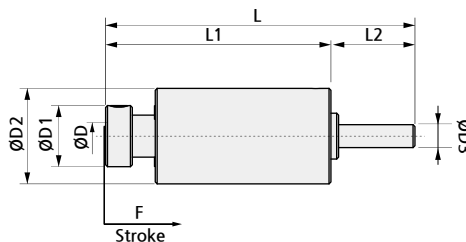
BT30

C This product does not support the internal coolant system.



ST-OFH

Floating holder for brush



• For more information on the product features, see [1106p](#).

Model No.	Sleeve Dia. (ØD)	L	ØD1	ØD2	ØD3	L1	L2	Sleeve stroke(F)	RPM
ST06-OFH6-60	6	81	16	25	6	59	20	6	15,000

ST06

C This product does not support the internal coolant system.

Chuck

Arbor / Modular

Boring tool

Angular head

cBN/PCD

Smart factory

TAUMAX

OTHER



Arbor Modular

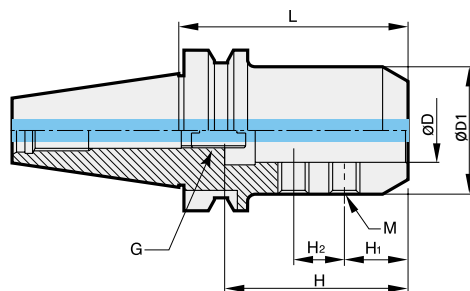
DINOX NC TOOLING SYSTEM

SLA	114
MTA	118
FMA	119
FMC	122
MD	126
EXT	130
RDC	130



BT-SLA

Side lock arbor



• For more information on the related parts, see **117p**

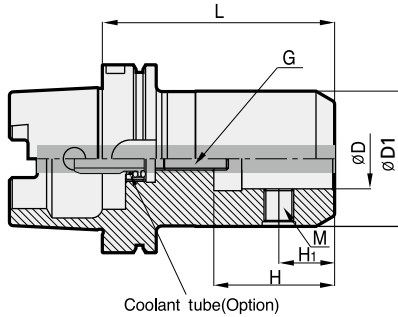
	Model No.	ØD	L	ØD1	H	H1	H2	M	G	Kg	Package weight (Kg)
BT30	BT30-SLA16-90	16	90	40	72	25	20	M10	M12	0.9	1.0
	BT30-SLA20-90	20	90	50	72	25	20	M12	M12	1.2	1.3
	BT30-SLA25-90	25	90	50	72	25	20	M12	M12	1.1	1.2
BT40	BT40-SLA16-90	16	90	40	72	25	20	M10	M12	1.4	1.6
	BT40-SLA20-90	20	90	50	72	25	20	M12	M12	1.8	2.0
	BT40-SLA25-90	25	90	50	72	25	20	M12	M12	1.6	1.8
	BT40-SLA32-90	32	90	60	82	25	25	M14	M12	1.8	2.0
	BT40-SLA32-105	32	105	60	82	25	25	M14	M12	2.0	2.3
	BT40-SLA40-105	40	105	80	82	25	25	M16	M12	2.9	3.1
BT50	BT50-SLA20-105	20	105	50	72	25	20	M12	M12	4.4	4.7
	BT50-SLA25-105	25	105	50	72	25	20	M12	M12	4.3	4.6
	BT50-SLA32-105	32	105	60	82	25	25	M14	M12	4.5	4.8
	BT50-SLA40-105	40	105	90	82	25	20	M16	M12	6.1	6.4
	BT50-SLA42-105	42	105	90	82	25	25	M16	M12	5.9	6.2

C Internal coolant system installed.



HSK-SLA

Side lock arbor



• For more information on the related parts, see **117p**

	Model No.	ØD	L	ØD1	H	H1	M	G	Kg	Package weight (Kg)
HSK63A	HSK63A-SLA20-100	20	100	52	51	25	M8	M12	1.6	1.8
	HSK63A-SLA25-105	25	105	65	59	25	M8	M12	2.1	2.4
	HSK63A-SLA32-105	32	105	72	63	30	M5	M12	2.3	2.6
HSK100A	HSK100A-SLA20-105	20	105	52	51	25	M16	M12	3.1	3.4
	HSK100A-SLA25-110	25	110	65	59	25	M18	M12	3.8	4.0
	HSK100A-SLA32-125	32	125	72	63	30	M20	M12	4.4	4.8

C Internal coolant system is optional.

For separate purchase



Classification by shank	
HSK50	HSK50A-CNS
HSK63	HSK63A-CNS
HSK100	HSK100A-CNS



SK-SLA

Side lock arbor



DIN69871
-1A/B
C
 Milling
 Drilling

Shank Coolant System Milling Drilling

Fig.1

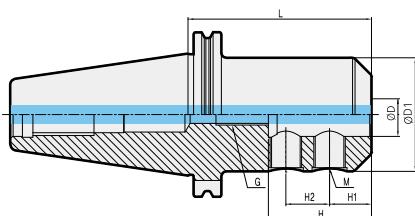
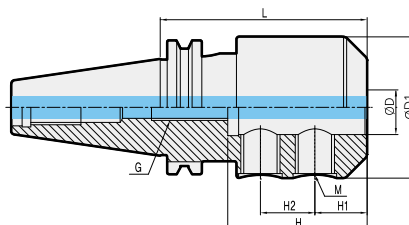


Fig.2



• For more information on the related parts, see **117p**

	Model No.	ØD	L	ØD1	H	H1	H2	M	G	Fig.	Kg	Package weight (Kg)
SK40	SK40-SLA16-75	16	75	48	49	24	-	M14	M12	-	1.4	1.6
	SK40-SLA20-75	20	75	52	51	25	-	M16	M12	-	1.5	1.7
	SK40-SLA25-95	25	95	65	59	24	25	M18	M12	2	2.1	2.4
	SK40-SLA32-105	32	105	72	63	24	28	M20	M12	2	2.8	2.9
SK50	SK50-SLA16-90	16	90	48	49	24	-	M14	M12	-	3.5	3.8
	SK50-SLA20-90	20	90	52	51	25	-	M16	M12	-	3.6	3.9
	SK50-SLA25-105	25	105	65	59	24	25	M18	M12	1	4.5	4.8
	SK50-SLA32-120	32	120	72	63	24	28	M20	M12	1	5.2	5.6
	SK50-SLA40-120	40	120	80	73	30	32	M20	M12	1	5.6	5.6

C Internal coolant system installed.





SLA SPARE PART

Side lock arbor related parts




Main components

Spare Part		Main components		
Type		Set screw		Adjust screw
Images				
		Model No.	BT type	
	SLA16	BTF1010	BTF1414 - 1.5	M1230C
	SLA20	BTF1212-1.5	BTF1616 - 1.5	M1230C
	SLA25	BTF1212-1.5	BTF1818 - 1.5	M1230C
	SLA32	BTF1414-1.5	BTF2020 - 1.5	M1230C
	SLA40	BTF1624-1.5	BTF2020 - 1.5	M1230C
	SLA42	BTF1624-1.5	BTF2020 - 1.5	M1230C

※ In the case of HSK types, adjustment screws may be different.

For separate purchase

Spare Part		For separate purchase		
Type		Wrench		
Images				
		Model No.	BT type	HSK / SK type
	SLA16	LW - 5	LW - 6	
	SLA20	LW - 6	LW - 8	
	SLA25	LW - 6	LW - 8	
	SLA32	LW - 6	LW - 10	
	SLA40	LW - 8	LW - 10	
	SLA42	LW - 8	LW - 10	



SK-MTA

Morse taper arbor



DIN69871
-1A/B

C

Shank

Coolant System

Milling

Drilling

Reaming

Fig.1

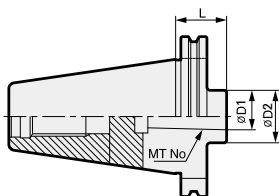
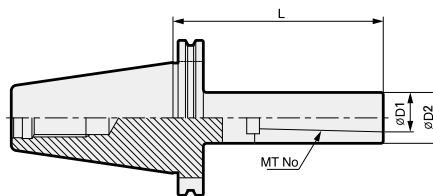


Fig.2



- Holder for Morse taper shank tools (drill, reamer)

Model No.	MT No.	L	ØD1	ØD2	Kg	Fig.	Kg	Package weight [Kg]
SK50-MTA3-45	3	45	23.825	40	3.8	1	2.7	3.0
SK50-MTA3-150	3	150	23.825	40	4.6	2	3.6	4.0
SK50-MTA4-75	4	75	31.267	50	3.9	1	2.9	3.2

SK50

C This product does not support the internal coolant system.





BT-FMA

Face mill arbor



Fig.1

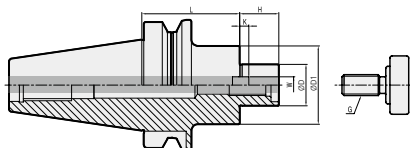


Fig.2

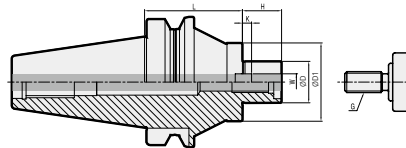


Fig.3

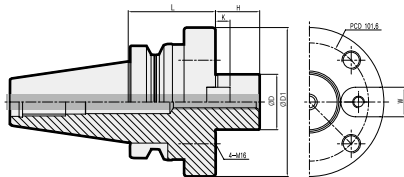
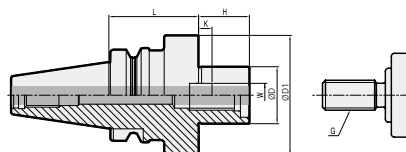


Fig.4



※ The relevant weight excludes the weight of the face cutter.

• For more information on the related parts, see **121p**

	Model No.	Cutter diameter	ØD	ØD1	L	H	W	K	G	Fig.	Kg	Package weight (Kg)
BT30	BT30-FMA25.4-45	80	25.4	50	45	22	9.5	5	M12	4	1.0	1.0
	BT40-FMA25.4-45	80	25.4	50	45	22	9.5	5	M12	1	1.4	1.6
BT40	BT40-FMA25.4-90	80	25.4	50	90	22	9.5	5	M12	1	2.2	2.4
	BT40-FMA31.75-45	100	31.75	60	45	30	12.7	7	M16	1	1.6	1.8
	BT40-FMA31.75-90	100	31.75	60	90	30	12.7	7	M16	1	2.5	2.7
	BT40-FMA38.1-60	125	38.1	80	60	34	15.87	9	M20	4	2.6	2.8
BT50	BT50-FMA25.4-45	80	25.4	50	45	22	9.5	5	M12	1	4.0	4.3
	BT50-FMA25.4-90	80	25.4	50	90	22	9.5	5	M12	1	4.7	5.0
	BT50-FMA25.4-150	80	25.4	50	150	22	9.5	5	M12	2	6.4	6.8
	BT50-FMA31.75-45	100	31.75	60	45	30	12.7	7	M16	1	4.1	4.4
	BT50-FMA31.75-75	100	31.75	60	75	30	12.7	7	M16	1	4.8	5.1
	BT50-FMA31.75-105	100	31.75	60	105	30	12.7	7	M16	2	5.6	5.9
	BT50-FMA38.1-45	125	38.1	80	45	34	15.87	9	M20	1	4.4	4.7
	BT50-FMA38.1-75	125	38.1	80	75	34	15.87	9	M20	1	5.6	5.9
	BT50-FMA50.8-45	160	50.8	100	45	36	19.05	10	M24	1	4.9	5.2
	BT50-FMA50.8-75	160	50.8	100	75	36	19.05	10	M24	1	6.8	7.1
	BT50-FMA47.625-75	200	47.625	128	75	38	25.4	12.5	-	3	8.3	8.6

C Internal coolant system is optional.



NT-FMA

Face mill arbor



Fig.1

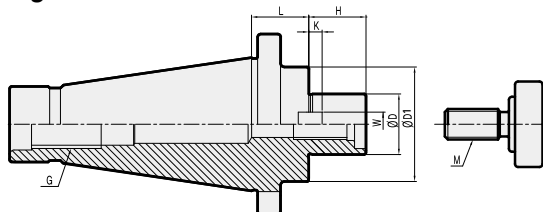
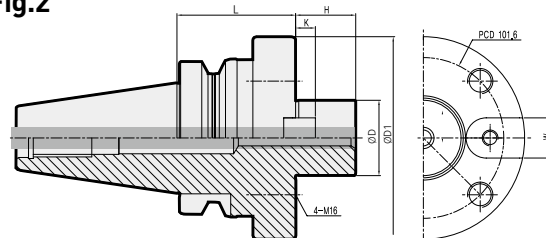


Fig.2



※ The relevant weight excludes the weight of the face cutter.

• For more information on the related parts, see **121p**

	Model No.	Cutter diameter	ØD	L	ØD1	H	M	W	K	G	Fig.	Kg	Package weight (Kg)
NT40	NT40-FMA25.4-25	80	25.4	25	50	22	M12	9.5	5	M16	1	1.1	-
	NT40-FMA31.75-25	100	31.75	25	60	30	M16	12.7	7	M16	1	1.3	1.5
	NT40-FMA38.1-25	125	38.1	25	80	34	M20	15.87	9	M16	1	1.8	2.0
	NT40U-FMA50.8-25	160	50.8	25	100	36	M24	19.05	10	M16	1	2.8	3.0
NT50	NT50-FMA25.4-25	80	25.4	23.2	50	22	M12	9.5	5	M24	1	3.1	3.4
	NT50-FMA31.75-30	100	31.75	26.2	60	30	M16	12.7	7	M24	1	3.3	3.6
	NT50-FMA38.1-30	125	38.1	25.2	80	34	M20	15.87	9	M24	1	3.6	3.9
	NT50-FMA50.8-30	160	50.8	27.2	100	36	M24	19.05	10	M24	1	4.2	4.5
	NT50-FMA47.625-25	200	47.625	27.2	128	38	-	25.4	12.5	M24	2	5.3	5.6

C This product does not support the internal coolant system.







FMA SPARE PART


Face mill arbor related parts



Main components

Spare Part		Main components			
Type	Key	Key bolt	Mount bolt	Clamp bolt	
Images					
Model No.					
FMA25.4	K9.5	BX0412	MBA-M12	BX1230	
FMA31.75	K12.7	BX0515	MBA-M16	-	
FMA38.1	K15.87	BX0616	MBA-M20	-	
FMA50.8	K19.05	BX0820	MBA-M24	-	
FMA47.625	K25.4	BX1020		BX1645	

For separate purchase

Spare Part		For separate purchase	
Type		Wrench	
Images			
Model No.			
FMA25.4			LW-10
FMA31.75			LW-14
FMA38.1			LW-17

Chuck

Arbor / Modular

Boring tool

Angular head

cBN/PCD

Smart factory

TAUMAX

OTHER



BT-FMC

Facemill arbor



Fig.1

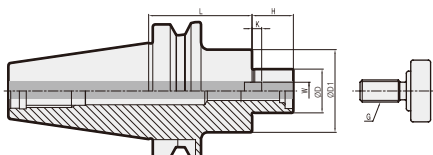


Fig.2

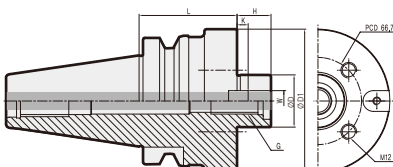
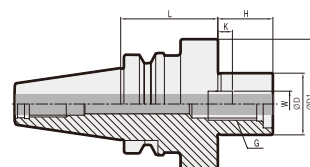


Fig.3



※ The relevant weight excludes the weight of the face cutter.

• For more information on the related parts, see **125p**

	Model No.	Cutter diameter	ØD	ØD1	L	H	W	K	G	Fig.	Kg	Package weight (Kg)
BT30	BT30-FMC16-45	40	16	38	45	17	8	5.0	M8	1	0.7	0.7
	BT30-FMC22-45	50/63	22	48	45	19	10	5.6	M10	2	0.8	0.9
	BT30-FMC27-50	80	27	60	50	21	12	6.3	M12	2	1.0	1.1
BT40	BT40-FMC16-60	40	16	38	60	17	8	5.0	M8	1	1.3	1.5
	BT40-FMC22-45	50/63	22	48	45	19	10	5.6	M10	1	1.3	1.5
	BT40-FMC22-90	50/63	22	48	90	19	10	5.6	M10	1	1.9	2.1
	BT40-FMC27-60	80	27	60	60	21	12	6.3	M12	1	1.8	2.0
	BT40-FMC27-90	80	27	60	90	21	12	6.3	M12	1	2.4	2.6
	BT40-FMC32-60	100	32	78	60	24	14	7.0	M16	2	2.1	2.3
BT50	BT40-FMC40-50	125/160	40	89	50	27	15.87	8.0	M20	3	2.3	2.5
	BT50-FMC16-60	40	16	38	60	17	8	5.0	M8	1	3.9	4.2
	BT50-FMC22-60	50/63	22	48	60	19	10	5.6	M10	1	4.1	4.4
	BT50-FMC27-40	80	27	60	40	21	12	6.3	M12	1	3.8	4.1
	BT50-FMC27-90	80	27	60	90	21	12	6.3	M12	1	4.8	5.1
	BT50-FMC27-150	80	27	60	150	21	12	6.3	M12	1	6.1	6.5
	BT50-FMC32-45	100	32	78	45	24	14	7.0	M16	1	4.1	4.4
	BT50-FMC32-75	100	32	78	75	24	14	7.0	M16	1	5.2	5.5
	BT50-FMC32-105	100	32	78	105	24	14	7.0	M16	1	6.3	6.6
	BT50-FMC40-50	125/160	40	89	50	27	15.87	8.0	M20	2	4.6	4.9

☐ Internal coolant system is optional.



HSK-FMC

Face mill arbor



Fig.1

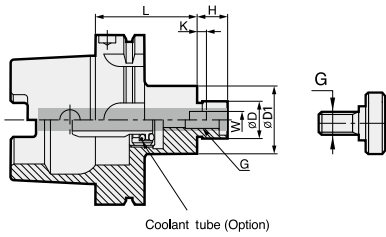


Fig.2

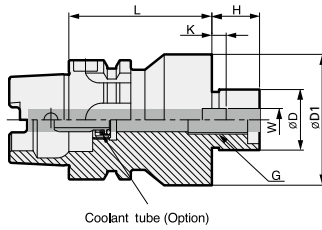
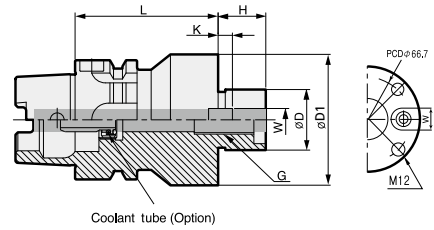


Fig.3



※ The relevant weight excludes the weight of the face cutter.

• For more information on the related parts, see **125p**

	Model No.	Cutter diameter	ØD	ØD1	L	H	W	K	G	Fig.	Kg	Package weight (Kg)
HSK50A	HSK50A-FMC16-40	40	16	38	40	17	8	5	M8	1	0.4	0.7
	HSK50A-FMC22-50	50/63	22	48	50	19	10	5.6	M10	1	0.8	0.9
	HSK63A-FMC16-50	40	16	38	50	17	8	5.0	M8	1	0.9	1.1
	HSK63A-FMC22-50	50/63	22	48	50	19	10	5.6	M10	1	1.1	1.3
	HSK63A-FMC27-60	80	27	60	60	21	12	6.3	M12	1	1.4	1.6
	HSK63A-FMC32-60	100	32	78	60	24	14	7.0	M16	2	1.7	1.9
	HSK63A-FMC40-60	125/160	40	89	60	27	15.87	8.0	M20	3	2.5	2.6
HSK63A												

☐ Internal coolant system is optional.



SK-FMC

Facemill arbor



Fig.1

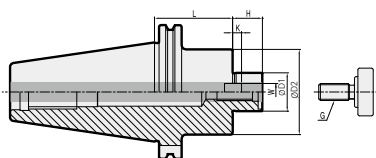


Fig.2

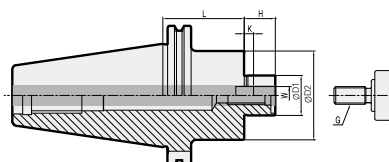
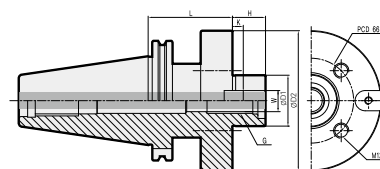


Fig.3



※ The relevant weight excludes the weight of the face cutter.

• For more information on the related parts, see **125p**

	Model No.	Cutter diameter	ØD1	L	ØD2	H	W	K	G	Fig.	Kg	Package weight (Kg)
SK30	SK30-FMC16-60	40	16	60	38	17	8	5.0	M8	1	0.8	0.8
	SK30-FMC22-50	50/63	22	50	48	19	10	5.6	M10	2	0.8	0.9
	SK30-FMC27-55	80	27	55	60	21	12	6.3	M12	2	1.1	1.2
SK40	SK40-FMC16-55	40	16	55	38	17	8	5.0	M8	1	1.2	1.4
	SK40-FMC22-55	50/63	22	55	48	19	10	5.6	M10	1	1.4	1.6
	SK40-FMC27-60	80	27	60	60	21	12	6.3	M12	2	1.6	1.8
	SK40-FMC32-60	100	32	60	78	24	14	7.0	M16	2	2.2	2.4
	SK40-FMC40-50	125/160	40	50	89	27	15.87	8.0	M20	3	2.3	2.5
SK50	SK50-FMC16-60	40	16	60	38	17	8	5.0	M8	1	2.9	3.2
	SK50-FMC22-60	50/63	22	60	48	19	10	5.6	M10	1	3.2	3.5
	SK50-FMC27-40	80	27	40	60	21	12	6.3	M12	1	3.2	3.5
	SK50-FMC32-45	100	32	45	78	24	14	7.0	M16	1	3.7	4.0
	SK50-FMC40-50	125/160	40	50	89	27	15.87	8.0	M20	3	4.2	4.5

C Internal coolant system is optional.







FMC SPARE PART

Face mill arbor related parts



Main components

Spare Part		Main components			
Type	Key	Key bolt	Mount bolt	Clamp bolt	
Images					
Model No.					
FMC16	K8.0	BX0310	-	BX0830	
FMC22	K10.0	BX0412	-	BX1030	
FMC27	K12.0	BX0516	MBA-M12	BX1230	
FMC32	K14.0	BX0616	MBA-M16	-	
FMC40	K15.87	BX0616	MBA-M20	BX1230	

※ BX1235 clamp bolts are used for SK40-FMC40-50.

For separate purchase

Spare Part		For separate purchase
Type	Images	Wrench
Model No.		
FMC16		LW-6
FMC22		LW-8
FMC27		LW-10
FMC32		LW-14
FMC40		LW-17

Chuck

Arbor / Modular

Boring tool

Angular head

cBN/PCD

Smart factory

TAUMAX

OTHER



BT-MD

Modular arbor



MAS
403-BT
G6.3
C

Shank G value Coolant System

Fig.1

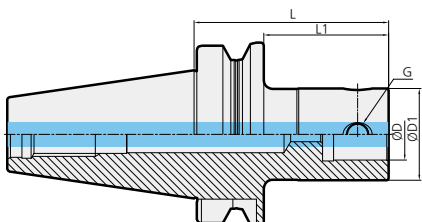
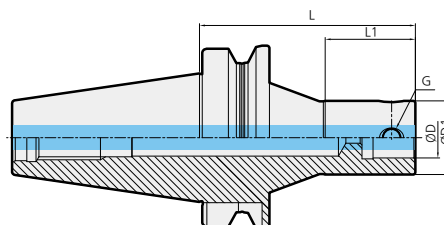


Fig.2



• For more information on the related parts, see **131p**.

	Model No.	ØD	ØD1	L	L1	G	Fig.	Kg	Package weight (Kg)
BT30	BT30-MD19F-70	11	19	70	45	M5	1	0.5	0.5
	BT30-MD25F-90	14	25	90	63	M6	1	0.6	0.7
	BT30-MD32F-80	18	32	80	55	M8	1	0.7	0.7
	BT30-MD40F-45	22	40	45	22	M10	1	0.5	0.6
	BT30-MD40F-60	22	40	60	36	M10	1	0.7	0.7
	BT30-MD40F-80	22	40	80	56	M10	1	0.9	0.9
	BT30-MD50F-70	28	50	70	48	M12	1	0.9	1.0
BT40	BT40-MD19F-70	11	19	70	40	M5	1	1.0	1.2
	BT40-MD25F-95	14	25	95	63	M6	1	1.1	1.3
	BT40-MD25F-105R	14	25	105	40	M6	2	1.2	1.4
	BT40-MD32F-100	18	32	100	70	M8	1	1.2	1.5
	BT40-MD32F-115R	18	32	115	45	M8	2	1.5	1.8
	BT40-MD40F-60	22	40	60	31	M10	1	1.1	1.3
	BT40-MD40F-110R	22	40	110	60	M10	2	1.6	1.9
	BT40-MD40F-115	22	40	115	83	M10	1	1.6	1.8
	BT40-MD50F-105	28	50	105	73	M12	1	1.8	2.1
	BT40-MD63F-64	36	63	64	37	M16	1	1.5	1.7
	BT40-MD63F-110	36	63	110	83	M16	1	2.4	2.6
	BT40-MD63F-135	36	63	135	108	M16	1	3.0	3.3
	BT40-MD80F-100	45	80	100	73	M16	1	2.9	3.1

C Internal coolant system installed.



BT-MD

Modular arbor



MAS 403-BT G6.3 C
 Shank G value Coolant System

Fig.1

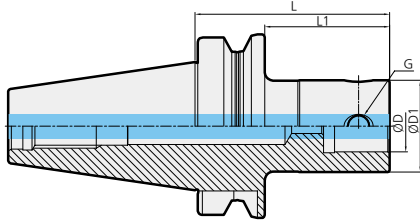
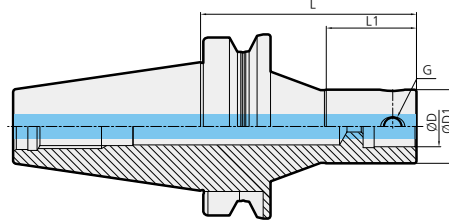


Fig.2



• For more information on the related parts, see **131p**

Model No.	ØD	ØD1	L	L1	G	Fig.	Kg	Package weight (Kg)
BT50-MD19F-85	11	19	85	44	M5	1	3.7	4.0
BT50-MD25F-105	14	25	105	62	M6	1	3.8	4.1
BT50-MD25F-120R	14	25	120	40	M6	2	3.8	4.1
BT50-MD32F-110	18	32	110	67	M8	1	4.0	4.3
BT50-MD32F-115R	18	32	115	45	M8	2	4.1	4.5
BT50-MD32F-235R	18	32	235	115	M8	2	5.5	5.9
BT50-MD40F-60	22	40	60	22	M10	1	3.7	4.0
BT50-MD40F-195	22	40	195	152	M10	1	4.8	5.2
BT50-MD40F-230R	22	40	230	180	M10	2	5.0	5.4
BT50-MD50F-125	28	50	125	82	M12	1	4.6	5.0
BT50-MD50F-225	28	50	225	182	M12	1	6.0	6.4
BT50-MD50F-250R	28	50	250	81	M12	2	7.0	7.4
BT50-MD63F-75	36	63	75	35	M16	1	4.2	4.5
BT50-MD63F-130	36	63	130	87	M16	1	5.3	5.7
BT50-MD63F-195	36	63	195	152	M16	1	6.8	7.2
BT50-MD63F-230	36	63	230	187	M16	1	7.5	7.9
BT50-MD80F-75	45	80	75	36	M16	1	4.3	4.6
BT50-MD80F-110	45	80	110	69	M16	1	5.7	6.0
BT50-MD80F-175	45	80	175	134	M16	1	8.0	8.4
BT50-MD90F-75	45	90	75	34	M16	1	4.8	5.1
BT50-MD90F-145	45	90	145	104	M16	1	7.4	7.8
BT50-MD90F-195	45	90	195	154	M16	1	9.4	9.8

C Internal coolant system installed.

Chuck

Arbor / Modular

Boring tool

Angular head

cBN/PCD

Smart factory

TAUMAX

OTHER



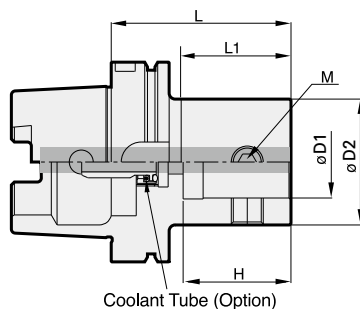
HSK-MD

Modular arbor



DIN69871
-1A/B
G6.3
C

Shank G value Coolant System



• For more information on the related parts, see **131p**.

Model No.	ØD1	L	ØD2	L1	H	M	Kg	Package weight (Kg)
HSK63A-MD19F-60	11	60	19	31	15.5	M5	0.7	0.9
HSK63A-MD25F-60	14	60	25	31	18.5	M6	0.7	0.9
HSK63A-MD32F-65	18	65	32	36	23.5	M8	0.8	1.0
HSK63A-MD40F-70	22	70	40	41	29	M10	0.9	1.1
HSK63A-MD50F-85	28	85	50	58	36	M12	1.3	1.5
HSK63A-MD63F-95	36	95	63	69	46	M16	1.7	1.9

C Internal coolant system is optional.

For separate purchase

Internal coolant system

Classification by shank	
HSK50	HSK50A-CNS
HSK63	HSK63A-CNS
HSK100	HSK100A-CNS



SK-MD

Modular arbor



DIN69871
-1A/B
G6.3
C

Shank G value Coolant System

Fig.1

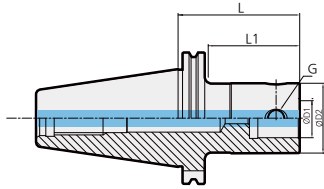


Fig.2

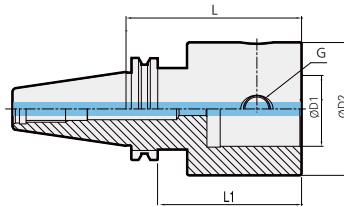
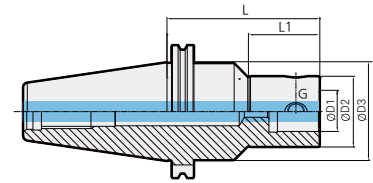


Fig.3



• For more information on the related parts, see **131p**

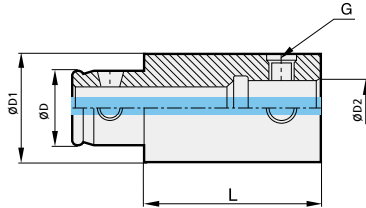
	Model No.	ØD1	L	ØD2	ØD3	L1	G	Fig.	Kg	Package weight (Kg)
SK40	SK40-MD19F-80R	11	80	19	30	12	M5	3	1.0	1.2
	SK40-MD25F-80R	14	80	25	35	22	M6	3	1.1	1.3
	SK40-MD32F-115R	18	115	32	42	36	M8	3	1.5	1.7
	SK40-MD40F-60	22	60	40	-	40	M10	1	1.1	1.3
	SK40-MD40F-100	22	100	40	-	80	M10	1	1.4	1.6
	SK40-MD50F-75	28	75	50	-	55	M10	1	1.5	1.7
	SK40-MD50F-100	28	100	50	-	80	M12	1	1.8	2.0
	SK40-MD63F-70	36	70	63	-	50	M16	2	1.4	1.6
SK50	SK50-MD19F-85R	11	85	19	40	12	M5	3	3.0	3.3
	SK50-MD25F-80R	14	80	25	44	22	M6	3	3.1	3.4
	SK50-MD25F-105R	14	105	25	44	22	M6	3	3.3	3.6
	SK50-MD32F-110	18	110	32	-	87	M8	1	3.0	3.3
	SK50-MD32F-110R	18	110	32	50	36	M8	3	3.5	3.8
	SK50-MD40F-100	22	100	40	-	75	M10	1	3.2	3.5
	SK50-MD40F-145	22	145	40	-	120	M10	1	3.5	3.9
	SK50-MD40F-220R	22	220	40	60	83	M10	3	5.6	6.0
	SK50-MD50F-125R	28	125	50	65	60	M12	3	4.3	4.6
	SK50-MD50F-240R	28	240	50	65	125	M12	3	6.6	7.0
	SK50-MD63F-75	36	75	63	-	52	M16	1	3.6	3.9
	SK50-MD63F-130	36	130	63	-	107	M16	1	4.7	5.1
	SK50-MD63F-230R	36	230	63	80	149	M16	3	7.9	8.3
	SK50-MD80F-95	45	95	80	-	75	M16	1	4.8	5.1
	SK50-MD80F-150	45	150	80	-	130	M16	1	6.8	7.2
	SK50-MD90F-115	45	115	90	-	95	M16	2	6.3	6.6
	SK50-MD90F-165	45	165	90	-	145	M16	2	8.1	8.5

C Internal coolant system installed.



EXT

Extension bar



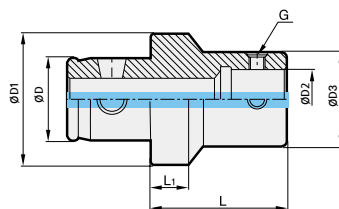
Model No.	ØD	ØD1	L	ØD2	G	Kg	Package weight (Kg)
EXT1930F	11	19	30	11	M5	0.1	0.1
EXT1950F	11	19	50	11	M5	0.1	0.1
EXT2530F	14	25	30	14	M6	0.1	0.1
EXT2550F	14	25	50	14	M6	0.2	0.2
EXT3235F	18	32	35	18	M8	0.2	0.2
EXT3260F	18	32	60	18	M8	0.4	0.4
EXT4040F	22	40	40	22	M10	0.4	0.4
EXT4090F	22	40	90	22	M10	0.9	0.9
EXT5050F	28	50	50	28	M12	0.7	0.7
EXT50100F	28	50	100	28	M12	1.4	1.5
EXT6360F	36	63	60	36	M16	1.4	1.5
EXT63120F	36	63	120	36	M16	2.9	2.9
EXT8070F	45	80	70	45	M16	2.5	2.7
EXT80120F	45	80	120	45	M16	4.5	4.7
EXT9080F	45	90	80	45	M16	3.8	4.0
EXT90130F	45	90	130	45	M16	6.4	6.6

C Internal coolant system installed.



RDC

Reducer bar




Model No.	ØD	ØD1	L	ØD2	ØD3	L1	G	Kg	Package weight (Kg)
RDC3225F	18	32	30	14	25	9	M6	0.1	0.2
RDC4025F	22	40	30	14	25	9	M6	0.3	0.3
RDC4032F	22	40	30	18	32	9	M8	0.2	0.2
RDC5025F	28	50	30	14	25	9	M6	0.3	0.4
RDC5032F	28	50	40	18	32	9	M8	0.3	0.4
RDC5040F	28	50	40	22	40	10	M10	0.5	0.6
RDC6325F	36	63	30	14	25	9	M6	0.6	0.7
RDC6332F	36	63	40	18	32	9	M8	0.6	0.7
RDC6340F	36	63	40	22	40	10	M10	0.7	0.8
RDC6350F	36	63	45	28	50	10	M12	0.9	1.0
RDC8040F	45	80	40	22	40	10	M10	1.2	1.4
RDC8050F	45	80	45	28	50	10	M12	1.3	1.5
RDC8063F	45	80	50	36	63	13	M16	1.6	1.8

C Internal coolant system installed.



Main components

Spare Part		Main components	
Type		Taper screw	
Model No.	Images		
MD19F		BTT0506F	
MD25F		BTT0608F	
MD32F		BTT0810F	
MD40F		BTT1013F	
MD50F		BTT1215F	
MD63F		BTT1620F	
MD80F		BTT1626F	
MD90F		BTT1631F	

For separate purchase

Spare Part		For separate purchase	
		Coolant tube	Wrench
			
		Classification by shank	
HSK50		HSK50A-CNS	LW-2.5
HSK63		HSK63A-CNS	LW-3
HSK100		HSK100A-CNS	LW-4
			LW-5
			LW-6
			LW-8
			LW-8
			LW-8



Boring tool

DINOX NC TOOLING SYSTEM

FBH/B	134
DBCA	144
DBC	155
TBCA	160
TBC	166
FBC	171
SMB	176
KMB	178
SMH	180
BB BITE	184
BH	185
BSA	186
BKA	188
FZ UNIT	190
BCF	192
FF	194



FBH/B

FBH Back boring & balanced type



G6.3 **C**

G value Coolant System Boring

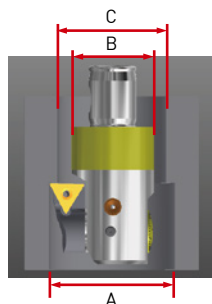
Features

- High-speed boring and back boring applicable
- High-precision balanced boring: G6.3
- Minimum adjustment range: 2 μ m

NAMING	FBH	32	33	B
	Fine boring head	MD Arbor Size	Boring Range(Min)	Balance type



Back boring range calculation



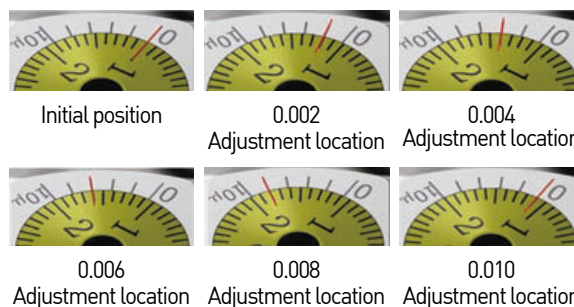
Model No.	Min. diameter for pass(\emptyset)'C'
FBH1920B	$\geq \emptyset 24$
FBH2526B	$\geq \emptyset 30.5$
FBH3233B	$\geq \emptyset 35$
FBH4042B	$\geq \emptyset 44$
FBH5053B	$\geq \emptyset 54$
FBH6368B	$\geq \emptyset 71.5$
FBH6398B	$\geq \emptyset 100$
FBH8098B	$\geq \emptyset 100$

A	Max. range of back boring (\emptyset)	A Max. value = $(2 \times C) - B$
B	Max. FBH body size (\emptyset)	B Max. value = $(2 \times C) - A$
C	Min. diameter for pass (\emptyset)	C Min. value = $(A + B) / 2$

Dial adjustment

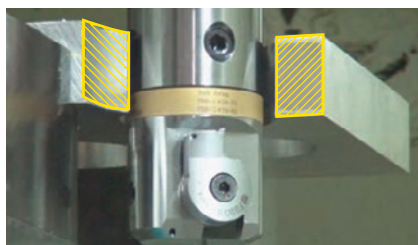
Fine adjustment : 2 μ m boring range

Can be adjusted at a rate of 2 μ m by using the main scale and vernier scale

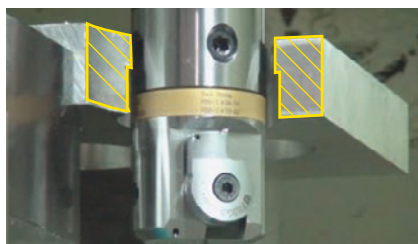


Back boring machining

Before machining



After machining



Convertible for machining direction

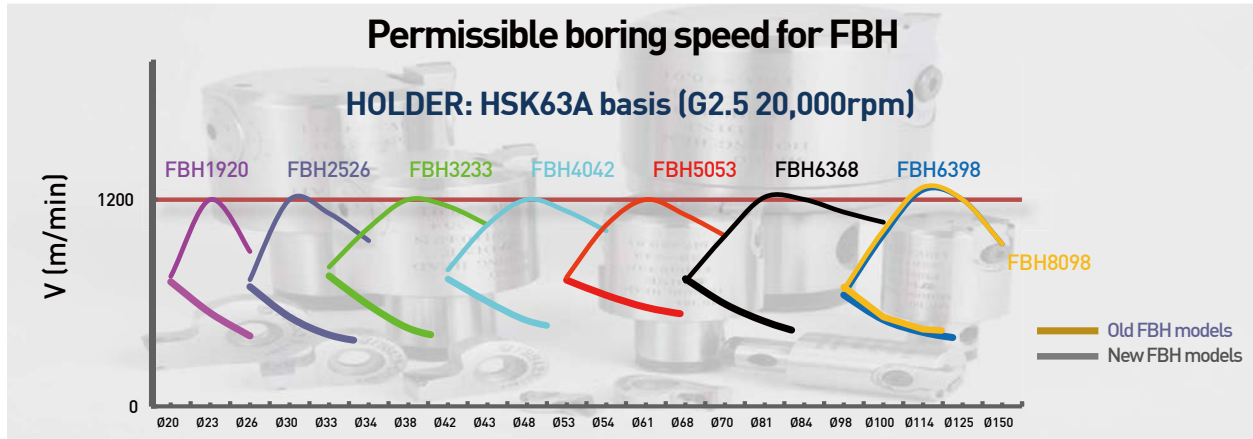


In case of boring machining

In case of back boring machining

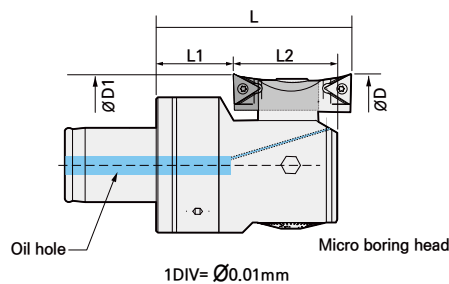
* Boring direction can be easily shifted simply by changing the bite direction

Test Results



Chuck	Model No. V(m/min)	FBH2526B	FBH2526N
HSK63A-MD25F-60	Difference in surface roughness	732 (6,861rpm)	
		- Constant and regular cycles are shown on the graph - Indicates stable boring work at high cutting speed	- Irregular cycles shown on the graph - Indicates unstable boring work at high cutting speed

Boring range



Model No.	Boring Range(Ø)			Backboring Range(Ø)			
	Min.	Max.	L	Min.	Max.	L1	L2
FBH1920B	20	26(30)	35.3	29	30	13.1	18.6
FBH2526B	26	34(40)	40.9	36	40	15.1	21.9
FBH3233B	33	43(50)	40.9	38	43(50)	13.1	24.9
FBH4042B	42	54(62)	50.4	48	54(62)	15.2	31.4
FBH5053B	53	70(82)	58.4	58	70(82)	15.7	38.4
FBH6368B	68	100(122)	80.6	78	100(122)	27.4	48.6
FBH6398B	98	150(172)	100.6	106	150(172)	47.4	48.6
FBH8098B	98	150(172)	100.6	106	150(172)	47.4	48.6



BT-FBH/B

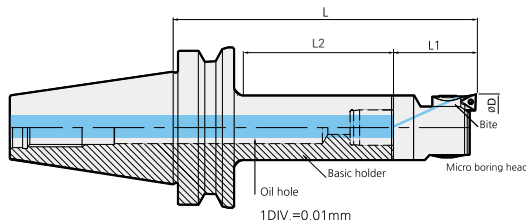
Micro boring bar (balanced type)



MAS 403-BT
G6.3
C
20
172

Shank G value Coolant System MIN Range MAX Range Boring

Fig.1



Head.1

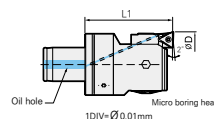
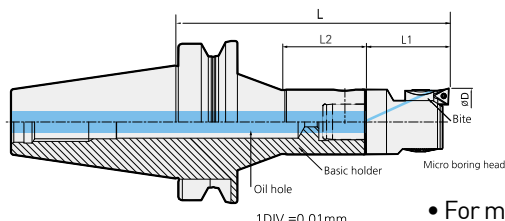


Fig.2



C Internal coolant system installed.

※ Red : Main component Blue : For separate purchase

- For more information on the product features, see **134p**
- For more information on MD arbor, see **126p**
- For more information on FBB bite, see **143p**
- For more information on the related parts, see **142p**

	Model No.			Boring range(ØD)		L	L1	L2	ØD	ØD1	kg (Head weight)	kg (Head package weight)	Fig
	Head model no.	Bite model no.	Arbor Model No.	Min.	Max.								
BT30	FBH1920B	FBB20N-□-□□	BT30-MD19F-70	20(24)	26(30)	105.2	35.2	45	19	11	0.2	0.2	1
	FBH2526B	FBB26N-□-□□	BT30-MD25F-90	26(32)	34(40)	131	41	63	25	14	0.2	0.2	1
	FBH3233B	FBB33N-□-□□	BT30-MD32F-80	33(40)	43(50)	121	41	55	32	18	0.3	0.3	1
	FBH4042B	FBB42N-□-□□	BT30-MD40F-45	42(50)	54(62)	95.5	50.5	22	40	22	0.5	0.5	1
	FBH4042B	FBB42N-□-□□	BT30-MD40F-60	42(50)	54(62)	110.5	50.5	36	40	22	0.5	0.5	1
	FBH4042B	FBB42N-□-□□	BT30-MD40F-80	42(50)	54(62)	130.5	50.5	56	40	22	0.5	0.5	1
	FBH5053B	FBB53N-□-□□	BT30-MD50F-70	53(65)	70(82)	128.4	58.5	48	50	28	0.8	0.9	1
BT40	FBH1920B	FBB20N-□-□□	BT40-MD19F-70	20(24)	26(30)	105.4	35.2	40	19	11	0.2	0.2	1
	FBH2526B	FBB26N-□-□□	BT40-MD25F-95	26(32)	34(40)	135.9	41	63	25	14	0.2	0.2	1
	FBH2526B	FBB26N-□-□□	BT40-MD25F-105R	26(32)	34(40)	146	41	40	25	14	0.2	0.2	2
	FBH3233B	FBB33N-□-□□	BT40-MD32F-100	33(40)	43(50)	140.9	41	70	32	18	0.3	0.3	1
	FBH3233B	FBB33N-□-□□	BT40-MD32F-115R	33(40)	43(50)	156	41	45	32	18	0.3	0.3	2
	FBH4042B	FBB42N-□-□□	BT40-MD40F-60	42(50)	54(62)	165.5	50.5	31	40	22	0.5	0.5	1
	FBH4042B	FBB42N-□-□□	BT40-MD40F-110R	42(50)	54(62)	160.5	50.5	60	40	22	0.5	0.5	2
	FBH4042B	FBB42N-□-□□	BT40-MD40F-115	42(50)	54(62)	165.5	50.5	83	40	22	0.5	0.5	1
	FBH5053B	FBB53N-□-□□	BT40-MD50F-105	53(65)	70(82)	163.4	58.5	73	50	28	0.8	0.9	1
	FBH5053B	FBB53N-□-□□	BT40-MD63F-64	53(65)	70(82)	122.5	58.5	37	50	28	0.8	0.9	1
	FBH6368B	FBB68N-□-□□	BT40-MD63F-110	68(90)	100(122)	190.6	80.6	83	63	36	2.1	2.3	1
	FBH6398B	FBB68N-□-□□	BT40-MD63F-135	98(120)	150(172)	235.6	100.6	108	63	36	3.6	3.8	1
	FBH8098B	FBB68N-□-□□	BT40-MD80F-100	98(120)	150(172)	200.6	100.6	73	80	45	4.8	5.1	1

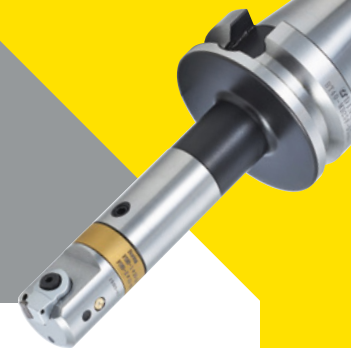
- In the above table, the Arbor Model No. is an example model no. and able to adjust the depth of boring with a combination of MD arbors and extension bars. For more details, see the MD arbor page.
- FBB bite is largely divided into general-type FBB□□N and extended-type (back boring) FBB□□N-1 and is available as FBB□□N-□-C09, FBB□□N-□-T11 depending on the insert.

Bite	Applicable insert
FBB□□N, FBB□□N-1	TPGT TPGW0802□□L
FBB□□N-□-C	CCMT, CCGT0602□□L
FBB□□N-□-C09	CCMT, CCGT09T3□□L
FBB□□N-□-T11	TPGT1103□□L



BT-FBH/B

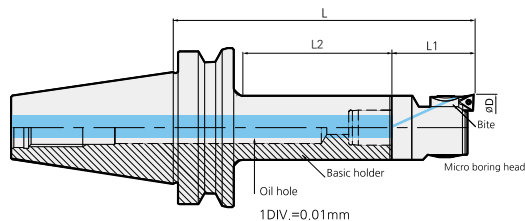
Micro boring bar (balanced type)



MAS 403-BT
G6.3
C
20
172

Shank G value Coolant System MIN Range MAX Range Boring

Fig.1



Head.1

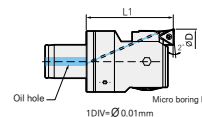
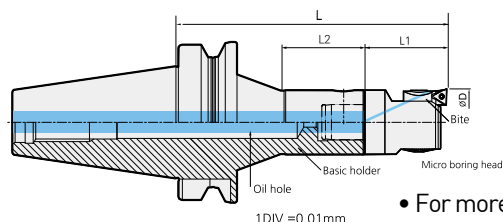


Fig.2



- For more information on the product features, see **134p**
- For more information on MD arbor, see **126p**
- For more information on FBB bite, see **143p**
- For more information on the related parts, see **142p**

C Internal coolant system installed.

※ Red : Main component Blue : For separate purchase

	Model No.			Boring range(ØD)		L	L1	L2	ØD	ØD1	kg (Head weight)	kg (Head package weight)	Fig
	Head model no.	Bite model no.	Arbor Model No.	Min.	Max.								
BT50	FBH1920B	FBB20N-□-□□	BT50-MD19F-85	20(24)	26(30)	120.2	35.2	44	19	11	0.2	0.2	1
	FBH2526B	FBB26N-□-□□	BT50-MD25F-105	26(32)	34(40)	146	41	62	25	14	0.2	0.2	1
	FBH2526B	FBB26N-□-□□	BT50-MD25F-120R	26(32)	34(40)	161	41	40	25	14	0.2	0.2	2
	FBH3233B	FBB33N-□-□□	BT50-MD32F-110	33(40)	43(50)	151	41	67	32	18	0.3	0.3	1
	FBH3233B	FBB33N-□-□□	BT50-MD32F-115R	33(40)	43(50)	156	41	45	32	18	0.3	0.3	2
	FBH3233B	FBB33N-□-□□	BT50-MD32F-235R	33(40)	43(50)	276	41	115	32	18	0.3	0.3	2
	FBH4042B	FBB42N-□-□□	BT50-MD40F-60	42(50)	54(62)	110.5	50.5	22	32	18	0.5	0.5	1
	FBH4042B	FBB42N-□-□□	BT50-MD40F-195	42(50)	54(62)	245.5	50.5	152	40	22	0.5	0.5	1
	FBH4042B	FBB42N-□-□□	BT50-MD40F-230R	42(50)	54(62)	280.5	50.5	180	40	22	0.5	0.5	2
	FBH5053B	FBB53N-□-□□	BT50-MD50F-125	53(65)	70(82)	183.5	58.5	82	40	22	0.8	0.9	1
	FBH5053B	FBB53N-□-□□	BT50-MD50F-225	53(65)	70(82)	283.5	58.5	182	50	28	0.8	0.9	1
	FBH5053B	FBB53N-□-□□	BT50-MD50F-205R	53(65)	70(82)	263.5	58.5	81	50	28	0.8	0.9	2
	FBH6368B	FBB68N-□-□□	BT50-MD63F-75	68(90)	100(122)	145.6	80.6	35	63	36	2.1	2.3	1
	FBH6368B	FBB68N-□-□□	BT50-MD63F-130	68(90)	100(122)	200.6	80.6	87	63	36	2.1	2.3	1
	FBH6368B	FBB68N-□-□□	BT50-MD63F-195	68(90)	100(122)	310.6	80.6	152	63	36	2.1	2.3	1
	FBH6368B	FBB68N-□-□□	BT50-MD63F-230	68(90)	100(122)	265.6	265.6	187	63	36	2.1	2.3	1
	FBH6398B	FBB68N-□-□□	BT50-MD63F-75	98(120)	150(172)	175.6	100.6	35	63	36	3.6	3.8	1
	FBH6398B	FBB68N-□-□□	BT50-MD63F-130	98(120)	150(172)	230.6	100.6	87	63	36	3.6	3.8	1
	FBH6398B	FBB68N-□-□□	BT50-MD63F-195	98(120)	150(172)	295.6	100.6	152	63	36	3.6	3.8	1
	FBH6398B	FBB68N-□-□□	BT50-MD63F-230	98(120)	150(172)	330.6	100.6	187	63	36	3.6	3.8	1
FBH8098B	FBB68N-□-□□	BT50-MD80F-75	98(120)	150(172)	175.6	100.6	36	80	45	4.8	5.1	1	
FBH8098B	FBB68N-□-□□	BT50-MD80F-110	98(120)	150(172)	215.6	100.6	69	80	45	4.8	5.1	1	
FBH8098B	FBB68N-□-□□	BT50-MD80F-175	98(120)	150(172)	275.6	100.6	134	80	45	4.8	5.1	1	

- In the above table, the Arbor Model No. is an example model no. and able to adjust the depth of boring with a combination of MD arbors and extension bars. For more details, see the MD arbor page.
- FBB bite is largely divided into general-type FBB□□N and extended-type (back boring) FBB□□N-1 and is available as FBB□□N-□-C09, FBB□□N-□-T11 depending on the insert.

Bite	Applicable insert
FBB□□N, FBB□□N-1	TPGT TPGW0802□□L
FBB□□N-□-C	CCMT, CCGT0602□□L
FBB□□N-□-C09	CCMT, CCGT09T3□□L
FBB□□N-□-T11	TPGT1103□□L

Chuck

Arbor / Modular

Boring tool

Angular head

cBN/PCD

Smart factory

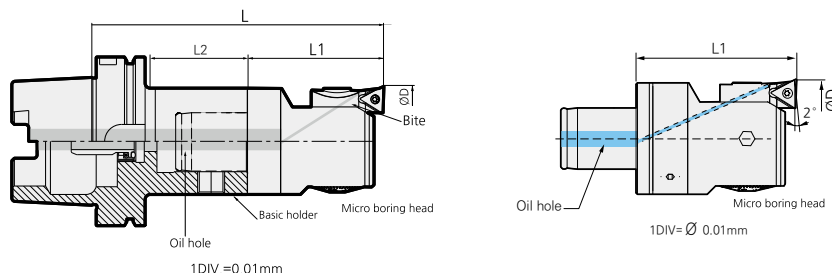
TAUMAX

OTHER



HSK-FBH/B

Micro boring bar (balanced type)



- For more information on the product features, see **134p**
- For more information on MD arbor, see **126p**
- For more information on FBB bite, see **143p**
- For more information on the related parts, see **142p**

C Internal coolant system is optional.

※ Red : Main component Blue : For separate purchase

HSK63	Model No.			Boring range(ØD)		L	L1	L2	ØD	ØD1	kg (Head weight)	kg (Head package weight)	Fig
	Head model no.	Bite model no.	Arbor Model No.	Min.	Max.								
	FBH1920B	FBB20N-□-□□	HSK63A-MD19F-60	20(24)	26(30)								
FBH2526B	FBB26N-□-□□	HSK63A-MD25F-60	26(32)	34(40)	101	41	31	25	14	0.2	0.2	1	
FBH3233B	FBB33N-□-□□	HSK63A-MD32F-65	33(40)	43(50)	106	41	36	32	18	0.3	0.3	1	
FBH4042B	FBB42N-□-□□	HSK63A-MD40F-70	42(50)	54(62)	120.5	50.5	41	40	22	0.5	0.5	1	
FBH5053B	FBB53N-□-□□	HSK63A-MD50F-85	53(65)	70(82)	143.5	58.5	58	50	28	0.8	0.9	1	
FBH6368B	FBB68N-□-□□	HSK63A-MD63F-95	68(90)	100(122)	175.6	80.6	69	63	36	2.1	2.3	1	
FBH6398B	FBB68N-□-□□	HSK63A-MD63F-95	98(120)	150(172)	195.6	100.6	69	63	36	3.6	3.8	1	

- In the above table, the Arbor Model No. is an example model no. and able to adjust the depth of boring with a combination of MD arbors and extension bars. For more details, see the MD arbor page.
- FBB bite is largely divided into general-type FBB□□N and extended-type (back boring) FBB□□N-1 and is available as FBB□□N-□-C09, FBB□□N-□-T11 depending on the insert.

Bite	Applicable insert
FBB□□N, FBB□□N-1	TPGT TPGW0802□□L
FBB□□N-□-C	CCMT, CCGT0602□□L
FBB□□N-□-C09	CCMT, CCGT09T3□□L
FBB□□N-□-T11	TPGT1103□□L

For separate purchase

Internal coolant system

Classification by shank	
HSK50	HSK50A-CNS
HSK63	HSK63A-CNS
HSK100	HSK100A-CNS



SK-FBH/B

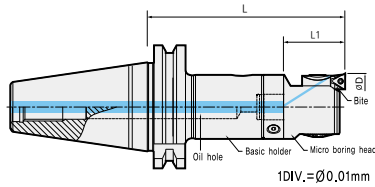
Micro boring bar (balanced type)



DIN69871
-1A/B
G6.3
C
26
172
Boring

Shank G value Coolant System MIN Range MAX Range Boring

Fig.1



Head.1

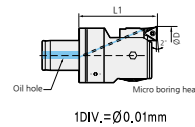


Fig.2

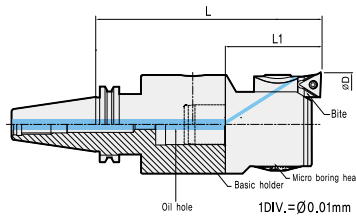
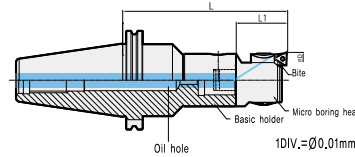


Fig.3



- For more information on the product features, see **134p**
- For more information on MD arbor, see **126p**
- For more information on FBB bite, see **143p**
- For more information on the related parts, see **142p**

C Internal coolant system installed.

※ Red : Main component Blue : For separate purchase

	Model No.			Boring range(ØD)		L	L1	L2	ØD	ØD1	kg (Head weight)	kg (Head package weight)	Fig
	Head model no.	Bite model no.	Arbor Model No.	Min.	Max.								
SK40	FBH2526B	FBB26N-□-□□	SK40-MD25F-80R	26(32)	34(40)	121	41	22	25	14	0.2	0.2	3
	FBH3233B	FBB33N-□-□□	SK40-MD32F-115R	33(40)	43(50)	156	41	36	32	18	0.3	0.3	3
	FBH4042B	FBB42N-□-□□	SK40-MD40F-100	42(50)	54(62)	150.5	50.5	80	40	22	0.5	0.5	1
	FBH5053B	FBB53N-□-□□	SK40-MD50F-100	53(65)	70(82)	158.5	58.5	80	50	28	0.8	0.9	1
	FBH6368B	FBB68N-□-□□	SK40-MD63F-70	68(90)	100(122)	150.6	80.6	50	63	36	2.1	2.3	2
SK50	FBH6398B	FBB68N-□-□□	SK40-MD63F-70	98(120)	150(172)	170.6	100.6	50	63	36	3.6	3.8	2
	FBH2526B	FBB26N-□-□□	SK50-MD25F-105R	26(32)	34(40)	146	41	22	25	14	0.2	0.2	3
	FBH3233B	FBB33N-□-□□	SK50-MD32F-110	33(40)	43(50)	151	41	87	32	18	0.3	0.3	1
	FBH4042B	FBB42N-□-□□	SK50-MD40F-145	42(50)	54(62)	195.5	50.5	120	40	22	0.5	0.5	1
	FBH5053B	FBB53N-□-□□	SK50-MD50F-240R	53(65)	70(82)	298.5	58.5	125	50	28	0.8	0.9	3
	FBH6368B	FBB68N-□-□□	SK50-MD63F-130	68(90)	100(122)	210.6	80.6	107	63	36	2.1	2.3	1
	FBH6398B	FBB68N-□-□□	SK50-MD63F-130	98(120)	150(172)	230.6	100.6	107	63	36	3.6	3.8	1
	FBH8098B	FBB68N-□-□□	SK50-MD80F-150	98(120)	150(172)	250.6	100.6	130	80	45	4.8	5.1	1

- In the above table, the Arbor Model No. is an example model no. and able to adjust the depth of boring with a combination of MD arbors and extension bars. For more details, see the MD arbor page.
- FBB bite is largely divided into general-type FBB□□N and extended-type (back boring) FBB□□N-1 and is available as FBB□□N-□-C09, FBB□□N-□-T11 depending on the insert.

Bite	Applicable insert
FBB□□N, FBB□□N-1	TPGT TPGW0802□□L
FBB□□N-□-C	CCMT, CCGT0602□□L
FBB□□N-□-C09	CCMT, CCGT09T3□□L
FBB□□N-□-T11	TPGT1103□□L



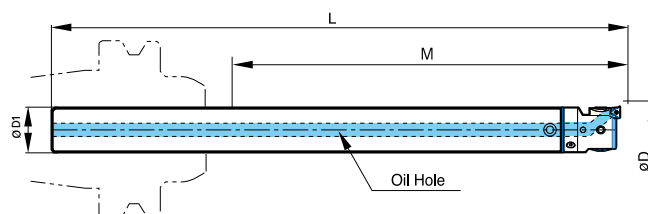
S-FBH/B

Micro boring bar (balanced type)



CARBIDE
C
20
43

Shank Coolant System MIN Range MAX Range Boring



C Internal coolant system installed.

*S□□W : Cemented carbide shank

*S□□ : Steel shank

• For more information on the product features, see **134p**

• For more information on FBB bite, see **143p**

• For more information on the related parts, see **142p**

Model No.	Boring range		L	ØD1	M	Main component			kg (Head weight)	kg (Head package weight)
	Min.	Max.				Shank	Boring head	Bite		
S19W-FBH20B-120	20	26	192.35	19	120	S19W-MD19F-157	FBH1920B	FBB20N	0.6	0.7
S19W-FBH20B-140	20	26	212.35	19	140	S19W-MD19F-177	FBH1920B	FBB20N	0.7	0.8
S19W-FBH20B-160	20	26	232.35	19	160	S19W-MD19F-197	FBH1920B	FBB20N	0.8	0.9
S25W-FBH26B-150	26	34	238.35	25	150	S25W-MD25F-197.5	FBH2526B	FBB26N	1.4	1.5
S25W-FBH26B-175	26	34	263.35	25	175	S25W-MD25F-222.5	FBH2526B	FBB26N	1.6	1.7
S25W-FBH26B-200	26	34	288.35	25	200	S25W-MD25F-247.5	FBH2526B	FBB26N	1.8	1.9
S32W-FBH33B-180	33	43	279.9	32	180	S32W-MD32F-239	FBH3233B	FBB33N	2.7	2.8
S32W-FBH33B-240	33	43	339.9	32	240	S32W-MD32F-299	FBH3233B	FBB33N	3.4	3.5
S19-FBH20B-40	20	26	112.35	19	40	S19-MD19F-77	FBH1920B	FBB20N	0.2	0.3
S19-FBH20B-80	20	26	152.35	19	80	S19-MD19F-117	FBH1920B	FBB20N	0.2	0.3
S25-FBH26B-50	26	34	138.35	25	50	S25-MD25F-97.5	FBH2526B	FBB26N	0.4	0.5
S25-FBH26B-100	26	34	188.35	25	100	S25-MD25F-147.5	FBH2526B	FBB26N	0.6	0.7
S32-FBH33B-90	33	43	189.9	32	90	S32-MD32F-149	FBH3233B	FBB33N	1.1	1.2
S32-FBH33B-120	33	43	219.9	32	120	S32-MD32F-179	FBH3233B	FBB33N	1.2	1.3

• FBB bite is largely divided into general-type FBB□□N and extended-type (back boring) FBB□□N-1 and is available as FBB□□N-□-C09, FBB□□N-□-T11 depending on the insert.

Bite	Applicable insert
FBB□□N, FBB□□N-1	TPGT TPGW0802□□L
FBB□□N-□-C	CCMT, CCGT0602□□L
FBB□□N-□-C09	CCMT, CCGT09T3□□L
FBB□□N-□-T11	TPGT1103□□L

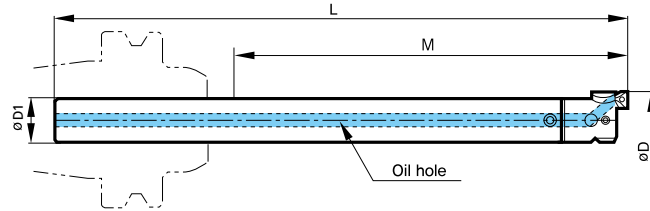


S-FBH

Small micro boring bar with carbide/steel



CARBIDE	C	15	22	
Shank	Coolant System	MIN Range	MAX Range	Boring



C Internal coolant system installed.

* S□□W : Cemented carbide shank

* S□□ : Steel shank

• For more information on the product features, see **134p**

• For more information on FBB bite, see **143p**

• For more information on the related parts, see **142p**

CEMENTED CARBIDE	Model No.	Boring range		L	$\phi D1$	M	Detailed model no. (Main component)			kg (Head weight)	kg (Head package weight)
		Min.	Max.				Shank	Boring head	Bite		
	S14W-FBH15-85	15	18	155	14	85	S14W-M6-123	FBH15	FBB15-C	0.3	0.4
	S14W-FBH15-110	15	18	180	14	110	S14W-M6-148	FBH15	FBB15-C	0.3	0.4
	S16W-FBH18-95	18	22	165	16	95	S16W-M8-128	FBH18	FBB15-C	0.4	0.5
	S16W-FBH18-125	18	22	195	16	125	S16W-M8-158	FBH18	FBB15-C	0.5	0.6
	S14-FBH15-40	15	18	110	14	40	S14-M6-78	FBH15	FBB15-C	0.1	0.2
	S16-FBH18-45	18	22	115	16	45	S16-M8-78	FBH18	FBB15-C	0.1	0.2

• FBB bite is largely divided into general-type FBB□□N and extended-type (back boring) FBB□□N-1 and is available as FBB□□N-□-C09 and FBB□□N-□-T11 depending on the insert.

Bite	Applicable insert
FBB□□N, FBB□□N-1	TPGT TPGW0802□□L
FBB□□N-□-C	CCMT, CCGT0602□□L
FBB□□N-□-C09	CCMT, CCGT09T3□□L
FBB□□N-□-T11	TPGT1103□□L



FBH SPARE PART

Micro boring related parts



Spare Part

Main components			
TYPE(FBH)	LOCK SEREW	FBB	CLAMP SCREW
FBH15	BT02503	FBB15-C	BFTX02505N
FBH18	BT02503	FBB15-C	BFTX02505N






FBH/B SPARE PART

Micro boring balanced type related parts



Main components

Main components			
TYPE(FBH/B)	LOCK SCREW	CLAMP SCREW	Wrench
			
FBH1920B	BTF0404	BXC0304	LW-2
FBH2526B	BTF0505	BXC0405	LW-2.5
FBH3233B	BTF0606	BXC0506	LW-3
FBH4042B	BTF0808	BXC0610	LW-4
FBH5053B	BTF0812	BXC0610	LW-4
FBH6368B	BTF1016	BXC0810	LW-5
FBH6398B	BTF1012	BXC0810	LW-5
FBH8098B	BTF1014	BXC0810	LW-5



FBB BITE

Boring bite



NAMING

FBB	-	20	N	-	1
FBH Bite		Head No.	New Type		Non : General type 1 : Expansion type

Spare Part

Model No.	Boring range	Insert	Insert screw	Clamp bolt
FBB15-C	Ø15 ~ Ø18mm	CCET0301-□□L	BFTX01604N	BFTX02506N
	Ø18 ~ Ø22mm	CCET0301-□□L	BFTX01604N	BFTX02506N
FBB20N	Ø20 ~ Ø26mm	TPGT0802□□L,TPGW0802□□	BFTX0204A	BXC0304
FBB20N-C	Ø20 ~ Ø26mm	CCET0401□□L	FTNA0238	BXC0304
FBB20N-1	Ø24 ~ Ø30mm	TPGT0802□□L,TPGW0802□□	BFTX0204A	BXC0304
FBB20N-1-C	Ø24 ~ Ø30mm	CCET0401□□L	FTNA0238	BXC0304
FBB26N	Ø26 ~ Ø34mm	TPGT0802□□L,TPGW0802□□	BFTX0204A	BXC0405
FBB26N-C	Ø26 ~ Ø34mm	CCET0401□□L	FTNA0238	BXC0405
FBB26N-1	Ø32 ~ Ø40mm	TPGT0802□□L,TPGW0802□□	BFTX0204A	BXC0405
FBB26N-1-C	Ø32 ~ Ø40mm	CCET0401□□L	FTNA0238	BXC0405
FBB33N	Ø33 ~ Ø43mm	TPGT0802□□L,TPGW0802□□	BFTX0204A	BXC0506
FBB33N-C	Ø33 ~ Ø43mm	CCMT0602□□,CCGT0602□□	BFTX02506N	BXC0506
FBB33N-1	Ø41~ Ø50mm	TPGT0802□□L,TPGW0802□□	BFTX0204A	BXC0506
FBB33N-1-C	Ø41~ Ø50mm	CCMT0602□□,CCGT0602□□L	BFTX02506N	BXC0506
FBB42N	Ø42~ Ø54mm	TPGT0802□□L,TPGW0802□□	BFTX0204A	BXC0610
FBB42N-C	Ø42~ Ø54mm	CCMT0602□□,CCGT0602□□L	BFTX02506N	BXC0610
FBB42N-11	Ø42~ Ø54mm	TPGT1103□□L	BFTX0307A	BXC0610
FBB42N-1	Ø50~ Ø62mm	TPGT0802□□L,TPGW0802□□	BFTX0204A	BXC0610
FBB42N-1-C	Ø50~ Ø62mm	CCMT0602□□,CCGT0602□□L	BFTX02506N	BXC0610
FBB42N-1-T11	Ø50~ Ø62mm	TPGT1103□□L	BFTX0307A	BXC0610
FBB53N	Ø53~ Ø70mm	TPGT0802□□L,TPGW0802□□	BFTX0204A	BXC0610
FBB53N-C	Ø53~ Ø70mm	CCMT0602□□,CCGT0602□□	BFTX02506N	BXC0610
FBB53N-11	Ø53~ Ø70mm	TPGT1103□□L	BFTX0307A	BXC0610
FBB53N-1	Ø65~ Ø82mm	TPGT0802□□L,TPGW0802□□	BFTX0204A	BXC0610
FBB53N-1-C	Ø65~ Ø82mm	CCMT0602□□,CCGT0602□□L	BFTX02506N	BXC0610
FBB53N-1-C09	Ø65~ Ø82mm	CCMT09T3□□,CCGT09T3□□L	BFTX0409N	BXC0610
FBB53N-1-T11	Ø65~ Ø82mm	TPGT1103□□L	BFTX0307A	BXC0610
FBB68N	Ø68~ Ø100mm / Ø98~ Ø150mm	TPGT0802□□L,TPGW0802□□	BFTX0204A	BXC0810
FBB68N-C	Ø68~ Ø100mm / Ø98~ Ø150mm	CCMT09T3□□,CCGT09T3□□L	BFTX0409N	BXC0810
FBB68N-11	Ø68~ Ø100mm / Ø98~ Ø150mm	TPGT1103□□L	BFTX0307A	BXC0810
FBB68N-1	Ø90~ Ø122mm / Ø120~ Ø172mm	TPGT0802□□L,TPGW0802□□	BFTX0204A	BXC0810
FBB68N-1-C09	Ø90~ Ø122mm / Ø120~ Ø172mm	CCMT09T3□□,CCGT09T3□□L	BFTX0409N	BXC0810
FBB68N-1-T11	Ø90~ Ø122mm / Ø120~ Ø172mm	TPGT1103□□L	BFTX0307A	BXC0810

Chuck

Arbor / Modular

Boring tool

Angular head

cBN/PCD

Smart factory

TAUMAX

OTHER



DBCA NEW

New balance cut tool



C	28	136	
Coolant System	MIN Range	MAX Range	Boring



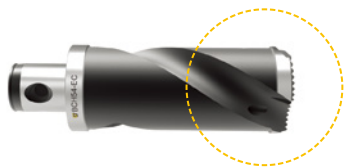
Features

- Applied adjustment function simultaneously in Bi/Uni-direction of Cartridge
- Improves the rigidity of cutting by applying Cover for rotating type
- Increased machining area versus conventional own products
- Improved capacity to evacuate chips by unique design of Helical Type Head
- Boring range : $\varnothing 28 - \varnothing 136$

MAKING	DBCA	32	33	S	32
	New balance cut tool	▶ MD Arbor Size	Min. boring dia.	Straight type	▶ H: Helical type, Non: Straight type

Main features

Helical Type

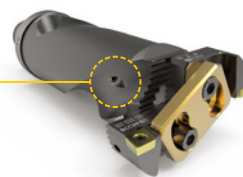


- Improved capacity to discharge chips from clogged and deep holes
- Minimized damage to tools and insert due to chip clogging

Extended head length	Deep hole machining implemented
Helical Type	Improved capacity to discharge chips from holes

Boring area optimization

Direction of spraying cutting oil

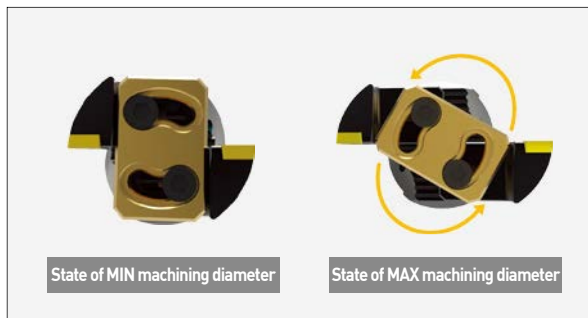


- Max. diameter expanded owing to reinforced rigidity
- Boring range expanded per model no. versus conventional boring range of DINE

Coolant Hole (Direct spray to cutting edge)	<ul style="list-style-type: none"> • Improved capacity to discharge chips • Improved capacity of machining
---	--

Effect of improved rigidity for Cartridge by Cover

Clamps the top of the cartridge stably, minimizing the vibration of tools and improving the roughness of the working surface





DBCA NEW

New balance cut tool



Comparison with competitors

Verifying of less vibration due to improved rigidity and smooth chip discharge

→ Superior performance compared to competitors

MANUFACTURER	L/D	SURFACE ROUGHNESS (RA)	SPECIAL NOTES	MACHINED SURFACE
Company A	5D	3.82	Vibration occurred	
Company B	5D	2.46	Vibration occurred Chips tangled	
DINE took over	5D	2.19	Well-machined surface No chip tangled	

New machining range versus old machining range of DINE

OLD TYPE



NEW TYPE



Designation	Boring Range ØD	
	min	max
DBC2528S	28	35
DBC3235S	35	46
DBC4046S	46	58
DBC5058S	58	74
DBC6347S	74	94
DBC8094S	94	120

Designation	Boring Range ØD	
	min	max
DBCA2528S-H	28	38
DBCA3238S-H	38	54
DBCA5054S-H	54	74
DBCA6374S-H	74	100
DBCA80100S-H	100	136

Detailed Specifications

	Designation	Cartridge (Standard)	Step Cartridge	Step Cartridge Bite	
				CC Type	WC Type
				DBCA2528S-□	BCC28-EC
DBCA3238S-□	BCC38-EC	BCC38SB	SBB54-CC	SBB54-WC	
DBCA5054S-□	BCC54-EC	BCC54SB	SBB74-CC	SBB74-WC	
DBCA6374S-□	BCC74-EC	BCC74SB			
DBCA80100S-□	BCC100-EC	BCC100SB			

Comparison with competitors

MACHINING CONDITIONS	Vc(m/min)	f(mm/rev)	ap(mm)	MATERIAL	ITEM	DEPTH OF HALL
	200	0.08	2	S45C	Penetration hall	30

MANUFACTURER	Insert	GAUGE LINE (HEAD+SHANK)	BORING DIAMETER	L/D	SURFACE ROUGHNESS (RA)	SPECIAL NOTES	MACHINED SURFACE	TOOL TOP	TOOL SIDE
Competitor A	SCMT09T0304	164	Ø35	4.68	3.82	Vibration occurred			
Competitor B	CCMT080204	180	Ø35	5.14	2.46	Vibration occurred Chips tangled			
DINE	CCMT060204	175	Ø35	5	2.19	Well-machined surface No chip tangled			



BT-DBC/A (Helical Type)

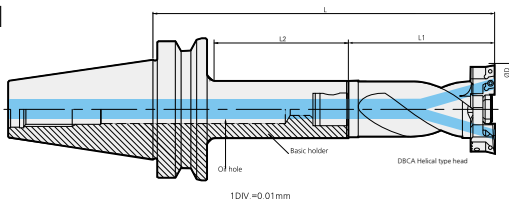
New balance cut tool(Helical Type)



MAS 403-BT
C
28
136
Boring

Shank Coolant System MIN Range MAX Range Boring

Fig.1



Head.1

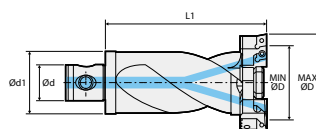
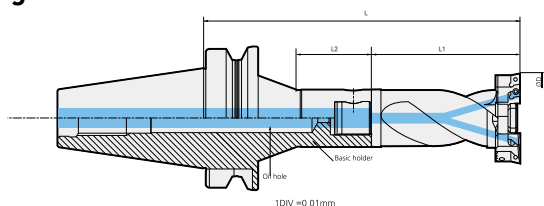


Fig.2



- For more information on the product features, see [144p](#)
- For more information on MD arbor, see [126p](#)
- For more information on the applicable insert, see [159p](#)
- For more information on the related parts, see [158p](#)

C Internal coolant system installed.

※ Red : Main component Blue : For separate purchase

	Model No.		Boring range(ØD)		L	L1	L2	Ød	Ød1	fig	kg (Head weight)	kg (Head package weight)
	Head model no.	Arbor Model No.	Min.	Max.								
BT30	DBCA2528S-H	BT30-MD25F-90	28	38	193	103	63	14	25	1	0.3	0.3
	DBCA3238S-H	BT30-MD32F-80	38	54	190	110	55	18	32	1	0.5	0.6
	DBCA5054S-H	BT30-MD50F-70	54	74	215	145	48	28	50	1	1.8	1.9
BT40	DBCA2528S-H	BT40-MD25F-95	28	38	198	103	63	14	25	1	0.3	0.3
	DBCA2528S-H	BT40-MD25F-105R	28	38	208	103	40	14	25	2	0.3	0.3
	DBCA3238S-H	BT40-MD32F-100	38	54	210	110	70	18	32	1	0.5	0.6
	DBCA3238S-H	BT40-MD32F-115R	38	54	225	110	45	18	32	2	0.5	0.6
	DBCA5054S-H	BT40-MD50F-105	54	74	250	145	73	28	50	1	1.8	1.9
	DBCA6374S-H	BT40-MD63F-64	74	100	244	180	37	36	63	1	3.3	3.5
	DBCA6374S-H	BT40-MD63F-110	74	100	290	180	83	36	63	1	3.3	3.5
	DBCA6374S-H	BT40-MD63F-135	74	100	315	180	108	36	63	1	3.3	3.5
	DBCA80100S-H	BT40-MD80F-100	100	136	315	215	73	45	80	1	7.3	7.6

• In the above table, the Arbor Model No. is an example model no. and able to adjust the depth of boring with a combination of MD arbors and extension bars. For more details, see the MD arbor page.

- DBCA2528S-H: CCMT0602□□
- DBCA3238S-H: CCMT0602□□
- DBCA5054S-H: CCMT09T3□□
- DBCA6374S-H: CCMT1204□□
- DBCA80100S-H: CCMT1204□□



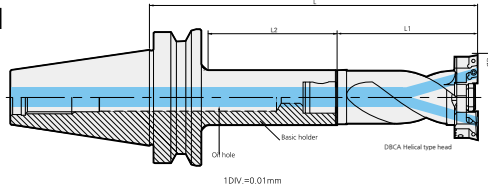
BT-DBC/A (Helical Type)

New balance cut tool(Helical Type)



MAS 403-BT	C	28	136	
Shank	Coolant System	MIN Range	MAX Range	Boring

Fig.1



Head.1

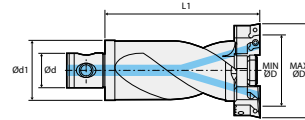
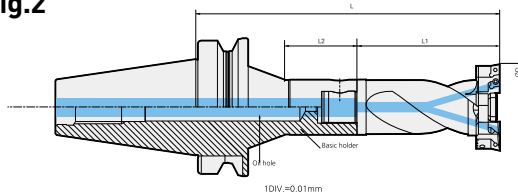


Fig.2



- For more information on the product features, see **144p**
- For more information on MD arbor, see **126p**
- For more information on the applicable insert, see **159p**
- For more information on the related parts, see **158p**

C Internal coolant system installed.

※ Red : Main component Blue : For separate purchase

	Model No.		Boring range(ØD)		L	L1	L2	Ød	Ød1	fig	kg (Head weight)	kg (Head package weight)
	Head model no.	Arbor Model No.	Min.	Max.								
BT50	DBCA2528S-H	BT50-MD25F-105	28	38	208	103	62	14	25	1	0.3	0.3
	DBCA2528S-H	BT50-MD25F-120R	28	38	223	103	40	14	25	2	0.3	0.3
	DBCA3238S-H	BT50-MD32F-110	38	54	220	110	67	18	32	1	0.5	0.6
	DBCA3238S-H	BT50-MD32F-115R	38	54	225	110	45	18	32	2	0.5	0.6
	DBCA3238S-H	BT50-MD32F-235R	38	54	345	110	115	18	32	2	0.5	0.6
	DBCA5054S-H	BT50-MD50F-125	54	74	270	145	82	28	50	1	1.8	1.9
	DBCA5054S-H	BT50-MD50F-225	54	74	370	145	182	28	50	1	1.8	1.9
	DBCA5054S-H	BT50-MD50F-250R	54	74	395	145	81	28	50	2	1.8	1.9
	DBCA6374S-H	BT50-MD63F-75	74	100	255	180	35	36	63	1	3.3	3.5
	DBCA6374S-H	BT50-MD63F-130	74	100	280	180	87	36	63	1	3.3	3.5
	DBCA6374S-H	BT50-MD63F-195	74	100	375	180	152	36	63	1	3.3	3.5
	DBCA6374S-H	BT50-MD63F-230	74	100	410	180	187	36	63	1	3.3	3.5
	DBCA80100S-H	BT50-MD80F-75	100	136	290	215	36	45	80	1	7.3	7.6
	DBCA80100S-H	BT50-MD80F-110	100	136	325	215	69	45	80	1	7.3	7.6
	DBCA80100S-H	BT50-MD80F-175	100	136	390	215	134	45	80	1	7.3	7.6

• In the above table, the Arbor Model No. is an example model no. and able to adjust the depth of boring with a combination of MD arbors and extension bars. For more details, see the MD arbor page.

- DBCA2528S-H: CCMT0602□□
- DBCA3238S-H: CCMT0602□□
- DBCA5054S-H: CCMT09T3□□
- DBCA6374S-H: CCMT1204□□
- DBCA80100S-H: CCMT1204□□



HSK-DBC/A (Helical Type)

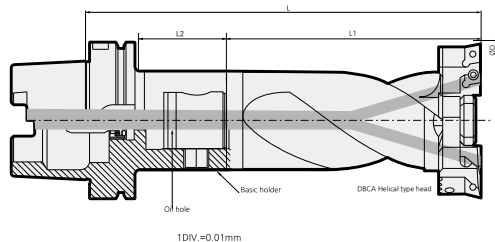
New balance cut tool(Helical Type)



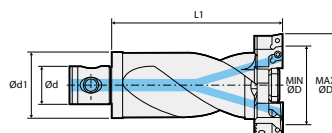
DIN 69893-1
C
38
100
Boring

Shank Coolant System MIN Range MAX Range Boring

Fig.1



Head.1



- For more information on the product features, see **144p**
 - For more information on MD arbor, see **126p**
- For more information on the applicable insert, see **159p**
 - For more information on the related parts, see **158p**

C Internal coolant system is optional.

※ Red : Main component Blue : For separate purchase

HSK63A	Model No.		Boring range(ØD)		L	L1	L2	Ød	Ød1	kg (Head weight)	kg (Head package weight)
	Head model no.	Arbor Model No.	Min.	Max.							
	DBCA2528S-H	HSK63A-MD25F-60	38	54	163	103	31	14	25	0.3	0.3
	DBCA3238S-H	HSK63A-MD32F-65	38	54	175	110	36	18	32	0.5	0.6
	DBCA5054S-H	HSK63A-MD50F-85	54	74	230	145	58	28	50	1.8	1.9
	DBCA6374S-H	HSK63A-MD63F-95	74	100	275	180	69	45	80	3.3	3.5

• In the above table, the Arbor Model No. is an example model no. and able to adjust the depth of boring with a combination of MD arbors and extension bars. For more details, see the MD arbor page.

- DBCA2528S-H: CCMT0602□□
- DBCA3238S-H: CCMT0602□□
- DBCA5054S-H: CCMT09T3□□
- DBCA6374S-H: CCMT1204□□
- DBCA80100S-H: CCMT1204□□

For separate purchase

Internal coolant system

Classification by shank	
HSK50	HSK50A-CNS
HSK63	HSK63A-CNS
HSK100	HSK100A-CNS



SK-DBC/A (Helical Type)

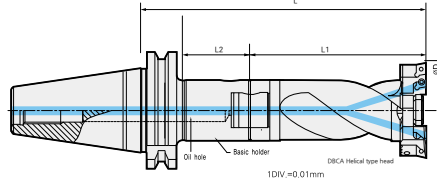
New balance cut tool(Helical Type)



DIN69871
-1A/B
C
Boring
38
136

Shank Coolant System Boring MIN Range MAX Range

Fig.1



Head.1

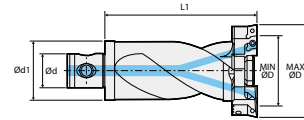


Fig.2

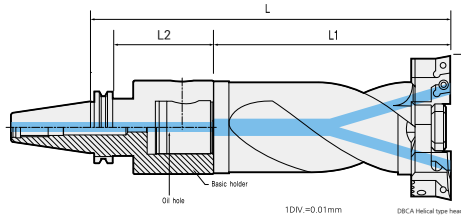
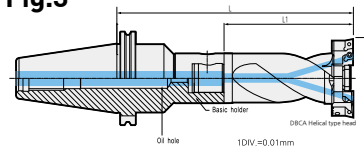


Fig.3



C Internal coolant system installed.

※ Red : Main component Blue : For separate purchase

- For more information on the product features, see 144p
- For more information on MD arbor, see 126p
- For more information on the applicable insert, see 159p
- For more information on the related parts, see 158p

Model No.		Boring range(ØD)		L	L1	L2	Ød	Ød1	Fig	kg (Head weight)	kg (Head package weight)	
Head model no.	Arbor Model No.	Min.	Max.									
SK40	DBCA2528S-H	SK40-MD25F-80R	38	54	183	103	22	14	25	3	0.3	0.3
	DBCA3238S-H	SK40-MD32F-115R	38	54	225	110	36	18	32	3	0.5	0.6
	DBCA5054S-H	SK40-MD50F-75	54	74	220	145	55	28	50	1	1.8	1.9
	DBCA5054S-H	SK40-MD50F-100	54	74	145	145	80	28	50	1	1.8	1.9
	DBCA6374S-H	SK40-MD63F-70	74	100	250	180	50	36	63	2	3.3	3.5
SK50	DBCA2528S-H	SK50-MD25F-80R	28	38	183	103	22	14	25	3	0.3	0.3
	DBCA2528S-H	SK50-MD25F-105R	28	38	208	103	22	14	25	3	0.3	0.3
	DBCA3238S-H	SK50-MD32F-110	38	54	220	110	87	18	32	1	0.5	0.6
	DBCA3238S-H	SK50-MD32F-110R	38	54	220	110	36	18	32	3	0.5	0.6
	DBCA5054S-H	SK50-MD50F-125R	54	74	270	145	60	28	50	3	1.8	1.9
	DBCA5054S-H	SK50-MD50F-240R	54	74	385	145	125	28	50	3	1.8	1.9
	DBCA6374S-H	SK50-MD63F-75	74	100	255	180	52	36	63	1	3.3	3.5
	DBCA6374S-H	SK50-MD63F-130	74	100	310	180	107	36	63	1	3.3	3.5
	DBCA6374S-H	SK50-MD63F-230R	74	100	410	180	149	36	63	3	3.3	3.5
	DBCA80100S-H	SK50-MD80F-95	100	136	310	215	75	45	80	1	7.3	7.6
	DBCA80100S-H	SK50-MD80F-150	100	136	365	215	130	45	80	1	7.3	7.6

• In the above table, the Arbor Model No. is an example model no. and able to adjust the depth of boring with a combination of MD arbors and extension bars. For more details, see the MD arbor page.

- DBCA2528S-H: CCMT0602□□
- DBCA3238S-H: CCMT0602□□
- DBCA5054S-H: CCMT09T3□□
- DBCA6374S-H: CCMT1204□□
- DBCA80100S-H: CCMT1204□□



BT-DBC/A (Straight Type)

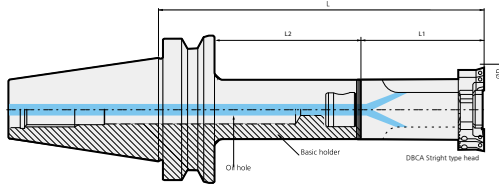
New balance cut tool (straight Type)



MAS 403-BT
C
28
136
Boring

Shank Coolant System MIN Range MAX Range Boring

Fig.1



Head

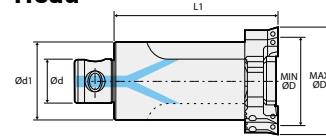
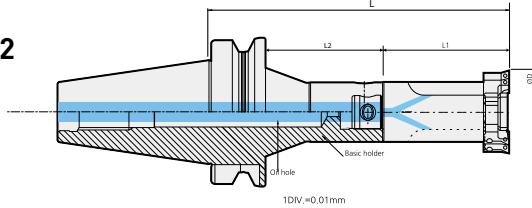


Fig.2



- For more information on the product features, see [144p](#)
- For more information on MD arbor, see [126p](#)
- For more information on the applicable insert, see [159p](#)
- For more information on the related parts, see [158p](#)

C Internal coolant system installed.

※ Red : Main component Blue : For separate purchase

	Model No.		Boring range(ØD)		L	L1	L2	Ød	Ød1	fig	kg (Head weight)	kg (Head package weight)
	Head model no.	Arbor Model No.	Min.	Max.								
BT30	DBCA2528S	BT30-MD25F-90	28	38	193	103	63	14	25	1	0.2	0.2
	DBCA3238S	BT30-MD32F-80	38	54	190	110	55	18	32	1	0.4	0.4
	DBCA5054S	BT30-MD50F-70	54	74	215	145	48	28	50	1	1.1	1.1
BT40	DBCA2528S	BT40-MD25F-95	28	38	198	103	63	14	25	1	0.2	0.2
	DBCA2528S	BT40-MD25F-105R	28	38	208	103	40	14	25	2	0.2	0.2
	DBCA3238S	BT40-MD32F-100	38	54	210	110	70	18	32	1	0.4	0.4
	DBCA3238S	BT40-MD32F-115R	38	54	225	110	45	18	32	2	0.4	0.4
	DBCA5054S	BT40-MD50F-105	54	74	205	145	73	28	50	1	1.1	1.1
	DBCA6374S	BT40-MD63F-64	74	100	244	180	37	36	63	1	1.9	2.1
	DBCA6374S	BT40-MD63F-135	74	100	315	180	83	36	63	1	1.9	2.1
	DBCA6374S	BT40-MD80F-100	74	100	280	180	108	36	63	1	1.9	2.1
	DBCA80100S	BT40-MD80F-100	100	136	315	215	73	45	80	1	3.7	3.9

• In the above table, the Arbor Model No. is an example model no. and able to adjust the depth of boring with a combination of MD arbors and extension bars. For more details, see the MD arbor page.

- DBCA2528S: CCMT0602□□
- DBCA3238S: CCMT0602□□
- DBCA5054S: CCMT09T3□□
- DBCA6374S: CCMT1204□□
- DBCA80100S: CCMT1204□□



BT-DBC/A (Straight Type)

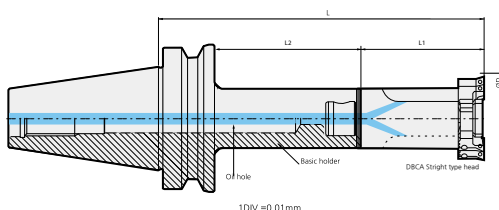
New balance cut tool(straight Type)



MAS 403-BT
C
28
136
Boring

Shank Coolant System MIN Range MAX Range Boring

Fig.1



Head

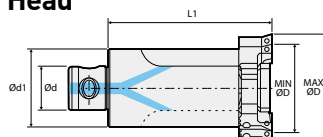
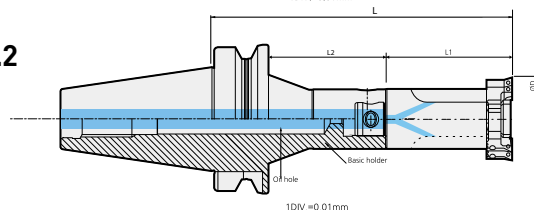


Fig.2



- For more information on the product features, see **144p**
- For more information on MD arbor, see **126p**
- For more information on the applicable insert, see **159p**
- For more information on the related parts, see **158p**

C Internal coolant system installed.

※ Red : Main component Blue : For separate purchase

	Model No.		Boring range(ØD)		L	L1	L2	Ød	Ød1	fig	kg (Head weight)	kg (Head package weight)
	Head model no.	Arbor Model No.	Min.	Max.								
BT50	DBCA2528S	BT50-MD25F-105	28	38	208	103	62	14	25	1	0.2	0.2
	DBCA2528S	BT50-MD25F-120R	28	38	223	103	40	14	25	2	0.2	0.2
	DBCA3238S	BT50-MD32F-110	38	54	220	110	67	18	32	1	0.4	0.4
	DBCA3238S	BT50-MD32F-115R	38	54	225	110	45	18	32	2	0.4	0.4
	DBCA3238S	BT50-MD32F-235R	38	54	345	110	115	18	32	2	0.4	0.4
	DBCA5054S	BT50-MD50F-125	54	74	270	145	82	28	50	1	1.1	1.1
	DBCA5054S	BT50-MD50F-225	54	74	370	145	182	28	50	1	1.1	1.1
	DBCA5054S	BT50-MD50F-250R	54	74	395	145	81	28	50	2	1.1	1.1
	DBCA6374S	BT50-MD63F-75	74	100	255	180	35	36	63	1	1.9	2.1
	DBCA6374S	BT50-MD63F-130	74	100	310	180	87	36	63	1	1.9	2.1
	DBCA6374S	BT50-MD63F-195	74	100	375	180	152	36	63	1	1.9	2.1
	DBCA6374S	BT50-MD63F-230	74	100	410	180	187	36	63	1	1.9	2.1
	DBCA80100S	BT50-MD80F-75	100	136	290	215	36	45	80	1	3.7	3.9
	DBCA80100S	BT50-MD80F-110	100	136	325	215	69	45	80	1	3.7	3.9
DBCA80100S	BT50-MD80F-175	100	136	390	215	134	45	80	1	3.7	3.9	

• In the above table, the Arbor Model No. is an example model no. and able to adjust the depth of boring with a combination of MD arbors and extension bars. For more details, see the MD arbor page.

- DBCA2528S: CCMT0602□□
- DBCA3238S: CCMT0602□□
- DBCA5054S: CCMT09T3□□
- DBCA6374S: CCMT1204□□
- DBCA80100S: CCMT1204□□



HSK-DBC/A (Straight Type)

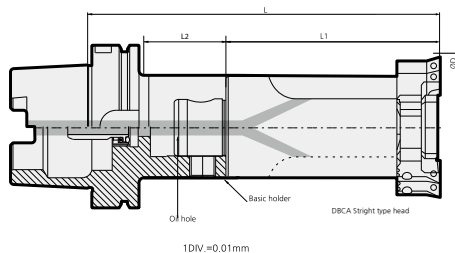
New balance cut tool (straight Type)



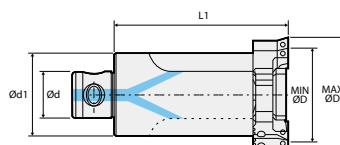
DIN 69893-1
C
38
100
Boring

Shank Coolant System MIN Range MAX Range Boring

Fig.1



Head.1



- For more information on the product features, see **144p**.
- For more information on MD arbor, see **126p**.
- For more information on the applicable insert, see **159p**.
- For more information on the related parts, see **158p**.

C Internal coolant system is optional.

※ Red : Main component Blue : For separate purchase

HSK63A	Model No.		Boring range(ØD)		L	L1	L2	Ød	Ød1	kg (Head weight)	kg (Head package weight)
	Head model no.	Arbor Model No.	Min.	Max.							
	DBCA2528S	HSK63A-MD25F-60	38	54	122	62	31	14	25	0.3	0.3
	DBCA3238S	HSK63A-MD32F-65	38	54	134.5	69.5	36	18	32	0.5	0.6
	DBCA5054S	HSK63A-MD50F-85	54	74	179	94	58	28	50	1.8	1.9
	DBCA6374S	HSK63A-MD63F-95	74	100	206.5	106.5	69	45	80	3.3	3.5

• In the above table, the Arbor Model No. is an example model no. and able to adjust the depth of boring with a combination of MD arbors and extension bars. For more details, see the MD arbor page.

- DBCA2528S: CCMT0602□□
- DBCA3238S: CCMT0602□□
- DBCA5054S: CCMT09T3□□
- DBCA6374S: CCMT1204□□
- DBCA80100S: CCMT1204□□

For separate purchase

Internal coolant system

Classification by shank	
HSK50	HSK50A-CNS
HSK63	HSK63A-CNS
HSK100	HSK100A-CNS



SK-DBC/A (Straight Type)

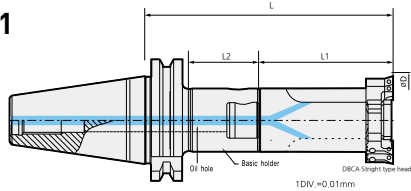
New balance cut tool(straight Type)



DIN69871
-1A/B
C
38
136

Shank Coolant System MIN Range MAX Range Boring

Fig.1



Head

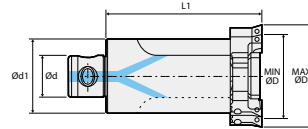


Fig.2

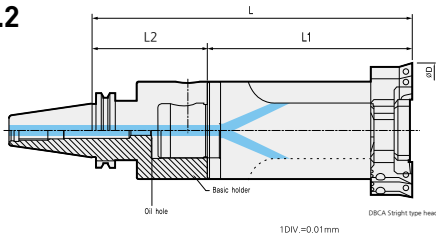
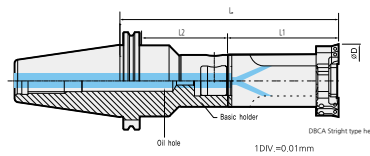


Fig.3



C Internal coolant system installed.

※ Red : Main component Blue : For separate purchase

- For more information on the product features, see 144p
- For more information on MD arbor, see 126p
- For more information on the applicable insert, see 159p
- For more information on the related parts, see 158p

	Model No.		Boring range(ØD)		L	L1	L2	Ød	Ød1	Fig	kg (Head weight)	kg (Head package weight)
	Head model no.	Arbor Model No.	Min.	Max.								
SK40	DBCA2528S	SK40-MD25F-80R	38	54	183	103	22	14	25	3	0.3	0.3
	DBCA3238S	SK40-MD32F-115R	38	54	225	110	36	18	32	3	0.5	0.6
	DBCA5054S	SK40-MD50F-75	54	74	220	145	55	28	50	1	1.8	1.9
	DBCA5054S	SK40-MD50F-100	54	74	245	145	80	28	50	1	1.8	1.9
	DBCA6374S	SK40-MD63F-70	74	100	250	180	50	36	63	2	3.3	3.5
SK50	DBCA2528S	BT50-MD25F-80R	28	38	183	103	22	14	25	3	0.3	0.3
	DBCA2528S	BT50-MD25F-105R	28	38	208	103	22	14	25	3	0.3	0.3
	DBCA3238S	BT50-MD32F-110	38	54	220	110	87	18	32	1	0.5	0.6
	DBCA3238S	BT50-MD32F-110R	38	54	220	110	36	18	32	3	0.5	0.6
	DBCA5054S	BT50-MD50F-125R	54	74	270	145	60	28	50	3	1.1	1.1
	DBCA5054S	BT50-MD50F-240R	54	74	385	145	125	28	50	3	1.1	1.1
	DBCA6374S	BT50-MD63F-75	74	100	255	180	52	36	63	1	3.3	3.5
	DBCA6374S	BT50-MD63F-130	74	100	310	180	107	36	63	1	3.3	3.5
	DBCA6374S	BT50-MD63F-230R	74	100	410	180	149	36	63	3	3.3	3.5
	DBCA80100S	BT50-MD80F-95	100	136	310	215	75	45	80	1	7.3	7.6
DBCA80100S	BT50-MD80F-150	100	136	365	215	130	45	80	1	7.3	7.6	

• In the above table, the Arbor Model No. is an example model no. and able to adjust the depth of boring with a combination of MD arbors and extension bars. For more details, see the MD arbor page.

- DBCA2528S: CCMT0602□□
- DBCA3238S: CCMT0602□□
- DBCA5054S: CCMT09T3□□
- DBCA6374S: CCMT1204□□
- DBCA80100S: CCMT1204□□



BT-DBC

Balance cut tool(Rough Boring)



MAS 403-BT C 28 120 Boring
 Shank Coolant System MIN Range MAX Range

Fig.1

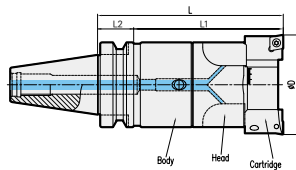
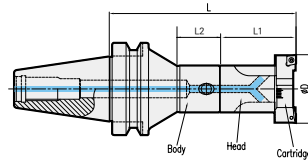
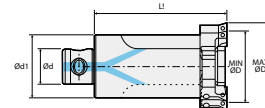


Fig.2



Head



C Internal coolant system installed.

※ Red : Main component Blue : For separate purchase

- For more information on MD arbor, see **126p**.
- For more information on the applicable insert, see **159p**.
- For more information on the related parts, see **158p**.

Model No.		Boring range(ØD)		L	L1	L2	Ød	Ød1	fig	kg (Head weight)	kg (Head package weight)	
Head model no.	Arbor Model No.	Min.	Max.									
BT30	DBC2528S	BT30-MD25F-90	28	35	150	60	63	14	25	1	0.3	0.3
	DBC3235S	BT30-MD32F-80	35	46	145	65	55	18	32	1	0.4	0.4
	DBC4046S	BT30-MD40F-45	46	58	115	70	22	22	40	1	0.6	0.7
	DBC4046S	BT30-MD40F-60	46	58	130	70	36	22	40	1	0.6	0.7
	DBC4046S	BT30-MD40F-80	46	58	140	70	56	22	40	1	0.6	0.7
	DBC5058S	BT30-MD50F-70	58	74	150	80	48	28	50	1	1.1	1.2
BT40	DBC2528S	BT40-MD25F-95	28	35	155	60	63	14	25	1	0.3	0.3
	DBC2528S	BT40-MD25F-105R	28	35	165	60	40	14	25	2	0.3	0.3
	DBC3235S	BT40-MD32F-100	35	46	165	65	70	18	32	1	0.4	0.4
	DBC3235S	BT40-MD32F-115R	35	46	180	65	45	18	32	2	0.4	0.4
	DBC4046S	BT40-MD40F-60	46	58	130	70	31	22	40	1	0.6	0.7
	DBC4046S	BT40-MD40F-110R	46	58	180	70	60	22	40	2	0.6	0.7
	DBC4046S	BT40-MD40F-115	46	58	185	70	83	22	40	1	0.6	0.7
	DBC5058S	BT40-MD50F-105	58	74	185	80	73	28	50	1	1.1	1.2
	DBC6374S	BT40-MD63F-64	74	94	154	90	37	36	63	1	2.0	2.2
	DBC6374S	BT40-MD63F-110	74	94	200	90	83	36	63	1	2.0	2.2
	DBC6374S	BT40-MD63F-135	74	94	225	90	108	36	63	1	2.0	2.2
	DBC8094S	BT40-MD80F-100	94	120	200	100	73	45	80	1	3.5	3.7

• In the above table, the Arbor Model No. is an example model no. and able to adjust the depth of boring with a combination of MD arbors and extension bars. For more details, see the MD arbor page.

- DBC2528S : CCMT0602□□
- DBC3235S : CCMT0602□□
- DBC4046S : CCMT09T3□□
- DBC5058S : CCMT09T3□□
- DBC6374S : CCMT1204□□
- DBC8094S : CCMT1204□□



BT-DBC

Balance cut tool(Rough Boring)



MAS 403-BT C 28 175 Boring

Shank Coolant System MIN Range MAX Range Boring

Fig.1

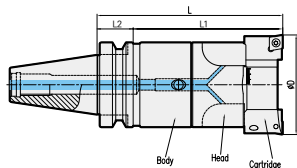
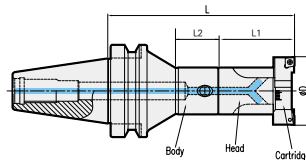
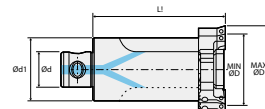


Fig.2



Head



C Internal coolant system installed.

※ Red : Main component Blue : For separate purchase

• For more information on MD arbor, see **126p**

• For more information on the applicable insert, see **159p**

• For more information on the related parts, see **158p**

Model No.	Boring range(ØD)		L	L1	L2	Ød	Ød1	fig	kg (Head weight)	kg (Head package weight)	
	Head model no.	Arbor Model No.									Min.
DBC2528S	BT50-MD25F-105	28	35	165	60	62	14	25	1	0.3	0.3
DBC2528S	BT50-MD25F-120R	28	35	185	60	40	14	25	2	0.3	0.3
DBC3235S	BT50-MD32F-110	35	46	175	65	67	18	32	1	0.4	0.4
DBC3235S	BT50-MD32F-115R	35	46	180	65	45	18	32	2	0.4	0.4
DBC3235S	BT50-MD32F-235R	35	46	300	65	115	18	32	2	0.4	0.4
DBC4046S	BT50-MD40F-60	46	58	130	70	22	22	40	1	0.6	0.7
DBC4046S	BT50-MD40F-195	46	58	265	70	152	22	40	1	0.6	0.7
DBC4046S	BT50-MD40F-230R	46	58	300	70	180	22	40	2	0.6	0.7
DBC5058S	BT50-MD50F-125	58	74	205	80	82	28	50	1	1.1	1.2
DBC5058S	BT50-MD50F-225	58	74	305	80	182	28	50	1	1.1	1.2
DBC5058S	BT50-MD50F-250R	58	74	330	80	81	28	50	2	1.1	1.2
DBC6374S	BT50-MD63F-75	74	94	165	90	35	36	63	1	2.0	2.2
DBC6374S	BT50-MD63F-130	74	94	220	90	87	36	63	1	2.0	2.2
DBC6374S	BT50-MD63F-195	74	94	285	90	152	36	63	1	2.0	2.2
DBC6374S	BT50-MD63F-230	74	94	320	90	187	36	80	1	2.0	2.2
DBC8094S	BT50-MD80F-75	94	120	175	100	36	36	80	1	3.5	3.7
DBC8094S	BT50-MD80F-110	94	120	210	100	69	45	80	1	3.5	3.7
DBC8094S	BT50-MD80F-175	94	120	275	100	134	45	80	1	3.5	3.7
DBC120S	BT50-MD80F-175	120	175	275	100	134	45	80	1	4.1	4.4

• In the above table, the Arbor Model No. is an example model no. and able to adjust the depth of boring with a combination of MD arbors and extension bars. For more details, see the MD arbor page.

- DBC2528S : CCMT0602□□
- DBC3235S : CCMT0602□□
- DBC4046S : CCMT09T3□□
- DBC5058S : CCMT09T3□□
- DBC6374S : CCMT1204□□
- DBC8094S : CCMT1204□□



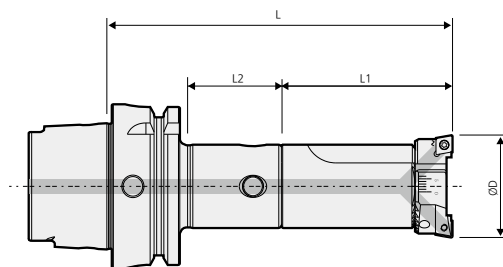
HSK-DBC

Balance cut tool (Modular type)

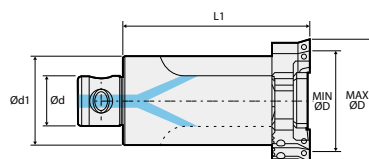


DIN 69893-1	C	28	94	
Shank	Coolant System	MIN Range	MAX Range	Boring

Fig.1



Head.1



C Internal coolant system is optional.

※ Red : Main component Blue : For separate purchase

- For more information on MD arbor, see **126p**.
- For more information on the applicable insert, see **159p**.
- For more information on the related parts, see **158p**.

HSK63A	Model No.		Boring range(ØD)		L	L1	L2	Ød	Ød1	kg (Head weight)	kg (Head package weight)
	Head model no.	Arbor Model No.	Min.	Max.							
	DBC2528S	HSK63A-MD25F-60	28	35							
DBC3235S	HSK63A-MD32F-65	35	46	130	65	36	18	32	0.4	0.4	
DBC4046S	HSK63A-MD40F-70	46	58	140	70	41	22	40	0.6	0.7	
DBC5058S	HSK63A-MD50F-85	58	74	165	80	58	28	50	1.1	1.2	
DBC6374S	HSK63A-MD63F-95	74	94	185	90	69	36	63	2.0	2.2	

• In the above table, the Arbor Model No. is an example model no. and able to adjust the depth of boring with a combination of MD arbors and extension bars. For more details, see the MD arbor page.

- DBC2528S : CCMT0602□□
- DBC3235S : CCMT0602□□
- DBC4046S : CCMT09T3□□
- DBC5058S : CCMT09T3□□
- DBC6374S : CCMT1204□□
- DBC8094S : CCMT1204□□

For separate purchase

Internal coolant system	
-------------------------	--

Classification by shank	
HSK50	HSK50A-CNS
HSK63	HSK63A-CNS
HSK100	HSK100A-CNS



SK-DBC

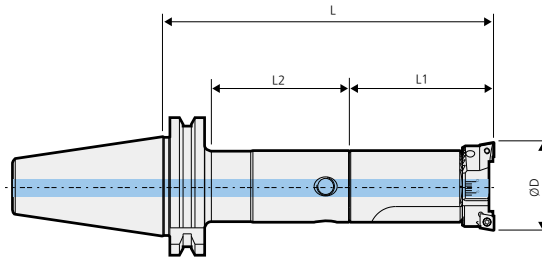
Balance cut tool (Modular type)



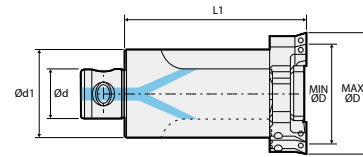
DIN69871
-1A/B
C
28
94
 Boring

Shank Coolant System MIN Range MAX Range Boring

Fig.1



Head.1



C Internal coolant system installed.

※ Red : Main component Blue : For separate purchase

- For more information on MD arbor, see 126p
- For more information on the applicable insert, see 159p
- For more information on the related parts, see 158p

	Model No.		Boring range(ØD)		L	L1	L2	Ød	Ød1	Fig	kg (Head weight)	kg (Head package weight)
	Head model no.	Arbor Model No.	Min.	Max.								
SK40	DBC2528S	SK40-MD25F-80R	28	35	140	60	22	14	25	2	0.3	0.3
	DBC3235S	SK40-MD32F-115R	35	46	180	65	36	18	32	2	0.4	0.4
	DBC4046S	SK40-MD50F-75	46	58	145	70	55	28	50	1	0.6	0.7
	DBC5058S	SK40-MD50F-100	58	74	180	80	80	28	50	1	1.1	1.2
	DBC6374S	SK40-MD63F-70	74	94	160	90	70	36	63	1	2.0	2.2
SK50	DBC2528S	BT50-MD25F-80R	28	35	140	60	22	14	25	2	0.3	0.3
	DBC2528S	BT50-MD25F-105R	28	35	165	60	22	14	25	2	0.3	0.3
	DBC3235S	BT50-MD32F-110	35	46	175	65	87	18	32	1	0.4	0.4
	DBC3235S	BT50-MD32F-110R	35	46	175	65	36	18	32	2	0.4	0.4
	DBC4046S	SK50-MD40F-100	46	58	170	70	75	22	40	1	0.6	0.7
	DBC4046S	SK50-MD40F-145	46	58	215	70	120	22	40	1	0.6	0.7
	DBC4046S	SK50-MD40F-220R	46	58	290	70	83	22	40	2	0.6	0.7
	DBC5054S	BT50-MD50F-125R	58	74	205	80	60	28	50	2	1.1	1.2
	DBC5054S	BT50-MD50F-240R	58	74	320	80	125	28	50	2	1.1	1.2
	DBC6374S	BT50-MD63F-75	74	94	165	90	52	36	63	1	2.0	2.2
	DBC6374S	BT50-MD63F-130	74	94	220	90	107	36	63	1	2.0	2.2
	DBC6374S	BT50-MD63F-230R	74	94	320	90	149	36	63	2	2.0	2.2
	DBC8094S	BT50-MD80F-95	94	120	195	100	75	45	80	1	3.5	3.7
	DBC8094S	BT50-MD80F-150	94	120	250	100	130	45	80	1	3.5	3.7
	DBC120S	BT50-MD80F-150	120	175	250	100	95	45	80	1	4.1	4.4

• In the above table, the Arbor Model No. is an example model no. and able to adjust the depth of boring with a combination of MD arbors and extension bars. For more details, see the MD arbor page.

- DBC2528S : CCMT0602□□
- DBC3235S : CCMT0602□□
- DBC4046S : CCMT09T3□□
- DBC5058S : CCMT09T3□□
- DBC6374S : CCMT1204□□
- DBC8094S : CCMT1204□□



DBCA/DBC SPARE PART

Balance cut tool related parts



Main components

DBCA

Spare Part

TYPE	Main components								
	Head	Spring pin	Wrench bolt	Wrench	Cartridge	Set screw	Wrench	Clamp screw	Torx wrench
Head Set									
DBCA3238S	DBCA2528	SP0308	BX0420	LW-3	BCC28-EC	BT0308	LW-1.5	BFTX02506N	TRX8
DBCA3238S	DBCA3238	SP0410	BX0525	LW-4	BCC38-EC	BT0310	LW-1.5	BFTX02506M	TRX8
DBCA5054S	DBCA5054	SP0616	BX0630	LW-5	BCC54-EC	BT0414	LW-2	BFTX0407N	TRX15
DBCA6374S	DBCA6374	SP0818	BX0635	LW-5	BCC74-EC	BT0520	LW-2.5	BFTX0511N	TRX20
DBCA80100S	DBCA80100	SP1020	BX0840	LW-6	BCC100-EC	BT0625	LW-3	BFTX0511N	TRX20

DBC

Spare Part


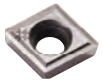



TYPE	Main components								
	Head	Spring pin	Wrench bolt	Wrench	Cartridge	Set screw	Wrench	Clamp screw	Torx wrench
Head Set									
DBC2528S	DBC2528	SP0308	BX0416	LW-3	BCC28	BT0306	LW-1.5	FTKA02565	TRX7
DBC3235S	DBC3235	SP0410	BX0516	LW-4	BCC35	BT0308	LW-1.5	FTKA02565	TRX7
DBC4046S	DBC4046	SP0516	BX0620	LW-5	BCC46	BT0408	LW-2	FTNA0408	TRX15
DBC5058S	DBC5058	SP0616	BX0620	LW-5	BCC58	BT0412	LW-2	FTNA0408	TRX15
DBC6374S	DBC6374	SP0818	BX0830	LW-6	BCC74	BT0516	LW-2.5	BFTX0511N	TRX20
DBC8094S	DBC8094	SP1020	BX1035	LW-8	BCC94	BT0620	LW-3	BFTX0511N	TRX20
DBC120S	DBC120N	SP1020	BX0830	LW-6	BCC120	BT0830	LW-4	BFTX0511N	TRX20



DBCA/DBC SPARE PART

Balance cut tool related parts

For separate purchase

Insert Part		GRADE	Workpiece	CUTTING	Maker
 CCMT0602□□	Coated : AC8010P	Steel, Alloy Steel, Cast iron	general	SEI(SUMITOMO)	
	Coated : AC8025P	Steel, Alloy Steel			
	Coated : AC6030M	Stainless Steel			
	Cermet : T1500A	Steel, Cast iron	finishing ~ general		
	Coated : NC3015, NC3020	Steel, Alloy Steel	general		KORLOY
	Coated : NC315K	Cast iron			
Coated : PC9030	Stainless Steel				
 CCGT0602□□	Coated : AC5025S	Stainless Steel	general	SEI(SUMITOMO)	
	Cermet : T1500A, T3000Z	Steel, Cast iron	finishing ~ general		
	Coated : NC3020	Steel, Alloy Steel	general	KORLOY	
	W.C : H01	Aluminium	finishing ~ general		
 CCMT09T3□□	Coated : AC8015P	Steel, Alloy Steel, Cast iron	general	SEI(SUMITOMO)	
	Coated : AC8025P	Steel, Alloy Steel			
	Coated : AC4015K	Cast iron			
	Coated : AC6030M	Stainless Steel	finishing ~ general		
	Cermet : T1500A	Steel, Cast iron			
	Coated : NC3015, NC3020	Steel, Alloy Steel			
	Coated : NC315K	Cast iron			general
Coated : PC9030	Stainless Steel				
 CCGT09T3□□	Coated : AC5015S	Stainless Steel	general	SEI(SUMITOMO)	
	Cermet : T1500A	Steel, Cast iron	finishing ~ general		
	W.C : H01	Aluminium	general	KORLOY	
	Coated : PC9030	Stainless Steel			
	W.C : H01	Aluminium			finishing ~ general
 CCMT1204□□	Coated : AC8025P	Steel, Alloy Steel	general		SEI(SUMITOMO)
	Cermet : T1500A	Steel, Cast iron	finishing ~ general		
	Coated : NC3015, NC3020	Steel, Alloy Steel	general	KORLOY	
	Coated : NC315K	Cast iron			
Coated : PC9030	Stainless Steel	finishing ~ general			
CCGT1204□□	W.C : H01		Aluminium		

- There are a range of grades and chip breakers to choose from according to usage.
- The cartridge for CNMG1204□□ is different from the cartridge for CCMT1204□□ in terms of Model No.

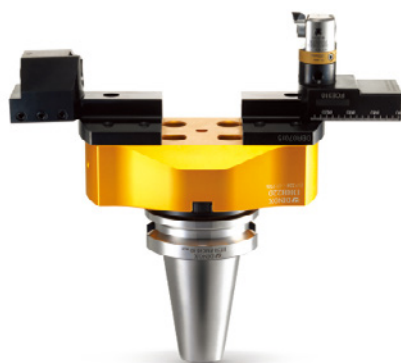


TBCA NEW

Wide Diameter Boring system



C	AL	0	631	
Coolant System	Material	MIN Range	MAX Range	Boring



Features

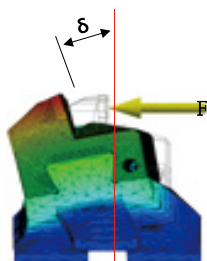
- Convenience in use simultaneously (available both inside and outside)
- Broad boring diameter and range
- Rough / Finishing boring with replaceable cartridge and common rail
- Boring range for outer diameter: $\varnothing 0\text{--}\varnothing 395$
- Boring range for inner diameter: $\varnothing 130\text{--}\varnothing 631$

NAMING	BODY			HEAD SET		
	BT50	FMC40	85	TBC	130	A
	Spindle	Facemill arbor	length	Balance cut tool	Minimum Boring Range	Advance

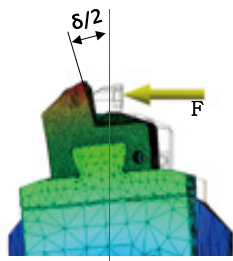
Main Features

Reinforced rigidity

- 50% less moment strain (versus the conventional product of DINE)



TBC460 (old type)



TBC460A (new type)

Lightweight design (HEADSET)

- BCC(Cartridge)+DBR(Bridge)+DBB(Rail)

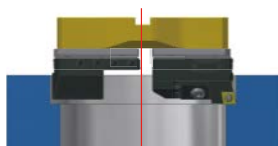


TBC130A	TBC175A	TBC220A	TBC265A
4.2Kg	5.6Kg	6.6Kg	7.5Kg
TBC310A	TBC385A	TBC460A	TBC535A
9.5Kg	11.6Kg	14Kg	16Kg

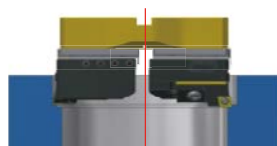
APPLICATION



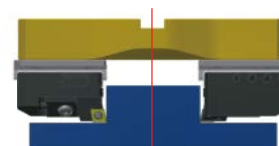
Twin edge boring



Single edge boring



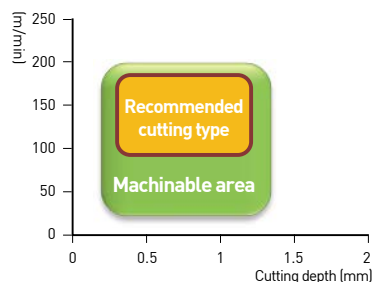
Step boring



Outside boring

Performance test

Product	Workpiece		Boring diameter (Depth of cutting)	Results
	Product name	Material	mm	Machining
Conventional tool of DINE	Housing	Cast iron	$\varnothing 465$ (Rd=7)	<ul style="list-style-type: none"> · Vibration occurred · Insert damaged in the machining process · Scratched surface of workpieces
TBC460A Applicable insert CNMG19	Housing	QT400	$\varnothing 508\text{--}527$ (Rd=10)	<ul style="list-style-type: none"> · No chattering · No vibration found · Goal of accuracy achieved · Normal chip discharged





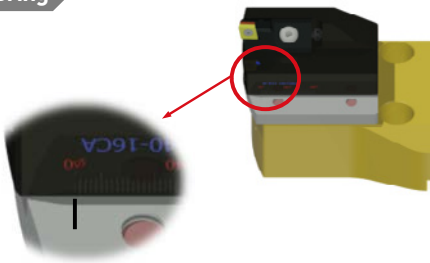
TBCA NEW

Wide Diameter Boring system

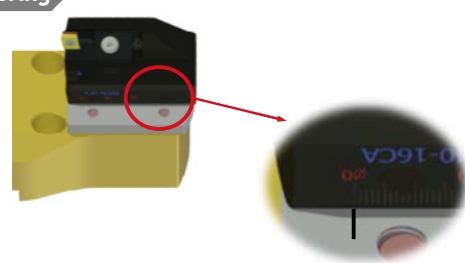


Convenience

Inner boring

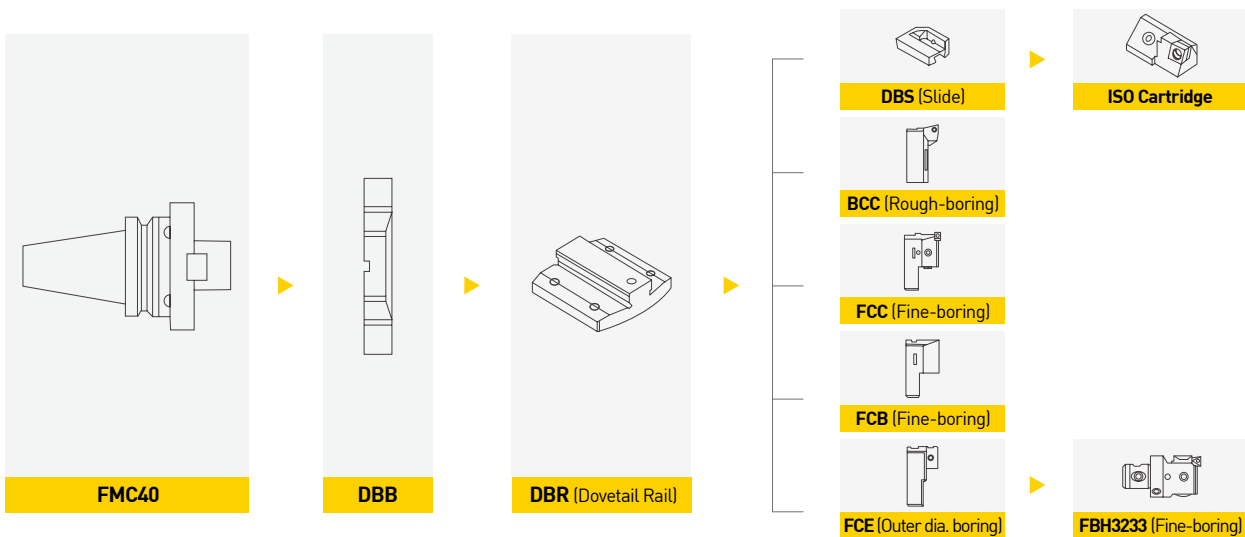


Outer boring

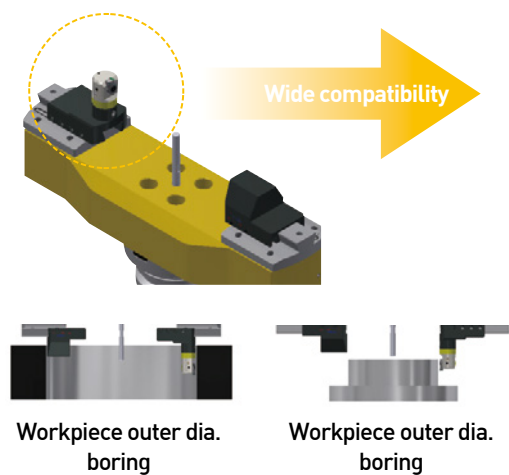


- Inner boring and outer boring can be performed by easily changing the cartridge direction
- With the scale marking on the rail, the boring diameter can be set easily.

Boring system map



Wide compatibility



	IMAGES	List of clamping parts	Cutting type
Outer dia. boring		FBH3233B+FCE310+FCB310	Finishing boring
		DBCA3235S + FCE310 + FCB310	Rough boring
Inner dia. boring		DBS□□ -□□CA+SCGCL16C-1A2	Rough boring
		FCC310	Finishing boring
		BCC1354	Rough boring

※ TBC310A in case

Chuck

Arbor / Modular

Boring tool

Angular head

cBN/PCD

Smart factory

TAUMAX

OTHER



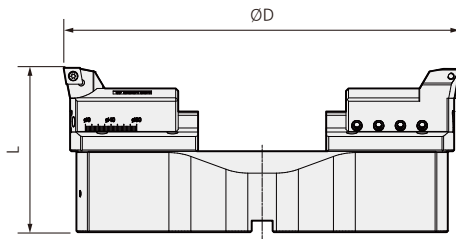
TBCA NEW

Wide Diameter Boring system

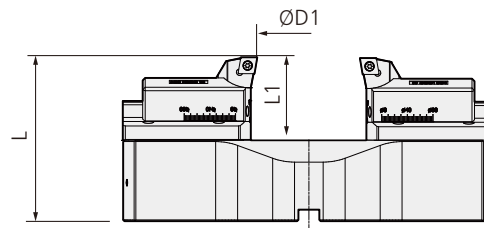


MAS 403-BT	C	AL	130	615	
Shank	Coolant System	Material	MIN Range	MAX Range	Boring

Inside Boring



Outside Boring



C Internal coolant system is optional.

※ Red : Main component Blue : For separate purchase

※ The FMC Arbor are sold individually.

• For more information on the product features, see 160p.

• For more information on FMC arbor, see 122p.

FMC Arbor (Individual order)	Kg	Twin Edge Boring for Roughing							Kg
		TBC Head set (Rail+Cartridge (Main))	L	Boring range					
				Inside Boring		Outside Boring		L1	
Min.	Max.	Min.	Max.						
BT50-FMC40-50	4.6	TBC130A(DBR130+BCC1348+BCC1348)	108	130	180	0	35	65	3.8
BT50-FMC40-50	4.6	TBC175A(DBR175+BCC1348+BCC1348)	113	175	225	0	75	65	5.2
BT50-FMC40-50	4.6	TBC220A(DBR07015+BCC1348+BCC1348)	118	220	270	60	124	65	7.3
BT50-FMC40-50	4.6	TBC265A(DBR07015+BCC1348+BCC1348)	123	265	315	64	174	65	7.3
BT50-FMC40-50	4.6	TBC310A(DBR10015+BCC1345+BCC1345)	128	310	390	79	159	65	9.7
BT50-FMC40-50	4.6	TBC385A(DBR10015+BCC1354+BCC1345)	133	385	465	153	233	65	11.8
BT50-FMC40-50	4.6	TBC460A(DBR10015+BCC1354+BCC1345)	138	460	540	229	309	65	14.3
BT50-FMC40-50	4.6	TBC535A(DBR10015+BCC1354+BCC1345)	143	535	615	303	383	65	16.4

Head set	Bridge	Rail	For separate purchase		
			Cartridge	Arbor	Pin
TBC130A	DBB130	DBR130	BCC1348S	BT50-FMC40-50	PN1080
TBC175A	DBB175	DBR175	BCC1348S	BT50-FMC40-50	PN1080
TBC220A	DBB220	DBR07015	BCC1348S	BT50-FMC40-50	PN1080
TBC265A	DBB265	DBR07015	BCC1348S	BT50-FMC40-50	PN1080
TBC310A	DBB310	DBR10015	BCC1354S	BT50-FMC40-50	PN1080
TBC385A	DBB385	DBR10015	BCC1354S	BT50-FMC40-50	PN1080
TBC460A	DBB460	DBR10015	BCC1354S	BT50-FMC40-50	PN1080
TBC535A	DBB535	DBR10015	BCC1354S	BT50-FMC40-50	PN1080



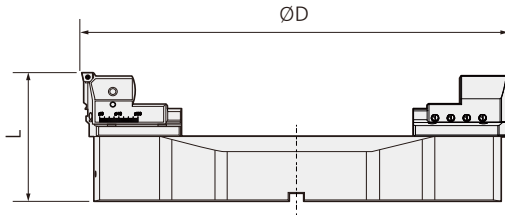
TBCA NEW

Wide Diameter Boring system

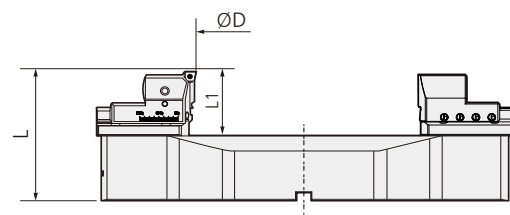


MAS 403-BT	C	AL	130	615	Boring
Shank	Coolant System	Material	MIN Range	MAX Range	Boring

Inside Boring



Outside Boring



C Internal coolant system is optional.

※ Red, Green : Main component Blue : For separate purchase
 ※ The FMC Arbor and head set are products for an individual order.

• For more information on the product features, see **160p**

• For more information on FMC arbor, see **122p**

FMC Arbor (Individual order)	Kg	Single Edge Boring for Roughing							Kg
		TBC Head set (Rail+Cartridge (Separate sale))	L	Boring range					
				Inside Boring		Outside Boring			
Min.	Max.	Min.	Max.	L1					
BT50-FMC40-50	4.6	TBC130A(DBR130+FCC130+FCB130+FBB33N)	101	130	180	37	37	72	4.4
BT50-FMC40-50	4.6	TBC175A(DBR175+FCC130+FCB130+FBB33N)	106	175	225	80	80	72	5.7
BT50-FMC40-50	4.6	TBC220A(DBR07015+FCC130+FCB130+FBB33N)	111	220	270	173	173	72	7.8
BT50-FMC40-50	4.6	TBC265A(DBR07015+FCC130+FCB130+FBB33N)	116	265	315	176	176	72	7.9
BT50-FMC40-50	4.6	TBC310A(DBR10015+FCC310+FCB310+BB33N)	121	310	390	155.5	155.5	72	10.1
BT50-FMC40-50	4.6	TBC385A(DBR10015+FCC310+FCB310+FBB33N)	126	385	465	229.5	229.5	72	12.2
BT50-FMC40-50	4.6	TBC460A(DBR10015+FCC310+FCB310+FBB33N)	131	460	540	305.5	305.5	72	14.7
BT50-FMC40-50	4.6	TBC535A(DBR10015+FCC310+FCB310+FBB33N)	136	535	615	379.5	379.5	72	16.7

Head set	Bridge	Rail	For separate purchase					Pin
			Cartridge	Bite	Balance block	Arbor		
TBC130A	DBB130	DBR130	FCC130	FBB130△□□	FCB130	BT50-FMC40-50	PN1080	
TBC175A	DBB175	DBR175	FCC130	FBB130△□□	FCB130	BT50-FMC40-50	PN1080	
TBC220A	DBB220	DBR07015	FCC130	FBB130△□□	FCB130	BT50-FMC40-50	PN1080	
TBC265A	DBB265	DBR07015	FCC130	FBB130△□□	FCB130	BT50-FMC40-50	PN1080	
TBC310A	DBB310	DBR10015	FCC310	FBB130△□□	FCB310	BT50-FMC40-50	PN1080	
TBC385A	DBB385	DBR10015	FCC310	FBB130△□□	FCB310	BT50-FMC40-50	PN1080	
TBC460A	DBB460	DBR10015	FCC310	FBB130△□□	FCB310	BT50-FMC40-50	PN1080	
TBC535A	DBB535	DBR10015	FCC310	FBB130△□□	FCB310	BT50-FMC40-50	PN1080	



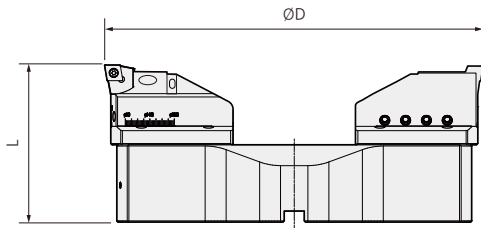
TBCA NEW

Wide Diameter Boring system

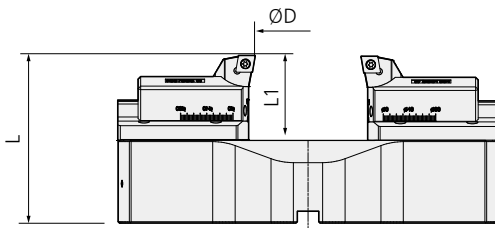


MAS 403-BT	C	AL	130	615	Boring
Shank	Coolant System	Material	MIN Range	MAX Range	Boring

Inside Boring



Outside Boring



C Internal coolant system is optional.

※ Red, Green : Main component Blue : For separate purchase

※ The FMC Arbor and head set are products for an individual order.

• For more information on the product features, see **160p**.

• For more information on FMC arbor, see **122p**.

FMC Arbor (Individual order)	Kg	Step Boring for Roughing							Kg
		TBC Head set (Rail+Cartridge (Separate sale))	L	Boring range					
				Inside Boring		Outside Boring		L1	
Min.	Max.	Min.	Max.	L1					
BT50-FMC40-50	4.6	TBC130A(DBR130+DBS25-□□CA+SCGCL16CA-12)	108	130	180	0	13.5	65	4.3
BT50-FMC40-50	4.6	TBC175A(DBR175+DBS25-□□CA+SCGCL16CA-12)	113	175	225	0	55	65	5.7
BT50-FMC40-50	4.6	TBC220A(DBR07015+DBS25-□□CA+SCGCL16CA-12)	118	220	270	64	128	65	7.8
BT50-FMC40-50	4.6	TBC265A(DBR07015+DBS25-□□CA+SCGCL16CA-12)	123	265	315	68	118	65	7.9
BT50-FMC40-50	4.6	TBC310A(DBR10015+DBS40-□□CA+SCGCL16CA-12)	128	310	390	109	159	65	10.2
BT50-FMC40-50	4.6	TBC385A(DBR10015+DBS40-□□CA+SCGCL16CA-12)	133	385	465	183	233	65	12.3
BT50-FMC40-50	4.6	TBC460A(DBR10015+DBS40-□□CA+SCGCL16CA-12)	138	460	540	259	309	65	14.8
BT50-FMC40-50	4.6	TBC535A(DBR10015+DBS40-□□CA+SCGCL16CA-12)	143	535	615	33	383	65	16.9

Head set	Bridge	Rail	Cartridge	For separate purchase				
				Arbor	Slide	Cartridge	Plate	Pin
TBC130A	DBB130	DBR130	BCC1348S	BT50-FMC40-50	DBS25-16CA DBS25-20CA DBS25-25CA	ISO Cartridge	ISO Cartridge Plates	PN1080
TBC175A	DBB175	DBR175	BCC1348S					
TBC220A	DBB220	DBR07015	BCC1348S					
TBC265A	DBB265	DBR07015	BCC1348S					
TBC310A	DBB310	DBR10015	BCC1354S					
TBC385A	DBB385	DBR10015	BCC1354S					
TBC460A	DBB460	DBR10015	BCC1354S					
TBC535A	DBB535	DBR10015	BCC1354S					



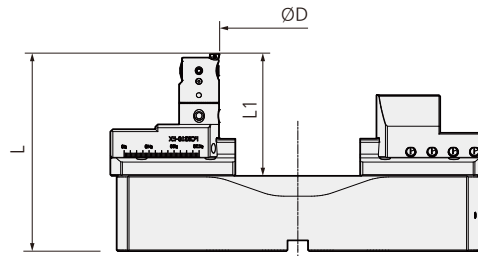
TBCA NEW

Wide Diameter Boring system



MAS 403-BT	C	AL	130	535	Boring
Shank	Coolant System	Material	MIN Range	MAX Range	Boring

Outside Boring



C Internal coolant system is optional.

※ Red, Green : Main component Blue : For separate purchase

※ The FMC Arbor and head set are products for an individual order.

• For more information on the product features, see **160p**

• For more information on FMC arbor, see **122p**

FMC Arbor (Individual order)	Kg	Outside Boring for Finishing					Kg
		TBC Head set (Rail+Cartridge (Separate sale))	L	Boring range Outside Boring			
				Min.	Max.	L1	
BT50-FMC40-50	4.6	TBC130A(DBR130+FCB130+FCE130+FBH3233B+FBB33N)	145	0	39	102	5.2
BT50-FMC40-50	4.6	TBC175A(DBR175+FCB130+FCE130+FBH3233B+FBB33N)	150	0	84	102	6.5
BT50-FMC40-50	4.6	TBC220A(DBR07015+FCB130+FCE130+FBH3233B+FBB33N)	155	26	180	102	8.7
BT50-FMC40-50	4.6	TBC265A(DBR07015+FCB130+FCE130+FBH3233B+FBB33N)	160	26	180	102	8.7
BT50-FMC40-50	4.6	TBC310A(DBR10015+FCB310+FCE310+FBH3233B+FBB33N)	165	16	170	102	11
BT50-FMC40-50	4.6	TBC385A(DBR10015+FCB310+FCE310+FBH3233B+FBB33N)	170	90	244	102	13.1
BT50-FMC40-50	4.6	TBC460A(DBR10015+FCB310+FCE310+FBH3233B+FBB33N)	175	166	318	102	15.6
BT50-FMC40-50	4.6	TBC535A(DBR10015+FCB310+FCE310+FBH3233B+FBB33N)	180	240	394	102	17.7

Head set	Bridge	Rail	For separate purchase				
			Arbor	Slide	B/B	Head	Pin
TBC130A	DBB130	DBR130	BT50-FMC40-50	FCE130	FCB130	FBH3233B	PN1080
TBC175A	DBB175	DBR175					
TBC220A	DBB220	DBR07015					
TBC265A	DBB265	DBR07015					
TBC310A	DBB310	DBR10015					
TBC385A	DBB385	DBR10015					
TBC460A	DBB460	DBR10015					
TBC535A	DBB535	DBR10015	FCE310	FCB310			

※ B/B : Balance Block



TBC

Balance cut tool for Rough boring



C
130
540

Coolant System MIN Range MAX Range Boring



Features

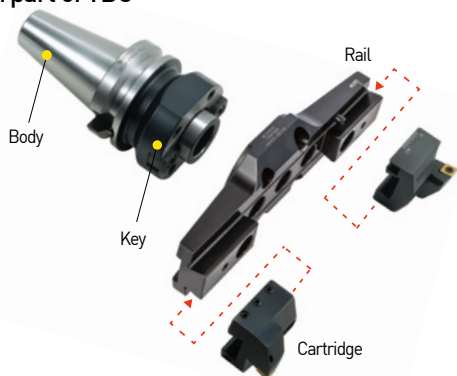
- Broad boring diameter and range
 - Wide Boring Range : Ø130 ~ Ø540mm
- Structurally stable enough to resist cutting load
 - Provides strong cutting performance based on the precision grinding dovetail method
- Can perform fine boring operation by changing boring head cartridges
 - Compatible boring head and rail as they are in the same structure
- Various cartridge tip angles - cartridge fore end angles 15° and 45° selectable
- Internal coolant pin installation - easy to install/remove and 6-way injection coolant pin part available

NAMING

BT50	-	FMD50	-	85	+	TBC	130S
Spindle		Wide dia. holder		Depth		Wide dia.(Rough boring) Min. boring dia.	Head set
		Holder(option)					

Structure and main features of TBC Boring Tool

Names of each part of TBC



Cartridge : BCC1348
 Insert : CCMT1204□□
 CNMG1204□□



Rail : TBR□□
 Weight reduced and space for chip discharge secured by removing the side part

Boring Range of TBC Boring Tool

Model No.	Dia(Ø) Boring diameter		Head set	Insert
	min	max		
TBC130	130	180	TBC130S(TBR130+BCC1348+BCC1348)	CCMT1204□□
TBC175	175	225	TBC175S(TBR175+BCC1348+BCC1348)	CCMT1204□□
TBC220	220	270	TBC220S(TBR220+BCC1348+BCC1348)	CCMT1204□□
TBC265	265	315	TBC265S(TBR265+BCC1348+BCC1348)	CCMT1204□□
TBC310	310	390	TBC310S(TBR310+BCC1348+BCC1348)	CCMT1204□□
TBC385	385	465	TBC385S(TBR310+BCC1348+BCC1348)	CCMT1204□□
TBC460	460	540	TBC460S(TBR460+BCC1348+BCC1348)	CCMT1204□□



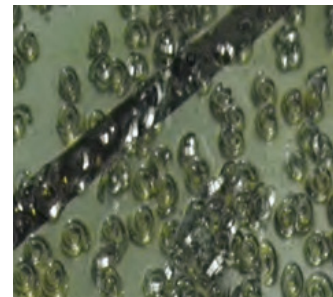
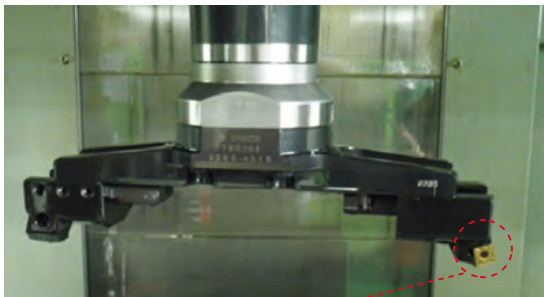
TBC

Balance cut tool for Rough boring



Application example 1 of TBC Boring Tool

Chip shapes by cartridge tip angle diversification



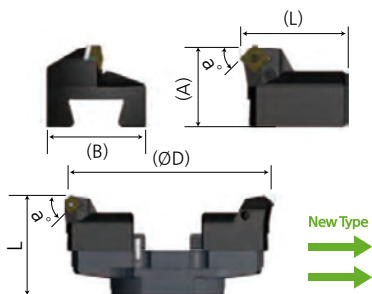
Conventional type

Angle adjustment type



- In the case of conventional type products : thick chips and change by heat
- In the case of "angle adjustment cartridge" : thin chips and no color change

Various cartridges selectable(15°, 45°)



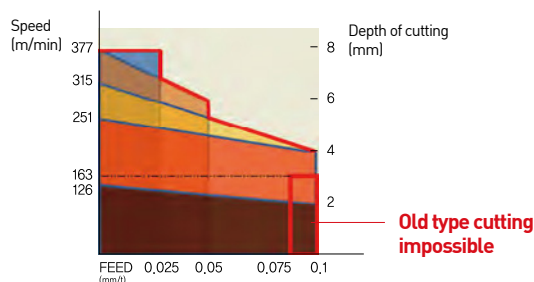
CARTRIDGE	(A)	(B)	(L)	(α°)	Applicable insert
BCC1348	50	60	64.5	1°	CCMT0602□□
BCC1348-SN15				15°	SNMG1204□□
BCC1348-SN45				45°	SNMG1204□□
BCC1354	50	60	89.5	0°	CCMT0602□□
BCC1354-SN15				15°	SNMG1204□□
BCC1354-SN45				45°	SNMG1204□□

Application example 2 of Boring Tool

- **Equipment** : straight type machining center
- **Workpiece material** : S45C
- **Tool used** : BT50-FMD50-155 + TBC310S
- **Insert** : CCMT120408
- **Cutting conditions** : V=200m/min, RPM=163, F=0.1/per knife, d=2mm



Surface roughness effect





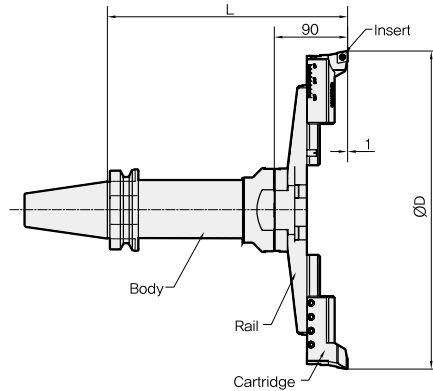
BT-TBC

Balance cut tool for Rough boring



MAS
403-BT
C
130
540
Boring

Shank Coolant System MIN Range MAX Range Boring



C This product does not support the internal coolant system.

※ FMD Arbor and head set are products for an individual order.

※ Red : Main component Blue : For separate purchase

- For more information on the product features, see **166p**
- For more information on FMD arbor, see **175p**
- For more information on the applicable insert, see **166p**
- For more information on the related parts, see **170p**

	FMD Arbor (Individual order)	Kg (Holder weight)	Rough boring(TBC)				
			TBC Head set (Rail+Cartridge)	L	Boring range(ØD)		Kg (Head weight)
					Min.	Max.	
BT50	BT50-FMD50-85	5.9	TBC130S(TBR130+BCC1348)	175	130	180	3.2
	BT50-FMD50-155	7.9	TBC130S(TBR130+BCC1348)	245	130	180	3.2
	BT50-FMD50-205	9.7	TBC130S(TBR130+BCC1348)	295	130	180	3.2
	BT50-FMD50-255	13.4	TBC130S(TBR130+BCC1348)	345	130	180	3.2
	BT50-FMD50-85	5.9	TBC175S(TBR175+BCC1348)	175	175	225	3.6
	BT50-FMD50-155	7.9	TBC175S(TBR175+BCC1348)	245	175	225	3.6
	BT50-FMD50-205	9.7	TBC175S(TBR175+BCC1349)	295	175	225	3.6
	BT50-FMD50-255	13.4	TBC175S(TBR175+BCC1350)	345	175	225	3.6
	BT50-FMD50-85	5.9	TBC220S(TBR220+BCC1348)	175	220	270	4
	BT50-FMD50-155	7.9	TBC220S(TBR220+BCC1348)	245	220	270	4
	BT50-FMD50-205	9.7	TBC220S(TBR220+BCC1348)	295	220	270	4
	BT50-FMD50-255	13.4	TBC220S(TBR220+BCC1348)	345	220	270	4
	BT50-FMD50-85	5.9	TBC265S(TBR265+BCC1348)	175	265	315	4.2
	BT50-FMD50-155	7.9	TBC265S(TBR265+BCC1348)	245	265	315	4.2
	BT50-FMD50-205	9.7	TBC265S(TBR265+BCC1348)	295	265	315	4.2
	BT50-FMD50-255	13.4	TBC265S(TBR265+BCC1348)	345	265	315	4.2
	BT50-FMD50-85	5.9	TBC310S(TBR310+BCC1345)	175	310	390	5.2
	BT50-FMD50-155	7.9	TBC310S(TBR310+BCC1345)	245	310	390	5.2
	BT50-FMD50-205	9.7	TBC310S(TBR310+BCC1345)	295	310	390	5.2
	BT50-FMD50-255	13.4	TBC310S(TBR310+BCC1345)	345	310	390	5.2
	BT50-FMD50-85	5.9	TBC385S(TBR385+BCC1354)	175	385	465	5.5
	BT50-FMD50-155	7.9	TBC385S(TBR385+BCC1354)	245	385	465	5.5
	BT50-FMD50-205	9.7	TBC385S(TBR385+BCC1354)	295	385	465	5.5
	BT50-FMD50-255	13.4	TBC385S(TBR385+BCC1354)	345	385	465	5.5
	BT50-FMD50-85	5.9	TBC460S(TBR460+BCC1354)	175	460	540	12.5
	BT50-FMD50-155	7.9	TBC460S(TBR460+BCC1354)	245	460	540	12.5
	BT50-FMD50-205	9.7	TBC460S(TBR460+BCC1354)	295	460	540	12.5
	BT50-FMD50-255	13.4	TBC460S(TBR460+BCC1354)	345	460	540	12.5

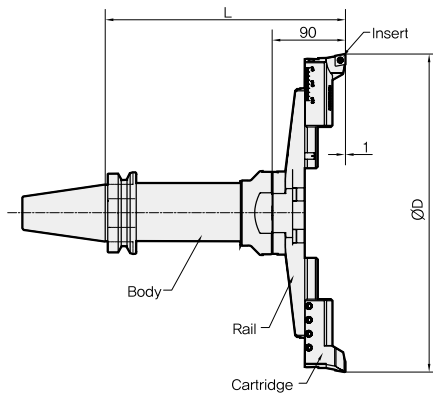


SK-TBC

Balance cut tool for Rough boring



MAS 403-BT	C	130	540	
Shank	Coolant System	MIN Range	MAX Range	Boring



C This product does not support the internal coolant system.
 ※ FMD Arbor and head set are products for an individual order.
 ※ Red : Main component Blue : For separate purchase

- For more information on the product features, see **166p**
- For more information on FMD arbor, see **175p**
- For more information on the applicable insert, see **166p**
- For more information on the related parts, see **170p**

	FMD Arbor (Individual order)	Kg	Boring range(ØD)			Boring range(ØD)	
			TBC Head set(Rail+Cartridge)	L	Kg	Min.	Max.
SK50	SK50-FMD50-155	7.9	TBC130S(TBR130+BCC1348)	252	3.2	130	180
	SK50-FMD50-255	13.4	TBC130S(TBR130+BCC1348)	352	3.2	130	180
	SK50-FMD50-155	7.9	TBC175S(TBR175+BCC1348)	252	3.6	175	225
	SK50-FMD50-255	13.4	TBC175S(TBR175+BCC1350)	352	3.6	175	225
	SK50-FMD50-155	7.9	TBC220S(TBR220+BCC1348)	252	4	220	270
	SK50-FMD50-255	13.4	TBC220S(TBR220+BCC1348)	352	4	220	270
	SK50-FMD50-155	7.9	TBC265S(TBR265+BCC1348)	252	4.2	265	315
	SK50-FMD50-255	13.4	TBC265S(TBR265+BCC1348)	352	4.2	265	315
	SK50-FMD50-155	7.9	TBC310S(TBR310+BCC1345)	252	5.2	310	390
	SK50-FMD50-255	13.4	TBC310S(TBR310+BCC1345)	352	5.2	310	390
	SK50-FMD50-155	7.9	TBC385S(TBR385+BCC1354)	252	5.5	385	465
	SK50-FMD50-255	13.4	TBC385S(TBR385+BCC1354)	352	5.5	385	465
	SK50-FMD50-155	7.9	TBC460S(TBR460+BCC1354)	252	12.5	460	540
	SK50-FMD50-255	13.4	TBC460S(TBR460+BCC1354)	352	12.5	460	540

Chuck

Arbor / Modular

Boring tool

Angular head

cBN/PCD

Smart factory

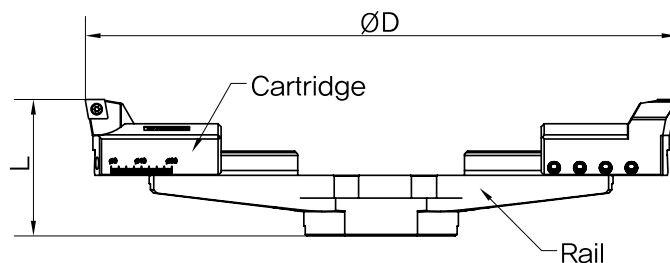
TAUMAX

OTHER



TBC HEAD SET

Balance cut tool for Rough boring



Head set(Main component)			Boring range(ØD)		L	Kg	For separate purchase Insert
Model No.	Rail	Cartridge	Min.	Max.			
TBC130S	TBR130	BCC1348	130	180	90	3.5	CCMT1204□□
TBC175S	TBR175	BCC1348	175	225	90	3.9	CCMT1204□□
TBC220S	TBR220	BCC1348	220	270	90	4.3	CCMT1204□□
TBC265S	TBR265	BCC1348	265	315	90	4.5	CCMT1204□□
TBC310S	TBR310	BCC1345	310	390	90	5.5	CCMT1204□□
TBC385S	TBR385	BCC1345	385	465	90	5.8	CCMT1204□□
TBC460S	TBR460	BCC1345	460	540	90	12.8	CCMT1204□□

※ If CNMG1204□□ insert is used, BCN1348, BCN1354 cartridges can be ordered.



TBC SPARE PART

Balance cut tool for rough boring related parts

Spare Part

TYPE	Main component						
	Rail	Cartridge	Clamp bolt	Clamp bolt	Hexagonal wrench	Clamp screw	Torx wrench
Head Set							
TBC130S	TBR130	BCC1348 (BCN1348)	BX0820	BT0645	LW-3 LW-4 LW-6	BFTX0511N	TRX20
TBC175S	TBR175						
TBC220S	TBR220						
TBC265S	TBR265	BCC1354 (BCN1354)		BT0660			
TBC310S	TBR310						
TBC385S	TBR385						
TBC460S	TBR460						



FBC

Balance cut tool for fine boring



C
130
540
Boring

Coolant System MIN Range MAX Range Boring



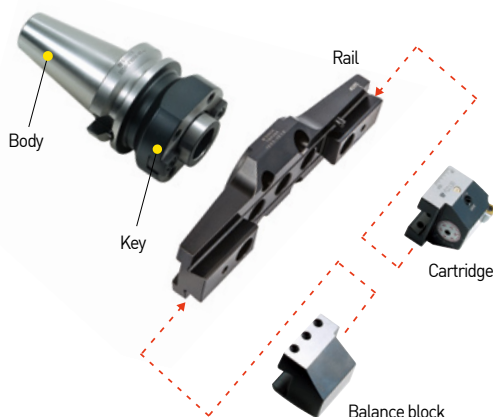
Features

- Broad boring diameter and range
 - Wide Boring Range : $\varnothing 130 \sim \varnothing 540\text{mm}$
- Structurally stable enough to resist cutting load
 - Provides strong cutting performance based on the precision grinding dovetail method
- Can perform fine boring operation by changing boring head cartridges
 - Compatible boring head and rail as they are in the same structure
- Various cartridge tip angles
 - cartridge fore end angles 15° and 45° selectable

NAMING	BT50	-	FMD50	-	85	+	FBC	130S
	Spindle		Wide dia. holder		Depth		Wide dia.(fine-boring)	Min. boring dia.
			Holder(option)					Head set

Structure and main features of FBC Boring Tool

Names of each part of FBC



Cartridge : FCC130
 Insert : CCGT09T3□□
 CCMT1204□□
 TPGT1103□□

Balance block :
 FCB130

Boring range of FBC Boring Tool

Model No.	Dia(∅) boring diameter		Head set	Insert
	min	max		
FBC130	130	180	FBC130S(TBR130+FCC130+FCB130)	FBB130-C09(CCMT09T3□□, CCGT09T3□□) FBB130-C12(CCMT1204□□) FBB130-T11(TPMT1103□□, TPGT1103□□)
FBC175	175	225	FBC175S(TBR175+FCC130+FCB130)	
FBC220	220	270	FBC220S(TBR220+FCC130+FCB130)	
FBC265	265	315	FBC265S(TBR265+FCC130+FCB130)	
FBC310	310	390	FBC310S(TBR310+FCC310+FCB310)	
FBC385	385	465	FBC385S(TBR385+FCC310+FCB310)	
FBC460	460	540	FBC460S(TBR460+FCC310+FCB310)	

Application example of Special FBC Boring Tool

Material	Cutting speed V	RPM	FEED		Cutting depth ∅ (mm)	Boring diameter ∅ (mm)
			(mm/min)	(mm/rev)		
Aluminium	200	48	5	0.1	0.5	$\varnothing 1300$
	200	48	10	0.1	2	$\varnothing 1300$
	500	120	12	0.1	2	$\varnothing 1300$



Chuck

Arbor / Modular

Boring tool

Angular head

cBN/PCD

Smart factory

TAUMAX

OTHER



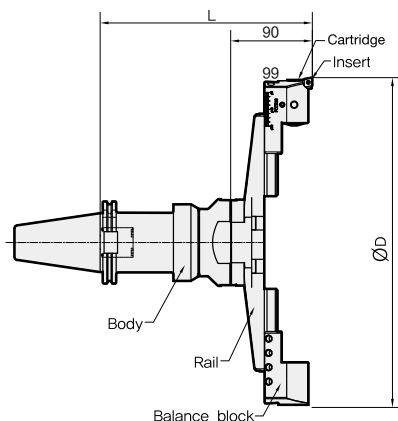
BT-FBC

Balance cut tool for fine boring



MAS 403-BT
C
130
540
Boring

Shank Coolant System MIN Range MAX Range Boring



C This product does not support the internal coolant system.

※ Red : Main component Blue : For separate purchase

※ FMD Arbor and head set are products for an individual order.

※ If BB130-C12bite is used, the minimum boring diameter increases by $\phi 6.7$ mm.

• For more information on the product features, see **171p**

• For more information on FMD arbor, see **175p**

• For more information on FBB bite, see **175p**

• For more information on the related parts, see **174p**

FMD Arbor (Individual order)	Kg (Holder weight)	Rough boring(TBC)					
		TBC Head set (Rail+Cartridge+Balance block)	L	Kg	Boring range(ØD)		
					Min.	Max.	
BT50	BT50-FMD50-85	5.9	FBC130S(TBR130+FCC130+FCB130)	182	3.7	130	180
	BT50-FMD50-155	7.9	FBC130S(TBR130+FCC130+FCB130)	252	3.7	130	180
	BT50-FMD50-205	9.7	FBC130S(TBR130+FCC130+FCB130)	302	3.7	130	180
	BT50-FMD50-255	13.4	FBC130S(TBR130+FCC130+FCB130)	352	3.7	130	180
	BT50-FMD50-85	5.9	FBC175S(TBR175+FCC130+FCB130)	182	4.1	175	225
	BT50-FMD50-155	7.9	FBC175S(TBR175+FCC130+FCB130)	252	4.1	175	225
	BT50-FMD50-205	9.7	FBC175S(TBR175+FCC130+FCB130)	302	4.1	175	225
	BT50-FMD50-255	13.4	FBC175S(TBR175+FCC130+FCB130)	352	4.1	175	225
	BT50-FMD50-85	5.9	FBC220S(TBR220+FCC130+FCB130)	182	4.5	220	270
	BT50-FMD50-155	7.9	FBC220S(TBR220+FCC130+FCB130)	252	4.5	220	270
	BT50-FMD50-205	9.7	FBC220S(TBR220+FCC130+FCB130)	302	4.5	220	270
	BT50-FMD50-255	13.4	FBC220S(TBR220+FCC130+FCB130)	352	4.5	220	270
	BT50-FMD50-85	5.9	FBC265S(TBR265+FCC130+FCB130)	182	4.7	265	315
	BT50-FMD50-155	7.9	FBC265S(TBR265+FCC130+FCB130)	252	4.7	265	315
	BT50-FMD50-205	9.7	FBC265S(TBR265+FCC130+FCB130)	302	4.7	265	315
	BT50-FMD50-255	13.4	FBC265S(TBR265+FCC130+FCB130)	352	4.7	265	315
	BT50-FMD50-85	5.9	FBC310S(TBR310+FCC310+FCB310)	182	5.5	310	390
	BT50-FMD50-155	7.9	FBC310S(TBR310+FCC310+FCB310)	252	5.5	310	390
	BT50-FMD50-205	9.7	FBC310S(TBR310+FCC310+FCB310)	302	5.5	310	390
	BT50-FMD50-255	13.4	FBC310S(TBR310+FCC310+FCB310)	352	5.5	310	390
	BT50-FMD50-85	5.9	FBC385S(TBR385+FCC310+FCB310)	182	5.8	385	465
	BT50-FMD50-155	7.9	FBC385S(TBR385+FCC310+FCB310)	252	5.8	385	465
	BT50-FMD50-205	9.7	FBC385S(TBR385+FCC310+FCB310)	302	5.8	385	465
	BT50-FMD50-255	13.4	FBC385S(TBR385+FCC310+FCB310)	352	5.8	385	465
	BT50-FMD50-85	5.9	FBC460S(TBR460+FCC310+FCB310)	182	12.8	460	540
	BT50-FMD50-155	7.9	FBC460S(TBR460+FCC310+FCB310)	252	12.8	460	540
	BT50-FMD50-205	9.7	FBC460S(TBR460+FCC310+FCB310)	302	12.8	460	540
	BT50-FMD50-255	13.4	FBC460S(TBR460+FCC310+FCB310)	352	12.8	460	540

※ Bite (Insert)

FBB130-CC09 (CCMT09T3□□, CCGT09T3□□) / FBB130-C12 (CCMT1204□□) / FBB130-T11 (TPMT1103□□, TPGT1103□□L)



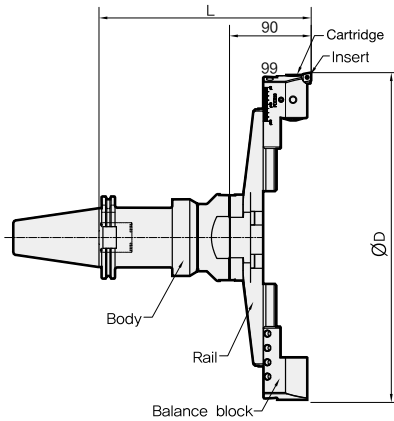
SK-FBC

Balance cut tool for fine boring



DIN69871
-1A/B
C
130
540
Boring

Shank Coolant System MIN Range MAX Range Boring



C This product does not support the internal coolant system.

- ※ Red : Main component Blue : For separate purchase
- ※ FMD Arbor and head set are products for an individual order.
- ※ If BB130-C12bite is used, the minimum boring diameter increases by $\varnothing 6.7$ mm.

- For more information on the product features, see **171p**
- For more information on FMD arbor, see **175p**
- For more information on FBB bite, see **175p**
- For more information on the related parts, see **174p**

	FMD Arbor (Individual order)	Holder(Kg)	Boring range(ØD)			Boring range(ØD)	
			TBC Head set(Rail+Cartridge+Balance block)	L	Kg	Min.	Max.
SK50	BT50-FMD50-155	8	FBC130S(TBR130+FCC130+FCB130)	252	3.8	130	180
	BT50-FMD50-255	11.2	FBC130S(TBR130+FCC130+FCB130)	352	3.8	130	180
	BT50-FMD50-155	8	FBC175S(TBR175+FCC130+FCB130)	252	4.1	175	225
	BT50-FMD50-255	11.2	FBC175S(TBR175+FCC130+FCB130)	352	4.1	175	225
	BT50-FMD50-155	8	FBC220S(TBR220+FCC130+FCB130)	252	4.5	220	270
	BT50-FMD50-255	11.2	FBC220S(TBR220+FCC130+FCB130)	352	4.5	220	270
	BT50-FMD50-155	8	FBC265S(TBR265+FCC130+FCB130)	252	4.7	265	315
	BT50-FMD50-255	11.2	FBC265S(TBR265+FCC130+FCB130)	352	4.7	265	315
	BT50-FMD50-155	8	FBC310S(TBR310+FCC310+FCB310)	252	5.5	310	390
	BT50-FMD50-255	11.2	FBC310S(TBR310+FCC310+FCB310)	352	5.5	310	390
	BT50-FMD50-155	8	FBC385S(TBR385+FCC310+FCB310)	252	5.8	385	465
	BT50-FMD50-255	11.2	FBC385S(TBR385+FCC310+FCB310)	352	5.8	385	465
	BT50-FMD50-155	8	FBC460S(TBR460+FCC310+FCB310)	252	12.8	460	540
	BT50-FMD50-255	11.2	FBC460S(TBR460+FCC310+FCB310)	352	12.8	460	540

※ Bite (Insert)

FBB130-CC09 (CCMT09T3□□, CCGT09T3□□) / FBB130-C12 (CCMT1204□□) / FBB130-T11 (TPMT1103□□, TPGT1103□□L)

Chuck

Arbor / Modular

Boring tool

Angular head

cBN/PCD

Smart factory

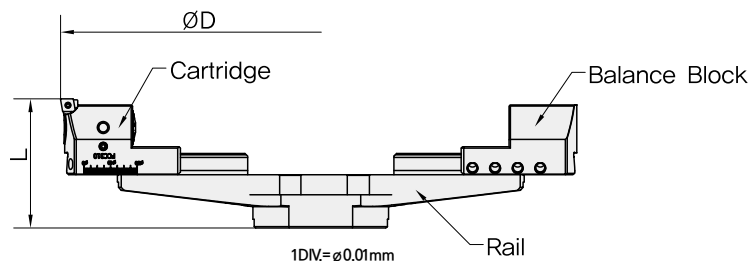
TAUMAX

OTHER



FBC HEAD SET

Balance cut tool for fine boring



Head set(Main component)				Boring range(ØD)		L	Kg	For separate purchase Bite
Model No.	Rail	Cartridge	Balance block	Min.	Max.			
FBC130S	TBR130	FCC130	FCB130	130	180	97	3.8	FBB130-C09 FBB130-C12 FBB130-T11
FBC175S	TBR175	FCC130	FCB130	175	225	97	4.1	
FBC220S	TBR220	FCC130	FCB130	220	270	97	4.5	
FBC265S	TBR26	FCC130	FCB130	265	315	97	4.6	
FBC310S	TBR310	FCC310	FCB310	310	390	97	5.5	
FBC385S	TBR385	FCC310	FCB310	385	465	97	5.8	
FBC460S	TBR460	FCC310	FCB310	460	540	97	12.8	



FBC SPARE PART

Balance cut tool for fine boring related parts

Spare Part							
TYPE	Main component						For separate purchase Bite
	Rail	Cartridge	Clamp bolt	Clamp bolt	Clamp bolt	Hexagonal wrench	
Head Set							
FBC130S	TBR130	FCC130	FCB130	BTF0810 BTF0814	BT0645	LW-3 LW-4	FBB130-C09 FBB130-C12 FBB130-T11
FBC175S	TBR175						
FBC220S	TBR220						
FBC265S	TBR265	FCC310	FCB310		BT0660		
FBC310S	TBR310						
FBC385S	TBR385						
FBC460S	TBR460						



FBB BITE

Balance cut tool for fine boring



Model No.	Insert
FBB130-C09	CCMT09T3□□, CCGT09T3□□
FBB130-C12	CCMT1204□□
FBB130-T11	TPMT1103□□, TPGT1103□□

Chuck

Arbor / Modular

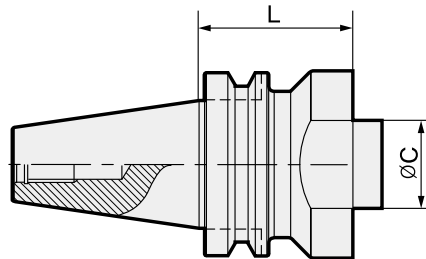
Boring tool

Angular head



BT - FMD

Arbor(Basic Holder)



	Model No.	L	ØC	Kg
SK50, BT50	BT50-FMD50-85	85	50	5.9
	BT50-FMD50-155	155	50	7.9
	BT50-FMD50-205	205	50	9.7
	BT50-FMD50-255	255	50	10.4
	SK50-FMD50-155	155	50	7.9
	SK50-FMD50-255	255	50	10.4

cBN/PCD

Smart factory

TAUMAX

OTHER



BT-SMB

Small micro boring bar



MAS 403-BT	C	Ø6	Ø34	
Shank	Coolant System	MIN Range	MAX Range	Boring

Fig.1

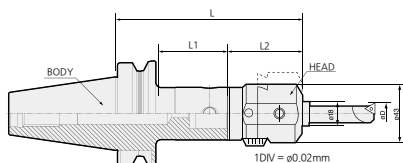
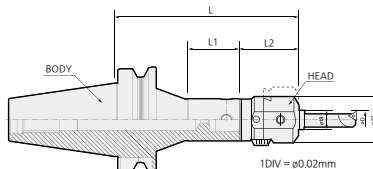
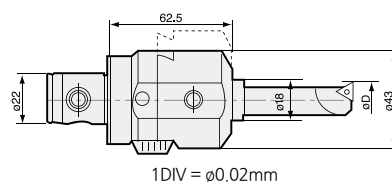


Fig.2



Head



- Adjustment length: 7mm

C This product does not support the internal coolant system.

✘ Red : Main component Blue : For separate purchase

- For more information on MD arbor, see **126p**.

- For more information on BB bite, see **184p**.

- For more information on the related parts, see **183p**.

	Model No.			Boring range(ØD)	L	L1	L2	Fig.	Head weight
	Head model no.	Arbor Model No.	BB bite						
BT30	SMB4022	BT30-MD40F-45	BB18-□(S)	Ø6.0~Ø34.0	107.5	22	62.5	1	0.6
	SMB4022	BT30-MD40F-60	BB18-□(S)	Ø6.0~Ø34.0	122.5	36	62.5	1	0.6
	SMB4022	BT30-MD40F-80	BB18-□(S)	Ø6.0~Ø34.0	142.5	56	62.5	1	0.6
BT40	SMB4022	BT40-MD40F-60	BB18-□(S)	Ø6.0~Ø34.0	122.5	31	62.5	1	0.6
	SMB4022	BT40-MD40F-110R	BB18-□(S)	Ø6.0~Ø34.0	172.5	60	62.5	2	0.6
	SMB4022	BT40-MD40F-115	BB18-□(S)	Ø6.0~Ø34.0	177.5	83	62.5	1	0.6
BT50	SMB4022	BT50-MD40F-60	BB18-□(S)	Ø6.0~Ø34.0	122.5	22	62.5	1	0.6
	SMB4022	BT50-MD40F-195	BB18-□(S)	Ø6.0~Ø34.0	257.5	152	62.5	1	0.6
	SMB4022	BT50-MD40F-230R	BB18-□(S)	Ø6.0~Ø34.0	292.5	180	62.5	2	0.6

BB Bite(For SMB)

Model No.	Boring range(ØD)		Insert	Screw	Kg
	Min	Max			
BB18-7(S)	8	28	TBGT0601□□L	BFTX0204A	0.1
BB18-9(S)	10	30	TBGT0802□□L	BFTX0204A	0.1
BB18-11(S)	12	32	TBGT1103□□L	BFTX0307A	0.1
BB18-13(S)	14	34	TBGT1103□□L	BFTX0307A	0.1
BB18-15(S)	16	36	TBGT1103□□L	BFTX0307A	0.2
BB18-17(S)	18	38	TBGT1103□□L	BFTX0307A	0.2

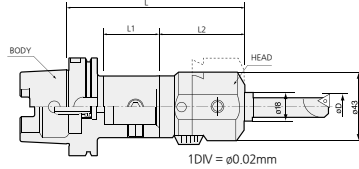


HSK/SK-SMB

Small micro boring bar



Fig.1



Head

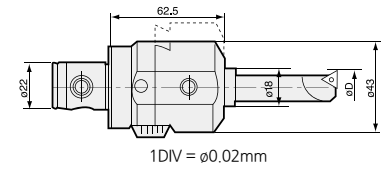


Fig.2

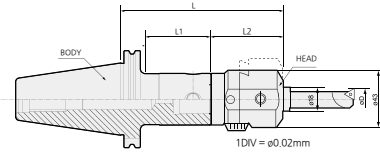
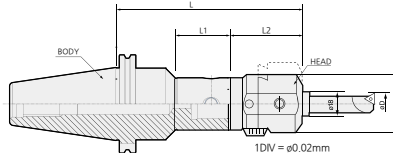


Fig.3



- Adjustment length : 17mm
- This product does not support the internal coolant system.
- ※ Red : Main component Blue : For separate purchase

- For more information on MD arbor, see [126p](#)
- For more information on BB bite, see [184p](#)
- For more information on the related parts, see [183p](#)

	Model No.			Boring range (ØD)	L	L1	L2	Fig.	Head weight
	Head model no.	Arbor Model No.	BB bite						
HSK63	SMB4022	HSK63A-MD40F-70	BB18-□(S)	ø6.0-ø34.0	132.5	41	62.5	1	0.6
SK40	SMB4022	SK40-MD40F-60	BB18-□(S)	ø6.0-ø34.0	122.5	40	62.5	2	0.6
	SMB4022	SK40-MD40F-100	BB18-□(S)	ø6.0-ø34.0	162.5	80	62.5	2	0.6
SK50	SMB4022	SK50-MD40F-145	BB18-□(S)	ø6.0-ø34.0	207.5	120	62.5	2	0.6
	SMB4022	SK50-MD40F-220R	BB18-□(S)	ø6.0-ø34.0	282.5	83	62.5	3	0.6

BB Bite(For SMB)

Model No.	Boring range(ØD)		Insert	Screw	Kg
	Min	Max			
BB18-7(S)	8	28	TBGT0601□□L	BFTX0204A	0.1
BB18-9(S)	10	30	TBGT0802□□L	BFTX0204A	0.1
BB18-11(S)	12	32	TBGT1103□□L	BFTX0307A	0.1
BB18-13(S)	14	34	TBGT1103□□L	BFTX0307A	0.1
BB18-15(S)	16	36	TBGT1103□□L	BFTX0307A	0.2
BB18-17(S)	18	38	TBGT1103□□L	BFTX0307A	0.2



BT-KMB

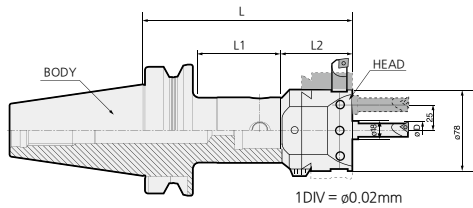
Micro boring



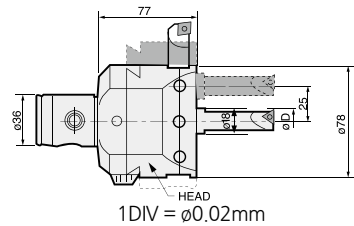
MAS 403-BT
C
Ø8
Ø165

Shank Coolant System MIN Range MAX Range Boring

Fig.1



Head



• Adjustment length: 7mm

C This product does not support the internal coolant system.

※ Red : Main component Blue : For separate purchase

• For more information on MD arbor, see **126p**

• For more information on BB bite, see **184p**

• For more information on the related parts, see **183p**

Model No.			Boring range(ØD)		L	L1	L2	Fig.	Head weight	
Head model no.	Arbor Model No.	BB Bite	Bite position	Ø D						
BT40	KMB6336	BT40-MD63F-64	Center Hole	Ø8.0~Ø38.0	141	37	77	1	2.2	
	KMB6336	BT40-MD63F-110			187	83	77	1	2.2	
	KMB6336	BT40-MD63F-135	Eccentric Hole		Ø41.0~101.0	212	108	77	1	2.2
	KMB6336	BT50-MD63F-75				152	35	77	1	2.2
BT50	KMB6336	BT50-MD63F-130	Side Hole	Max.Ø165.0	207	87	77	1	2.2	
	KMB6336	BT50-MD63F-195			272	152	77	1	2.2	

※ The bite position has no bearing on the body model no.

BB Bite(For KMB)

Model No.	Boring range(ØD)		Insert(ISO)	Screw	Kg
	Min	Max			
BB18-7(S)	8	28	TBGT0601□□L	BFTX0204A	0.1
BB18-9(S)	10	30	TBGT0802□□L	BFTX0204A	0.1
BB18-11(S)	12	32	TBGT1103□□L	BFTX0307A	0.1
BB18-13(S)	14	34	TBGT1103□□L	BFTX0307A	0.1
BB18-15(S)	16	36	TBGT1103□□L	BFTX0307A	0.2
BB18-17(S)	18	38	TBGT1103□□L	BFTX0307A	0.2



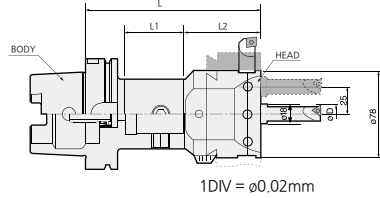
HSK/SK-KMB

Micro boring



DIN 69893-1	DIN69871 -1A/B	C	Ø8	Ø165	
Shank	Shank	Coolant System	MIN Range	MAX Range	Boring

Fig.1



Head

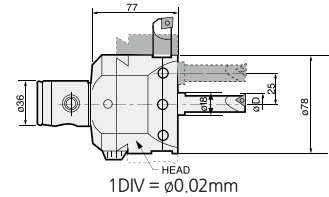


Fig.2

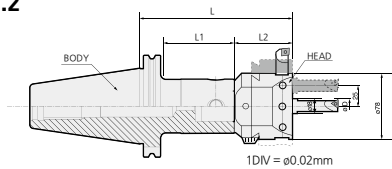
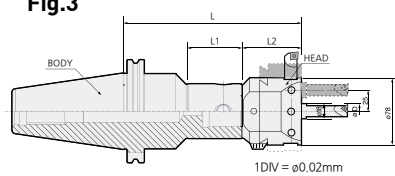


Fig.3



- Adjustment length: 7mm
- Ⓢ This product does not support the internal coolant system.
- ⊗ Red : Main component Blue : For separate purchase

- For more information on MD arbor, see **126p**
- For more information on BB bite, see **184p**
- For more information on the related parts, see **183p**

Model No.			Boring range(ØD)		L	L1	L2	Fig.	Head weight	
Head model no.	Arbor Model No.	BB Bite	Bite position	Ø D						
HSK63	KMB6336	HSK63A-MD63F-95	BB18-□(S)	Center Hole	Ø8.0~Ø38.0	172	69	77	1	2.2
SK40	KMB6336	SK40-MD63F-70	BB18-□(S)	Eccentric Hole	Ø41.0~101.0	147	50	77	2	2.2
SK50	KMB6336	SK50-MD63F-130	BB18-□(S)	Side Hole	Max.165.0	207	107	77	2	2.2
	KMB6336	SK50-MD63F-230R	BB18-□(S)			307	149	77	3	2.2

⊗ The bite position has no bearing on the body model no.

BB Bite(For KMB)

Model No.	Boring range(ØD)		Insert(ISO)	Screw	Kg
	Min	Max			
BB18-7(S)	8	28	TBGT0601□□L	BFTX0204A	0.1
BB18-9(S)	10	30	TBGT0802□□L	BFTX0204A	0.1
BB18-11(S)	12	32	TBGT1103□□L	BFTX0307A	0.1
BB18-13(S)	14	34	TBGT1103□□L	BFTX0307A	0.1
BB18-15(S)	16	36	TBGT1103□□L	BFTX0307A	0.2
BB18-17(S)	18	38	TBGT1103□□L	BFTX0307A	0.2



BT-SMH

Small micro boring bar



MAS 403-BT
C
Ø8
Ø38
Boring

Shank Coolant System MIN Range MAX Range Boring

Fig.1

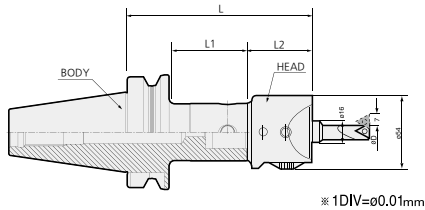
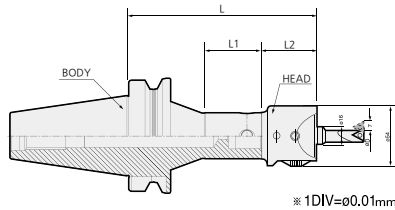
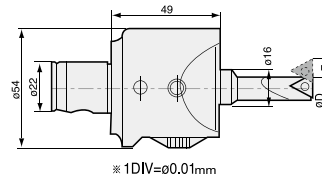


Fig.2



Head



• Adjustment length: 7mm

C This product does not support the internal coolant system.

※ Red : Main component Blue : For separate purchase

• For more information on MD arbor, see **126p**

• For more information on BB bite, see **184p**

• For more information on the related parts, see **183p**

	Model No.			Boring range (ØD)	L	L1	L2	Fig.	Head weight
	Head model no.	Arbor Model No.	BB Bite						
BT30	SMH4022	BT30-MD40F-45	BB16-□(S)	Ø6.0~Ø34.0	94	22	49	1	0.6
	SMH4022	BT30-MD40F-60	BB16-□(S)	Ø6.0~Ø34.0	109	36	49	1	0.6
	SMH4022	BT30-MD40F-80	BB16-□(S)	Ø6.0~Ø34.0	129	56	49	1	0.6
BT40	SMH4022	BT40-MD40F-60	BB16-□(S)	Ø6.0~Ø34.0	109	31	49	1	0.6
	SMH4022	BT40-MD40F-110R	BB16-□(S)	Ø6.0~Ø34.0	159	60	49	2	0.6
	SMH4022	BT40-MD40F-115	BB16-□(S)	Ø6.0~Ø34.0	164	83	49	1	0.6
BT50	SMH4022	BT50-MD40F-60	BB16-□(S)	Ø6.0~Ø34.0	109	22	49	1	0.6
	SMH4022	BT50-MD40F-195	BB16-□(S)	Ø6.0~Ø34.0	244	152	49	1	0.6
	SMH4022	BT50-MD40F-230R	BB16-□(S)	Ø6.0~Ø34.0	279	180	49	2	0.6

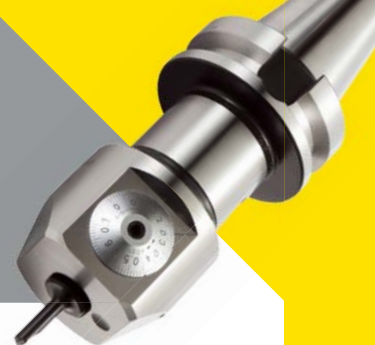
BB Bite(For SMH) For separate purchase

Model No.	Boring range(center)		S	ød	L1	L2	Insert(ISO)	Insert Screw	Wrench
	Min.	Max.							
BB16 - 5(S)	5	19	2.75	16	34	20	WBG0601□□L	BFTX0203A	TRX06
BB16 - 7(S)	7	21	3.5			30	TBGT0601□□L	BFTX0204A	
BB16 - 9(S)	9	23	4.5			40	TPGT0802□□L	BFTX0307A	
BB16 - 11(S)	11	25	5.5			45	TPGT1103□□L		
BB16 - 15(S)	15	29	7.5			50	TPGT1604□□L	BFTX0410A	TRX10
BB16 - 19(S)	19	33	9.5			60	TPGT1604□□L		TRX15



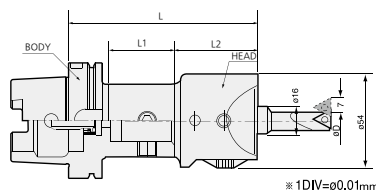
HSK/SK-SMH

Small micro boring bar



DIN 69893-1	DIN69871 -1A/B	C	Ø8	Ø38	
Shank	Shank	Coolant System	MIN Range	MAX Range	Boring

Fig.1



Head

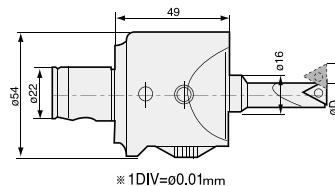


Fig.2

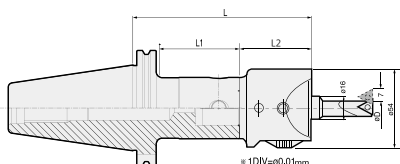
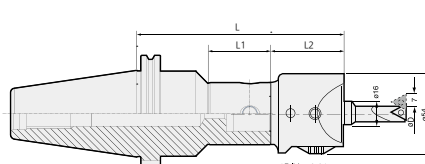


Fig.3



• Adjustment length : 17mm

C This product does not support the internal coolant system.

※ Red : Main component Blue : For separate purchase

• For more information on MD arbor, see **126p**

• For more information on BB bite, see **184p**

• For more information on the related parts, see **183p**

	Model No.			Boring range (ØD)	L	L1	L2	Fig.	Head weight
	Head model no.	Arbor Model No.	BB Bite						
HSK63	SMH4022	HSK63A-MD40F-70	BB16-□(S)	Ø6.0~Ø34.0	132.5	41	49	1	0.6
SK40	SMH4022	SK40-MD40F-60	BB16-□(S)	Ø6.0~Ø34.0	122.5	40	49	2	0.6
	SMH4022	SK40-MD40F-100	BB16-□(S)	Ø6.0~Ø34.0	162.5	80	49	2	0.6
SK50	SMH4022	SK50-MD40F-145	BB16-□(S)	Ø6.0~Ø34.0	207.5	120	49	2	0.6
	SMH4022	SK50-MD40F-220R	BB16-□(S)	Ø6.0~Ø34.0	282.5	83	49	3	0.6

BB Bite(For SMH) For separate purchase

Model No.	Boring range(ØD)		Insert(ISO)	Screw	Kg
	Min	Max			
BB16-7(S)	8	28	TBGT0601□□L	BFTX0204A	0.1
BB16-9(S)	10	30	TBGT0802□□L	BFTX0204A	0.1
BB16-11(S)	12	32	TBGT1103□□L	BFTX0307A	0.1
BB16-13(S)	14	34	TBGT1103□□L	BFTX0307A	0.1
BB16-15(S)	16	36	TPGT1604□□L	BFTX0307A	0.2
BB16-17(S)	18	38	TBGT1604□□L	BFTX0307A	0.2



SMH SET

Small micro boring Set



SMH(SET1)



SMH(SET2)



SMH(SET4)



SET NUMBER






TYPE	Model No.	SMH (SET1)	SMH (SET2)	SMH (SET4)	Applicable insert
Boring head	SMH4022	1	1	1	
Arbor	BT40-MD40F-60	1			
Arbor	BT50-MD40F-60		1		
BB Bite (STEEL)	BB16-0624(S)	1	1	1	WBG060102L
BB Bite (STEEL)	BB16-0832(S)	1	1	1	WBG060102L
BB Bite (STEEL)	BB16-1040(S)	1	1	1	TPG080202L
BB Bite (STEEL)	BB16-1253(S)	1	1	1	TPG080202L
BB Bite (STEEL)	BB16-1668(S)	1	1	1	TPG110304L
BB Bite (STEEL)	BB16-2083(S)	1	1	1	TPG110304L
BB Bite (STEEL)	BB16-2590(S)	1	1	1	TPG110304L
BB Bite (STEEL)	BB16-3090(S)	1	1	1	TPG110304L
Screw	BFTX0203A	2	2	2	
Screw	BFTX0204A	2	2	2	
Screw	BFTX0307A	2	2	2	
Wrench	LW-3	1	1	1	
Wrench	LW-5	1	1	1	
Wrench	TRX06	1	1	1	
Wrench	TRX10	1	1	1	



SMB SPARE PART

Small micro boring bar related parts

Spare Part

Type	Main purchased item			Item for separate purchase	
	Boring head	Taper screw	Wrench	Boring bite	MD arbor
Images					
Model No.					
SMB	SMB4022	BTT1013F	LW-2.5	BB18	MD40F






- The taper screw is built in the arbor by default.
- For more information on MD arbor, see **126p**.



KMB SPARE PART

Micro boring related parts

Spare Part

Type	Main purchased item			Item for separate purchase	
	Boring head	Taper screw	Wrench	Boring bite	MD arbor
Images					
Model No.					
KMB	KMB6336	BTT1620F	LW-4.0	BB18	MD63F






- The taper screw is built in the arbor by default.
- For more information on MD arbor, see **126p**.



SMH SPARE PART

Small micro boring bar (precision type) related parts

Spare Part

Type	Main purchased item			Item for separate purchase	
	Boring head	Taper screw	Wrench	Boring bite	MD arbor
Images					
Model No.					
SMH	SMH4022	BTT1013F	LW-3.0	BB16	MD40F

- The taper screw is built in the arbor by default.
- For more information on MD arbor, see **126p**.

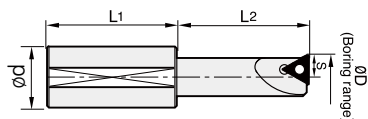


BB BITE

BB Bite(for SMB, SMH, KMB)

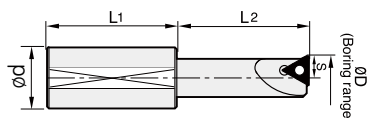


Boring bite : BB type(for SMB)



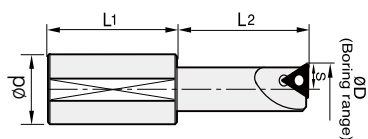
Designation	Boring range (center)		S	ød	L1	L2	Insert	Insert screw
	Min.	Max.						
BB18 - 7(S)	7	27	3.5	18	30	30	TBGT0601□□L	BFTX0204A
BB18 - 9(S)	9	29	4.5	18	30	40	TPGT0802□□L	
BB18 - 11(S)	11	31	5.5	18	30	45	TPGT1103□□L	BFTX0307A
BB18 - 13(S)	13	33	6.5	18	40	45		
BB18 - 15(S)	15	35	7.5	18	40	50		
BB18 - 17(S)	17	37	8.5	18	40	50		

Boring bite : BB type(for SMH)



Designation	Boring range (center)		S	ød	L1	L2	Insert	Insert screw	Wrench
	Min.	Max.							
BB16 - 5(S)	5	19	2.75	16	34	20	WBG0601□□L	BFTX0203A	TRX06
BB16 - 7(S)	7	21	3.5	16	34	30	TBGT0601□□L	BFTX0204A	
BB16 - 9(S)	9	23	4.5	16	34	40	TPGT0802□□L	BFTX0307A	TRX10
BB16 - 11(S)	11	25	5.5	16	34	45	TPGT1103□□L		
BB16 - 15(S)	15	29	7.5	16	34	50	TPGT1604□□L	BFTX0410A	TRX15
BB16 - 19(S)	19	33	9.5	16	34	60	TPGT1604□□L		

Boring bite : BB type(for KMB)



Designation	Boring range(center)		S	ød	L1	L2	Insert	Insert screw		
	Center	Eccentric								
BB18 - 7(S)	7	40	27	91	3.5	18	30	30	TBGT0601□□L	BFTX0204A
BB18 - 9(S)	9	42	29	93	4.5	18	30	40	TPGT0802□□L	
BB18 - 11(S)	11	44	31	95	5.5	18	30	45	TPGT1103□□L	BFTX0307A
BB18 - 13(S)	13	46	33	97	6.5	18	40	45		
BB18 - 15(S)	15	48	35	99	7.5	18	40	50		
BB18 - 17(S)	17	50	37	101	8.5	18	40	50		

Standard Boring Bite(Insert type)

Maker	Designation	Purpose of use	Boring Ø	Insert
Sumitomo SEI	BBPT (WBPT: Carbide Shank)	For through hole boring (for Through hole boring) for blind hole and through hole	Ø8,10,12,16	TBGT0601□□L, TPGT0802□□L, TPGT1103□□L
	BBPW (WBPW: Carbide Shank)		Ø5.5,8,10	WBG0601□□L, WBMT0601□□L, WBG0802□□L
	S-SCLCR [C-SCLCR: Carbide Shank]		Ø8,10,12,16	CCGT0602□□, CCMT0602□□, CCGT09T3□□, CCMT09T3□□
	S-STFPR [C-STFPR: Carbide Shank]	For through hole boring (for Through hole boring)	Ø12,16	TPGT1103□□L
S-STUPR	Ø8		TBGT0601□□L, TPGT0802□□L	
S-SWUBR (E-SWUBR: Carbide Shank)	Ø5.5,8,10		WBG0601□□L, WBG0802□□L, CCMT0602□□, CCGT0602□□	
S-SCLCR [C-SCLCR: Carbide Shank]	For blind hole and through hole		Ø10,12,16	CCMT09T3□□, CCGT09T3□□
S-SCLPR [C-SCLPR: Carbide Shank]	(for Stop and through hole boring)		Ø8,10,12,16	CPGT0802□□, CPGT0903□□



BH

Square boring bite for BSA



Boring

Fig.1

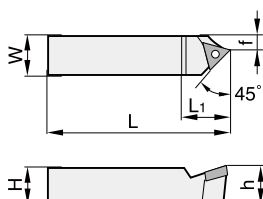
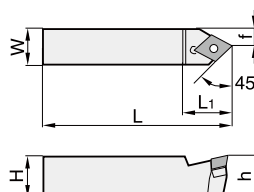


Fig.2



Model No.	Fig.	W=H	h	L	L1	f	Usable insert	Insert screw	Insert wrench
BH408	1	8	7.8	40	9	3.2	TPGT0802□□L	BFTX0204A	TRX06
BH410	2	10	9.8	50	10	4.2	CPMT0602□□	BFTX02056N	TRX08
BH413	2	13	12.8	60	14	6.2	CPMT0803□□	BFTX0307N	TRX10
BH416	2	16	15.8	80	18	7.3	CPMT0903□□	BFTX0407A	TRX15
BH419	2	19	18.8	95	22	10.3	CPMH1204□□	BFN0511T	TRX20
BH425	2	25	24.8	125	26	14.2	CPMH1604□□	BFX0611R	LW-3.0

Insert for Square Boring Bite

Maker	Insert	Grade	Workpiece	Cutting
KORLOY	CCGT0602□□-AK	H01	Aluminium	General
	CCGT09T3□□-AK			
	CCGT1204□□-AK			

Maker	Insert	Grade	Workpiece	Cutting
SUMITOMO	TPGT0802□□	Cermet : T1500A	Steel, Cast iron, Stainless Steel	finishing
	CPMT0602□□	Coated : AC6030M	Steel	general
	CPMT0803□□	Coated : AC6030M	Steel	general
	CPMT0903□□	Coated: AC8015P	Steel, Alloy Steel, Cast iron	general
		Coated: AC6030M	Stainless Steel	general
		Cermet : T3000Z	Steel, Cast iron, Stainless Steel	finishing-general
	CPMH1204□□	Coated: AC6030M	Steel, Stainless Steel	general
CPMH1604□□	Coated: AC6030M	Steel, Stainless Steel	general	

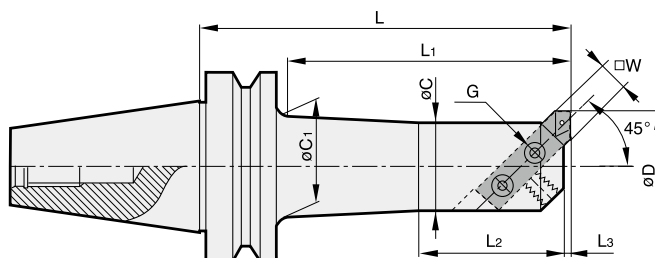


BSA

Square boring bar



MAS 403-BT	C	25	125	
Shank	Coolant System	MIN Range	MAX Range	Boring



• For more information on BB bite, see **185p**.


C This product does not support the internal coolant system.

• For more information on the related parts, see **187p**.

Model No.	ØD		L	ØC	L1	L2	L3	ØC1	W	G	Kg	Package weight (Kg)
	MIN	MAX										
BT50-BSA25-135	25	38	135	20	92	35	1.0	22	8	M6	3.8	4.2
BT50-BSA30-165	30	42	165	24	122	40	1.6	26	8	M6	4.1	4.5
BT50-BSA38-180	38	52	180	30	137	50	2.6	33	10	M8	4.5	4.9
BT50-BSA42-210	42	56	210	34	167	60	2.0	37	10	M8	4.9	5.3
BT50-BSA50-180	50	65	180	40	137	65	3.0	46	13	M10	5.1	5.5
BT50-BSA50-240	50	65	240	40	197	65	3.0	44	13	M10	5.8	6.2
BT50-BSA62-195	62	90	195	50	152	80	2.0	56	16	M10	5.9	6.3
BT50-BSA62-270	62	90	270	50	227	80	2.0	56	16.0	M10	7.4	7.8
BT50-BSA72-195	72	110	195	60	152	95	2.4	66	19.0	M12	6.8	7.2
BT50-BSA72-285	72	110	285	60	242	95	2.4	66	19.0	M12	9.1	9.5
BT50-BSA90-210	90	125	210	75	167	110	4.0	80	19.0	M12	9.1	9.5



Main components

Spare Part		Main components	
Type		Set screw	
Model No.	Images		
	BSA25		BTF0606
BSA30		BTF0606	
BSA38		BTF0808	
BSA42		BTF0810	
BSA50		BTF1012	
BSA62		BTF1016	
BSA72		BTF1216	
BSA90		BTF1220	
BSA105		BTF1225	

For separate purchase

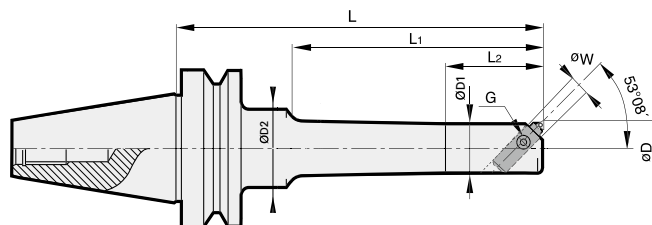
Spare Part		For separate purchase	
Type		Bite	Wrench
Model No.	Images		
	BSA25		BH408
BSA30		BH408	LW-4
BSA38		BH410	LW-4
BSA42		BH410	LW-5
BSA50		BH413	LW-5
BSA62		BH416	LW-5
BSA72		BH419	LW-5
BSA90		BH419	LW-6
BSA105		BH425	LW-6

- For more information on BH boring bite, see [185p](#)



BT-BKA

FZ Micro boring bar



C This product does not support the internal coolant system.

※ Red : Main component Blue : For separate purchase

※ For more information on the boring range and insert used, see the FZ unit table.

• The boring unit is an item for separate purchase.

• For more information on the FZ unit, see **190p**

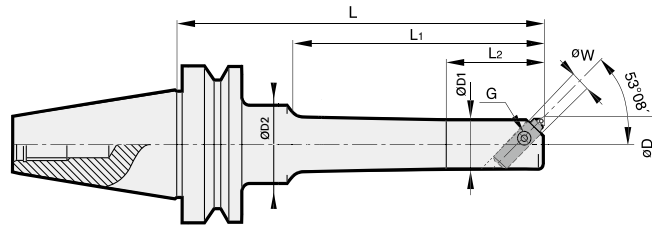
• For more information on the related parts, see **191p**

	Model No.	FZ unit	L	L1	L2	ØD1	ØD2	W	G	Kg	Package weight (Kg)
BT30	BT30-BKA28-150	FZ10-□□-3(S)	150	123	-	25	-	10	M6	0.9	1.0
	BT30-BKA36-150	FZ12-□□-3(S)	150	125	-	32	-	12	M8	1.2	1.3
	BT30-BKA45-150	FZ16-□□-3(S)	150	128	-	40	-	16	M10	1.6	1.7
BT40	BT40-BKA23-150	FZ8-□□-3	150	95	40	20	22	8	M6	1.6	1.9
	BT40-BKA23-225	FZ8-□□-3	225	95	40	20	22	8	M6	2.8	3.1
	BT40-BKA28-165	FZ10-□□-3(S)	165	122	50	25	26	10	M6	1.5	1.7
	BT40-BKA28-225	FZ10-□□-3(S)	225	125	50	25	26	10	M6	2.6	2.9
	BT40-BKA36-165	FZ12-□□-3(S)	165	133	60	32	35	12	M8	1.9	2.1
	BT40-BKA36-225	FZ12-□□-3(S)	225	193	60	32	35	12	M8	2.8	3.1
	BT40-BKA45-165	FZ16-□□-3(S)	165	133	70	40	44	16	M10	2.3	2.6
	BT40-BKA45-225	FZ16-□□-3(S)	225	208	70	40	44	16	M10	3.0	3.2
	BT40-BKA56-165	FZ20-□□-3(S)	165	-	70	50	54	20	M12	3.0	3.2
	BT40-BKA56-240	FZ20-□□-3(S)	240	-	70	50	54	20	M12	4.2	4.5
	BT40-BKA72-165	FZ25-□□-3(S)	165	-	-	63	-	25	M16	4.0	4.2
	BT40-BKA72-240	FZ25-□□-3(S)	240	-	-	63	-	25	M16	5.7	5.9
	BT40-BKA90-165	FZ32-□□-3(S)	165	-	100	80	-	32	M20	4.9	5.2
	BT40-BKA90-240	FZ32-□□-3(S)	240	-	100	80	-	32	M20	6.8	7.0



BT-BKA

FZ Micro boring bar



C This product does not support the internal coolant system.

※ Red : Main component Blue : For separate purchase

※ For more information on the boring range and insert used, see the FZ unit table.

• The boring unit is an item for separate purchase.

• For more information on the FZ unit, see **190p**.

• For more information on the related parts, see **191p**.

Model No.	FZ unit	L	L1	L2	ØD1	ØD2	W	G	Kg	Package weight (Kg)
BT50-BKA23-150	FZ8-□□-3	150	95	40	20	22	8	M6	4.2	4.6
BT50-BKA23-225	FZ8-□□-3	225	95	40	20	22	8	M6	5.3	5.7
BT50-BKA28-165	FZ10-□□-3(S)	165	122	50	25	26	10	M6	4.1	4.5
BT50-BKA28-225	FZ10-□□-3(S)	225	122	50	25	26	10	M6	5.1	5.5
BT50-BKA36-165	FZ12-□□-3(S)	165	122	60	32	35	12	M8	4.4	4.8
BT50-BKA36-225	FZ12-□□-3(S)	225	182	60	32	35	12	M8	4.9	5.3
BT50-BKA45-165	FZ16-□□-3(S)	165	122	70	40	44	16	M10	4.8	5.2
BT50-BKA45-225	FZ16-□□-3(S)	225	182	70	40	44	16	M10	5.5	5.9
BT50-BKA56-165	FZ20-□□-3(S)	165	122	70	50	54	20	M12	5.5	5.9
BT50-BKA56-240	FZ20-□□-3(S)	240	197	70	50	54	20	M12	6.7	7.1
BT50-BKA72-165	FZ25-□□-3(S)	165	122	80	63	68	25	M16	6.5	6.9
BT50-BKA72-240	FZ25-□□-3(S)	240	197	80	63	68	25	M16	8.5	8.9
BT50-BKA90-165	FZ32-□□-3(S)	165	122	197	80	-	32	M20	7.9	8.3
BT50-BKA90-240	FZ32-□□-3(S)	240	197	-	80	-	32	M20	10.9	11.3
BT50-BKA110-270	FZ32-□□-3(S)	270	-	-	100	-	32	M20	14.8	15.2

BT50

Chuck

Arbor / Modular

Boring tool

Angular head

cBN/PCD

Smart factory

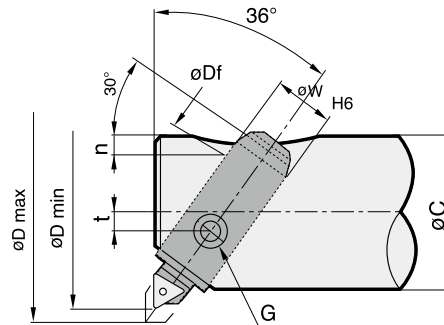
TAUMAX

OTHER



Coolant System

Boring



C This product does not support the internal coolant system.

• For more information on the insert, see **191p**.

※ In case of one gradation adjustment, $\phi 0.02\text{mm}$

• For more information on the related parts, see **191p**.

Model No.	ϕD		Insert holder (ISO)	Insert (ISO)	ϕC	n	ϕD_f	t	G	W	Kg	Package weight (Kg)
	MIN	MAX										
FZ8-23-3(P10,K10)	23	29(32)	8Z3 (Brazed tip)	-	20	3	8	1.5	M6	8	0.04	0.04
FZ8-26-3(P10,K10)	26	32(34)	8Z3 (Brazed tip)	-	20	3	8	1.5	M6	8	0.04	0.04
FZ10-28-3(S)	28	34(38)	U10Z3S	TBGT0601□□L	25	3.5	8	2	M6	10	0.1	0.1
FZ10-32-3(S)	32	38(44)	U10Z3S	TBGT0601□□L	25	3.5	8	2	M6	10	0.1	0.1
FZ12-36-3(S)	36	44(48)	U12Z3S	TBGT0601□□L	32	4	10	2.5	M8	12	0.1	0.1
FZ12-40-3(S)	40	48(55)	U12Z3S	TBGT0601□□L	32	4	10	2.5	M8	12	0.1	0.1
FZ16-45-3(S)	45	54(60)	U16Z3S	TBGT0802□□L	40	6.5	12	3	M10	16	0.1	0.0
FZ16-50-3(S)	50	59(68)	U16Z3S	TBGT0802□□L	40	6.5	12	3	M10	16	0.1	0.1
FZ20-56-3(S)	56	68(78)	U20Z3S	TBGT0802□□L	50	7	16	5	M12	20	0.2	0.2
FZ20-64-3(S)	64	76(90)	U20Z3S	TBGT0802□□L	50	7	16	5	M12	20	0.2	0.2
FZ25-72-3(S)	72	88(100)	U25Z3S	TPGT1103□□L	63	8	20	4	M16	25	0.3	0.3
FZ25-80-3(S)	80	96(114)	U25Z3S	TPGT1103□□L	63	8	20	4	M16	25	0.3	0.3
FZ32-90-3(S)	90	114(126)	U32Z3S	TPGT1103□□L	80	10	25	6	M20	32	0.6	0.6
FZ32-100-3(S)	100	124(140)	U32Z3S	TPGT1103□□L	80	10	25	6	M20	32	0.6	0.6
FZ32-110-3(S)	110	134(150)	U32Z3S	TPGT1103□□L	100	10	25	12	M20	32	0.7	0.7
FZ32-125-3(S)	125	149(175)	U32Z3S	TPGT1103□□L	100	10	25	12	M20	32	0.8	0.8

1:1 Chat



FZ UNIT SPARE PART

FZ unit related parts



Spare Part

TYPE	Main components					For separate purchase
	Housing	Spindle	Insert screw	Torx Wrench	L-Wrench	Torx Wrench
Images						
Model No.						
FZ8-23, 26-3, P10	8-23, 26-3	8Z3(P10)	-	-	LW-1.5	R0/N0
FZ8-23, 26-3, K10	8-23, 26-3	8Z3(P10)	-	-	LW-1.5	R0/N0
FZ10-28, 32-3(S)	10-28, 32-3	U10Z3-TB06	BFTX0204A	TRX6	LW-2.0	R2/N1
FZ12-36, 40-3(S)	12-36, 40-3	U12Z3-TB06	BFTX0204A	TRX6	LW-2.5	R2A/N2
FZ16-45, 50-3(S)	16-45, 50-3	U16Z3-TP08	BFTX0204A	TRX6	LW-3.0	N3
FZ20-56, 64-3(S)	20-56, 64-3	U20Z3-TP08	BFTX0204A	TRX6	LW-4.0	R4/N4
FZ25-72, 80-3(S)	25-72, 80-3	U25Z3-TP11	BFTX0307A	TRX10	LW-4.0	ZV25
FZ32-90, 100, 110, 125-3(S)	32-90, 100-3	UZ32Z3-TP11	BFTX0307A	TRX10	LW-5.0	R5/N5

1:1 Chat



INSERT

FZ Unit, FF Unit

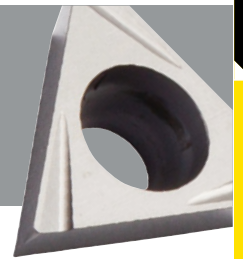


Fig. 1
(With Chip Breaker)

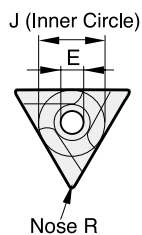


Fig. 2
(Without Chip Breaker)

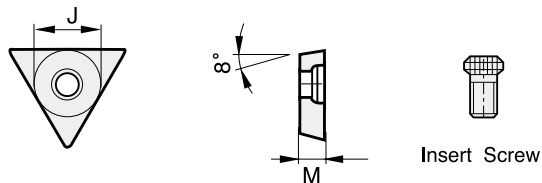


Fig.	Grade of Insert	Workpiece
1	K10(W.C)	Cast Iron, Aluminium
1	P10(W.C)	Steel, Stainless Steel
1	CN1000 or CN2000(Cermet)	Steel
2	K10(W.C)	Exclusive for Cast Iron

INSERT	Fig.	J	R	M	E	Insert screw	Wrench
TBGT0601□□L	1	3.97	0.2	1.59	2.2	BFTX0204A	TRX6
TPGT0802□□L	1	4.76	0.2	2.38	2.4	BFTX0204A	TRX6
TPGT1103□□L	1	6.35	0.4	3.18	2.8	BFTX0307A	TRX10

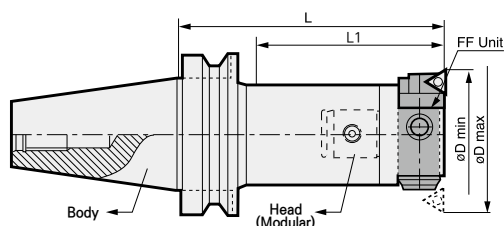


BT-BCF

Micro boring bar



MAS 403-BT	C	29.5	141	
Shank	Coolant System	MIN Range	MAX Range	Boring



C This product does not support the internal coolant system.

※ Red : Main component Blue : For separate purchase

※ The bodies, boring units, and head sets are sold individually.

• For more information on FF boring unit, see **194p**

• For more information on the applicable insert, see **195p**

• For more information on the related parts, see **194p**

	Model No.			ØD		L	L1	Kg	Kg (Package weight)
	Arbor Model No.	Head	Boring unit	MIN	MAX				
BT30	BT30-MD25F-90	BCF2530	FF10-30(S)	29.5	42	140	93	0.3	0.6
	BT30-MD32F-80	BCF3239	FF12-39(S)	39	50	140	99	0.4	0.7
	BT30-MD40F-80	BCF4047	FF16-47(S)	47	66	170	109	0.6	0.9
	BT30-MD50F-70	BCF5058	FF20-58(S)	58	83	125	98	1	0.9
BT40	BT40-MD25F-95	BCF2530	FF10-30(S)	29.5	42	145	72	0.3	1.1
	BT40-MD32F-100	BCF3239	FF12-39(S)	39	50	160	96	0.4	1.1
	BT40-MD40F-115	BCF4047	FF16-47(S)	47	66	175	120	0.6	1.6
	BT40-MD50F-105	BCF5058	FF20-58(S)	58	83	175	143	1	1.8
	BT40-MD63F-110	BCF6379	FF25-79(S)	79	108	180	148	1.7	2.4
	BT40-MD80F-100	BCF100	FF32-100(S)	100	141	200	168	3.8	2.9
BT50	BT50-MD25F-105	BCF2530	FF10-30(S)	29.5	42	155	72	0.3	3.8
	BT50-MD32F-110	BCF3239	FF12-39(S)	39	50	170	96	0.4	4
	BT50-MD40F-195	BCF4047	FF16-47(S)	47	66	255	143	0.6	4.8
	BT50-MD50F-225	BCF5058	FF20-58(S)	58	83	295	195	1	6
	BT50-MD63F-195	BCF6379	FF25-79(S)	79	108	265	222	1.6	6.8
	BT50-MD80F-175	BCF100	FF32-100(S)	100	141	275	232	3.8	8

※ Right-angled type micro boring bar

※ Boring unit (Insert)

- FF10-30(S) / FF12-39(S) (TBGT0601□□L)
- FF16-47(S) / FF20-58(S) (TBGT0802□□L)
- FF25-79(S) / FF32-100(S) (TBGT1103□□L)



BT-BCF

Micro boring bar



Fig.1

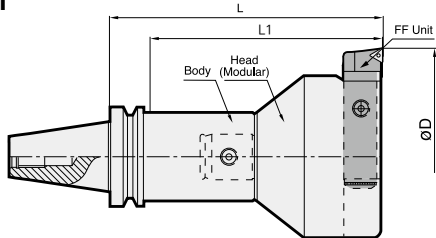
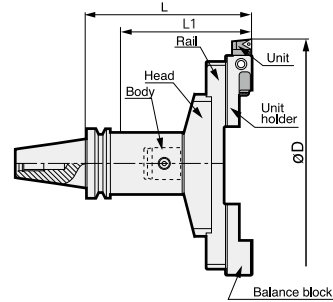


Fig.2



1DIV. = $\varnothing 0.02\text{mm}$

C This product does not support the internal coolant system.

※ Red : Main component Blue : For separate purchase

※ The bodies, boring units, and head sets are sold individually.

- For more information on MD arbor, see **126p**
- For more information on FF boring unit, see **194p**
- For more information on the applicable insert, see **195p**
- For more information on the related parts, see **194p**

	Model No.			ØD		L	L1	Fig	Kg (Package weight)
	Arbor Model No.	Head set	FF Unit	MIN	MAX				
BT50	BT50-MD90F-75	BCF138	FF32-138(S)	138	159	175	120	1	8
	BT50-MD90F-145	BCF138	FF32-138(S)	150	159	245	190	1	9
	BT50-MD90F-75	BCF150	FF32-138(S)	170	171	175	120	1	9.6
	BT50-MD90F-145	BCF150	FF32-138(S)	190	171	245	190	1	12.4
	BT50-MD90F-195	BCF150	FF32-138(S)	210	171	295	240	1	15.4
	BT50-MD90F-75	BCF170	FF32-138(S)	230	191	175	120	1	9.8
	BT50-MD90F-145	BCF170	FF32-138(S)	250	191	245	190	1	12.6
	BT50-MD90F-195	BCF170	FF32-138(S)	355	191	295	240	1	15.8
	BT50-MD90F-75	BCF190	FF32-138(S)	138	211	175	120	1	10.2
	BT50-MD90F-145	BCF190	FF32-138(S)	150	211	245	190	1	13
	BT50-MD90F-195	BCF190	FF32-138(S)	170	211	295	240	1	16.1
	BT50-MD90F-75	BCF210	FF32-138(S)	190	231	175	120	1	10.5
	BT50-MD90F-145	BCF210	FF32-138(S)	210	231	245	190	1	13.4
	BT50-MD90F-195	BCF210	FF32-138(S)	230	231	295	240	1	16.5
	BT50-MD90F-75	BCF230	FF32-138(S)	250	251	175	120	1	13.1
	BT50-MD90F-145	BCF230	FF32-138(S)	355	251	245	190	1	15.6
	BT50-MD90F-195	BCF230	FF32-138(S)	170	251	295	240	1	18.2
	BT50-MD90F-75	BCF250FS	FF25-79(S)	190	355	182	182	2	14.3
	BT50-MD90F-145	BCF250FS	FF25-80(S)	210	355	252	252	2	17.2
	BT50-MD90F-195	BCF250FS	FF25-81(S)	230	355	302	302	2	21.2
BT50-MD90F-75	BCF350FS	FF25-82(S)	250	450	182	182	2	16.4	
BT50-MD90F-145	BCF350FS	FF25-83(S)	355	450	252	252	2	19	
BT50-MD90F-195	BCF350FS	FF25-84(S)	250	450	302	302	2	20.8	

※ Modular type micro boring bar

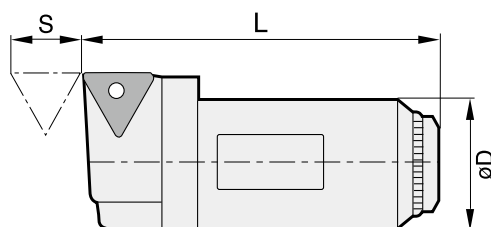
※ Boring unit (Insert)

- FF10-30(S) / FF12-39(S) (TBGT0601□□L)
- FF16-47(S) / FF20-58(S) (TBGT0802□□L)
- FF25-79(S) / FF32-100(S) (TBGT1103□□L)



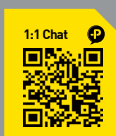
FF

FF Unit_micro boring unit



	Model No.	ØD	L	S	Usable insert
FF Unit	FF10-30(S)	10	28.5	3.5	TBGT0601□□L
	FF12-39(S)	12	37.5	3.5	TBGT0601□□L
	FF16-47(S)	16	45	5	TPGT0802□□L
	FF20-58(S)	20	56	7	TPGT0802□□L
	FF25-79(S)	25	77.5	8	TPGT1103□□L
	FF32-100(S)	32	97	11	TPGT1103□□L
	FF32-138(S)	32	131	11	TPGT1103□□L

C This product does not support the internal coolant system.



FF UNIT SPARE PART

FF Unit related parts

Spare Part

Type	Main components		
	Clamp screw	Torx Wrench	Wrench
Images			
Model No.			
FF10-30(S)	BFTX0204A	TRX06	LW-2
FF12-39(S)	BFTX0204A	TRX06	LW-2.5
FF16-47(S)	BFTX0204A	TRX06	LW-3
FF20-58(S)	BFTX0204A	TRX06	LW-4
FF25-79(S)	BFTX0307A	TRX10	LW-4
FF32-100(S)	BFTX0307A	TRX10	LW-5



INSERT

Boring Insert

INSERT	Applicable item (boring head)
CCET0301□□L	FBB15C(FBH15,FBH18)
CCET0401□□L	FBB20N-C, FBB20N-1-C(FBH1920B) FBB26N-C, FBB26N-1-C(FBH2526B)
CCMT0602□□L	BCC28(DBC2528S),BCC35(DBC3235S), FBB33N-C, FBB33N-1-C(FBH3233B), FBH42N-C, FBH42N-1-C(FBH4042B), FBH53N-1-C(FBH5053B)
CCGT0602□□L	
CPMT0602□□L	BH410(BSA38,BSA42)
CPMT0803□□L	BH413(BSA50)
CCMT09T3□□L	
CCGT09T3□□L	BCC46(DBC4046S),BCC58(DBC5058S), FBB53N-C, FBH53N-1-C09(FBH5053B), FBB68N-C, FBB68N-C09, FBB68N-1-C09(FBH6368B, FBH6398B, FBH8098B), FBB130-C09(FBC130,FBC175,FBC220,FBC265,FBC310,FBC385,FBC460)
CPMT0909□□	BH416(BSA62)
CCMT1204□□L	
CCGT1204□□L	BCC74(DBC6374S),BCC94(DBC8094),BCC120(DBC120S), BCC1348(TBC130,TBC175,TBC220,TBC265), BCC1354(TBC310,TBC385,TBC460) FBB130-C12(FBC130,FBC175,FBC220,FBC265,FBC310,FBC385,FBC460)
CPMH1204□□	BH419(BSA72,BSA90)
WBG0601□□L	BB16-5(S)(SMH4022)
TBGT0601□□L	BB16-7(S), BB18-7(S)(KMB6336,SMB4022) FZ10-28-3(S),FZ10-32-3(S)(BSA30) FZ12-36-3(S),FZ12-40-3(S)(BSA38) FF10-30(S)(BCF2530),FF12-39(S)(BCF3239)
TPGT0802□□L	
TPGW0802□□	BB16-9(S)(SMH4022),BB18-9(S)(KMB6336,SMB4022) BH408(BSA25, BSA28), FBB20N,FBB20N-1(FBH1920B), FBB26N,FBB26N-1(FBH2526B), FBB33N,FBB33N-1(FBH3233B), FBB42N, FBB42N-1(FBH4042B) FZ16-45-3(S),FZ16-50-3(S)(BSA42) FZ20-56-3(S),FZ20-64-3(S)(BSA50) FF16-47(S)(BCF4047), FF20-58(S)(BCF5058)
TPGT1103□□L	FBB42N-T11,FBB42N-1-T11(FBH4042B), FBB53N-11, FBB53N-1-T11(FBH5053B) FBB68N-11,FBB68N-1-T11(FBH6368B, FBH6398B, FBH8098B) FBB130-T11(FBC130,FBC175,FBC220,FBC265, FBC310,FBC385,FBC460) BB16-11(S),15(S),19(S)(SMH4022) BB18-11(S),13(S),15(S),17(S)(KMB6336,SMB4022) FZ25-72-3(S),FZ25-80-3(S)(BSA62) FZ32-90-3(S), FZ32-100-3(S)(BSA72) FZ32-110-3(S),FZ32-125-3(S)(BSA90) FF25-79(S)(BCF6379,BCF250FS,BCF350FS), FF32-100(S)(BCF100), FF32-138(S)(BCF138,BCF170,BCF190,BCF210,BCF230)
TPGT1604□□L	BB16-19(S)(SMH4022)
CPMH1604□□	BH425(BSA105)

Chuck

Arbor / Modular

Boring tool

Angular head

cBN/PCD

Smart factory

TAUMAX

OTHER



Angular head

DINOX NC TOOLING SYSTEM

ANGULAR HEAD	198
SAH	201
MAH	202
KHU	204
HRAG	206
KAG	208
KAH	210
KAC	212
POSITIONING BLOCK	214



ANGULAR HEAD

Angular head



MAH

Rigidity-reinforced side lock type MAH (Reinforced series) / Angle adjustment type angular head



MAH that supports mold machining by improving the performance of the current universal-type product

- Stable machining of large-sized mold
- Supports ball endmill 32mm in diameter (D)
- Improves the rigidity of the KHU type



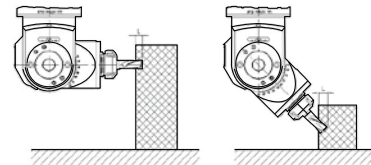
KHU

Collet type KHU (Free angle) / Angle adjustment type angular head



Wide machining angle range from 0° to 90°

- HSK and SK types are customizable.



BT50-KHU20-195



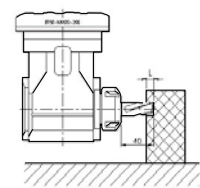
KAH

Modular type KAH (90° type) / Fixed angle-type angular head



Availability in adjusting horizontal machining angle up to 360°.

- To use Tap-exclusive collet, please contact us in advance.
- HSK and SK types are customizable



BT50-KAH20-200



ANGULAR HEAD

Angular head



HRAG

Attachment type HRAG (Reinforced type) / Attachment-type angular head



HRAG that improves the rigidity of the attachment-type bracket by 200%

- Provides stable operation of the face mill cutter
- Improves the rigidity of the KAG type



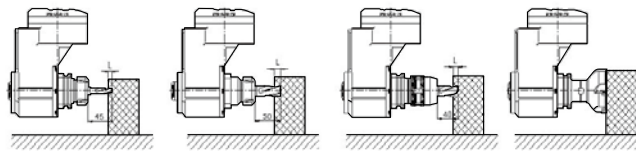
KAG

Attachment type KAG / Attachment-type angular head



Wide horizontal machining angle range from 0° to 360°

- Compatible with various tools for BT40 and BT30.
- HSK and SK types are customizable.



KAC

Modular type KAC (45° type) / Fixed angle-type angular head



Availability in adjusting horizontal machining angle up to 360°.

- HSK and SK types are customizable.

Chuck

Arbor / Modular

Boring tool

Angular head

cBN/PCD

Smart factory

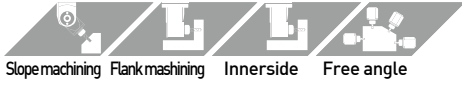
TAUMAX

OTHER



ANGULAR HEAD

Angular head



Slope machining Flank machining Innerside Free angle

Features

- Effect of two machines with one
- Various angle machining available
- Light aluminium body

MAINING

BT50	—	KHU	—	10	—	195
Spindle		Angular Head		Tool Dia.		Length

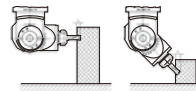


Names of each part

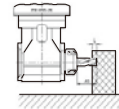


Various machinings

0°-90° slope angle adjustment angular head (MAH, KHU)



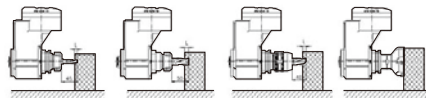
Fixed slope angle 90-degree type angular head (KAH)



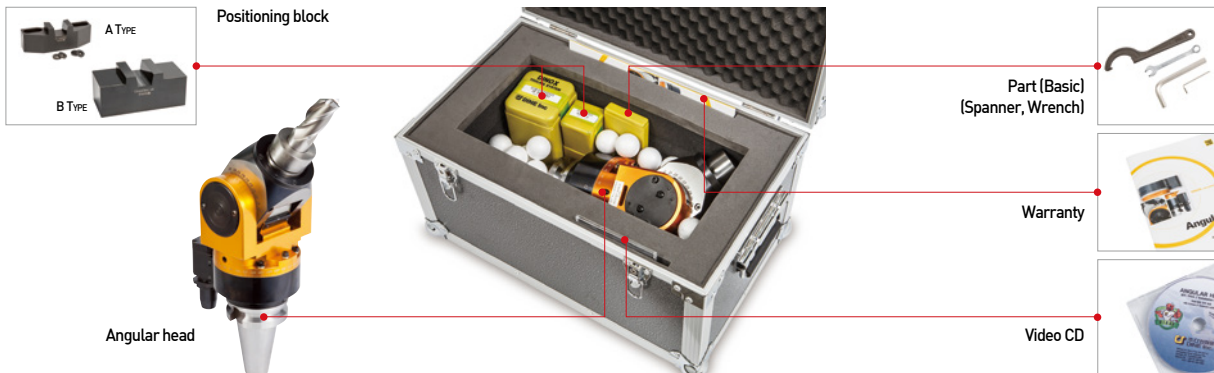
Fixed slope angle 45-degree type angular head (KAC)



Attachment-type angular head (HRAG, KAG)



Components





BT-SAHA

Slim Angular Head



MAS 403-BT	3,500				
Shank	Max RPM	Milling	Drilling	Flank mashing	Inner side mashing

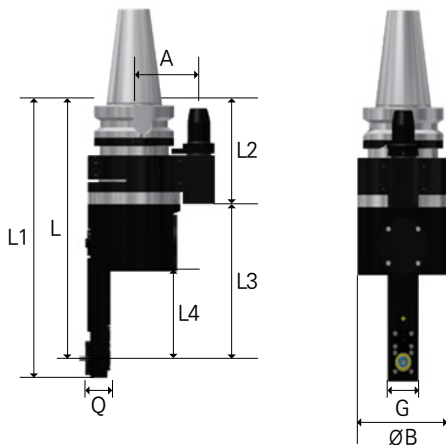
Features

- Angular head for narrow inside boring (min. inner diameter of workpiece: $\varnothing 40$, min. boring width: 32mm)
- MAX 3,500RPM, Spindle: applied rotation ratio = 1:1.37
- Boring range: $\varnothing 3$, $\varnothing 4$, $\varnothing 6$

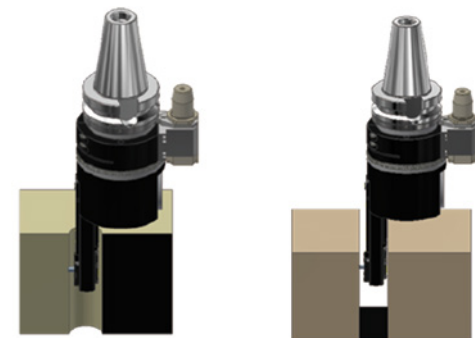
NAMING

BT50	—	SAH	—	6	—	277
Spindle		Slim Angular head		Tool Dia.		Length

Details



Machining Features



Min. $\varnothing 40$ Hole (except tool projection)

Min. 32mm gap (except tool projection)

Item	L	L1	L2	L3	L4	A	Q	G	$\varnothing B$	Rotation ratio (IN:OUT)	Rotation direction	MAX RPM	Weight (Kg)
BT50-SAHA6-277	277	298	183.5	166.5	93.5	80(110)	31.5	40	76	1:1.37	CW:CCW	3,500	14

Clamping Force

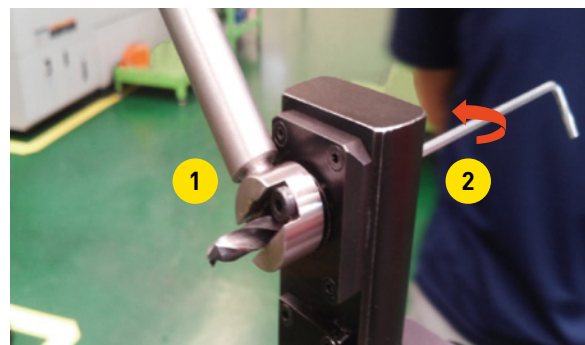
	Measurement	Measured value (N-m)			
Clamp torque	2	2.5	3	3.5	4
Clamping Force	Not measurable	5.5	6.5	7	7

※ The moderate clamp torque of collet is 3.5N-m.

Exclusive collet

	Model No.	Clamping Range
	SAH6-C3	3
	SAH6-C4	4
	SAH6-C6	6

How to clamp



1. Couple the tool with SAH dedicated collet
2. Insert the coupled tool into SAH and fix it with a dedicated tightening jig
3. Turn the bolt using a hexagonal wrench



BT-MAH

MAH for mold(0° - 90°)



MAS 403-BT	C	3,000	Milling	Drilling	Corner Rounding	Copy Machining	Inclined Face
Shank	Coolant System	Max RPM					

Features of rigidity reinforced type

MAH for mold machining

MAH ideal for mold machining by improving the performance of conventional universal type products

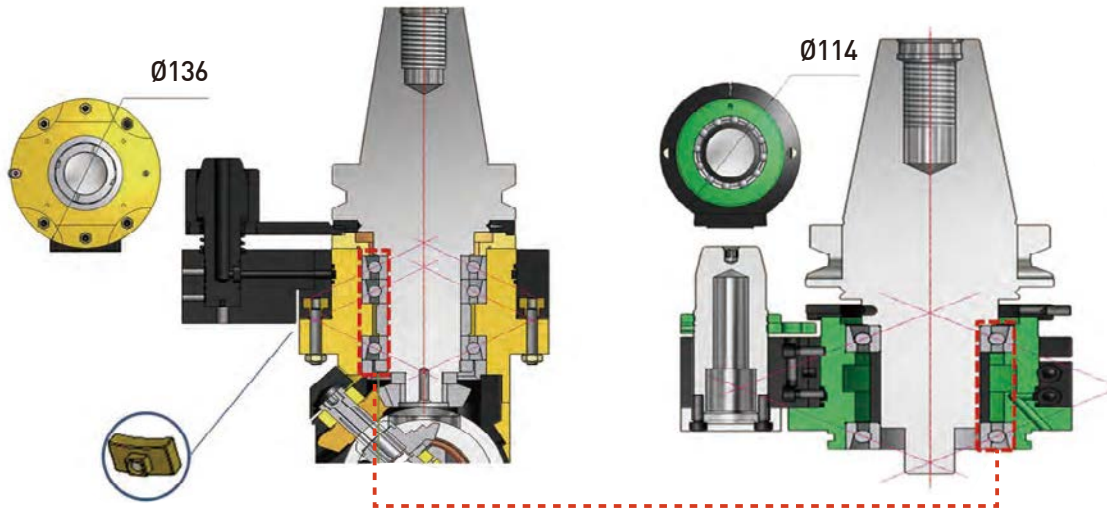
- Stability on large mold machining
- Tool diameter (D) 32mm ball end mill usable



Features of MAH (For mold machining) and its comparison with KHU

MAH

KHU



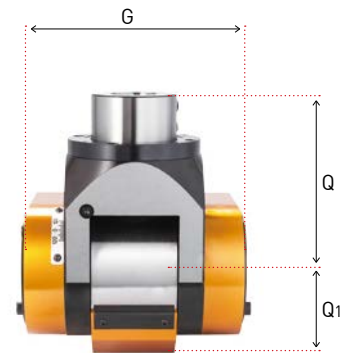
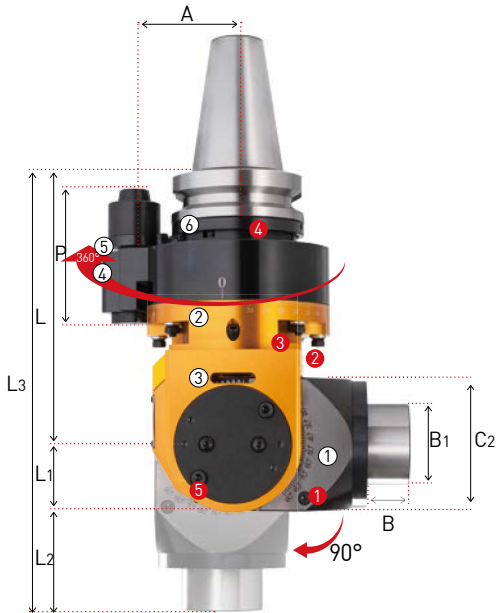
	KHU	MAH	MAH Advantages
Lock type (Joint Type)	Bolt	T-nut	Torsional strain improvement
Bearing	2pcs	3pcs	

C This product does not support the internal coolant system.

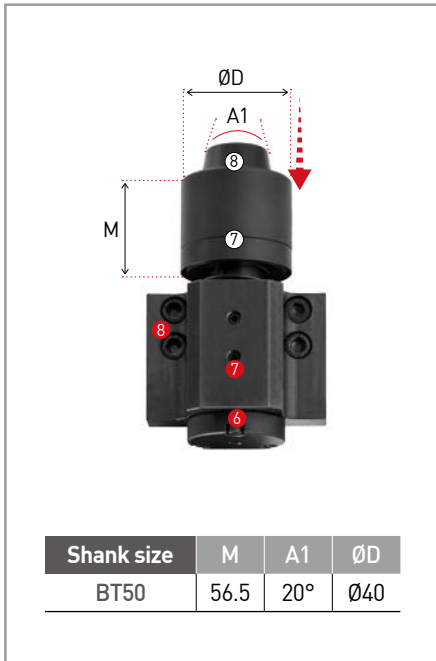


BT-MAH

MAH for mold(0° - 90°)



POSITIONING PIN



NO	Name
①	Slope angle split gradation (Angles vertically splittable between 0 and 90°)
②	Rotation angle split gradation (360° adjustment)
③	Head
④	Positioning pin part
⑤	Jaw key
⑥	Positioning ring
⑦	Positioning cover
⑧	Positioning pin

NO	Parts name	Model No.
①	Slope angle split gradation screw	BT1216
②	Head fixing bolt	BT0645
③	Rotation angle split gradation screw	BT0640
④	Positioning ring set screw	MSST5-12
⑤	Tilt Axes fixing bolt	BH0616
⑥	Positioning pin height adjustment screw	BT0516
⑦	Positioning pin set screw	BT0512
⑧	Body position block set blo	BX0516

Model No.	ØD	L	L1	L2	L3	C	C1	G	C2	Q	Q1	B	B1	P	A	MAX RPM	Tool mounting	Kg	Package weight (Kg)
BT50-MAH32-200	32	200	47	78	325	136	95	54	95	125	63	31	60	95	80	3,000	SIDE LOCK	19.6	32.0

• For more information on positioning block, see **214p**



BT-KHU

KHU_Collet type angular head (0°-90°)



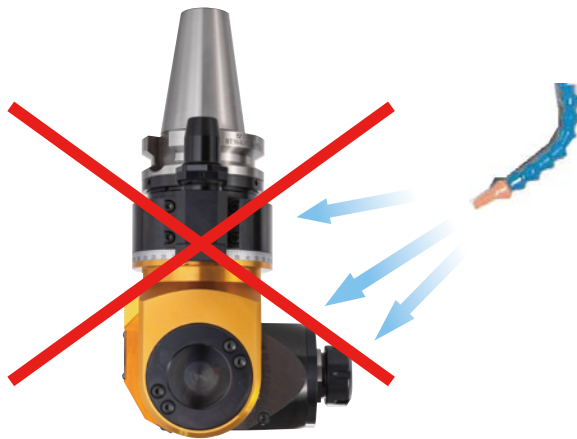
KHU

Adjustable angle-type angular head that enables flexible machining

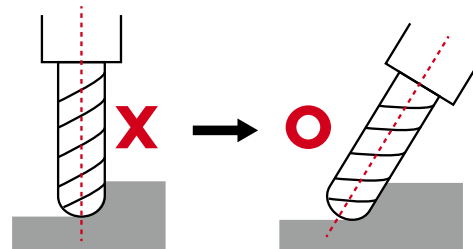
- Wide vertical (0°~90°) and horizontal (0°~360°) machining angle range
- To use Tap-exclusive collet, please contact us in advance.
- HSK and SK types are customizable.



Precautions



Do not inject cutting oil direct to the angular head body.



Be sure to give a slope to the cutting edge of a ball end mill when machining it as the ball end mill edge is worn out and the surface roughness of the workpiece becomes defective.

Machining Example

Model : BT50-KHU20-195

Cutting tool	Workpiece	Cutting depth	RPM	Feed (mm/rev)	Feed (mm/rev)	Cutting angle
Ø16-2 Flute Endmill(HSS), Over length-40mm	S45C	2	600	48	0.04	90°
	AL	3	1200	168	0.07	
	S45C	3	600	48	0.04	45°
	AL	5	1200	144	0.06	

Spare Part

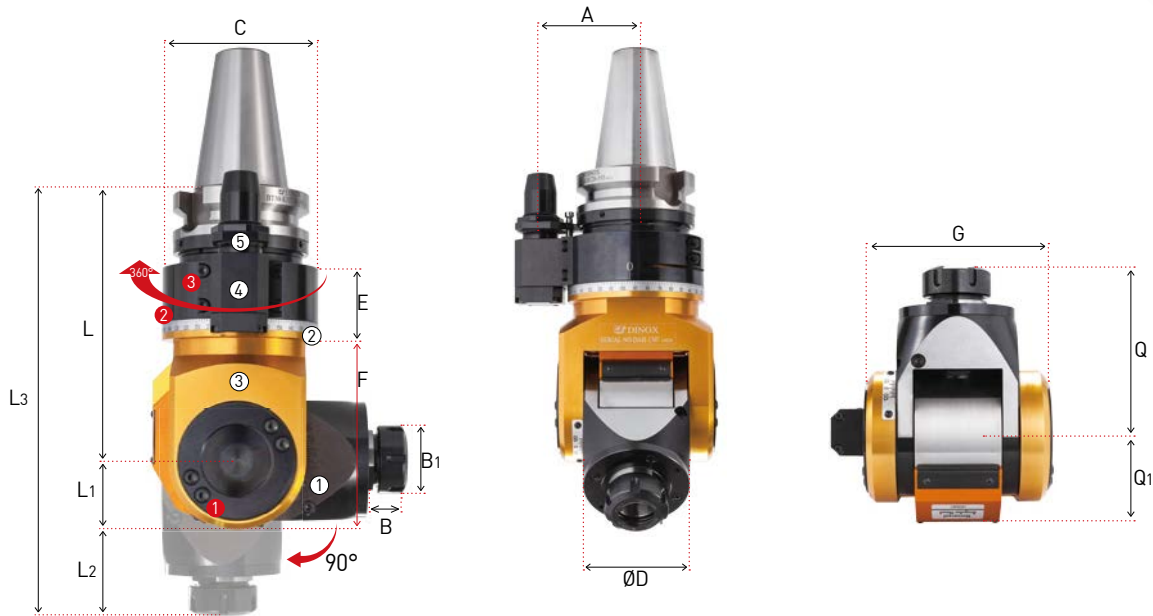
Angular head	Main components		For separate purchase
	Nut	Spanner	GERC Collet
KHU10	R16-AH	S-25	GERC16-øD
KHU20	RU32-AH	48-52	GERC32-øD

C This product does not support the internal coolant system.

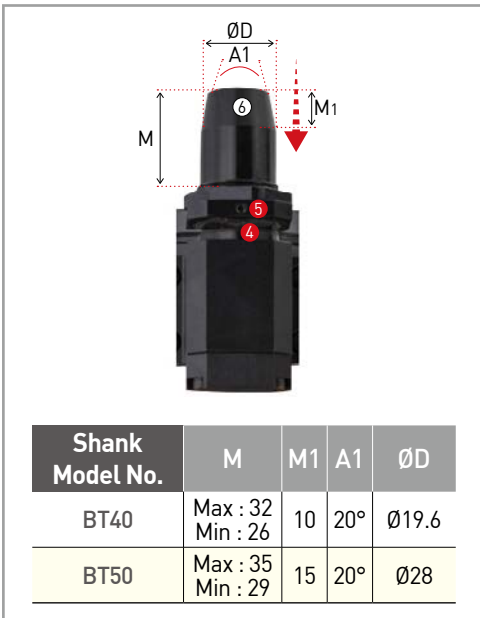


BT-KHU

KHU_Collet type angular head (0°-90°)



POSITIONING PIN



NO	Name
①	Slope angle split gradation [Angles vertically splittable between 0 and 90°]
②	Rotation angle split-gradation [360° freely selectable]
③	Head
④	Positioning pin parts
⑤	Jaw key
⑥	Height adjusting wrench hole

NO	Parts name	Model No.
①	Tilt Axes fixing bolt	BH0630
②	Bracket angle fixing bolt	BX0630
③	Position block fixing bolt	BX0512
④	Set screw	BT0404
⑤	Fixing bolt	BX05630

Model No.	ØD (Clamping Range)	B	B1	C	E	F	C2	L1	L2	L3	L	ØD	A	G	Q	Q1	Gear ratio	Rotation direction versus spindle	MAX RPM	Applicable collet	Kg	Package weight (Kg)
BT40-KHU10-160	1.0~10.0	22	28	96	51	98	96	160	33	54	247	58	65	90	87	40	1:2	Normal rotation	6,000	GERC16	8.3	15.2
BT50-KHU10-180	1.0~10.0	22	28	114	53	103	114	180	33	54	267	84	80	90	87	40	1:2	Normal rotation	6,000	GERC16	11.5	23.9
BT50-KHU20-195	1.0~20.0	29	50	114	53	132	114	195	47	73	315	84	80	124	120	63	1:1	Normal rotation	3,000	GERC32	17.9	30.3

- For more information on the applicable collet, see **75p**.
- For more information on positioning block, see **214p**.



BT-HRAG

HRAG(90° fixed)



MAS 403-BT	C	3,000	Milling	Drilling	Reaming	Facing	Tapping	Side Cutter
Shank	Coolant System	Max RPM						



HRAG

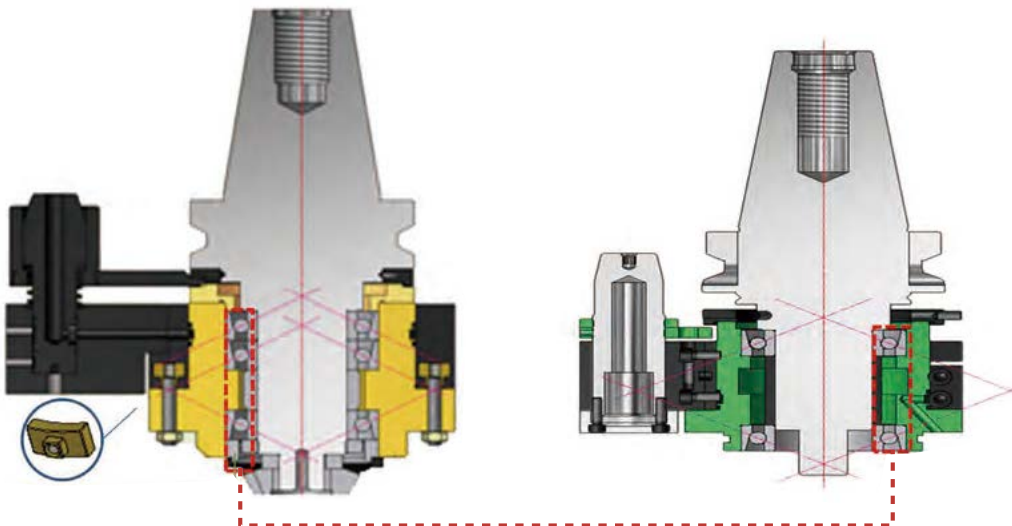
HRAG that improves the rigidity of the attachment-type bracket by 200%

- Provides stable operation of the face mill cutter
- Enhances compatibility with the machining device due to easy bracket disassembly/assembly even on the BT50 shank
- Improves product life cycle

HRAG (rigidity-reinforced type) features and comparison with KAG

HRAG

KAG



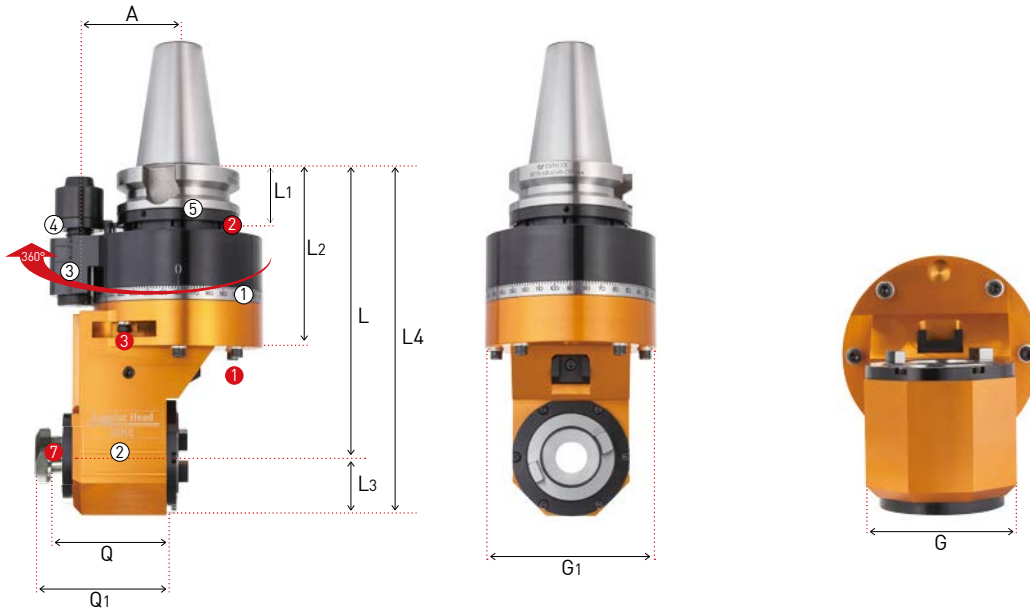
	KHU	HRAG	HRAG Advantages
Lock type (Joint Type)	Bolt	T-nut	Torsional strain improvement
Bearing	2pcs	3pcs	

C This product does not support the internal coolant system.

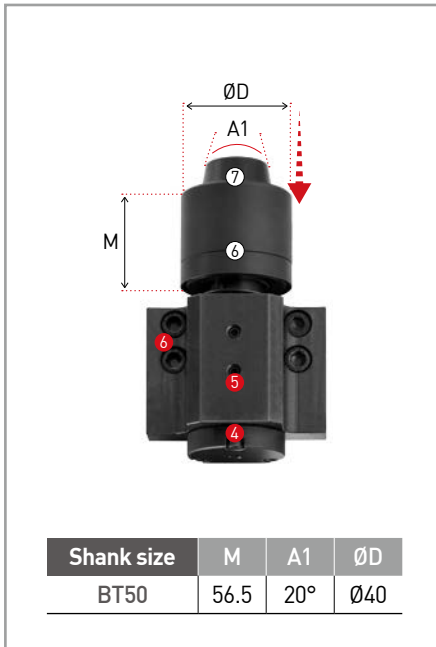


BT-HRAG

HRAG(90° fixed)



POSITIONING PIN



NO	Name
①	Rotation angle split gradation (360° adjustment)
②	Head
③	Positioning pin part
④	Jaw key
⑤	Positioning ring
⑥	Positioning cover
⑦	Positioning pin

NO	Parts name	Model No.
①	Head fixing bolt	BX0660
②	Positioning set screw	MSST5-12
③	Rotation angle split gradation screw	BT0648
④	Positioning pin height adjustment screw	BT0516
⑤	Positioning pin set screw	BT0512
⑥	Body position block set screw	BX0516
⑦	BT / NT bolt	

Model No.	L	L1	L2	Q	Q1	A	G1	G	MAX RPM	Mounting tool shank	Kg
BT50-HRAG40-230	230	56.5	145	89	101	80	136	93	3,000	BT/NT40	18.2

• For more information on positioning block, see **214p**



BT-KAG

KAG(90° Fixed type)



MAS 403-BT	C	4,000	Milling	Drilling	Reaming	Facing	Side Cutter
Shank	Coolant System	Max RPM					

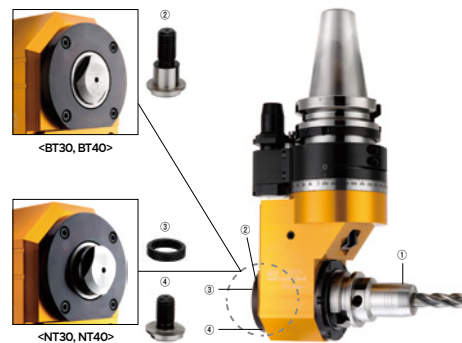


KAG

- Wide horizontal machining angle range from 0° to 360°
- Compatible with various tools such as BT40 and BT30.
- HSK and SK types are customizable.
- Coolant types are to be ordered separately.

How to tighten the tool

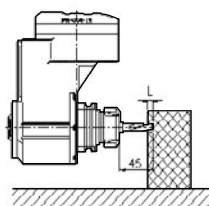
1. Insert the tool ① into the angular head spindle.
2. Tightly secure the tool ① using the fixing bolt ②. (BT type)
3. Tighten the tool ① by putting the ring on the bolt. (NT type)



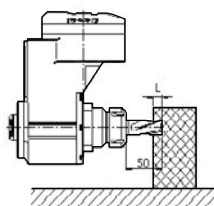
Machining Example

Model : BT50-KAG40-230

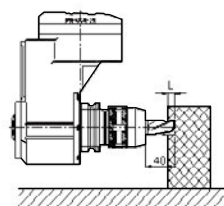
Cutting tool	Workpiece	Cutting depth	RPM	Feed (mm/rev)	Feed (mm/rev)
BT40-SDC20-60 Ø12-2 Flute Endmill (HSS)	S45C	3	400	72	0.09
		3	200	36	0.09
NT40-SDC20-60 Ø20-2 Flute Endmill (HSS)	S45C	4	500	50	0.05
	AL	10	1,000	100	0.05
BT40-NPM20-85 Ø20-2 Flute Endmill (HSS) over hang 40mm	S45C	3	400	72	0.09
		3	400	36	0.09
	AL	5	400	72	0.09
		5	480	86	0.09
		10	400	72	0.09
		10	320	58	0.09
BT40-FMA25.4-45 Ø80 Shoulder mill (5 Flute-50L)	S45C	2	400	120	
		1	200	60	
	AL	2	600	150	
		1	600	150	



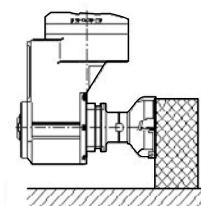
BT40-SDC20-60
(Ø12 E/M)



NT40-SDC20-60
(Ø20 E/M)



BT40-NPM20-85
(Ø20 E/M)



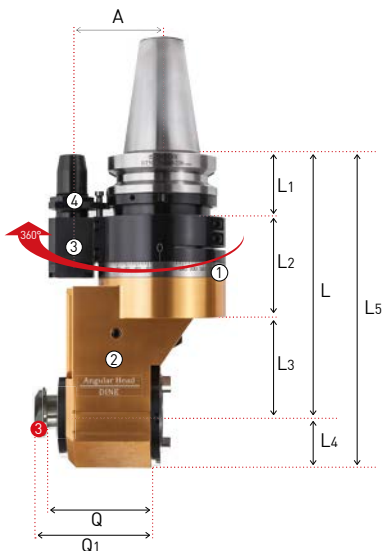
BT40-FMA25.4-45
(Ø80 Shoulder Mill)

C This product does not support the internal coolant system.

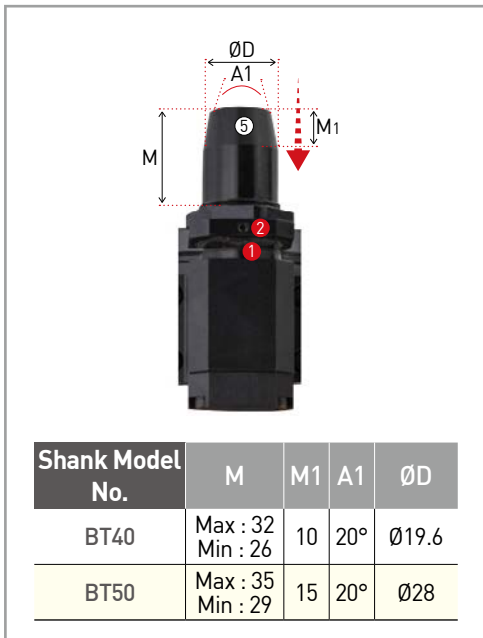


BT-KAG

KAG(90° Fixed type)



POSITIONING PIN



NO	Name
①	Rotation angle split-gradation (360° freely selectable)
②	Head
③	Positioning pin part
④	Jaw key
⑤	Height adjusting wrench hole

NO	Parts name	Model No.
①	Set screw	BT0404
②	Fixing bolt	BX50630
③	BT / NT bolt	

Model No.	L	L1	L2	L3	L4	Q	Q1	A	C	G	Gear ratio	Rotation direction versus spindle	MAX RPM	Holder shank mounted	Kg	Package weight (Kg)
BT40-KAG30-195	195	44	86	65	37.5	66	70	65	96	75	1:1	Normal rotation	4,000	BT/NT30	7.2	14.0
BT50-KAG40-230	230	57	88	85	46.5	89	94	80	114	93	1:1	Normal rotation	3,000	BT/NT40	15.7	28.1

• For more information on positioning block, see **214p**.



BT-KAH

KAH_Collet type angular head (90° fixed type)



KAH

Adjustable angle-type angular head that enables flexible machining

- Adjusting angle up to 360°.
- To use Tap-exclusive Collet, please contact us in advance.
- HSK and SK types are customizable.



Coolant

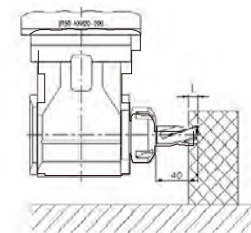
- ATC (automatic tool change) available
- The tool turns in the opposite direction of the spindle.
- Do not inject cutting oil direct to the angular head body.



Machining Example

Model : BT50-KAH20-200

Cutting tool	Workpiece	Machining depth	RPM	Feed (mm/min)	Feed (mm/rev)
Ø16-2 Flut Endmill(HSS), Over length -40mm	(rpm)	3	700	98	0.07
		4	500	60	0.06
	Al	7	900	72	0.04
		4	1800	144	0.04



BT50-KAH20-200

Spare Part

Angular head	Main Components		Components Not Included
	Nut	Spanner	
KAH7	R11-AH	S-17	GERC Collet
KHU10	R16-AH(M20)	S-25	GERC11-øD
KAH13	RU20-AH	35-38	GERC16-øD
KHU20	RU32-AH	48-52	GERC20-øD
			GERC32-øD

C This product does not support the internal coolant system.



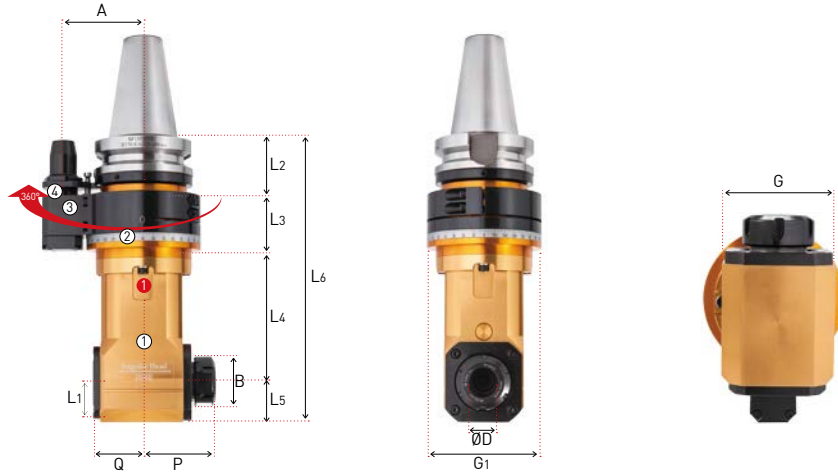
BT-KAH

KAH_Collet type angular head (90° fixed type)



MAS 403-BT C 5,000

Shank Coolant System Max RPM Milling Drilling Free angle Inner side mashing



POSITIONING PIN



Shank Model No.	M	M1	A1	ØD
BT40	Max : 32 Min : 26	10	20°	Ø19.6
BT50	Max : 35 Min : 29	15	20°	Ø28

NO	Name
①	Head
②	Rotation angle split-gradation (360° freely selectable)
③	Positioning pin parts
④	Jaw key
⑤	Height adjusting wrench hole

NO	Parts name	Model No.
①	Bolt for fixing the head	BX0618
②	Set screw	BT0404
③	Fixing bolt	BX50630

Model No.	ØD	L	L1	L2	L3	L4	L5	L6	B	A	P	Q	G	G1	Gear ratio	MAX RPM	Applicable collet	Kg
BT40-KAH7-170	1.0~7.0	170	20	44	71	55	20	190	19	65	37	24.5	40	96	1:1	5,000	GERC11	4.6
BT40-KAH10-195	1.0~10.0	195	25	44	71	80	25	220	28	65	46	32	58	96	1:1	5,000	GERC16	5.8
BT40-KAH13-165	1.0~13.0	165	28	44	71	50	28	193	35	65	53	35	60	96	1:1	5,000	GERC20	5.7
BT40-KAH20-180	2.0~20.0	180	38	44	71	65	38	218	50	65	71	49	76	96	1:1	3,500	GERC32	6.7
BT50-KAH07-220	1.0~7.0	220	20	57	54	109	20	240	19	80	37	24.5	40	96	1:1	3,500	GERC11	9.8
BT50-KAH10-215	1.0~10.0	215	25	57	54	104	25	240	28	80	46	32	58	96	1:1	3,500	GERC16	10.7
BT50-KAH10-260	1.0~10.0	260	25	57	54	149	25	285	28	80	46	32	58	96	1:1	3,500	GERC16	11
BT50-KAH13-260	1.0~13.0	260	28	57	54	149	28	288	35	80	53	35	60	96	1:1	3,500	GERC20	11.2
BT50-KAH20-200	2.0~20.0	200	38	57	54	89	38	238	50	80	71	49	76	96	1:1	3,500	GERC32	11.6
BT50-KAH20-240	2.0~20.0	240	38	57	54	129	38	278	20	80	71	49	76	96	1:1	3,500	GERC32	12.4

• For more information on positioning block, see **214p**.



BT-KAC

Modular type KAC(45° Fixed type)



MAS 403-BT	C	5,000		
Shank	Coolant System	Max RPM	Slope machining	Milling

KAC

Fixed angle type angular head that enables flexible machining

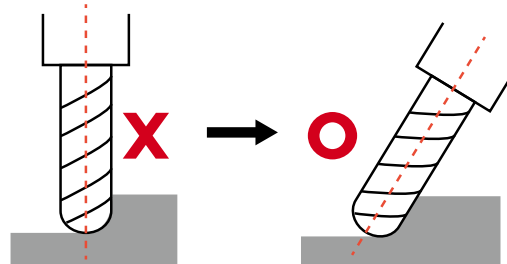
- Adjusting angle up to 360°.
- To use Tap-exclusive Collet, please contact us in advance.
- 45-degree fixed type angular head
- For BT40 types, please contact us separately.



Precautions



Do not inject cutting oil direct to the angular head body.



Be sure to give a slope to the cutting edge of a ball end mill when machining it as the ball end mill edge is worn out and the surface roughness of the workpiece becomes defective.

Spare Part

Chuck	Main Components		Components Not Included
	Nut	Spanner	
KAC10	R16-AH (M20)	S-25	GERC Collet GERC16-øD
KAC10	RU20-AH	35-38	GERC20-øD
KHU20	RU32-AH	48-52	GERC32-øD

※ To order nuts, please contact us in advance.

C This product does not support the internal coolant system.



BT-KAC

Modular type KAC(45° Fixed type)



MAS 403-BT
C
5,000
Slope machining
Milling

Shank Coolant System Max RPM Slope machining Milling



POSITIONING PIN

Shank Model No.	M	M1	A1	ØD
BT40	Max : 32 Min : 26	10	20°	Ø19.6
BT50	Max : 35 Min : 29	15	20°	Ø28

NO	Name
①	Head
②	Rotation angle split-gradation (360° freely selectable)
③	Positioning pin parts
④	Jaw key
⑤	Height adjusting wrench hole

NO	Parts name	Model No.
①	Bolt for fixing the head	BX0618
②	Set screw	BT0404
③	Fixing bolt	BX50630

Model No.	ØD	L	L1	L2	L3	B	G	G1	P	Q	A	MAX RPM	Applicable collet	Kg
BT50-KAC10-240	1.0~10.0	240	57	54	129	28	60	96	25	54	80	5,000	GERC16	9.7
BT50-KAC13-240	1.0~13.0	240	57	54	129	28	60	96	25	54	80	5,000	GERC20	10.7
BT50-KAC20-250	2.0~20.0	240	57	54	139	50	72	96	30	60	80	3,500	GERC32	11.7

- For more information on the applicable collet, see **75p**.
- For more information on positioning block, see **214p**.



POSITIONING BLOCK

Positioning block (For BT40)

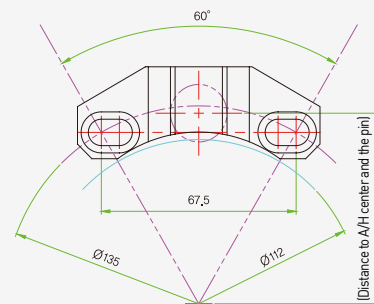
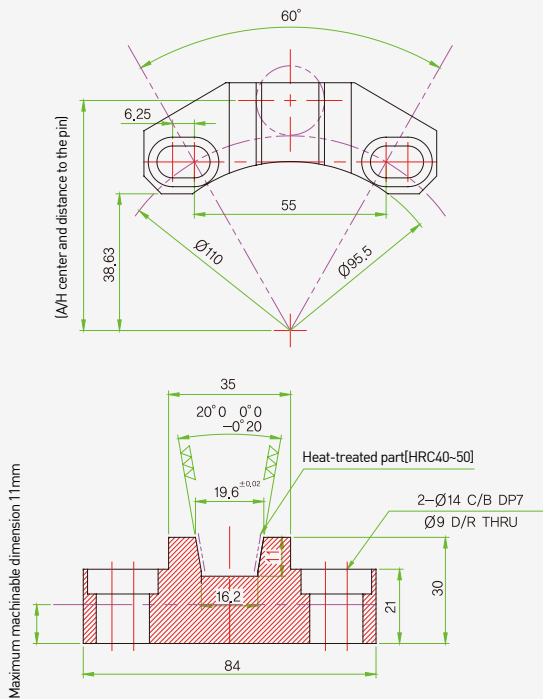
How to install the positioning block on the machine

For BT40

1. Customer standard type-A group(60°) Standard type-A(60°)

- In case Min. PCD=110mm
- Spindle diameter less than $\varnothing 94$ available
- Keep the minimum distance 55mm between bolts

- In case Max. PCD=135mm
- Spindle diameter less than $\varnothing 112$ available
- Keep the minimum distance 67.5mm between bolts

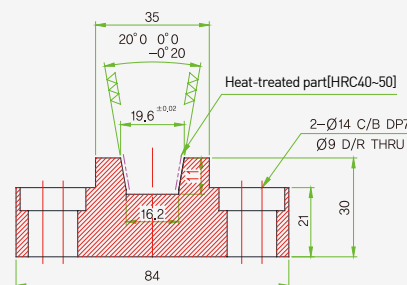
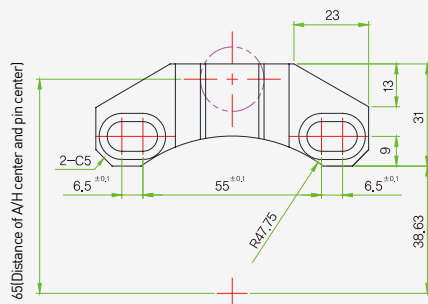


Semi-finishing : Requires block height machining

- The customer must machine the bottom of the block in person to use for use after determining the block height to avoid interference.

※ Minimum block height: 19mm (based on the upper side)

- Only the taper part to be heat-treated
- Based on M8; in the case of less than M6, washer supplied



- DINE Inc. provides two positioning block types by default.
(Customer standard type (A type) / Customized type)
- For more information on how to determine the block height, see **215p**.



POSITIONING BLOCK

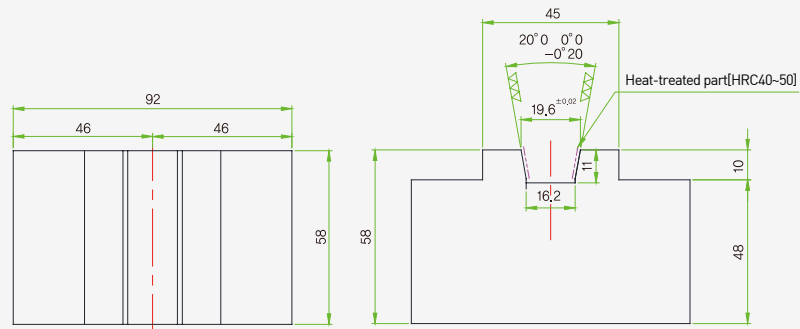
Positioning block (For BT40)

For BT40

2. Customized type

The customer directly checks the equipment spindle and determines the block height, width and hole location to avoid interference. After that, the customer directly performs machining operation for use.

Semi-Finishing (Only the taper part is heat-treated)

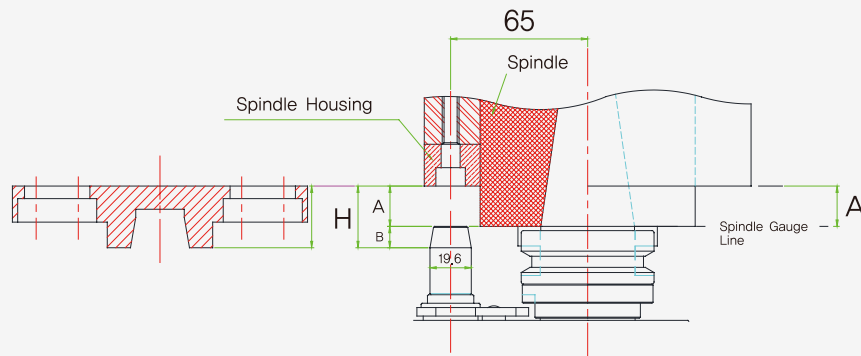


For BT40

How to determine the block height

Block height H A + B

※ Spindle housing shapes and images may vary according to equipment.



- A : The distance between spindle gauge line to spindle housing cross section for the block bottom (To be measured by the customer according to machine specs.)
- B : 10mm [BT40]

B : 10mm [BT40]

e.g.) If A is 20.5mm, the block height $H = 20.5 + 10 = 30.5\text{mm}$.

⚠ Note: Be sure to check whether the ATC is interfered before conducting a trial run after installing the positioning block



POSITIONING BLOCK

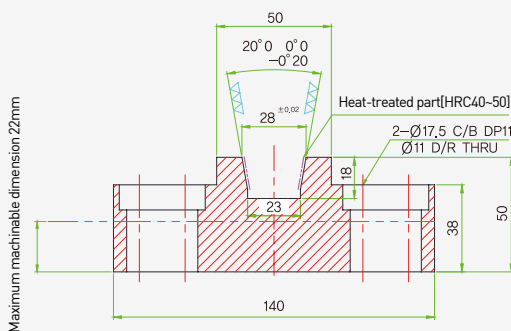
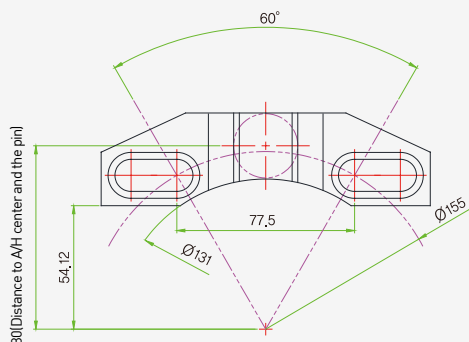
Positioning block (For BT50)

How to install the positioning block on the machine

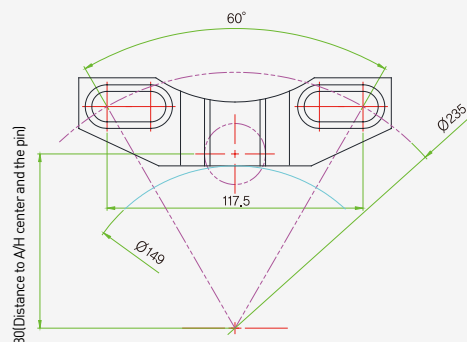
For BT50

1. Customer standard type-A group(60°) Standard type-A(60°)

- In case Min. PCD = 155
- Spindle diameter less than $\varnothing 130$ available
- Keep the minimum distance 77.5mm between bolts



- In case Max. PCD = 235
- Spindle diameter less than $\varnothing 148$ available
- Keep the minimum distance 117.5mm between bolts

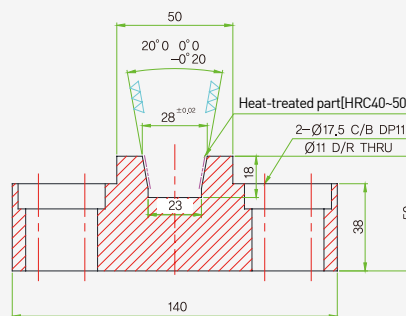
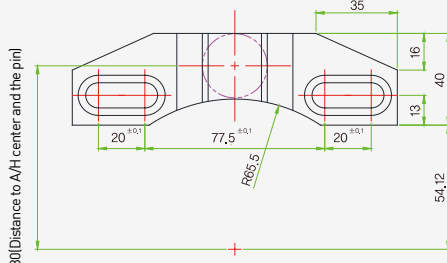


Semi-finishing : Requires block height machining

- The customer should machine the bottom of the block him/herself for use after determining the block height to avoid interference.

※ Minimum block height: 28mm (based on the upper side)

- Only the taper part to be heat-treated
- Based on M10; in the case of less than M8, washer supplied



- DINE Inc. provides two positioning block types by default.

(Customer standard type (A type) / Customized type)

- For more information on how to determine the block height, see **217p**.



POSITIONING BLOCK

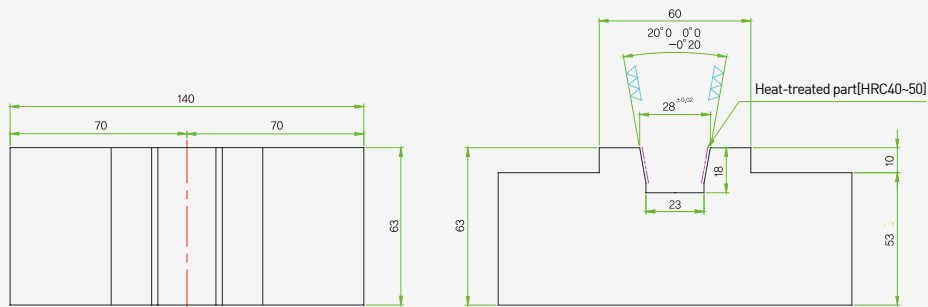
Positioning block (For BT50)

For BT50

2. Customized type

The customer directly checks the equipment spindle and determines the block height, width and hole location to avoid interference. After that, the customer directly performs machining operation for use.

Semi-Finishing (Only the taper part is heat-treated)



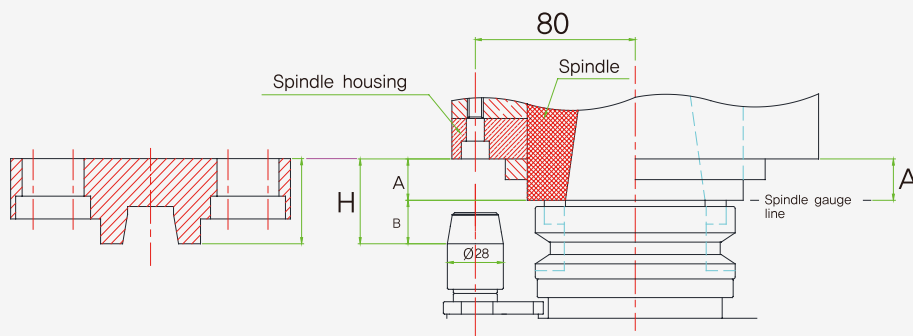
For BT50

How to determine the block height

Block height H

A + B

※ Spindle housing shapes and images may vary according to equipment.



- A : The distance between spindle gauge line to spindle housing cross section for the block bottom (To be measured by the customer according to machine specs.)
- B : 21mm [BT50]

$$H : A + 21\text{mm [BT50]}$$

e.g.) If A is 20.5mm, the block height $H = 20.5 + 21 = 41.5\text{mm}$.

⚠ Note: Be sure to check whether the ATC is interfered before conducting a trial run after installing the positioning block.

Precautions on angular head

- Make sure that all the fixing bolts for the angular head are properly tightened before starting the machine.
- Prior to the use of ATC of the machine,
 - check if conflict and interference occur between the angular head and positioning block and the machine.
 - check that the angular head is safely mounted on the tool magazine.
- Before starting the machine, check the CNC program and the status of the workpiece and also check whether or not conflict with the workpiece occurs.
- Check the rotation direction of the spindle and that of the tool. (Rotation direction check)
- Recommended hours of use : 8 hours/day
 - 30 minute rest after 2-hour operation
 - 1,500~2,000-hour durability
- Do not inject cutting oil direct to the angular head body. (Foreign substance infiltration may cause a trouble.)
- The user's arbitrary disassembly may cause a trouble, for which DINE Inc. assumes no responsibility.

Check the video for explaining product details



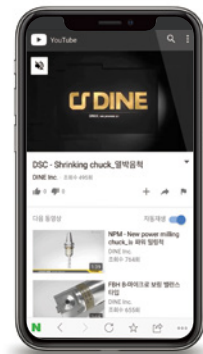
Click "Smart Lens"



Scan "QR Code"



Click "Guide Window"



Play the "Product Description" video



Angular head installation



SAH Slim Angular Head

cBN/PCD

DINOX NC TOOLING SYSTEM

cBN/PCD

How to indicate the model no. of insert (ISO)	220
CBN list	222
PCD list	226
cBN features	228
cBN heat-treated steel	232
cBN cast iron	238
cBN sintered parts	240
DNC100	242
DNC250	243
DNC300	244
DNC350	245
DNC400	246
RA,GA Chip Breaker	247
DB1000	248
DB2000	249
DB7000	250
DB7500	251
cBN technical data	252
cBN cutting edge characteristics	256
cBN re-grinding	260
PCD technical data	261
PCD Chip Breaker(UC)	264

How to indicate the model no. of insert (ISO)

C

N

G

M

1

2

3

4

Insert shape

Major clearance angle

Tolerance

Cross-sectional shape

1 Insert shape
C N G M 12 04 08 - VM

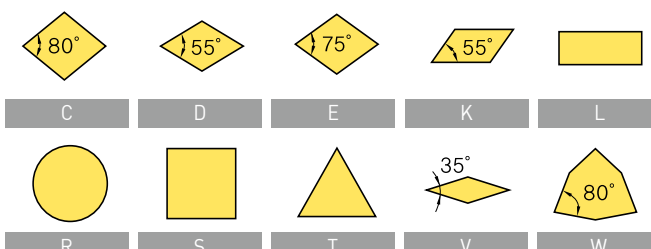


Diagram illustrating various insert shapes (C, D, E, K, L, R, S, T, V, W) and their corresponding major clearance angles (80°, 55°, 75°, 55°, 35°, 80°).

2 Major clearance angle
 C **N** G M 12 04 08 - VM

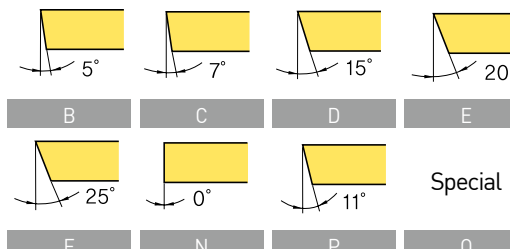
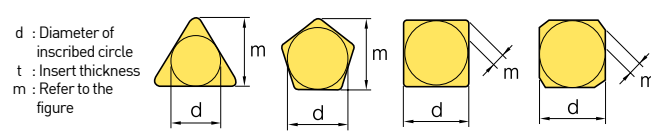


Diagram illustrating various major clearance angles (B, C, D, E, F, N, P, O) and their corresponding angles (5°, 7°, 15°, 20°, 25°, 0°, 11°, Special).

3 Tolerance
 C N **G** M 12 04 08 - VM

d : Diameter of inscribed circle
 t : Insert thickness
 m : Refer to the figure



Class	d	m	t
A	±0.025	±0.005	±0.025
C	±0.025	±0.013	±0.025
H	±0.013	±0.013	±0.025
E	±0.025	±0.025	±0.025
G	±0.025	±0.025	±0.13
J*	±0.05 ~ ±0.15	±0.005	±0.025
K*	±0.05 ~ ±0.15	±0.013	±0.025
L*	±0.05 ~ ±0.15	±0.025	±0.025
M*	±0.05 ~ ±0.15	±0.08 ~ ±0.20	±0.13
N*	±0.05 ~ ±0.15	±0.08 ~ ±0.18	±0.025
U*	±0.08 ~ ±0.25	±0.13 ~ ±0.38	±0.13

* Side is the one of the sintered parts

Tolerance definition of C, H, R, T, and W types of inscribed circle (Exceptions)

d	Tolerance of d		Tolerance of m	
	J, K, L, M, N	U	M, N	U
6.35	±0.05	±0.08	±0.08	±0.13
9.525	±0.05	±0.08	±0.08	±0.13
12.7	±0.08	±0.13	±0.13	±0.20
15.875	±0.10	±0.18	±0.15	±0.27
19.05	±0.10	±0.18	±0.15	±0.27
25.4	±0.13	±0.25	±0.18	±0.38

Tolerance definition of D-type inscribed circle (Exceptions)

d	Tolerance of d	Tolerance of m
6.35	±0.05	±0.11
9.525	±0.05	±0.11
12.7	±0.08	±0.15
15.875	±0.10	±0.18
19.05	±0.10	±0.18

4 Cross-sectional shape
 C N G **M** 12 04 08 - VM

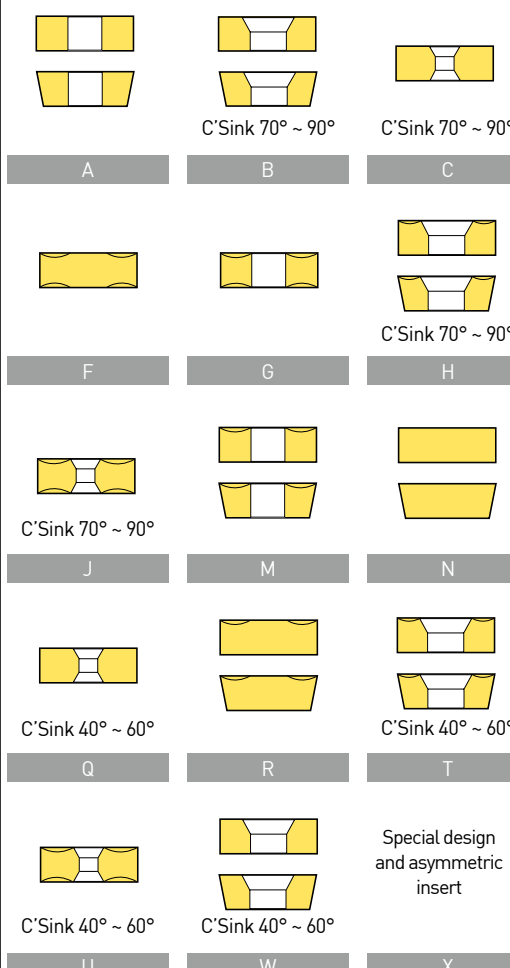


Diagram illustrating various cross-sectional shapes (A, B, C, F, G, H, J, M, N, Q, R, T, U, W, X) and their corresponding sink angles (C'Sink 70° ~ 90°, C'Sink 40° ~ 60°, C'Sink 40° ~ 60°, Special design and asymmetric insert).

12

04

08

GA

5

Cutting edge length,
Inscribed circle diameter

6

Cutting edge height

7

Nose "r" size

8

Chip breaker

5

Cutting edge length, Inscribed circle diameter

C N G M 12 04 08 - GA

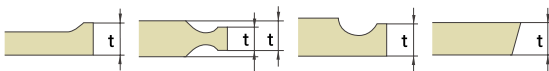
() small symbols

Symbols							Inch	IC d(mm)
C	d	S	T	R	v	W		
03	04	03	06	03	-	02	1.2(5)	3.97
04	05	04	08	04	08	S3	1.5(6)	4.76
05	06	05	09	05	09	03	1.8(7)	5.56
-	-	-	-	06	-	-	-	6.00
06	07	06	11	06	11	04	2	6.35
08	09	07	13	07	13	05	2.5	7.94
-	-	-	-	08	-	-	-	8.00
09	11	09	16	09	16	06	3	9.525
-	-	-	-	10	-	-	-	10.00
11	13	11	19	11	19	07	3.5	11.11
-	-	-	-	12	-	-	-	12.00
12	15	12	22	12	22	08	4	12.70
14	17	14	24	14	24	09	4.5	14.29
16	19	15	27	15	27	10	5	15.875
-	-	-	-	16	-	-	-	16.00
17	21	17	30	17	30	11	5.5	17.46
19	23	19	33	19	33	13	6	19.05
-	-	-	-	20	-	-	-	20.00
22	27	22	38	22	38	15	7	22.225
-	-	-	-	25	-	-	-	25.00
25	31	25	44	25	44	17	8	25.40
32	38	31	54	31	54	21	10	31.75
-	-	-	-	32	-	-	-	32.00

6

Cutting edge height

C N G M 12 04 08 - GA



Symbol		Nose "r"	
Metric	Inch	M, N	Inch
01	1(2)	1.59	1/16
T0	1.125	1.79	9/128
T1	1.2	1.98	5/64
02	1.5(3)	2.38	3/32
T2	1.75	2.78	7/64
03	2	3.18	1/8
T3	2.5	3.97	5/32
04	3	4.76	3/16
05	3.5	5.56	7/32
06	4	6.35	1/4
07	5	7.94	5/16
09	6	9.52	3/8
11	7	11.11	7/16
12	8	12.70	1/2

() small symbols

7

Nose "r" size

C N G M 12 04 08 - GA

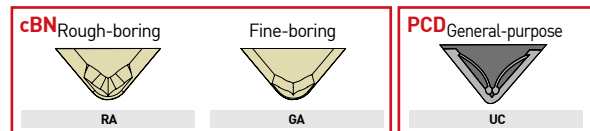


Symbol		Nose "r"	
Metric	Inch	M, N	Inch
01	0	0.1	0.004
02	0.5	0.2	0.008
04	1	0.4	1/64
08	2	0.8	1/32
12	3	1.2	3/64
16	4	1.6	1/16
20	5	2.0	5/64
24	6	2.4	3/32
28	7	2.8	7/64
32	8	3.2	1/8
00	-	Circular insert (Inch type)	
M0	-	Circular insert (Metric type)	

8

Chip breaker

C N G M 12 04 08 - GA





cBN Series

cBN Multi-corner type (Negative/positive)

※ T-2NU-□□□□△△△△△ model no. package unit is 10 EA.

Shape	Model No.	Grade										W (Weight)	mm					
		DNC100	DNC250	DNC300	DNC350	DNC400	DB1000	DB2000	DBN250	DBN350	DBN700A		DBNX20	S (cutting edge length)	IC (inscribed circle)	T (thickness)	R (Nose R)	∅D (hole diameter)
	2NU-CNGA120404	●	●	●	●	-	●	-	-	-	●	-	9.9	2.7	12.7	4.76	0.4	5.16
	2NU-CNGA120404F	-	●	-	●	-	-	-	-	-	-	-	9.9	2.7	12.7	4.76	0.4	5.16
	2NU-CNGA120404T	-	●	-	●	-	●	-	-	-	-	-	9.9	2.7	12.7	4.76	0.4	5.16
	2NU-CNGA120404W	-	●	-	-	-	-	-	-	-	-	-	9.9	2.7	12.7	4.76	0.4	5.16
	2NU-CNGA120404WF	-	●	-	-	-	-	-	-	-	-	-	9.9	2.7	12.7	4.76	0.4	5.16
	2NU-CNGA120408	●	●	●	●	-	●	●	-	-	●	-	9.9	2.6	12.7	4.76	0.8	5.16
	2NU-CNGA120408F	-	●	-	●	-	-	-	-	-	-	-	9.9	2.6	12.7	4.76	0.8	5.16
	2NU-CNGA120408T	-	●	-	●	-	●	-	-	-	-	-	9.9	2.6	12.7	4.76	0.8	5.16
	2NU-CNGA120408W	-	●	-	●	-	●	-	-	-	●	-	9.9	2.6	12.7	4.76	0.8	5.16
	2NU-CNGA120408WF	-	-	-	-	-	-	●	-	-	-	-	9.9	2.6	12.7	4.76	0.8	5.16
	2NU-CNGA120412	●	●	●	●	-	-	-	-	-	-	-	9.9	2.6	12.7	4.76	1.2	5.16
	2NU-CNGA120412F	-	●	-	●	-	-	-	-	-	-	-	9.9	2.6	12.7	4.76	1.2	5.16
	2NU-CNGA120412T	-	●	-	●	-	-	-	-	-	-	-	9.9	2.6	12.7	4.76	1.2	5.16
	2NU-CNGA120412W	-	●	-	-	-	●	-	-	-	●	-	9.9	2.6	12.7	4.76	1.2	5.16
	2NU-CNGA120412WT	-	-	-	-	-	●	-	-	-	-	-	9.9	2.6	12.7	4.76	1.2	5.16
	T-2NU-CNGA120404	-	●	-	-	-	-	-	-	-	-	-	9.9	2.7	12.7	4.76	0.4	5.16
T-2NU-CNGA120408	-	●	-	●	-	-	-	-	-	-	-	9.9	2.6	12.7	4.76	0.8	5.16	
	4NU-CNGA120404	-	●	-	-	-	-	-	-	-	-	9.85	2.7	12.7	4.76	0.4	5.16	
	4NU-CNGA120408	-	●	-	●	-	-	-	-	-	-	9.85	2.6	12.7	4.76	0.8	5.16	
	4NU-CNGA120412	-	●	-	-	-	-	-	-	-	-	9.85	2.6	12.7	4.76	1.2	5.16	
	2NU-DNGA150404	-	●	●	●	-	-	●	●	-	-	12.3	2.6	12.7	4.76	0.4	5.16	
	2NU-DNGA150404F	-	●	-	●	-	-	-	-	-	-	12.3	2.6	12.7	4.76	0.4	5.16	
	2NU-DNGA150404T	-	●	-	●	-	-	-	-	-	-	12.3	2.6	12.7	4.76	0.4	5.16	
	2NU-DNGA150408	-	●	●	●	-	●	●	●	-	-	-	12.3	2.2	12.7	4.76	0.8	5.16
	2NU-DNGA150408F	-	●	-	●	-	-	-	-	-	-	-	12.3	2.2	12.7	4.76	0.8	5.16
	2NU-DNGA150408T	-	●	-	●	-	●	●	-	-	-	-	12.3	2.2	12.7	4.76	0.8	5.16
	2NU-DNGA150412	-	●	-	●	-	-	-	-	-	-	-	12.3	2.5	12.7	4.76	1.2	5.16
	2NU-DNGA150412F	-	●	-	●	-	-	-	-	-	-	-	12.3	2.5	12.7	4.76	1.2	5.16
	2NU-DNGA150412T	-	●	-	●	-	-	-	-	-	-	-	12.3	2.5	12.7	4.76	1.2	5.16
	2NU-DNGA150604	●	●	-	●	-	-	-	-	-	-	-	15.4	2.5	12.7	6.35	0.4	5.16
2NU-DNGA150608	●	●	-	●	-	-	-	-	-	-	-	15.4	2.5	12.7	6.35	0.8	5.16	
	4NU-DNGA150404	-	●	-	●	-	-	-	-	-	-	12.13	1.8	12.7	4.76	0.4	5.16	
	4NU-DNGA150408	-	●	-	●	-	-	-	-	-	-	12.13	2.9	12.7	4.76	0.8	5.16	
	4NU-DNGA150412	-	●	-	●	-	-	-	-	-	-	12.13	3	12.7	4.76	1.2	5.16	
	4NU-DNGA150608	-	●	-	-	-	-	-	-	-	-	15.25	2.9	12.7	6.35	0.8	5.16	
	4NU-SNGA120404	-	●	-	-	-	-	-	-	●	-	9.9	3.1	12.7	4.76	0.4	5.16	
	4NU-SNGA120408	-	●	-	-	-	-	-	-	●	-	9.9	3.1	12.7	4.76	0.8	5.16	
	3NU-TNGA160404	-	●	-	●	-	●	●	-	●	-	7.2	2.5	9.525	4.76	0.4	3.81	
	3NU-TNGA160404T	-	●	-	-	-	-	-	-	-	-	7.2	2.5	9.525	4.76	0.4	3.81	
	3NU-TNGA160408	-	●	-	●	-	-	-	-	-	●	-	7.2	2.3	9.525	4.76	0.8	3.81
	3NU-TNGA160408F	-	●	-	-	-	-	-	-	-	-	-	7.2	2.3	9.525	4.76	0.8	3.81
	3NU-TNGA160408T	-	●	-	-	-	-	-	-	-	-	-	7.2	2.3	9.525	4.76	0.8	3.81
	3NU-TNGA160412	-	-	-	●	-	-	-	-	-	-	-	7.2	2.0	9.525	4.76	1.2	3.81



cBN Series

cBN Multi-corner type (Negative/positive)

※ T-2NU-□□□□△△△△△ model no. package unit is 10 EA.

Shape	Model No.	Grade										W (Weight)	mm					
		DNC100	DNC250	DNC300	DNC350	DNC400	DB1000	DB2000	DBN250	DBN350	DBN700A		DBNX20	S (cutting edge length)	IC (inscribed circle)	T (thickness)	R (Nose R)	ØD (hole diameter)
	2NU-VNGA160404	●	●	●	●	-	-	-	●	-	●	-	10.2	3.5	9.525	4.76	0.4	3.81
	2NU-VNGA160404F	-	●	-	●	-	-	-	-	-	-	-	10.2	3.5	9.525	4.76	0.4	3.81
	2NU-VNGA160404T	-	●	-	●	-	-	-	-	-	-	-	10.2	3.5	9.525	4.76	0.4	3.81
	2NU-VNGA160408	●	●	●	●	-	●	●	●	-	●	-	10.2	2.6	9.525	4.76	0.8	3.81
	2NU-VNGA160408F	-	●	-	●	-	-	-	-	-	-	-	10.2	2.6	9.525	4.76	0.8	3.81
	2NU-VNGA160408T	-	●	-	●	-	-	●	-	-	-	-	10.2	2.6	9.525	4.76	0.8	3.81
	T-2NU-VNGA160408	-	●	-	-	-	-	●	-	-	-	-	10.2	2.6	9.525	4.76	0.8	3.81
	2NU-CCGW060202	-	●	-	-	-	-	-	-	-	-	0.9	2.8	6.35	2.38	0.2	2.8	
	2NU-CCGW060202T	-	●	-	-	-	-	-	-	-	-	0.9	2.8	6.35	2.38	0.2	2.8	
	2NU-CCGW060204	-	●	-	-	-	-	●	-	-	-	0.9	2.7	6.35	2.38	0.4	2.8	
	2NU-CCGW060204F	-	●	-	-	-	-	-	-	-	-	0.9	2.7	6.35	2.38	0.4	2.8	
	2NU-CCGW060204T	-	●	-	-	-	-	-	-	-	-	0.9	2.7	6.35	2.38	0.4	2.8	
	2NU-CCGW060208	-	-	-	-	-	●	-	-	-	-	0.9	2.6	6.35	2.38	0.8	2.8	
	2NU-CCGW09T302	-	●	-	-	-	-	-	-	-	-	4.6	2.7	9.525	3.97	0.2	4.4	
	2NU-CCGW09T304	●	●	-	●	-	●	-	●	-	●	-	4.6	2.7	9.525	3.97	0.4	4.4
	2NU-CCGW09T304T	-	●	-	-	-	-	-	-	-	-	4.6	2.7	9.525	3.97	0.4	4.4	
	2NU-CCGW09T308	●	●	-	●	-	●	●	-	●	-	4.6	2.6	9.525	3.97	0.8	4.4	
	2NU-CCGW09T308T	-	●	-	-	-	-	-	-	-	-	4.6	2.6	9.525	3.97	0.8	4.4	
	2NU-CCGW09T308W	-	●	-	-	-	-	-	-	-	-	4.6	2.6	9.525	3.97	0.8	4.4	
		2NU-DCGW070204	-	●	-	-	-	●	-	-	-	-	1.3	2.6	6.35	2.38	0.4	2.8
2NU-DCGW070208		-	●	-	-	-	-	-	-	-	-	1.3	2.2	6.35	2.38	0.8	2.8	
2NU-DCGW070208T		-	-	-	-	-	●	-	-	-	-	1.3	2.2	6.35	2.38	0.8	2.8	
2NU-DCGW11T302		-	●	-	-	-	-	-	-	-	-	4.8	2.6	9.525	3.97	0.2	4.4	
2NU-DCGW11T304		●	●	-	●	-	●	-	●	-	-	4.8	2.6	9.525	3.97	0.4	4.4	
2NU-DCGW11T304F		-	●	-	-	-	-	-	-	-	-	4.8	2.6	9.525	3.97	0.8	4.4	
2NU-DCGW11T304T		-	●	-	-	-	-	-	-	-	-	4.8	2.6	9.525	3.97	0.4	4.4	
2NU-DCGW11T308		●	●	-	●	-	-	●	-	●	-	4.8	2.2	9.525	3.97	0.8	4.4	
2NU-DCGW11T308T		-	●	-	-	-	-	-	-	-	-	4.8	2.2	9.525	3.97	0.8	4.4	
T-2NU-DCGW11T304		-	●	-	-	-	-	-	-	-	-	4.8	2.6	9.525	3.97	0.4	4.4	
T-2NU-DCGW11T308		-	●	-	●	-	-	-	-	-	-	-	-	-	-	-	-	
	3NU-TCGW090204	-	●	-	-	-	-	-	-	-	-	1.6	2.5	5.56	2.38	0.4	2.5	
	3NU-TCGW090204F	-	●	-	-	-	-	-	-	-	-	1.6	2.5	5.56	2.38	0.4	2.5	
	3NU-TCGW090204T	-	●	-	-	-	-	-	-	-	-	1.6	2.5	5.56	2.38	0.4	2.5	
	3NU-TPGW110304	-	●	-	●	-	●	●	-	●	-	2.3	2.5	6.35	3.18	0.4	3.4	
	3NU-TPGW110304F	-	●	-	-	-	-	-	-	-	-	2.3	2.5	6.35	3.18	0.4	3.4	
	3NU-TPGW110304T	-	●	-	-	-	-	-	-	-	-	2.3	2.5	6.35	3.18	0.4	3.4	
	3NU-TPGW110308	-	●	-	●	-	●	●	-	●	-	2.3	2.3	6.35	3.18	0.8	3.4	
	3NU-TPGW110308F	-	●	-	-	-	-	-	-	-	-	2.3	2.3	6.35	3.18	0.8	3.4	
	3NU-TPGW110308T	-	●	-	-	-	-	-	-	-	-	2.3	2.3	6.35	3.18	0.8	3.4	
	3NU-TPGN110308	-	-	-	-	-	●	●	-	-	-	2.3	2.3	6.35	3.18	0.8	-	
	3NU-TPGN160304	-	●	-	-	-	-	-	-	-	-	4.8	2.5	9.525	3.18	0.4	-	
	3NU-TPGN160308	-	●	-	-	-	-	-	-	-	-	4.8	2.3	9.525	3.18	0.8	-	



cBN Series

cBN Multi-corner type (Negative/positive)

※ T-2NU-□□□□△△△△△ model no. package unit is 10 EA.

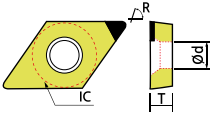
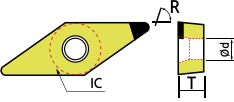
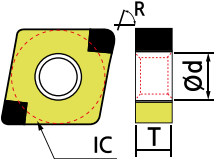
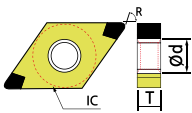
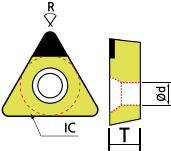
Shape	Model No.	Grade											W (Weight)	mm				
		DNC100	DNC250	DNC300	DNC350	DNC400	DB1000	DB2000	DBN250	DBN350	DBN700A	DBNX20		S (cutting edge length)	IC (inscribed circle)	T (thickness)	R (Nose R)	∅D (hole diameter)
	3NU-TPGB110304	-	●	-	-	-	-	-	●	-	-	-	2.3	2.5	6.35	3.18	0.4	3.4
	3NU-TPGB110304T	-	●	-	-	-	-	-	-	-	-	-	2.3	2.5	6.35	3.18	0.4	3.4
	3NU-TPGB110308	-	●	-	-	-	-	-	●	-	-	-	2.3	2.3	6.35	3.18	0.8	3.4
	3NU-TPGB110308F	-	●	-	-	-	-	-	-	-	-	-	2.3	2.3	6.35	3.18	0.8	3.4
	3NU-TPGB110308T	-	●	-	-	-	-	-	-	-	-	-	2.3	2.3	6.35	3.18	0.8	3.4
	2NU-VBGW160402	-	●	-	-	-	-	-	-	-	-	8.6	3.5	9.525	4.76	0.2	4.4	
	2NU-VBGW160404	●	●	-	●	-	●	-	●	-	●	8.6	3.5	9.525	4.76	0.4	4.4	
	2NU-VBGW160404F	-	●	-	-	-	-	-	-	-	-	8.6	3.5	9.525	4.76	0.4	4.4	
	2NU-VBGW160404T	-	●	-	-	-	-	-	-	-	-	8.6	3.5	9.525	4.76	0.4	4.4	
	2NU-VBGW160408	●	●	-	●	-	●	●	-	-	-	8.6	2.6	9.525	4.76	0.8	4.4	
	2NU-VBGW160408F	-	●	-	-	-	-	-	-	-	-	8.6	2.6	9.525	4.76	0.8	4.4	
	2NU-VBGW160408T	-	●	-	-	-	-	-	-	-	-	8.6	2.6	9.525	4.76	0.8	4.4	
	T-2NU-VBGW160408	-	-	-	●	-	-	-	-	-	-	-	2.6	-	-	-	-	
	2NU-VCGW160404	-	●	-	●	-	-	-	-	-	-	8.6	3.5	9.525	4.76	0.4	4.4	
	2NU-VCGW160404F	-	●	-	-	-	-	-	-	-	-	8.6	3.5	9.525	4.76	0.4	4.4	
	2NU-VCGW160404T	-	●	-	-	-	-	-	-	-	-	8.6	3.5	9.525	4.76	0.4	4.4	
	2NU-VCGW160408	-	●	-	-	-	-	-	-	-	-	8.6	2.6	9.525	4.76	0.8	4.4	
	2NU-VCGW160408F	-	●	-	-	-	-	-	-	-	-	8.6	2.6	9.525	4.76	0.8	4.4	
	2NU-VCGW160408T	-	●	-	-	-	●	●	-	-	-	8.6	2.6	9.525	4.76	0.8	4.4	
	T-2NU-VCGW160404	-	●	-	-	-	-	-	-	-	-	-	-	-	-	0.4	-	
	T-2NU-VCGW160408	-	●	-	-	-	-	-	-	-	-	-	8.6	2.6	9.525	4.76	0.8	4.4
	CNMA120404	-	-	-	-	-	-	●	-	-	-	9.89	4.5	12.7	4.76	0.4	5.16	
	CNMA120408	-	-	-	-	-	-	●	-	-	●	9.89	4.5	12.7	4.76	0.8	5.16	
	T-CNMA120408	-	-	-	-	-	-	●	-	-	-	9.89	4.5	12.7	4.76	0.8	5.16	
	DNMA150404	-	-	-	-	-	-	●	-	-	-	12.88	3.7	12.7	4.76	0.4	5.16	
	DNMA150408	-	-	-	-	-	-	●	●	-	-	12.88	3.4	12.7	4.76	0.8	5.16	
	TNMA160404	-	-	-	-	-	-	●	-	-	-	7.2	3.7	9.525	4.76	0.4	3.81	
	TNMA160408	-	-	-	-	-	-	●	-	-	-	7.2	3.5	9.525	4.76	0.8	3.81	
	T-VNMA160404	-	-	-	-	-	-	●	-	-	-	10.2	4.9	9.525	4.76	0.4	3.81	
	VNMA160404	-	-	-	-	-	-	●	-	-	-	12.9	5.8	9.525	4.76	0.4	3.81	
	VNMA160408	-	-	-	-	-	-	●	-	-	-	10.2	5.8	9.525	4.76	0.8	3.81	
	CCMW09T304	-	-	-	-	-	-	●	-	-	-	4.5	4.3	9.525	3.97	0.4	4.4	



cBN Series

cBN Multi-corner type (Negative/positive)

※ T-2NU-□□□□△△△△△ model no. package unit is 10 EA.

Shape	Model No.	Grade												W (Weight)	mm				
		DNC100	DNC250	DNC300	DNC350	DNC400	DB1000	DB2000	DBN250	DBN350	DBN700A	DBNX20	S (cutting edge length)		IC (inscribed circle)	T (thickness)	R (Nose R)	∅D (hole diameter)	
	DCGW11T308	-	-	-	-	-	-	-	●	-	-	-	4.8	3.2	9.525	3.97	0.8	4.4	
	T-DCGW11T308	-	-	-	-	-	-	-	●	-	-	-	4.8	3.2	9.525	3.97	0.8	4.4	
	VBMW160404	-	-	-	-	-	-	-	●	-	-	-	8.6	3.5	9.525	4.76	0.4	4.4	
	VBMW160408	-	-	-	-	-	-	-	●	-	-	-	8.6	3.5	9.525	4.76	0.8	4.4	
	4NS-CNGA120408	-	-	-	-	●	-	-	-	-	-	9.7	3	12.7	4.76	0.8	5.16		
	4NS-CNGA120412	-	-	-	-	●	-	-	-	-	-	9.7	2.9	12.7	4.76	1.2	5.16		
	4NS-DNGA150608	-	-	-	-	●	-	-	-	-	-	15.1	2.83	12.7	6.35	0.8	5.16		
	4NS-DNGA150612	-	-	-	-	●	-	-	-	-	-	15.1	2.46	12.7	6.35	1.2	5.16		
	T-TPGB110304	-	-	-	-	-	-	-	●	-	-	2.3	3.7	6.35	3.18	0.4	3.4		
	TPGB110304	-	-	-	-	-	-	-	●	●	-	2.3	3.7	6.35	3.18	0.4	3.4		
	TPGB110308	-	-	-	-	-	-	-	●	-	-	2.3	3.5	6.35	3.18	0.8	3.4		



PCD Series

PCD Insert (Negative/positive)

※ T-2NU-□□□□△△△△△ model no. package unit is 10 EA.

Shape	Model No.	Grade		W (Weight)	mm					
		DP150			S (cutting edge length)	IC (inscribed circle)	T (thickness)	R (Nose R)	∅D (hole diameter)	
	CNMM120404	●	-	-	4.3	12.7	4.76	0.4	5.16	
	CNMM120408	●	-	-	4.2	12.7	4.76	0.8	5.16	
	CCMW120404	●	-	-	4.3	12.7	4.76	0.4	5.16	
	DNMM150404	●	-	-	3.5	12.7	4.76	0.4	5.16	
	DNMM150408	●	-	-	3.2	12.7	4.76	0.8	5.16	
	CCMT060202	●	-	-	2.8	6.35	2.38	0.2	2.8	
	CCMT060204	●	-	-	2.7	6.35	2.38	0.4	2.8	
	CCMT09T304	●	-	-	4.3	9.525	3.97	0.4	4.4	
	CCMT09T308	●	-	-	4.2	9.525	3.97	0.8	4.4	
	DCMT070202	●	-	-	3.7	6.35	2.38	0.2	2.8	
	DCMT070204	●	-	-	3.5	6.35	2.38	0.4	2.8	
	DCMT11T302	●	-	-	3.5	9.525	3.97	0.2	4.4	
	DCMT11T304	●	-	-	3.5	9.525	3.97	0.4	4.4	
	DCMT11T308	●	-	-	3.2	9.525	3.97	0.8	4.4	
	DCGT11T304	●	-	-	3.5	9.525	3.97	0.4	4.4	



PCD Series

PCD Insert (Negative/positive)

※ T-2NU-□□□□△△△△△ model no. package unit is 10 EA.

Shape	Model No.	Grade		W (Weight)	mm			
		DP150			S (cutting edge length)	IC (inscribed circle)	T (thickness)	R (Nose R)
	TPGW080204	●	-	-	6.35	2.38	0.4	2.4
	TPGW090204	●	-	3.2	5.56	2.38	0.4	2.5
	TPGW090208	●	-	3	5.56	2.38	0.8	2.5
	TPGW110304	●	-	3.7	6.35	3.18	0.4	3.4
	TPGW110308	●	-	3.5	6.35	3.18	0.8	3.4
	VBMT110304	●	-	5.8	6.35	3.18	0.4	3.4
	VBMT110308	●	-	4.9	6.35	3.18	0.8	3.4
	VBMT160404	●	-	5.8	9.525	4.76	0.4	4.4
	VBMT160408	●	-	4.9	9.525	4.76	0.8	4.4
	VCMT110304	●	-	5.8	6.35	3.18	0.4	3.4
	VCMT110308	●	-	4.9	6.35	3.18	0.8	3.4
	VBGW160404	●	-	5.8	12.7	4.76	0.4	4.4
	VCMT160404	●	-	5.8	9.525	4.76	0.4	4.4
	VCMT160408	●	-	4.9	9.525	4.76	0.8	4.4
	TPGN110304	●	-	3.7	6.35	3.18	0.4	-
	TPGN110308	●	-	3.5	6.35	3.18	0.8	-
	SPGN090304	●	-	4.1	9.525	3.18	0.4	-

Chuck

Arbor / Modular

Boring tool

Angular head

cBN/PCD

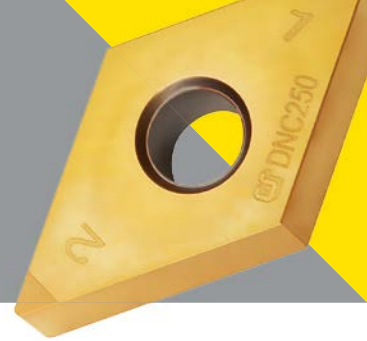
Smart factory

TAUMAX

OTHER



cBN Feature



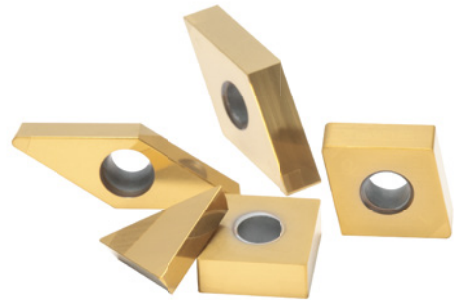
Features

DINOX cBN features very excellent hardness and thermal resistance by adding special ceramic bonding material to cBN, its main ingredient, and sintering them at an ultrahigh-pressure high temperature. It also provides optimal conditions for productivity improvement through high-speed processing of cast iron and heat-treated steel due to its excellent strength and wear resistance.

High accuracy

Wear resistance

Productivity improvement



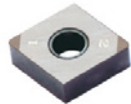
cBN Type



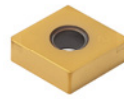
Re-polishing type



One-use type



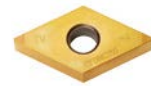
Multi-corner type



Multi-corner type (coating)

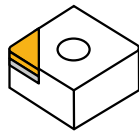


NS Type



NT Type

Re-grinding type



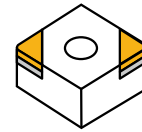
e.g.) CNGA120408

- Stable and long tool life
- Excellent wear resistance, high hardness
- 3-4 time re-polishing is possible, which reduces tool expenses

Multi-corner type (coated/non-coated)



Coated CBN

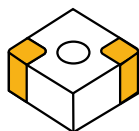
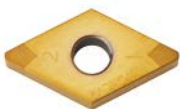


e.g.) 2NU-CNGA120408

- Simple corner management
- Strong welding surface
- Possible to create an effect of several cBNs with one insert

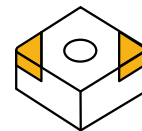
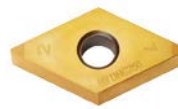
NS, NT Type

NS Type



e.g.) 4NS-CNGA120408

NT Type



e.g.) 2NT-CNGA120408

- Specialized high cutting depth
- Excellent machining performance in spite of variable cutting depth

- High cutting depth versus general brazing type
- Economical cBN

High cutting depth and high feed available; excellent machining performance in spite of variable cutting depth
Universal machining available; stable and efficient machining versus general brazing inserts



cBN Feature

Applications by grade and textural characteristics

Textural characteristics	Texture	cBN content	Grade name	Workpiece, Applications	Features
Mostly cBN particles combine by themselves		High ↑	DB7000 DB7500	Cemented carbide alloy, chilled cast iron, Ni-hard cast iron, Iron metal sintered alloy, heat-resistant alloy, cast iron	<ul style="list-style-type: none"> High cBN content and texture where cBN particles strongly combine by themselves Suitable for cutting machining of high-hardness materials such as cast iron, heat-resistant alloy, Cemented carbide alloy, etc.
Mostly cBN particles combine by means of bonding material		Low ↓	DB1000, DB2000, DBN250, DBN350, DBN500, DBNX20, DBNX25, DNC100, DNC250, DNC300, DNC350, DNC400	Alloy steel, titanium steel, carbon tool steel, bearing steel, dice steel, ductile cast iron	<ul style="list-style-type: none"> cBN particles strongly combine by special ceramic bonding material Features excellent wear resistance and tenacity in cutting heat-treated steel due to its high cBN retention capacity

Grade map


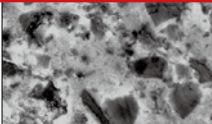
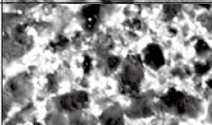
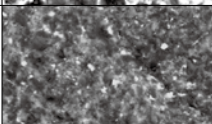
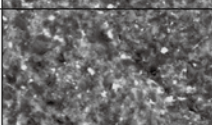
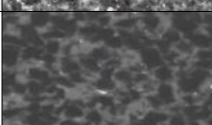
Workpiece	Type	High-speed continuous	Continuous	Low/medium interrupted	High interrupted
	Usage classification	H01	H10	H20	H30
	Coated cBN	DNC100			
			DNC250		
			DNC300 NEW		
			DNC350		
Non-coated cBN	DB1000				
		DB2000			
				DBNX20	DBNX25
	Usage classification	1	10	20	30
	Non-coated cBN	DB7500			
			DB7000		
	Usage classification	K01	K10	K20	K30
	Non-coated cBN	DBN500			
			DB7000		
			DBNS800		
	Usage classification	S01	S10	S20	S30
	Non-coated cBN	DB7000			
				DBNS800	



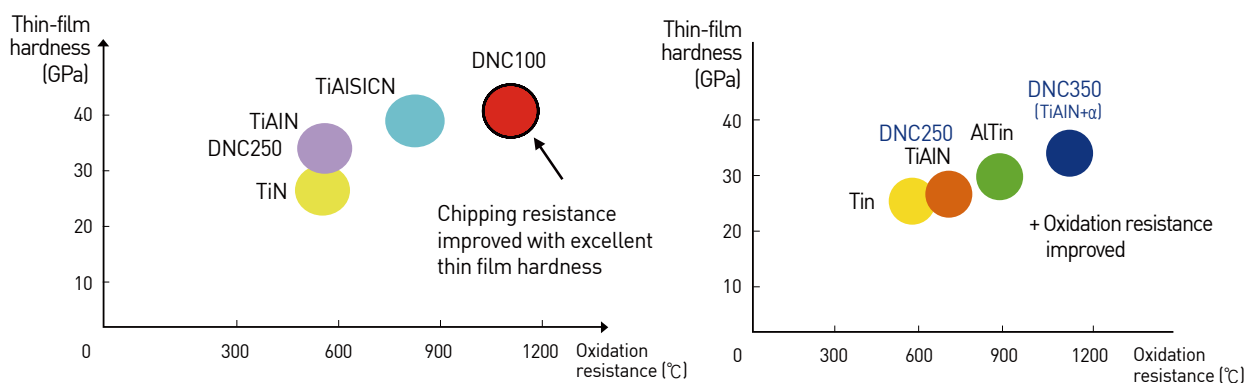
cBN Feature

Coating information

Characteristics

Classification	Grade	Texture	Binder	CBN content (%)	Grain size (μm)	Hardness HV (Gpa)
	DNC100		TiN	50 - 55	2	31 - 34
	DNC250		TiC	65 - 70	6	32 - 34
	^{NEW} DNC300		TiN	65 - 70	4	29 - 31
	DNC350		TiN	60 - 65	1	33 - 35
	DNC400		TiN	65	3	-

Coated thin-film characteristics


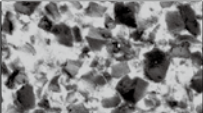
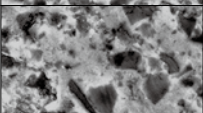
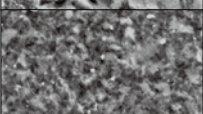
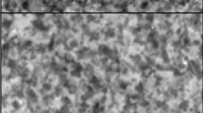
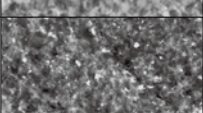
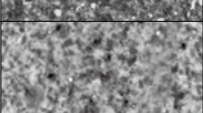

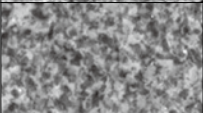
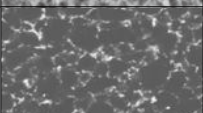

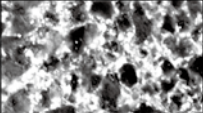
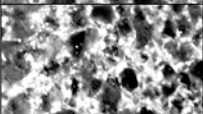


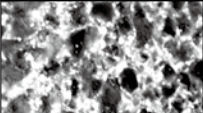
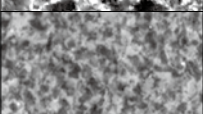




cBN Feature

Non-coating information

Characteristics

Classification	Grade	Texture	Binder	CBN content (%)	Grain size (μm)	Hardness HV (Gpa)
	DB1000		TiCN	40 - 45	1	27 - 31
	DB2000		TiN	50 - 55	2	31 - 34
	DBNX20		TiN	55 - 60	3	31 - 33
	DBNX25		TiN	65 - 70	4	29 - 31
	DBN250		TiN	50 - 55	2	31 - 34
	DBN350		TiN	60 - 65	1	33 - 35
	DB7000		CO compound	90 - 95	2	41 - 44
	DB7500		CO compound	90 - 95	1	41 - 44
	DBN500		TiC	65 - 70	6	32 - 34
	DBNS800		Al compound	85 - 90	8	39 - 42
	DB7000		CO compound	90 - 95	2	41 - 44
	DBNS800		Al compound	85 - 90	8	39 - 42
	DB7000		CO compound	90 - 95	2	41 - 44

Chuck

Arbor / Modular

Boring tool

Angular head

cBN/PCD

Smart factory

TAUMAX

OTHER



cBN Heat treated steel



Features and cutting conditions of cBN grade

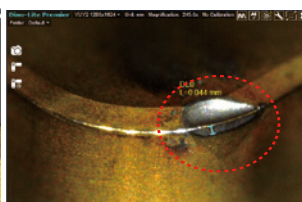
Classification	Grade		Insert color	Applications	Cutting conditions			
	Coated or non-coated	Name			Cutting speed Vc(m/min)		Feed f(mm/rev)	Cutting depth ap(mm)
	Coated	DNC100		For high-speed, continuous cutting	180	300	0.03 -0.30	0.03 -0.30
		DNC250		For continuous, low interrupted cutting	120	220	0.05 -0.30	0.05 -0.30
		DNC300		For low/medium interrupted cutting	90	250	0.05 -0.20	0.05 -0.25
		DNC350		For medium/high interrupted cutting	90	150	0.05 -0.30	0.05 -0.50
		DNC400		For low/medium interrupted cutting	80	200	0.05 -0.30	0.05 -0.50
	Non-coated	DBNX20		For high efficiency cutting	120	150	0.03 -0.30	0.03 -0.50
		DBNX25		For high-speed interrupted cutting	150	200	0.03 -0.30	0.03 -0.50
		DBN250		For low/medium interrupted cutting	80	120	0.03 -0.20	0.03 -0.30
		DBN350		For high interrupted cutting	80	110	0.03 -0.20	0.03 -0.30
		DB1000		For high-speed, continuous cutting	130	250	0.03 -0.15	0.03 -0.20
		DB2000		For low/medium interrupted cutting	80	200	0.03 -0.20	0.03 -0.30

Comparison of coated and non-coated cBNs

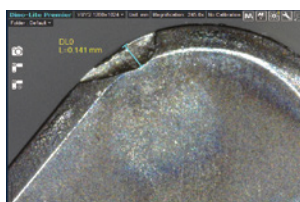
Machining information

Vc(m/min)	f(mm/rev)	ap(mm)	No. of machining ops.	Cutting distance	Workpiece	Heat treated	Hardness	Size
200	0.1	0.1	20 times	6km	SCM415 round rod	Carburizing heat treatment	58~62	Ø105*150

Wear loss (coating superior)



Coated cBN



Non-coated cBN

Surface roughness (non-coating superior)

Grade	Surface roughness		
	8 times	12 times	20 times
Non-coated cBN	Ra 0.431	Ra 0.477	Ra 0.492
Coated cBN	Ra 0.579	Ra 0.631	Ra 0.792

※The details may vary according to machining environments.



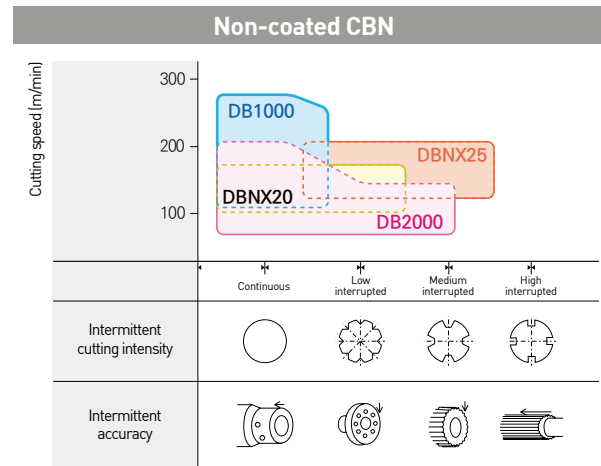
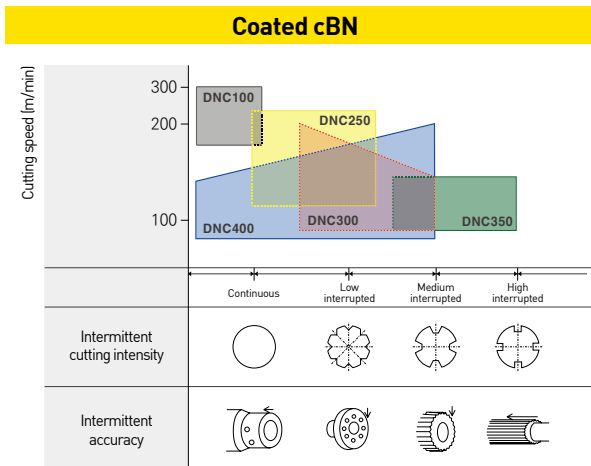
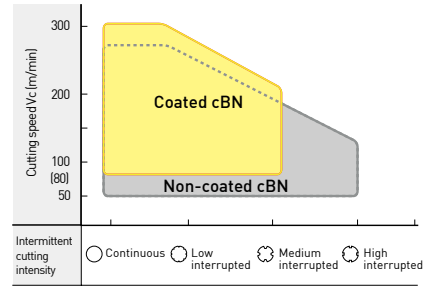
cBN Heat treated steel



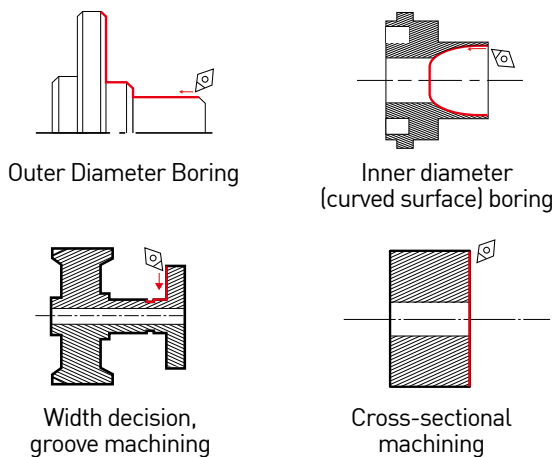
Applicable area

- **Coated cBN** : Suitable for all heat-treated steel machining as it is excellent in high-speed high-efficiency machining
- **Non-coated cBN** : Suitable for machining of high-hardness heat-treated steel or parts to which cutting speed is limited

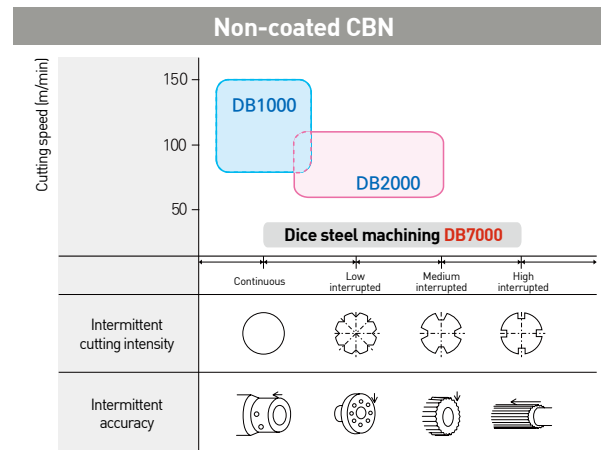
Series	Usable area
Coated cBN	<ul style="list-style-type: none"> • Ideal for heat-treated steel machining • Machining requiring high speed and high precision • Machining requiring high efficiency such as carburized layer removal
Uncoated cBN	<ul style="list-style-type: none"> • Small parts not requiring high cutting speed • Machining materials including much hard particles such as mold parts • Applicable even in case of an unstable machine setup



Recommended Machining Works



Dice steel





cBN Heat treated steel

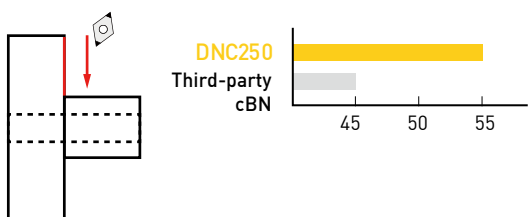


Example of machining of coated grades

Machining example

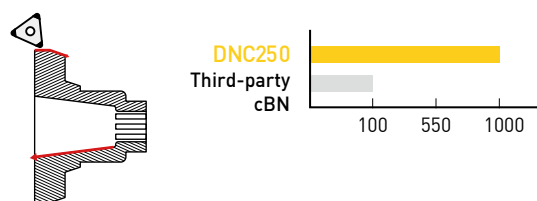
DNC250 TEST RESULT

Grade	DNC250	Third-party cBN
INSERTS	2NU-DNGA150408	
Parts name (workpiece)	H6 Swash plate (FCD55 Plate)	
Vc(m/min)		
f(mm/rev)	0.06	
ap(mm)	0.05 - 0.10	
Dry/wet cutting	Wet cutting	



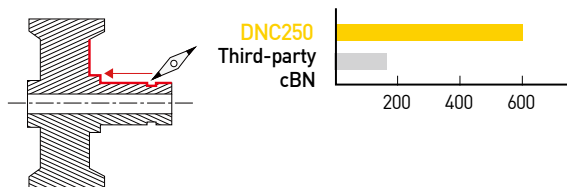
DNC250 TEST RESULT

Grade	DNC250	Third-party cBN
INSERTS	3NU-TNGA160408	
Parts name (workpiece)	Shaft UD Brake(SCR420HB)	
Vc(m/min)	160	
f(mm/rev)	0.08	
ap(mm)	0.425	
Dry/wet cutting	Wet cutting	



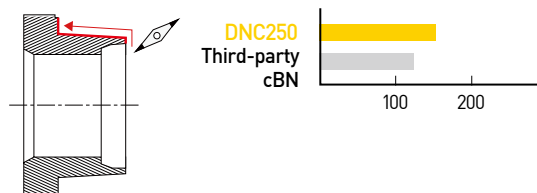
DNC250 TEST RESULT

Grade	DNC250	Third-party cBN
INSERTS	2NU-VCGW160408	
Parts name (workpiece)	Trans driver gear (SCM422)	
Vc(m/min)	90	
f(mm/rev)	0.15	
ap(mm)	0.15	
Dry/wet cutting	Wet cutting	



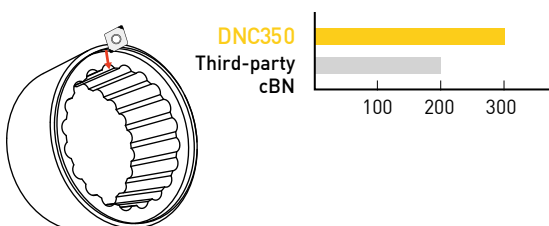
DNC250 TEST RESULT

Grade	DNC250	Third-party cBN
INSERTS	2NU-VNGA160408	
Parts name (workpiece)	CLUTCH BODY (SCr420 8903)	
Vc(m/min)	140	
f(mm/rev)	0.12	
ap(mm)	0.025/0.075	
Dry/wet cutting	Wet cutting	



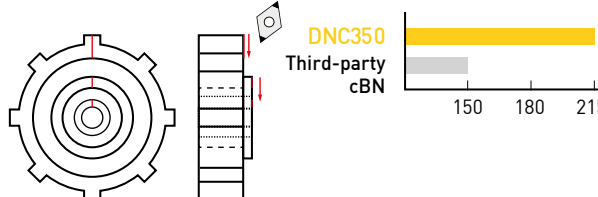
DNC350 TEST RESULT

Grade	DNC350	Third-party cBN
INSERTS	2NU-CNGA120408	
Parts name (workpiece)	Anulus Gear (SCR420)	
Vc(m/min)	200	
f(mm/rev)	0.05 - 0.08	
ap(mm)	0.4	
Dry/wet cutting	Wet cutting	



DNC350 TEST RESULT

Grade	DNC350	Third-party cBN
INSERTS	2NU-CNGA120404	
Parts name (workpiece)	Retainer (SAPH440-P)	
Vc(m/min)	150	
f(mm/rev)	0.20	
ap(mm)	0.10-0.20	
Dry/wet cutting	Wet cutting	



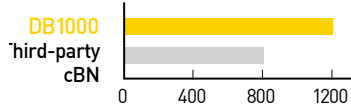
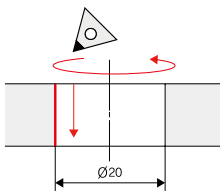
※The details may vary according to machining environments.



Machining example

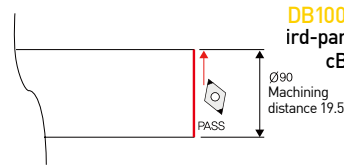
DB1000 TEST RESULT

Grade	DB1000	Third-party cBN
INSERTS	NU-TPGW110304	
Parts name (workpiece)	Inner diameter boring machining (SUJ2)	
Vc(m/min)	120	
f(mm/rev)	0.06	
ap(mm)	0.2	
Dry/wet cutting	Wet cutting	



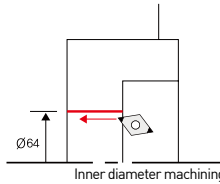
DB1000 TEST RESULT

Grade	DB1000	Third-party cBN
INSERTS	2NU-CNGA120408	
Parts name (workpiece)	Inner diameter boring machining (SUJ2)	
Vc(m/min)	282	
f(mm/rev)	0.1	
ap(mm)	0.1	
Dry/wet cutting	Wet cutting	



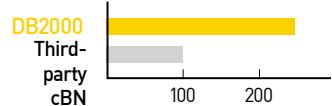
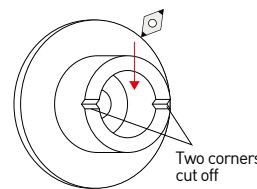
DB1000 TEST RESULT

Grade	DB1000	Third-party cBN
INSERTS	2NU-CNGA120412-W	
Parts name (workpiece)	Reactor	
Vc(m/min)	210	
f(mm/rev)	0.15	
ap(mm)	0.23	
Dry/wet cutting	Wet cutting	



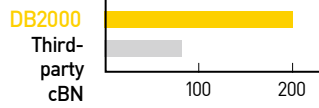
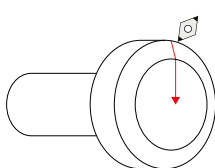
DB2000 TEST RESULT

Grade	DB2000	Third-party cBN
INSERTS	2NU-DNGA150408	
Parts name (workpiece)	Poly slide (SCM415H CVT)	
Vc(m/min)	150	
f(mm/rev)	0.1	
ap(mm)	0.2	
Dry/wet cutting	Wet cutting	



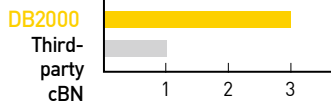
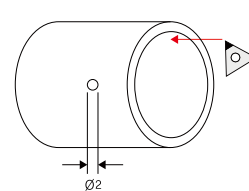
DB2000 TEST RESULT

Grade	DB2000	Third-party cBN
INSERTS	2NU-DNGA150408	
Parts name (workpiece)	Plunger (SKD11)	
Vc(m/min)	100	
f(mm/rev)	0.03 - 0.25	
ap(mm)	0.04	
Dry/wet cutting	Wet cutting	



DB2000 TEST RESULT

Grade	DB2000	Third-party cBN
INSERTS	NU-TPGW110308	
Parts name (workpiece)	Clutch parts (SCM415H)	
Vc(m/min)	135	
f(mm/rev)	0.08	
ap(mm)	0.15	
Dry/wet cutting	Wet cutting	



※The details may vary according to machining environments.



cBN Heat treated steel

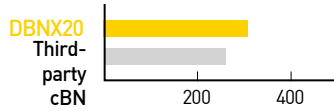
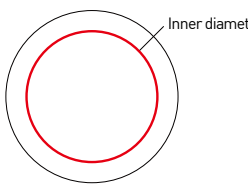


Uncoated grade machining example

Machining example

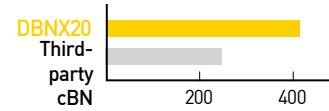
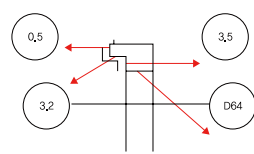
DBNX20 TEST RESULT

Grade	DBNX20	Third-party cBN
INSERTS	VBMW160412	
Parts name (workpiece)	BH-RR Outer wheel	
Vc(m/min)	130	
f(mm/rev)	0.1	
ap(mm)	0.2	
Dry/wet cutting	Wet cutting	



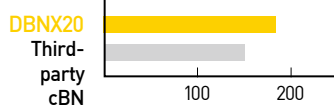
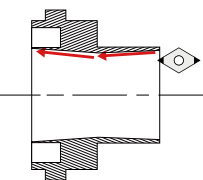
DBNX20 TEST RESULT

Grade	DBNX20	Third-party cBN
INSERTS	2NU-CNGA120408	
Parts name (workpiece)	Reactor	
Vc(m/min)	221-248	
f(mm/rev)	0.1	
ap(mm)	0.2	
Dry/wet cutting	Wet cutting	



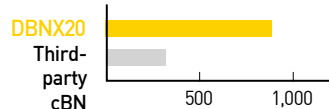
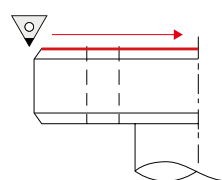
DBNX20 TEST RESULT

Grade	DBNX20	Third-party cBN
INSERTS	2NU-DNGA150612	
Parts name (workpiece)	Transmission bearing (STB2)	
Vc(m/min)	137	
f(mm/rev)	0.18-0.20	
ap(mm)	0.08-0.10	
Dry/wet cutting	Wet cutting	



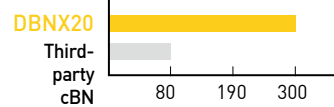
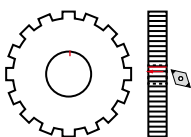
DBNX20 TEST RESULT

Grade	DBNX20	Third-party cBN
INSERTS	NU-TNMA160408	
Parts name (workpiece)	Flange (HrC62 SCM415)	
Vc(m/min)	150	
f(mm/rev)	0.1	
ap(mm)	0.12	
Dry/wet cutting	Wet cutting	



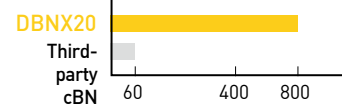
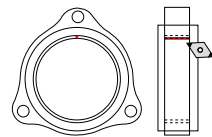
DBNX20 TEST RESULT

Grade	DBNX20	Third-party cBN
INSERTS	CNMA120408	
Parts name (workpiece)	Chain Sprocket (sintered alloy)	
Vc(m/min)	200	
f(mm/rev)	0.1	
ap(mm)	0.1	
Dry/wet cutting		



DBNX20 TEST RESULT

Grade	DBNX20	Third-party cBN
INSERTS	2NU-DNGA150412	
Parts name (workpiece)	Bearing outer wheel (S55 CR)	
Vc(m/min)	190	
f(mm/rev)	0.15	
ap(mm)	0.20	
Dry/wet cutting		



※The details may vary according to machining environments.



cBN Heat treated steel

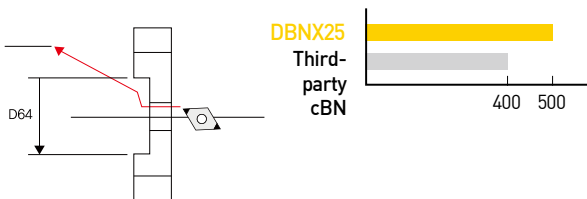


Uncoated grade machining example

Machining example

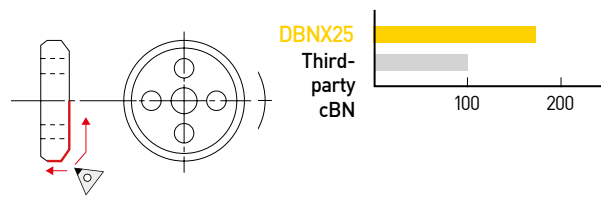
DBNX25 TEST RESULT

Grade	DBNX25	Third-party cBN
INSERTS	2NU-CNGA120412-W	
Parts name (workpiece)	Reactor	
Vc(m/min)	200-220	
f(mm/rev)	0.12-0.16	
ap(mm)	0.12-0.16	
Dry/wet cutting	Wet cutting	



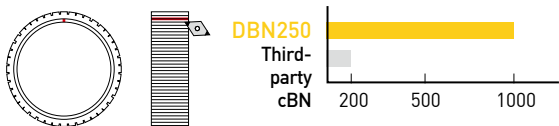
DBNX25 TEST RESULT

Grade	DBNX25	Third-party cBN
INSERTS	NU-TNMA160408	
Parts name (workpiece)	Gear (HrC60 SCM420)	
Vc(m/min)	150	
f(mm/rev)	0.12	
ap(mm)	0.2	
Dry/wet cutting	Wet cutting	



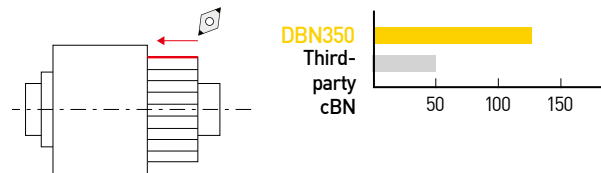
DBN250 TEST RESULT

Grade	DBN250	Third-party cBN
INSERTS	3NU-TPGB110308	
Parts name (workpiece)	Sprocket Crank Shaft (SCM415)	
Vc(m/min)	120-180	
f(mm/rev)	0.18	
ap(mm)	0.12	
Dry/wet cutting	Wet cutting	



DBN350 TEST RESULT

Grade	DBN350	Third-party cBN
INSERTS	NU-CNMA120412	
Parts name (workpiece)	Gear shaft (SCR420H)	
Vc(m/min)	125	
f(mm/rev)	0.15	
ap(mm)	0.3	
Dry/wet cutting	Wet cutting	



※The details may vary according to machining environments.



cBN Cast iron

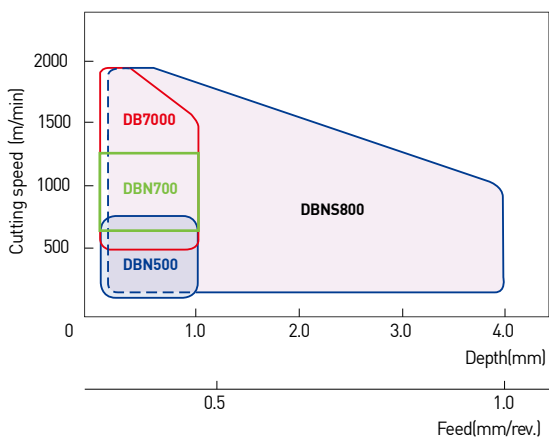


Features and cutting conditions of cBN grade

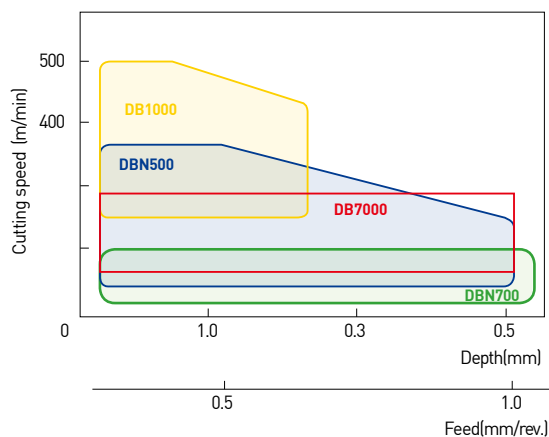
Applications	Workpiece	Grade	Cutting conditions				Feed f(mm/rev)	Cutting depth ap(mm)		
			Cutting speed Vc(m/min)							
			100	500	1000	1500			2000	
Turning	Gray cast iron	DBNS800	200	[Bar chart: 200 to 2000]			2000	0.1 ~ 1.0	≤4.0	
		DBN500	200	[Bar chart: 200 to 700]			700	0.1 ~ 0.5	≤1.0	
		DB7000	500	[Bar chart: 500 to 2000]			2000	0.1 ~ 0.5	≤1.0	
	Alloy cast iron	DBNS800	200	[Bar chart: 200 to 1000]			1000	0.1 ~ 0.8	≤2.0	
		DBN500	100	[Bar chart: 100 to 350]			350	0.1 ~ 0.4	≤0.5	
		DB1000	250	[Bar chart: 250 to 500]			500	0.1 ~ 0.2	≤0.2	
Ductile cast iron	DB7000	80	[Bar chart: 80 to 200]			200	0.1 ~ 0.4	≤0.5		
	Milling	Gray cast iron	DBN700	800	[Bar chart: 800 to 2000]			2000	0.1 ~ 0.5	≤0.5
			DBNS800	800	[Bar chart: 800 to 2000]			2000	0.1 ~ 1.0	≤4.0

Applicable area

Gray cast iron



Ductile cast iron





cBN Cast iron



cBN grade features

Grade		Insert color	Applications	Features
Classification	Coated or uncoated			
	Uncoated	DBN700	High-speed cutting of FC / cutting of milling of FC, cutting of iron metal heat-treated parts cutting of high-hardness roll / cutting of heat-resistant ally	Grades whose material strength and thermal conductivity are improved by greatly increasing cBN content and optimizing sintered tissues
		DBN500	FC, FCD cutting, high-hardness VSR cutting, high-hardness roll grinding cutting	For cast iron cutting, cBN sintered body formation is optimized and wear resistance and damage resistance are excellent
		DB7000	Foundry machining	For cast-iron difficult-to-cut materials machining, wear resistance and damage resistance are excellent
		DBNS800	Large cutting depth machining, high-precision grinding machining	The solid structure capable to be used cutting knife of entire insert, which responds brazing type machining and high-speed grinding unlike conventional brazing type

Machining example

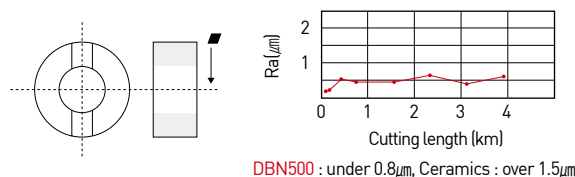
DBN500 TEST RESULT

Grade	DBN500	Third-party cBN
INSERTS	SPGN090308	
Parts name (workpiece)	Crank bore (FC250 = FCD450 Inner boring)	
Vc(m/min)	150	
f(mm/rev)	0.15	
ap(mm)	0.5	
Dry/wet cutting	Wet cutting	



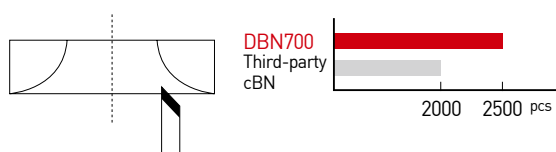
DBN500 TEST RESULT

Grade	DBN500	Third-party cBN
INSERTS	CNMA120412	
Parts name (workpiece)	Compressor Comp (FC250 facing, Interrupted)	
Vc(m/min)	400	
f(mm/rev)	0.07	
ap(mm)	0.15	
Dry/wet cutting	Wet cutting	



DBN700 TEST RESULT

Grade	DBN700	Third-party cBN
INSERTS	Special Bite	
Parts name (workpiece)	VSR intake (Hv250-330 Plunge Cutting)	
Vc(m/min)	95	
f(mm/rev)	0.08	
ap(mm)	0.2	
Dry/wet cutting	Dry cutting	



DBN700 TEST RESULT

Grade	DBN700	Third-party cBN
INSERTS	SPGN090308 / TNGA150408	
Parts name (workpiece)	Fly wheel (FC300 facing)	
Vc(m/min)	600	
f(mm/rev)	0.15	
ap(mm)	0.2	
Dry/wet cutting	Wet cutting	



※The details may vary according to machining environments.



cBN Sintered parts

Sintering Parts



Features and cutting conditions of cBN grade

* First recommended

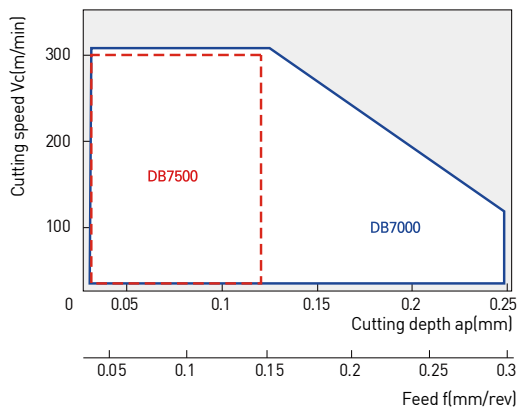
Classification	Grade		Insert color	Applications	Features
	Coated or uncoated	Name			
Sintering Parts	Uncoated	DB7000		High density heat treated parts	Features excellent wear resistance and damage resistance in sintered alloy machining to stably implement a long service life
		DB7500*		High density heat treated parts	Suitable for sintered alloy grinding machining by maintaining the best cutting taste

Workpiece	Grade	Cutting conditions					Feed f(mm/rev)	Cutting depth ap(mm)
		Cutting speed Vc(m/min)						
		100	150	200	250	300		
General sintered alloy	DB7000	80	[Bar from 100 to 300]			300	0.1 ~ 0.3	≤0.25
	DB7500*	80	[Bar from 100 to 300]			300	0.1 ~ 0.15	≤0.25

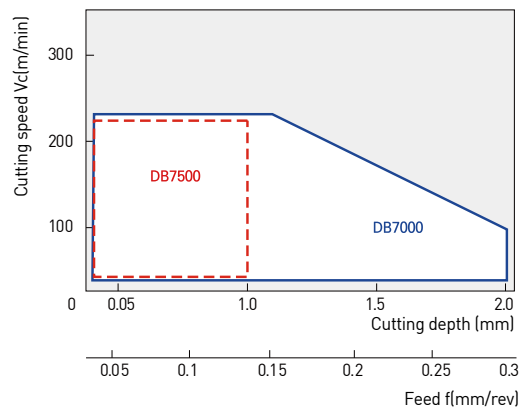
Workpiece	Grade	Cutting conditions					Feed f(mm/rev)	Cutting depth ap(mm)
		Cutting speed Vc(m/min)						
		100	150	200	250	300		
High-density heat-treated sintered alloy	DB7000	80	[Bar from 100 to 200]			200	0.1 ~ 0.3	≤0.2
	DB7500*	80	[Bar from 100 to 200]			200	0.1 ~ 0.15	≤0.2

Applicable area

General sintered alloy



High-density heat-treated sintered alloy



※The details may vary according to machining environments.

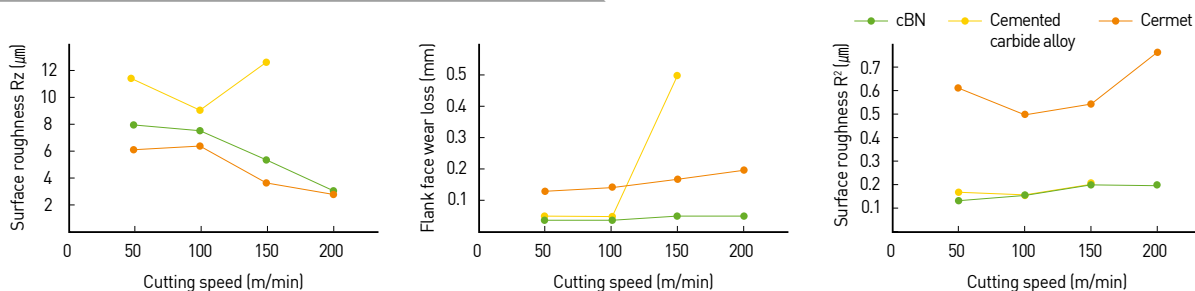


cBN Sintered parts

Sintering Parts

cBN cutting performance

Comparison of cutting performance by tool materials



- **Workpiece** : Equivalent to SMF4040
- **Details of machining** : High interrupted cross-sectional machining with a groove, hole Ø80-Ø100 (after 40 pass machining)
- **Tool model no.** : TNGA160404 / DB7000
- **Cutting conditions** : f=0.1mm/rev.ap=0.1mm, wet cutting

General sintered alloy up to Vc=100m/min can be machined even in the case of cemented carbide alloy or cermet. But after about Vc=120m/min it is rapidly worn so surface roughness is weakened and burr is expanded. On the contrary, cBN ensures reliable machining as it is excellent in surface roughness in high-speed areas, wear resistance, and burr inhibition.

Valve seat ring (VSR)

VSR is divided into VSR for Intake (IN) and VSR for Exhaust (EX). Generally, VSR for EX is of high hardness.

Recommended grade

Cutting speed	Gasoline engine VSR material	Diesel engine VSR material
Flange cutting	DB7000 DBN350	DB7000 DBN350
Traverse cutting	DB7000 DBN500	DB7000 DBN500
Workpiece hardness (HV)	Low ◀ HV300 ▶ High	Low ◀ HV300 ▶ High

Recommendation conditions

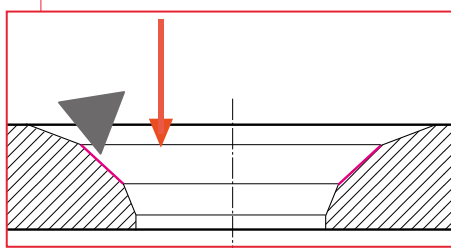
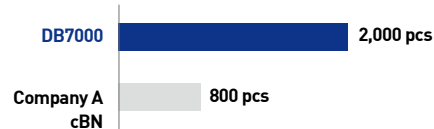
Cutting speed Vc(m/min)	Feed f(mm/rev)	Cutting depth ap(mm)
50~100	0.03~0.2	0.05~0.5

Cutting example



※Cylinder head shape

The tool service life was increased more than two fold versus conventional one when machining with DB7000 whose damage resistance is excellent.



Recommendation conditions

- **Workpiece** : Sintered alloy (150-250HV)
- **Details of machining** : VSR(IN) 45-face grinding machining
- **Tool model no.** : TBGN060104 (DB7000)
- **Cutting conditions** : Vc=100m/min, f=0.08mm/rev, wet cutting

※The details may vary according to machining environments.



DNC100

Coated cBN



Coating Heat treated steel Max Depth 0.3mm Continuous

Features

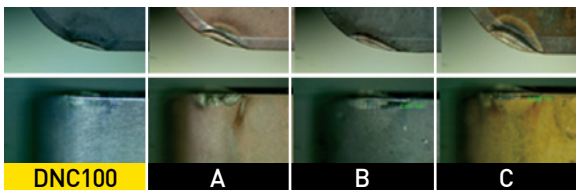
- Grade first recommended of high-speed continuous machining
- High heat resistance with high oxidation temperature
- Thin film applied with high hardness and high resistance to oxidation and chipping

Grade	Texture	Binder	cBN content (%)	Grain size (μm)	Hardness HV (Gpa)
DNC100		TiN	50 - 55	2	31 - 34

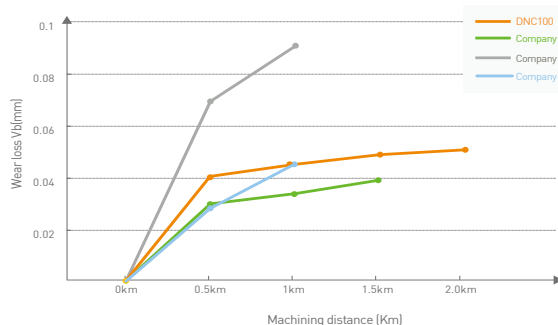


Performance comparison test

Wear resistance comparison test in high-speed machining



Wear loss



Cutting conditions

Insert model no.	2NU-CNGA120408
Test holder	DCLNL2525-M12
Workpiece	SCM415 [58-62HrC]
Machining speed	300m/min
Feed	0.1mm/rev
Depth of cutting	0.1mm
Dry/wet cutting	Dry machining

Applicable area

Cutting speed (m/min)	DNC100			
	Continuous	Low interrupted	Medium interrupted	Heavy interrupted
Intermittent cutting intensity				
Intermittent accuracy				

Recommended Cutting Conditions

Cutting Speed VC (m/min)	180	300
Feed f(mm/rev)	0.03	0.3
Single cutting depth D.O.C ap (mm)	0.03	0.3

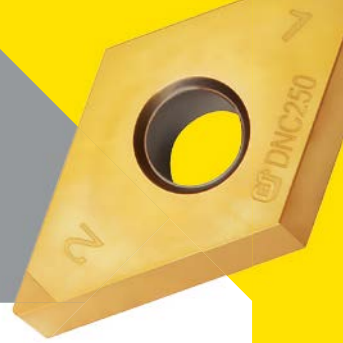
- Improved wear resistance and oxidation resistance with high-hardness thin film adopted
- Significantly improved resistance to chipping, fracture, and wear

※The details may vary according to machining environments.



DNC250

Coated cBN

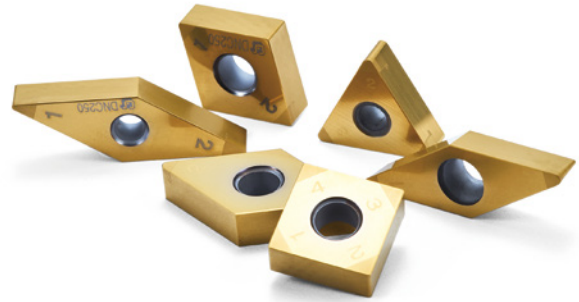


Coating Heat treated steel Max Depth 0.3mm Continuous Low interrupted

Features

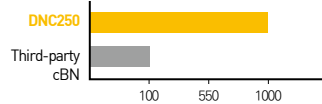
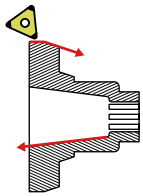
- Grade first recommended for continuous machining
- General-purpose cBN that enables machining ranging from Continuous cutting to Low interrupted cutting by PVD coating application
- Wear resistance improved

Grade	Texture	Binder	cBN content (%)	Grain size (μm)	Hardness HV (Gpa)
DNC250		TiC	65 - 70	4	32 - 34

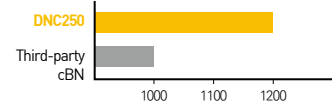
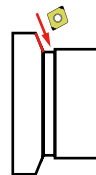


Machining example

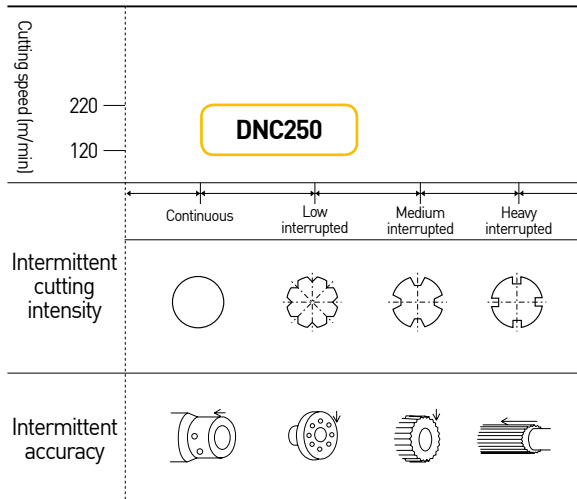
Grade	DNC250	Third-party cBN
INSERTS	3NU-TNGA160408	
Parts name (workpiece)	Shaft UD Brake(SCR420HB)	
Vc(m/min)	160	
f(mm/rev)	0.08	
ap(mm)	0.425	
Dry/wet cutting	Wet cutting	



Grade	DNC250	Third-party cBN
INSERTS	2NU-CNGA120408	
Parts name (workpiece)	Hardness : Hrc40~50 (SCM92 0HVS I)	
Vc(m/min)	280	
f(mm/rev)	0.08-0.15	
ap(mm)	0.2	
Dry/wet cutting	Wet cutting	

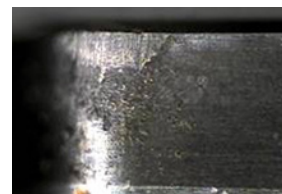


Applicable area

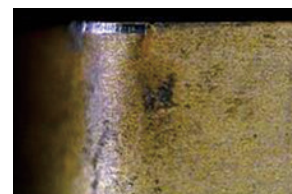


Recommended Cutting Conditions

Cutting Speed Vc (m/min)	120	220
Feed f(mm/rev)	0.05	0.3
Single cutting depth D.O.C ap (mm)	0.05	0.3



Non-coating



Coating

※The details may vary according to machining environments.



DNC300

NEW

Coated cBN



Coating Heat treated steel Max Depth Low interrupted Medium interrupted

Features

- Grade first recommended for machining ranging from Low interrupted to Medium interrupted
- Improved resistance to chipping and wear versus rival products
- Minimized coating peeling due to its stable coating

Grade	Texture	Binder	cBN content (%)	Grain size (μm)	Hardness HV (Gpa)
DNC300		TiN	65 - 70	4	29 - 31

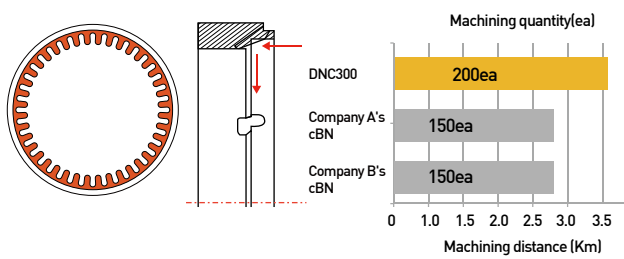


Performance comparison

[Interrupted] V90 F0.1 D0.1 / SCR420H(HrC58~62) / DRy (4PATH=0.21KM)

[Outer dia. interrupted] V120 F0.1 D0.1 / 9PATH

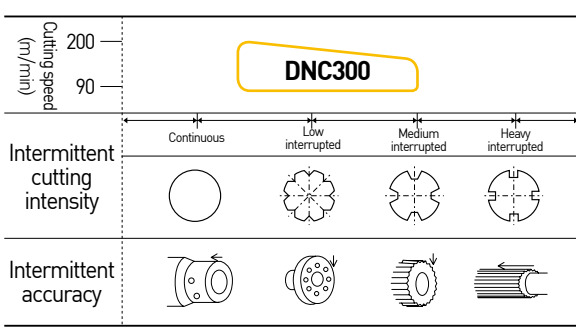
Machining example



Superior performance due to less VB wear loss of DNC 300

Grade	DNC300	Company A cBN	Company B cBN
INSERTS	CNGA120408		
Parts name (workpiece)	Heat-treated steel (HrC57.8)		
Vc(m/min)	160		
f(mm/rev)	0.08		
ap(mm)	0.2~0.3		
Dry/wet cutting	Wet cutting		

Applicable area



Recommended Cutting Conditions

Cutting Speed VC (m/min)	90	200
Feed f(mm/rev)	0.05	0.3
Single cutting depth D.O.C ap (mm)	0.05	0.25

- Wear resistance and oxidation resistance are improved with high-hardness thin film adopted
- Significantly improved resistance to chipping, fracture, and wear

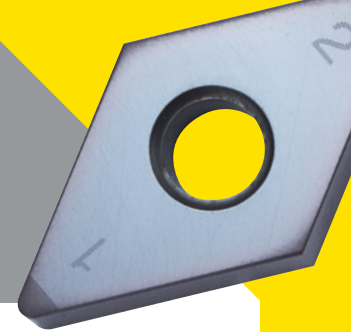
※The details may vary according to machining environments.





DNC350

Coated cBN

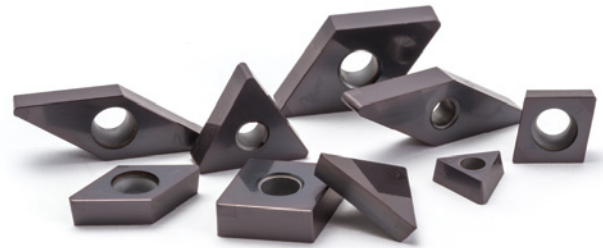


Coating	Heat treated steel	Max Depth 0.3mm	Low interrupted	Heavy interrupted

Features

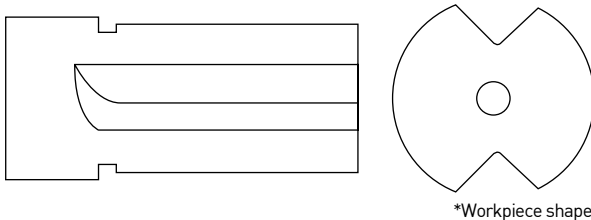
- Grade first recommended for interrupted cutting
- Maintains functionality and precision for a long time due to its advanced coating technology
- Economical due to its longer service life

Grade	Texture	Binder	cBN content (%)	Grain size (μm)	Hardness HV (Gpa)
DNC350		TiN	60 - 65	1	33 - 35

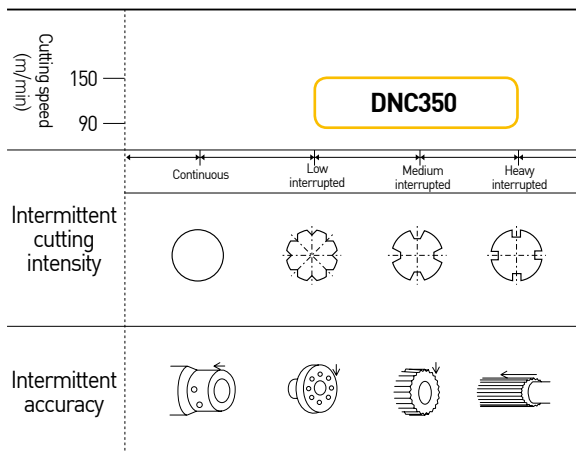


Machining example

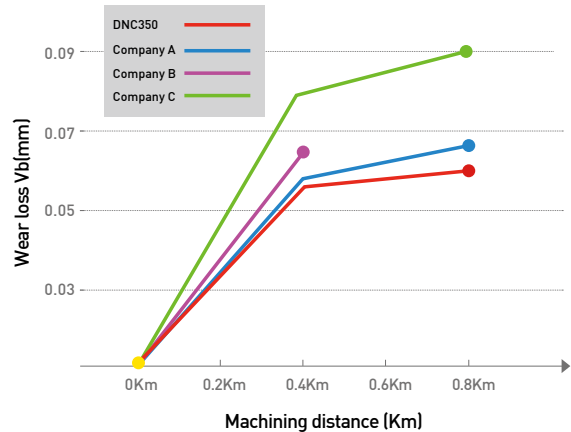
Grade	DNC350	Third-party cBN
INSERTS	2NU-CNGA120408	
Parts name (workpiece)	SCM415(HrC58~60)	
Vc(m/min)	120	
f(mm/rev)	0.1	
ap(mm)	0.1	
Dry/wet cutting	Dry cutting	



Applicable area



Wear loss



Recommended Cutting Conditions

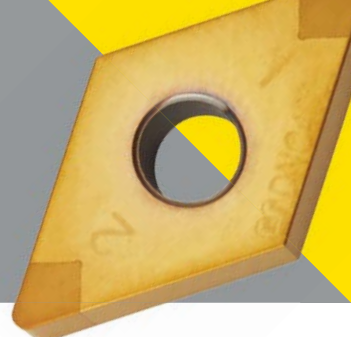
Cutting Speed VC (m/min)	90	150
Feed f(mm/rev)	0.05	0.3
Single cutting depth D.O.C ap (mm)	0.05	0.25

※The details may vary according to machining environments.



DNC400

Solid type coated cBN

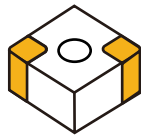
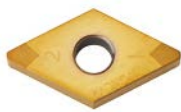


Coating	Heat treated steel	Max Depth 0.3mm	Continuous	Medium interrupted

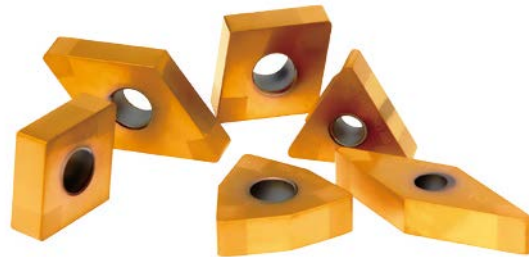
Solid type features

- Improves productivity through high-speed and high cutting depth machining
- Ideal for carburized layer removal and welded part machining
- Features excellent performance in case of cutting depth change

Solid type shape



e.g.) 4NS-CNGA120408

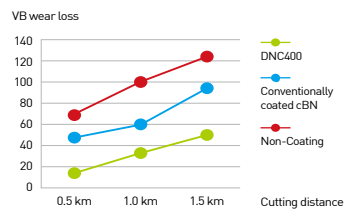


Grade	Texture	Binder	cBN content (%)	Grain size (μm)	Hardness HV (Gpa)
DNC400		TiN	65	3	-

Performance comparison

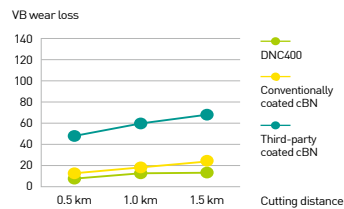
DNC400	Conventionally coated cBN	Non-Coating	Continuous machining

DNC400	Conventionally coated cBN	Third-party coated cBN	Interrupted machining



Machining conditions (Dry machining)

SUJ2 (Hardness Hrc 58-62)
Cutting Speed 150 m/min
Feed Rate 0.10 mm/rev
D.O.C 0.1 mm
Designation CNGA120408



Machining conditions (Dry machining)

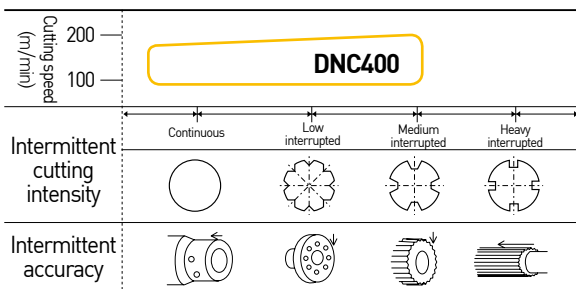
SUJ2 (Hardness Hrc 58-62)
Cutting Speed 150 m/min
Feed Rate 0.10 mm/rev
D.O.C 0.3 mm
Designation CNGA120408

Machining example

Grade	DNC400
INSERTS	CNGA120408
Parts name [workpiece]	GEAR SUN RR Cross section
Vc(m/min)	126
f(mm/rev)	0.15
ap(mm)	1
Dry/wet cutting	Wet cutting

Grade	DNC400
INSERTS	CNGA120408
Parts name [workpiece]	Cross-sectional machining (SCM920 HVSI)
Vc(m/min)	150
f(mm/rev)	0.1
ap(mm)	0.2 - 0.3
Dry/wet cutting	Dry cutting

Applicable area



Recommended Cutting Conditions

Cutting Speed VC (m/min)	80 - 200
Feed f(mm/rev)	0.05 - 0.3
Single cutting depth D.O.C ap (mm)	0.05 - 0.5

※The details may vary according to machining environments.



RA,GA Chip Breaker

cBN Chip Breaker

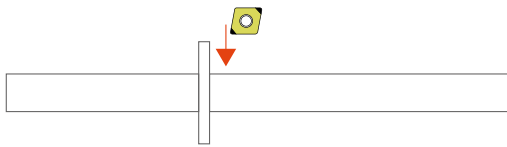


Coating Chip Breaker Max Depth

Features

- Prevents drag of chip into the workpiece during machining
- Ideal for unmanned automatic operations of the cutting process
- The RA chip breaker is for rough boring process.
- GA chip breaker is for finishing boring process.

Example of use



Non-breaker

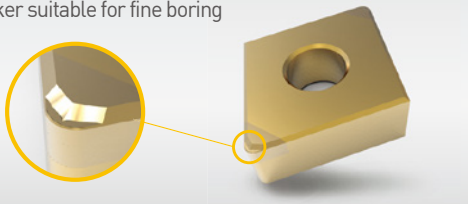


GA chip breaker

Chip Breaker

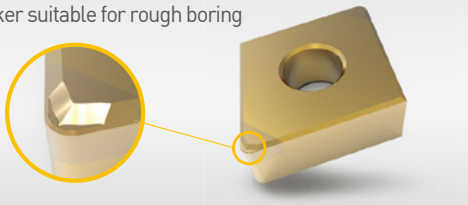
GA type

Chip breaker suitable for fine boring

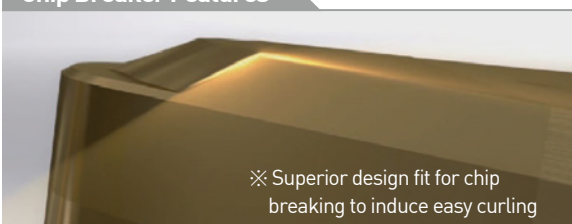


RA type

Chip breaker suitable for rough boring

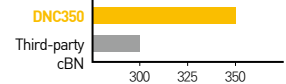


Chip Breaker Features



Applicable area

Grade	DNC350(GA)	Third-party cBN
INSERTS	2NU-CNGM120412-GA	
Parts name (workpiece)	Input Shaft (SCM920 HVS1)	
Vc(m/min)	145	
f(mm/rev)	0.1	
ap(mm)	0.4 ~ 0.5	
Dry/wet cutting	Wet cutting (excellent chip breaking versus rival products)	



Chip breaker comparison

GA Chip Breaker



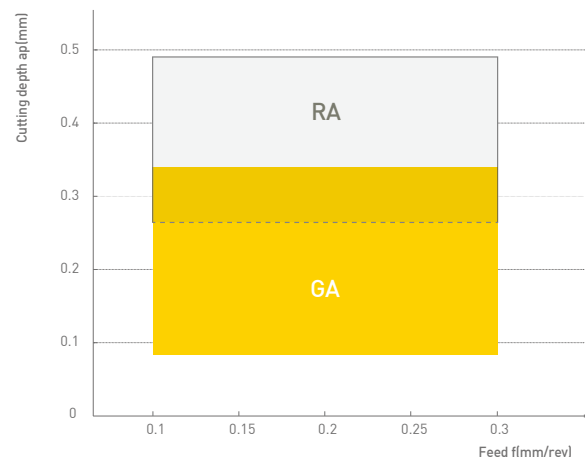
V=150m/min
f=0.15 mm/rev
ap=0.15mm

RA Chip Breaker



V=150m/min
f=0.15 mm/rev
ap=0.3mm

Applicable area



※The details may vary according to machining environments.

Chuck

Arbor / Modular

Boring tool

Angular head

cBN/PCD

Smart factory

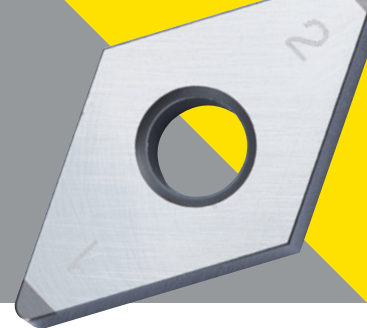
TAUMAX

OTHER



DB1000

Uncoated cBN



Non **H** **0.3mm** **Continuous**
 Non-Coating Heat treated steel Max Depth Continuous

Features

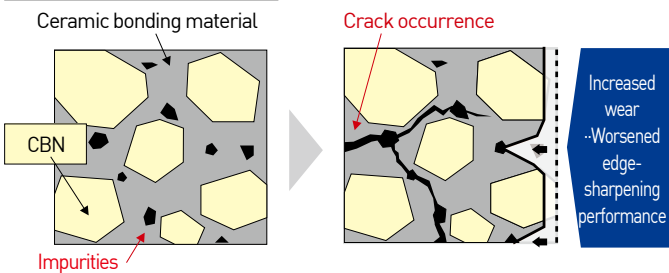
- Grade for high-speed machining with the best wear resistance among non-coated cBNs
- Features an excellent tool service life in the continuous cutting ~ Low interrupted cutting
- Focuses on wear resistance and improves fracture resistance
- Improves heat resistance and strength by high-purity TiCN ceramic bonding materials

Grade	Texture	Binder	cBN content (%)	Grain size (μm)	Hardness HV (Gpa)
DB1000		TiCN	40 - 45	1	27 - 31



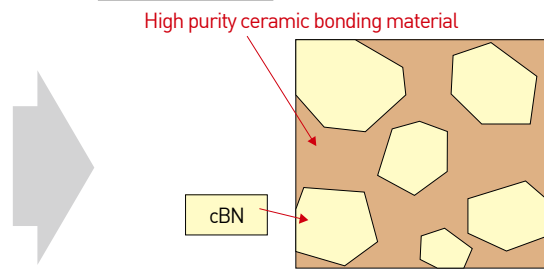
Newly developed high-purity ceramic bonding material

Conventional grade



Impurities included in conventional grade ceramic bonding materials decreased the strength and heat resistance of sintered parts, becoming the cause of crack (fracture) and wear.

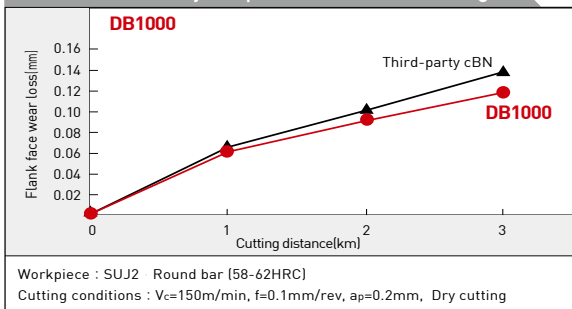
DB1000



DB1000 enhanced heat resistance and strong tenacity by reducing impurities to the very limit using the newly developed "high-purity ceramic bonding material".

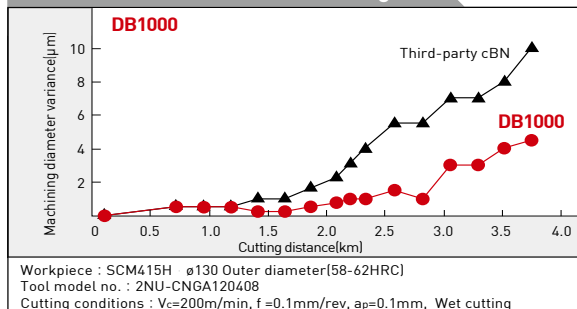
Cutting performance

Dimension accuracy comparison (continuous cutting)

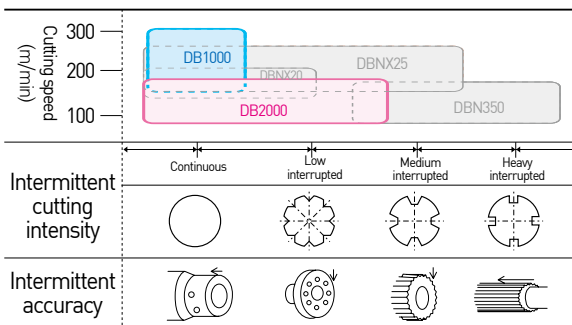


Machining precision

Wear resistance (continuous cutting)



Applicable area



Recommended Cutting Conditions

Cutting Speed VC (m/min)	130	250
Feed f (mm/rev)	0.03	0.15
Single cutting depth D.O.C ap (mm)	0.03	0.2

※ Cutting oil: Continuous cutting dry/wet, Interrupted cutting dry

※The details may vary according to machining environments.



DB2000

Uncoated cBN



Non H 0.3mm Continuous Medium interrupted
 Non-Coating Heat treated steel Max Depth Continuous Medium interrupted

Features

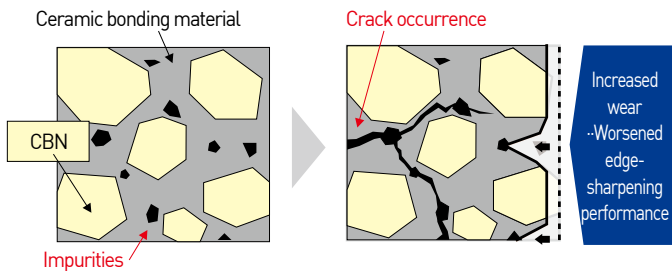
- General-purpose grade that responds to overall heat-treated steel
 - Realizes a stable tool service life ranging from continuous cutting to Low / Medium interrupted cutting
- Highly compatible with fracture resistance and wear resistance
 - Both properties greatly improved by the use of the high-purity ceramic bonding material
- Achieves a stable surface roughness based on edge-sharpening performance



Grade	Texture	Binder	cBN content (%)	Grain size (μm)	Hardness HV (Gpa)
DB2000		TiN	50 - 55	2	31 - 34

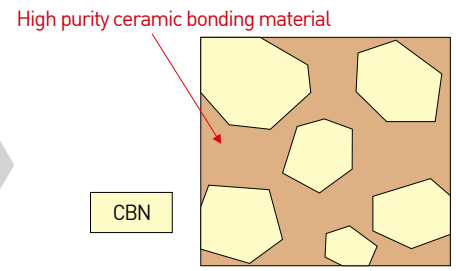
Newly developed high-purity ceramic bonding material

Conventional grade



Impurities included in conventional grade ceramic bonding materials decreased the strength and heat resistance of sintered parts, becoming the cause of cracks (fracture) and wear.

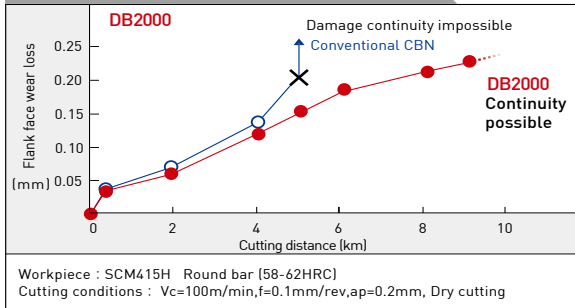
DB2000



DB2000 realizes enhanced heat resistance and strong tenacity by reducing impurities to the very limit using the newly developed "high-purity ceramic bonding material."

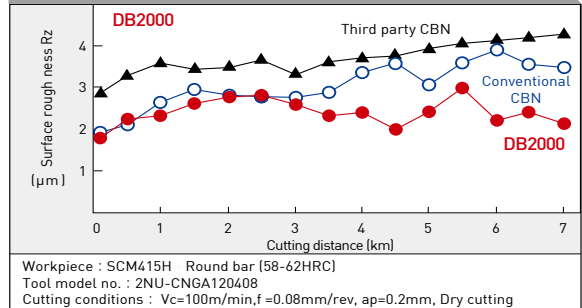
Cutting performance

Wear resistance (continuous cutting)

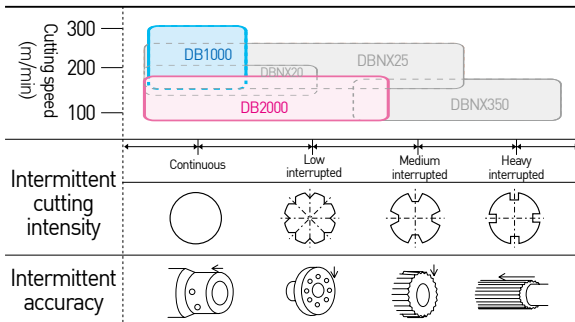


Machining precision

Surface roughness comparison (continuous cutting)



Applicable area



Recommended Cutting Conditions

Cutting Speed Vc (m/min)	80	200
Feed f (mm/rev)	0.03	0.2
Single cutting depth D.O.C ap (mm)	0.03	0.3

※ Cutting oil: Continuous cutting dry/wet, Interrupted cutting dry

※The details may vary according to machining environments.



DB7000

Uncoated cBN



Non K 0.5mm Sintered parts Continuous Low interrupted
 Non-Coating Cast iron Max Depth Sintered parts Continuous Low interrupted

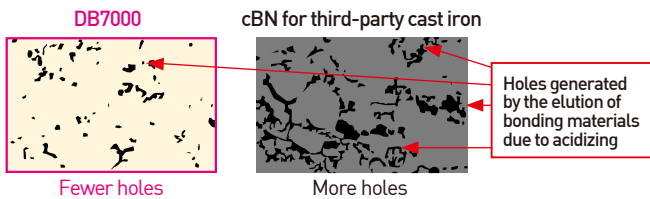
Features

- Ideal for high-speed grinding machining of cast iron
- Suppresses heat crack and realizes excellent damage resistance by high-speed machining of gray cast iron
- Realizes highly efficient sintered alloy machining
- Provides a stably longer service life in case of machining of sintered alloys with diverse shape hardness by meeting the requirements for cutting edge treated products of high standard+2 types
- Responds to various difficult-to-cut materials
- Features high performance for difficult-to-cut materials such as rolls, high-speed tools, and heat resistant alloys, etc.



Grade	Texture	Binder	cBN content (%)	Grain size (μm)	Hardness HV [Gpa]
DB7000		CO Compound	90 - 95	2	41 - 44

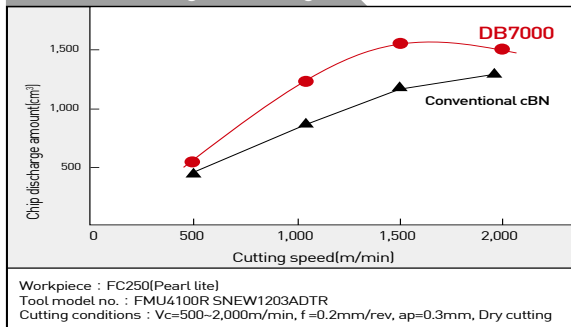
Tissue that acidized cBN sintered parts



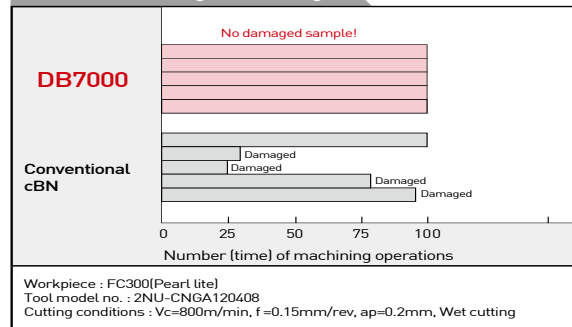
Provides an excellent damage resistance and an enhanced inter-cBN particle coherence by sintering intermediate particle cBNs in high density to realize the best content. Ensures a long service life and stable machining in high-speed grinding of hard-to-cut materials of cast iron sintered alloys.

Cutting performance

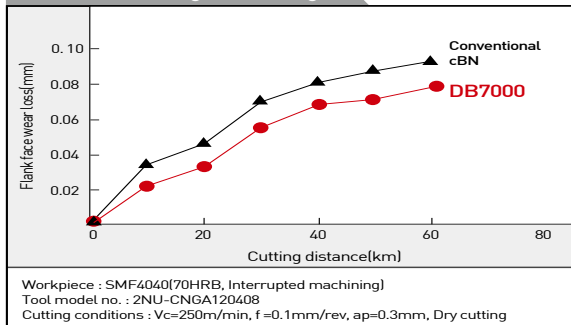
Cast iron milling machining



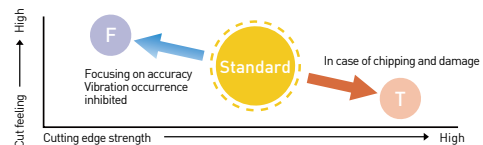
Cast iron turning machining



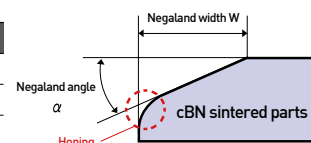
Cast iron turning machining



Recommended cutting edge treatment



Item	TYPE	Honing	Negaland	Angle
Sharp	F TYPE	—	—	—
Standard	N/A	N/A	0.12	15°
Reinforced	T TYPE	N/A	0.12	25°



※The details may vary according to machining environments.



DB7500

Uncoated cBN

Non Sintered parts 0.5mm Continuous Low interrupted
 Non-Coating Sintered parts Max Depth Continuous Low interrupted

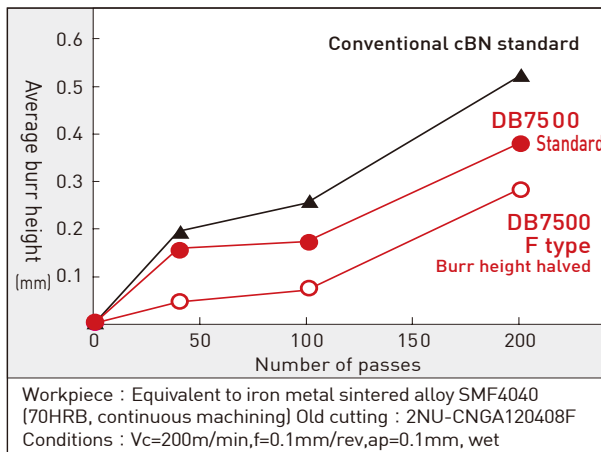
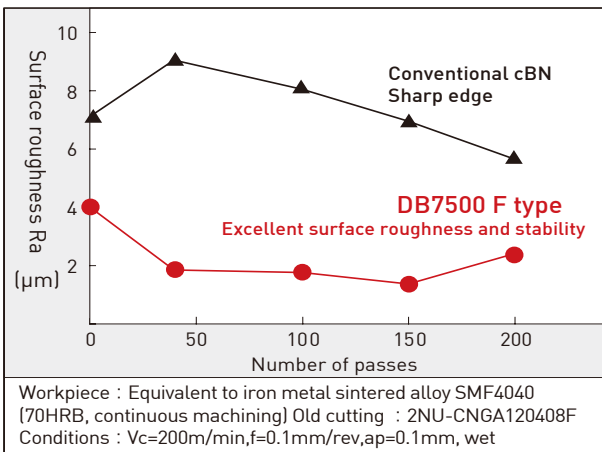
Features

- Ideal for grinding machining of sintered alloys
- Realizes excellent surface roughness and machined surface quality
- Various shapes of sintered parts by various cutting edge treatment
- Provides burr inhibition and machining precision improvement by F type that focuses on cutting taste designed for sintered alloy machining to meet grade requirements; Features stable resistance to chipping by cutting edge reinforced T type even in case of interrupted grinding machining



Grade	Texture	Binder	cBN content (%)	Grain size (μm)	Hardness HV (Gpa)
DB7500		CO Compound	90 - 95	1	41 - 44

Cutting performance



Feed-burr relationship

Workpiece : WT cross section
 Tool model no. : 3NU-TNGA160404
 Cutting conditions : Vc=200m/min, f=0.1mm/rev, ap=0.1mm, wet cutting

	F type	Standard type	T type
A			
B			

* If Feed is more than 0.1mm/rev, the T type is superior to the standard type in terms of cutting taste and burr can be inhibited.

Recommended cutting edge treatment

High Cut feeling / Cutting edge strength / Negaland angle
 F (Focusing on accuracy, Vibration occurrence inhibited)
 Standard (In case of chipping and damage)
 T (Honing)

Item	TYPE	Honing	Negaland	Angle
Sharp	FTYPE	—	—	—
Standard	N/A	NA	0.12	15°
Reinforced	T TYPE	NA	0.12	25°

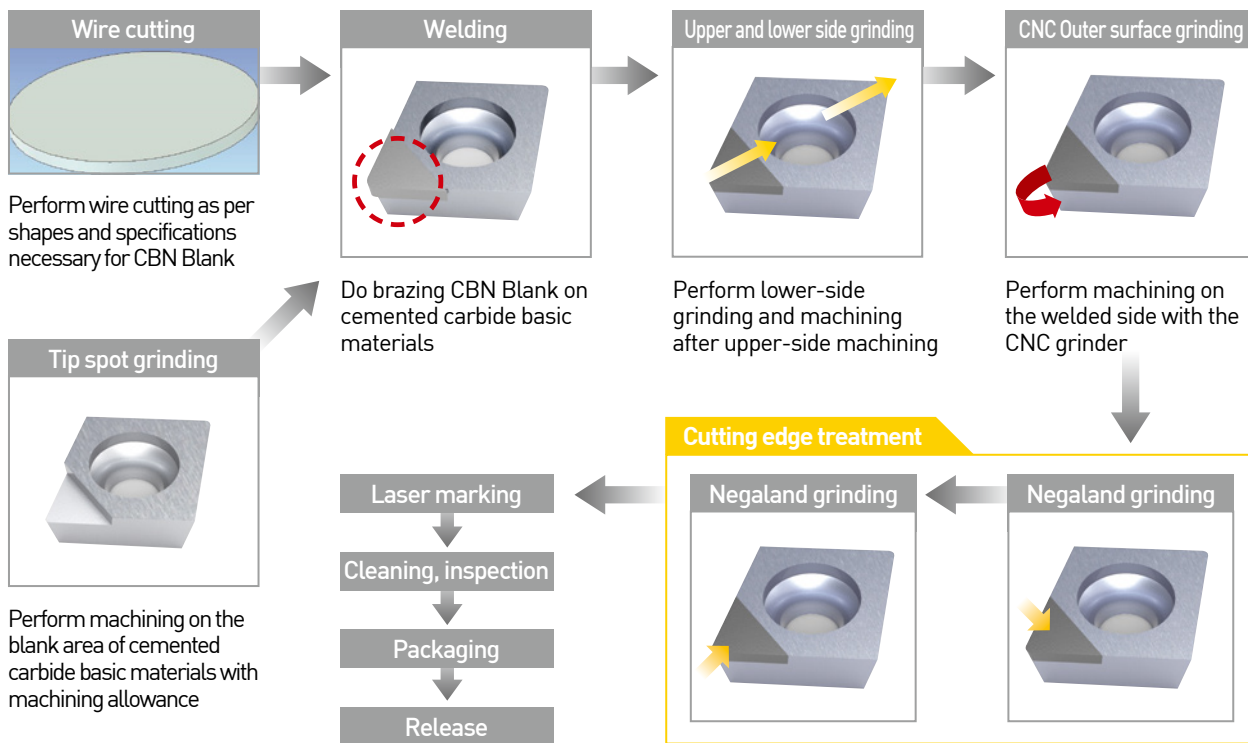
Negaland width W, Negaland angle α, Honing, cBN sintered parts

※The details may vary according to machining environments.

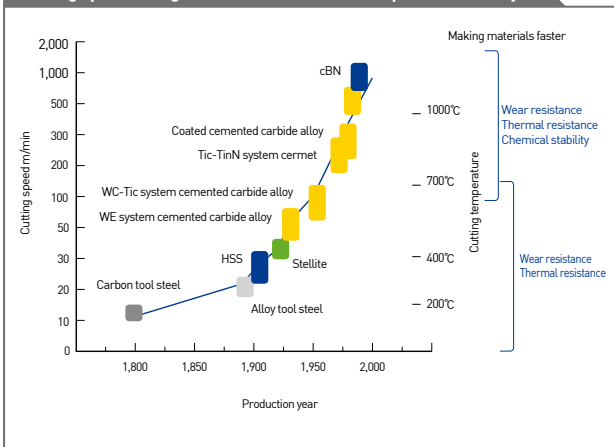


cBN Technical data

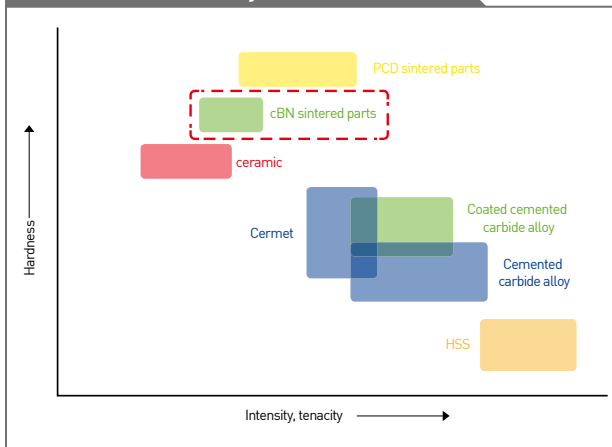
Manufacturing process of cBN



Cutting speed change and tool materials development in history



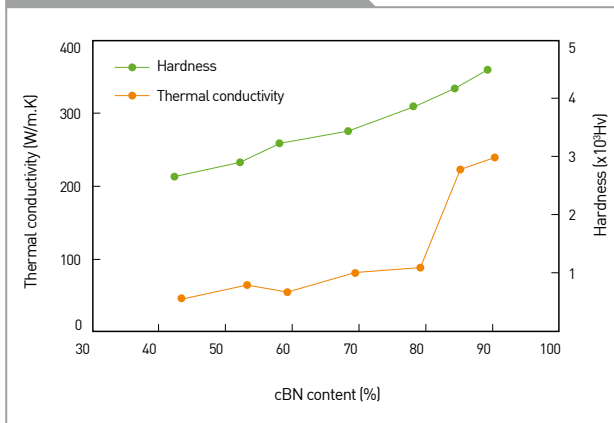
Hardness and intensity of tool materials



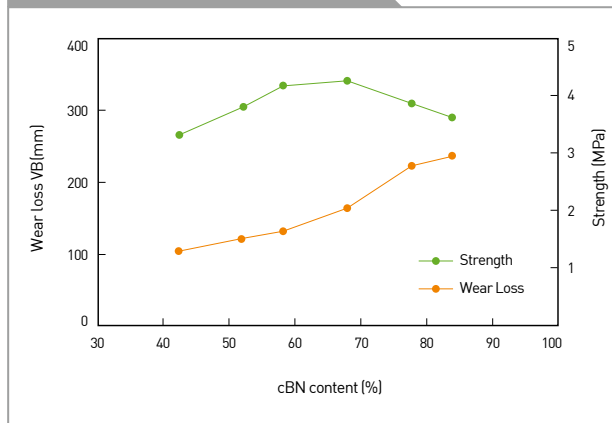


Main characteristics of cBN

Main characteristics I of cBN



Main characteristics II of cBN


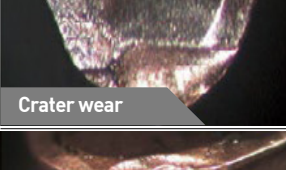
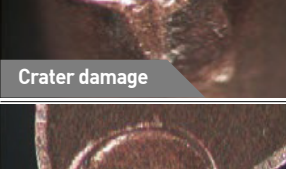
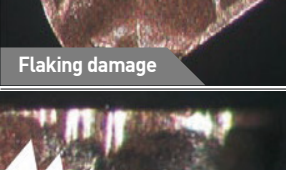
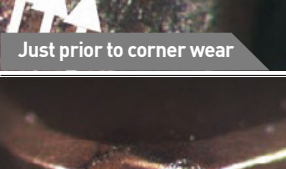
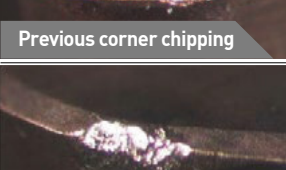
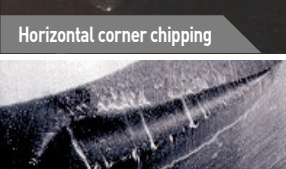
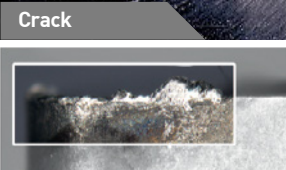


cBN machining workpieces and advantages of cutting machining

Workpiece	Representative parts	Advantages of cutting machining	Corresponding grade
Heat-treated steel	Transmission gear Driving shaft Shafts Valves Hydraulic parts, etc.	<ol style="list-style-type: none"> 1) Improved workpiece phenomenon accuracy 2) Responding to machining of composite parts and micro parts 3) Machining efficiency improved, grinding/polishing minimized 4) Investment equipment cost reduced 5) Environmental measures 	DNC100, DNC250 DNC300, DNC350 DNC400 DB1000, DB2000 DBN250, DBN350 DBNX20, DBNX25
Casting	Engine block Cases Brake disks, etc.	<ol style="list-style-type: none"> 1) Responding to high-speed machining 2) Responding to hard to cut material casting 3) Machining efficiency improved 	DBNS800, DBN500 DB7000
Sintered alloy	VVT(VTC) parts Various sprocket rotas, oil pump parts valve seats	<ol style="list-style-type: none"> 1) Improved workpiece phenomenon accuracy 2) Responding to heat treatment sintered parts and composite parts 3) Capacity utilization (longer tool service life) 4) High-speed, high-efficiency machining 	DBN500 DB7000, DB7500
Heat resistant alloy	Jet engine parts, etc.	<ol style="list-style-type: none"> 1) Machining efficiency improved 2) Workpiece machining surface roughness improved 	DBNX20



Causes of and measures for tool damage

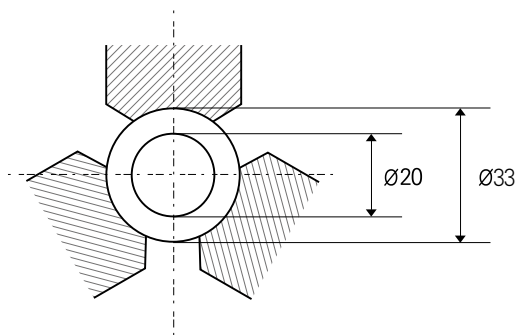
Insert damage type	Causes	Measures
 <p>Flank face wear</p>	<ul style="list-style-type: none"> • Insufficient of wear resistance of tool grade • Too high cutting speed 	<ul style="list-style-type: none"> • Select high wear resistance grade • Decrease cutting speed • Reduce to less than V_c 200m/min. (Measures to increase feed and decrease machining distance are effective.) • Enlarge clearance angle
 <p>Crater wear</p>	<ul style="list-style-type: none"> • Insufficient of crater wear resistance of tool grade • Too high cutting speed 	<ul style="list-style-type: none"> • Change to high-sufficiency machining grade • Decrease cutting speed and increase feed (Low speed, high feed) • Reduce to less than V_c 200m/min. (Measures to increase feed and decrease machining distance are effective.)
 <p>Crater damage</p>	<ul style="list-style-type: none"> • Insufficient tenacity of tool grade • High radial cutting force 	<ul style="list-style-type: none"> • Use high tenacity grade • Increase cutting edge strength (Enlarge Negaland angle and perform honing) • In case of sufficient tenacity of grade, increase cutting taste
 <p>Flaking damage</p>	<ul style="list-style-type: none"> • High stress of boundaries 	<ul style="list-style-type: none"> • Change to grade with strong resistance to corner wear • Increase cutting speed (more than 150m/min) • Change feed to a regular number of machining • Enlarge the Negaland angle and perform honing operation
 <p>Just prior to corner wear</p>	<ul style="list-style-type: none"> • Great impact on the front cutting edge and large number of times 	<ul style="list-style-type: none"> • Change to a grade with high resistance to damage • Increase feed (Impact of interruption reduced and chipping inhibited) • Enlarge the Negaland angle and perform honing operation
 <p>Horizontal corner chipping</p>	<ul style="list-style-type: none"> • Great impact on the horizontal cutting edge and large number of times 	<ul style="list-style-type: none"> • Change to a grade with high resistance to damage • Decrease feed • Enlarge horizontal cutting edge angle • Increase R size • Enlarge the Negaland angle and perform honing operation
 <p>Crack</p>	<ul style="list-style-type: none"> • Large heat impact 	<ul style="list-style-type: none"> • In case of wet cutting machining → dry cutting recommended • Change to high thermal conductivity grade • Decrease V_c, f, a_p to reduce machining load
 <p>Built up edge</p>	<ul style="list-style-type: none"> • Too low cutting speed • Strong affinity of the workpiece with the tool 	<ul style="list-style-type: none"> • Increase cutting speed • Select a shape whose slope angle is larger than the workpiece • Select a grade whose tenacity is better than the workpiece



Heat-treated steel high-precision machining points

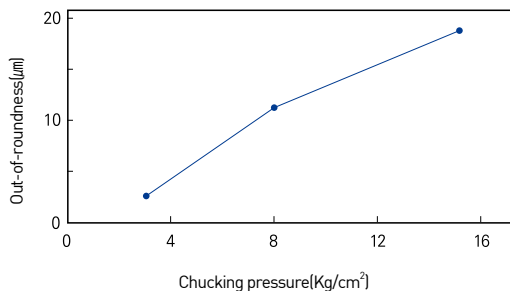
Perform chucking to apply to the workpiece as equally as possible		
	Good	Bad
Out of roundness		
Perform chucking in the vicinity of machining range		
	Good	Bad
Cylindricity		

Relationship of chucking pressure and out-of-roundness



Machining conditions

- Machine: General-purpose N/C lathe
- Workpiece: SUJ2 HRC60
- Chuck: 3Jaw
- Tool: DBN250
TPGW160404



Cutting condition

- V=150m/min
- f=0.04mm/rev.
- d=0.1mm wet cutting

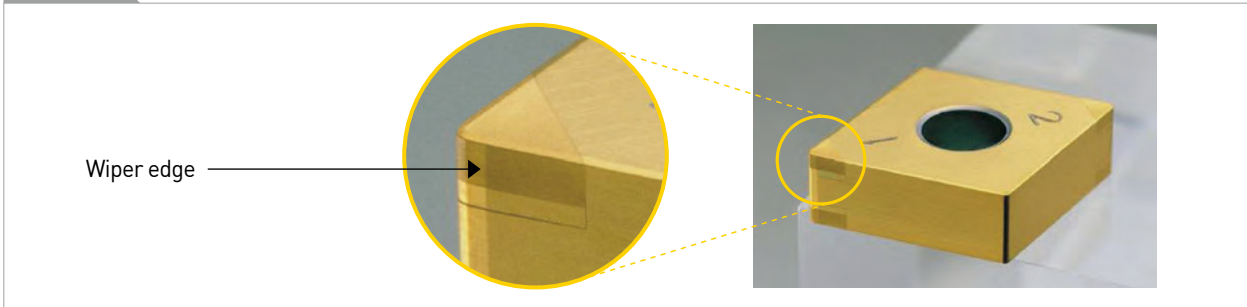
An appropriate chuck pressure is necessary for an excellent machining.



Characteristics of cBN cutting edge

cBN Wiper insert

Shape



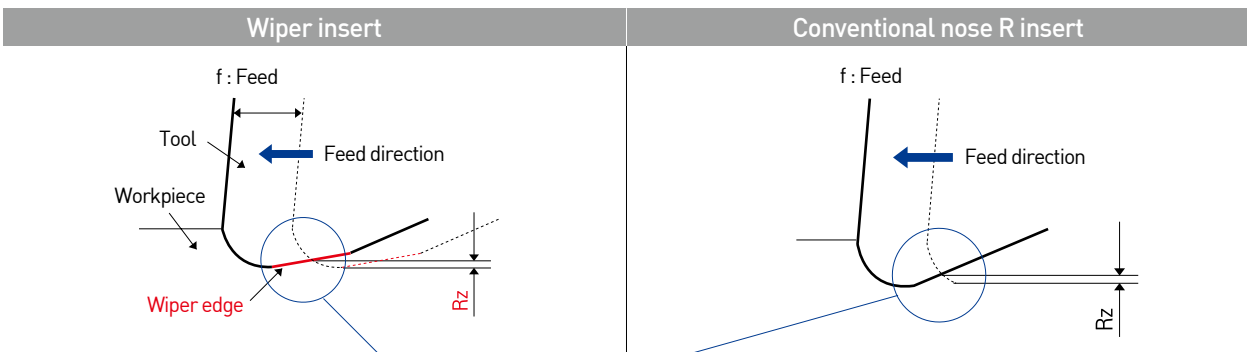
Purpose

CT reduction

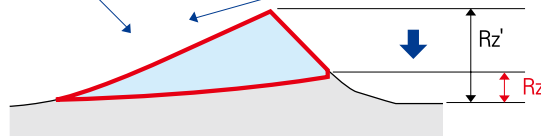
Tool service life increased

High surface roughness required

Features and performance of wiper insert



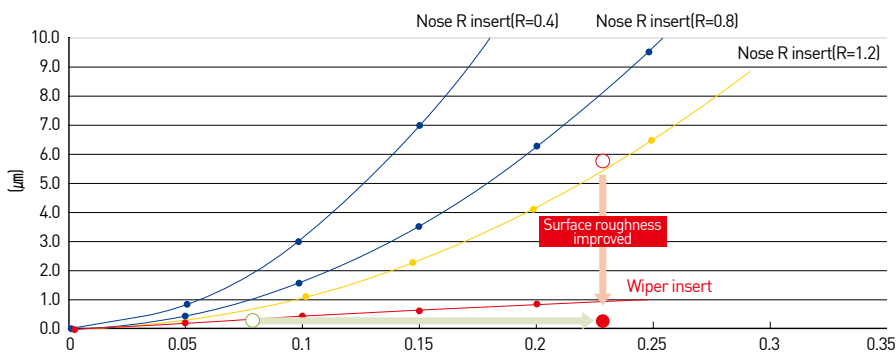
According to wiper cutting edge, the surface roughness R_z is getting smaller even in case of cutting with the same feed.



Features

1. Surface roughness improved
2. High efficiency machining based on high feed (when the surface roughness is the same)

Theoretical surface roughness of wiper insert



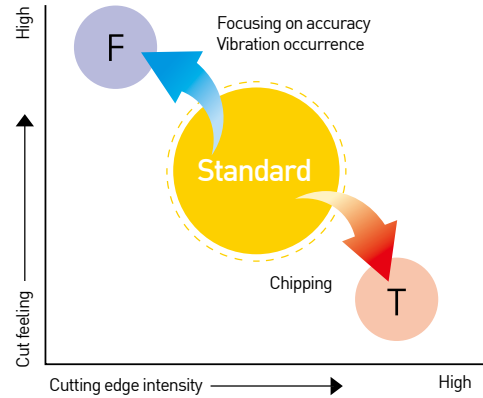
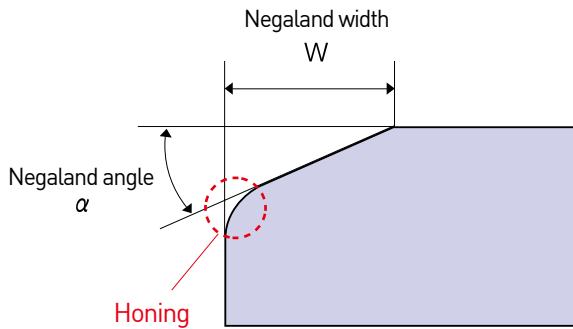
- Based on the wiper effect, surface roughness was increased 3-5 times on the same conditions!

※The details may vary according to machining environments.



Characteristics of cBN cutting edge

cBN cutting edge treatment



CNGA120408F / CNGA120408 / CNGA120408T

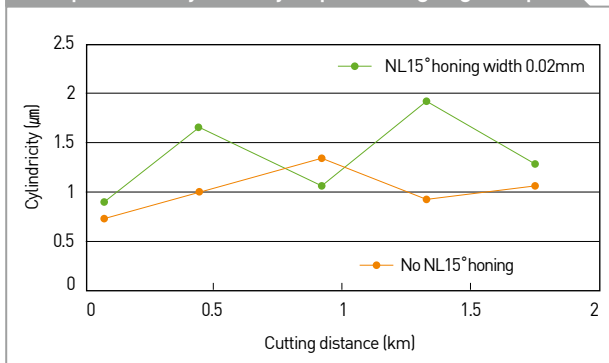
Item	Marking	Heat-treated steel			Cast iron/sintered alloy		
		Honing	Negaland width	Negaland angle	Honing	Negaland width	Negaland angle
Sharp	F	○	0.12	15-degree	-	-	-
Standard*	None	○	0.12	25-degree	N/A	0.12	15-degree
Reinforced	T	○	0.12	35-degree	N/A	0.12	25-degree

- First recommended cutting edge treatment : standard type*
- Apply sharp / reinforcement types according to machining conditions

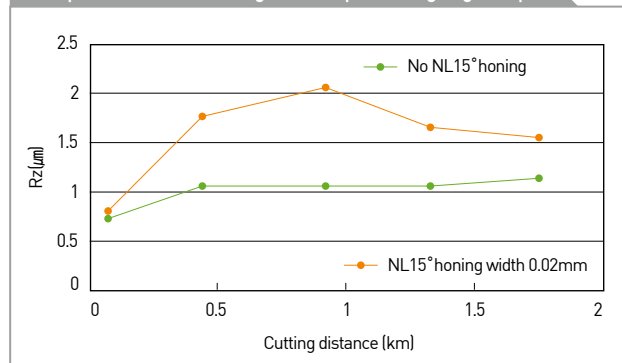
Adjust Negaland width and angle and honing amount appropriately for machining

Characteristics of cBN honing

Comparison of cylindricity as per cutting edge shape



Comparison of surface roughness as per cutting edge shape



- SCM415 Ø10 Inner diameter boring 2NU-CNGA120408 DBNX20
- V=70m/min f=0.03mm/rev d=0.05mm DRY

Giving honing increases cutting resistance to weaken machining accuracy but tends to improve surface roughness.

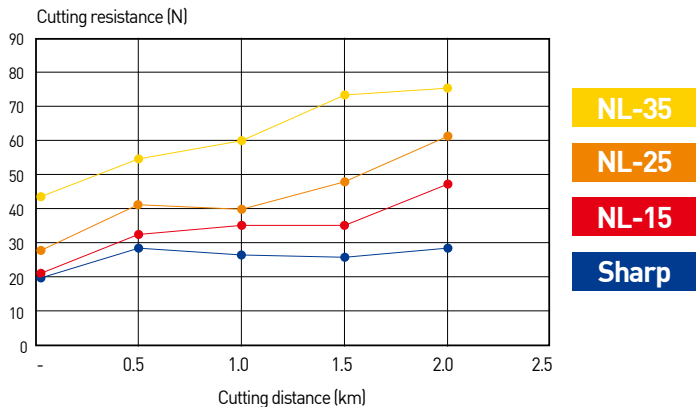
※The details may vary according to machining environments.



Characteristics of cBN cutting edge

cBN Test comparison - Negaland

Comparison of cutting resistance

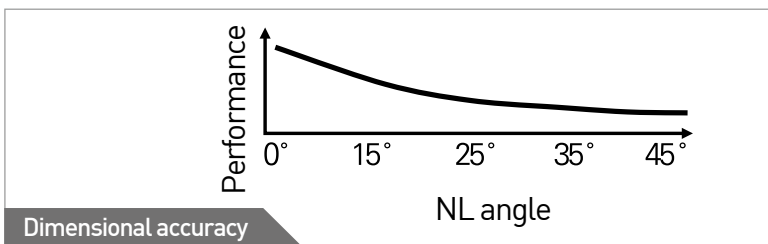


TEST information

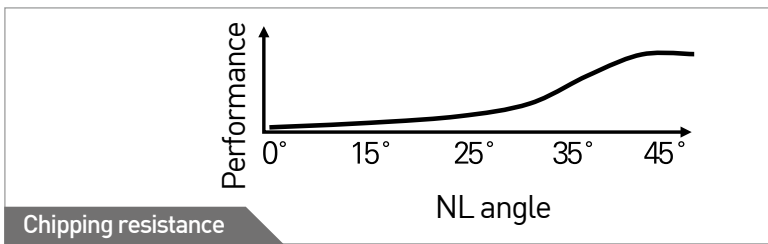
- Cutting conditions :
 - Vc 90m/min
 - fn 0.06mm/rev
 - ap 0.08mm
- Workpiece : SCM420(HRC55~57)
- Holder : DCLNR2525
- Insert : CNMA120408 / DBN250
(Standard cutting edge : Negaland angle 25°)

The smaller Negaland angle is, the smaller cutting resistance is.

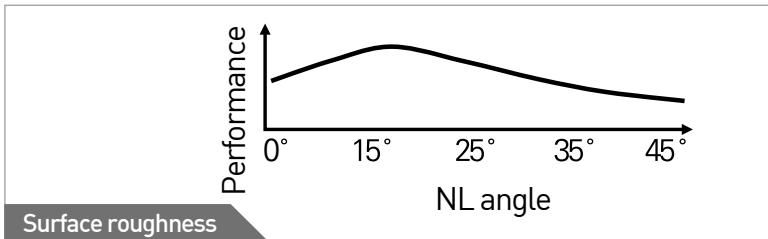
cBN (Effect of Negaland)



← Dimension accuracy increases as the cutting edge angle is getting smaller.



← Cutting edge strength increases as the cutting edge angle is getting larger.



← Surface roughness decreases as the cutting edge angle is getting larger.

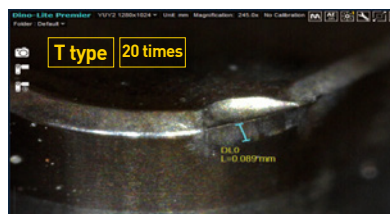
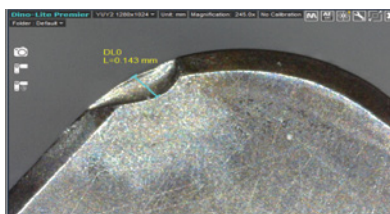
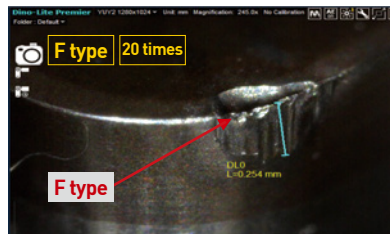
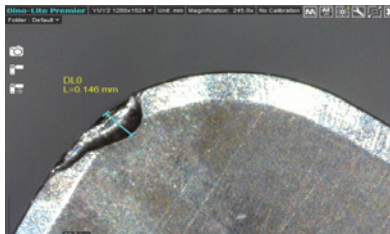
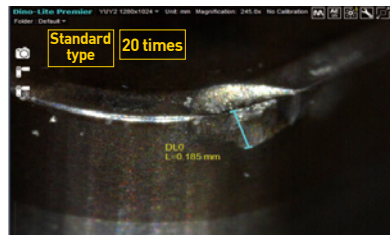
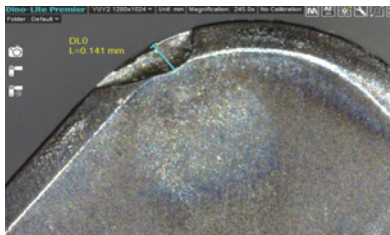
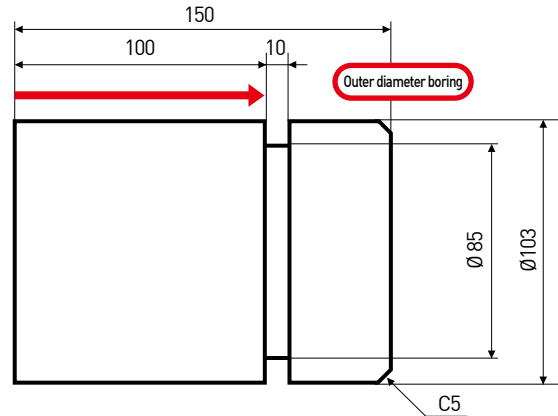


Characteristics of cBN cutting edge

cBN Test comparison - Cutting edge treatment (standard type/F type/T type)

Workpiece (round bar) information	
Size	∅105X 150
Material	SCM415
Heat treated	Carburization
Hardness	HRC58~62

Insert information 2NU-CNGA120408			
Grade	Cutting edge treatment	Negaland	Honing
DB1000	Standard type	0.12 X 25°	0.010
DB1000	F type	0.12 X 15°	0.010
DB1000	T type	0.12 X 35°	0.010



Results analysis

- Wear loss : T type > Standard type > F type
- Surface roughness : Standard type > T type > F type
- With 20 times of machining, surface roughness is machined at 8/12/20 time.
- Remarks :
- Theoretically, F type (sharp type) is excellent in surface roughness, but under the machining condition of $V=200/f=0.1/ap=0.1$, the surface roughness due to initial chipping occurrence of F type is shown inferior.

Comparison of surface roughness

Grade	8-time machining	12-time machining	20-time machining
DB1000	Ra 0.431	Ra 0.477	Ra 0.492
DB1000F	Ra 0.629	Ra 0.754	Ra 0.821
DB1000T	Ra 0.496	Ra 0.545	Ra 0.584



How to select re-grinding

1. Check for abnormality or brokenness through inspection
2. Classify re-grinding according to the size of an inscribed circle

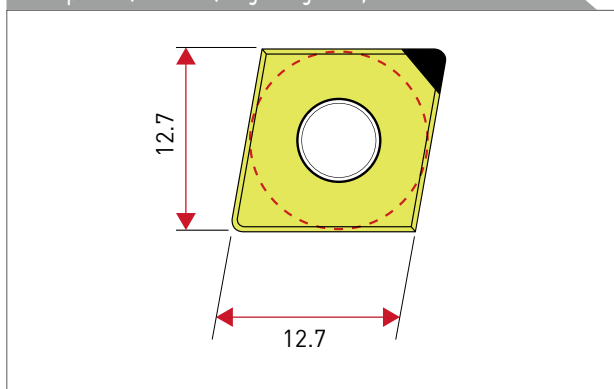
How to select re-grinding

Model No.	New product (before use)	Class B	Class C	Class D
CNMA1204□□	12.7	12.5	12.3	12.1
DNMA1504□□	12.7	12.5	12.3	12.1
VNMA1504□□	9.525	9.4	9.3	9.2
DCGW11T3□□	9.525	9.3	9.1	X
CCGW09T3□□	9.525	9.3	9.1	X

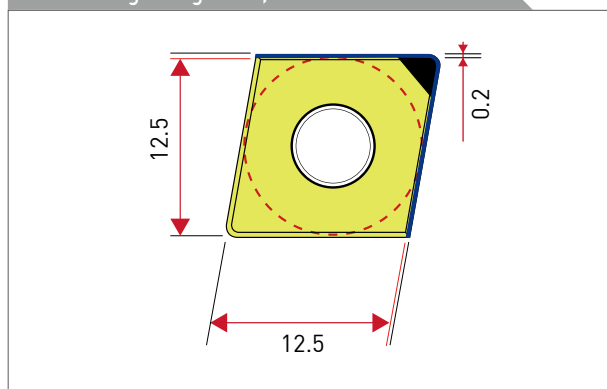
Machining example

CNMA120408 -> 0.2mm machined at one time machining

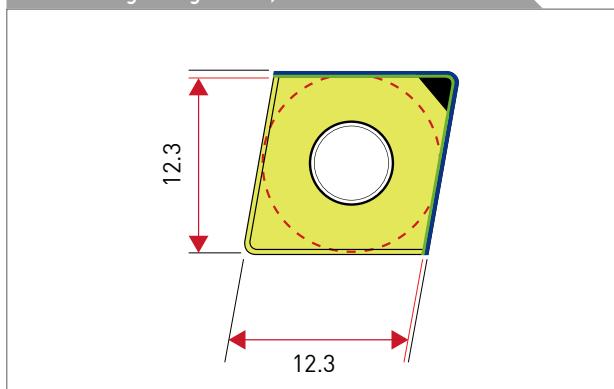
New product (before use): Regrinding 0 time, inscribed circle 12.7mm



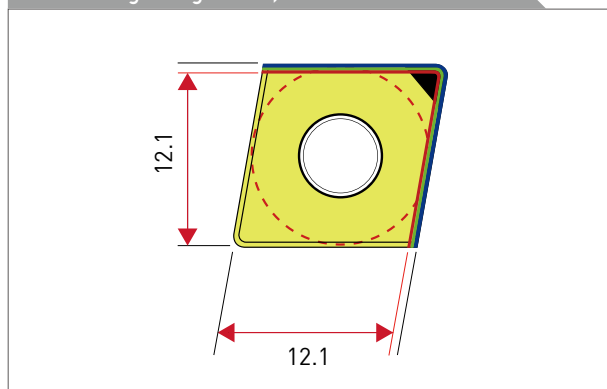
Class B: Regrinding 1 time, inscribed circle 12.5mm



Class C: Regrinding 2 times, inscribed circle 12.3mm



Class D: Regrinding 3 times, inscribed circle 12.1mm





PCD Features

DINE PCD products provide very high accuracy and excellent wear resistance as they are manufactured by the ultrahigh temperature and ultrahigh pressure manufacturing process to combine diamond polycrystallines in high density.

Also as the PCD products are based on the diamond crystal particle size control technology by DINE Inc., various workpieces can be machined widely. DINE PCD products provide excellent workpiece surface roughness, high machining accuracy and long tool service life.

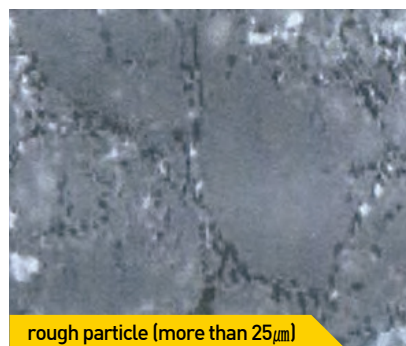
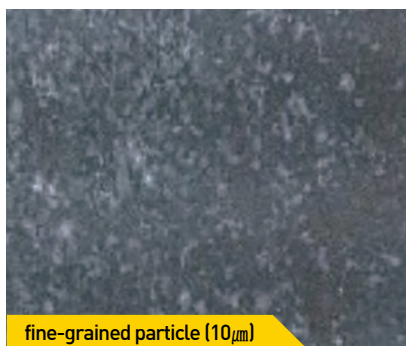
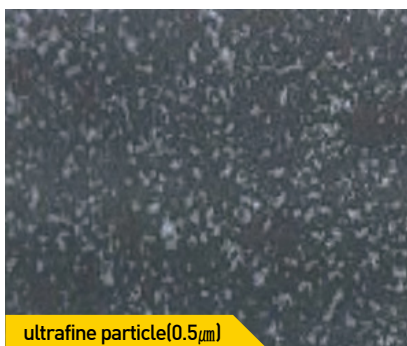
- Excellent in machining aluminium alloys and copper alloys
- Excellent in machining ceramic, high Si-aluminium alloy, stone, etc.
- Excellent in machining rubber, carbon, graphite, wood, etc.

PCD Shape



PCD Tool technology guide

1. PCD = polycrystalline diamond = particle sintered diamond
2. Composition : [diamond crystal grain + diamond additives (metal, ceramic)]
sintering by high temperature and pressure (1200°C, 50k atm)
3. Particle size : ultrafine particle (0.5µm) < fine-grained particle (10µm) < rough particle (more than 25µm)



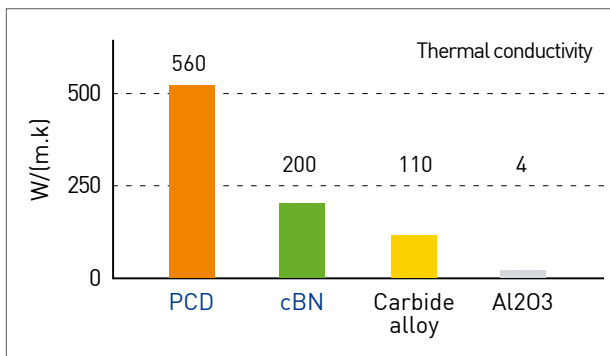
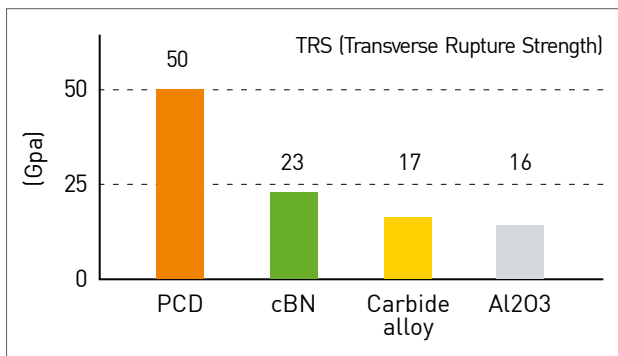
4. Application : nonferrous metals, glass fiber, woodwork, high-hardness plastic

5. Specification

- 1) rough particle => high density and thermal conductivity - excellent wear resistance but weak surface roughness.
- 2) Cutting edge oxidation occurs in case of machining high-hardness materials at low oxidation temperature



PCD



Comparison of cBN and PCD

		cBN	PCD
Thermal stability	In atmosphere	Stable up to ~1300°C	Oxidation occurs at 700°C
	In vacuum	Stable up to ~1500°C	Stable up to ~1400°C
Applications		Heat-treated steel, high-hardness materials	Nonferrous metals, glass fiber, woodwork, high-hardness plastic

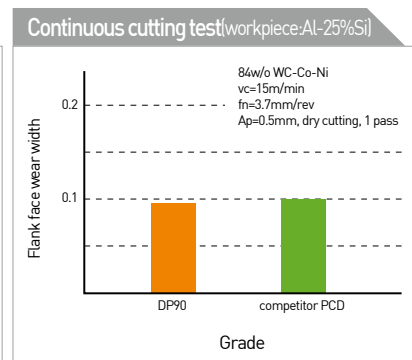
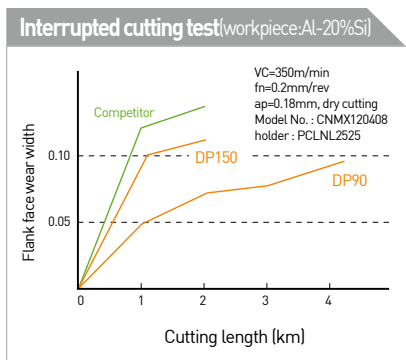
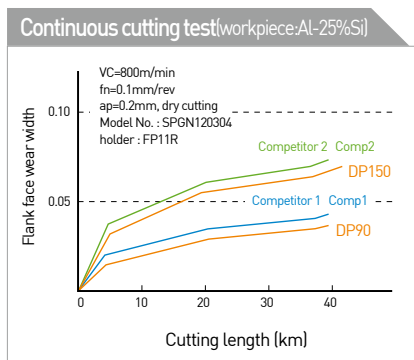
PCD Grade

Grade	Features	Applications	Particle size (μm)	Particle	Hardness (Hv)	Deflective strength (kgf/mm ²)
DP90	The largest grade diamond content by sintering rough diamond particles; Excellent wear resistance	High silicon Al alloy machining, Al composite material machining, cemented carbide alloy machining, rough boring of cemented carbide alloy, ceramic semi-sintered parts, and compound products, ceramic sintered parts machining, stone and rock machining	≥25		10,000 ~ 12,000	110
DP150	The same-size grade diamond particle by sintering fine-grained diamond particles; good coherent grade with workpiece machinability and wear resistance	General grinding machining of nonferrous metals; grinding surface machining of cemented carbide alloys, ceramic sintered parts, and compound products; cross-sectional machining of FRP, hard rubber, graphite, wood, and mineral board, etc.	10		10,000 ~ 12,000	200
DP200	Good sharpness and excellent tenacity of grade cutting edge by sintering ultrafine diamond particles	General grinding machining of nonferrous metals; grinding surface machining of cemented carbide alloys, ceramic sintered parts, and compound products; cross-sectional machining of FRP, hard rubber, graphite, wood, and mineral board, etc.	0.5		8,000 ~ 10,000	220



Recommended Cutting Conditions

Workpiece	Cutting speed	Feed	Single cutting depth	Recommended grade	
				1st	2nd
Aluminium alloy (4%~8%Si)	1,000~3,000	0.1~0.6	~3	DP150	DP200
Aluminium alloy (9%~14%Si)	600~2,500	0.1~0.5			
Aluminium alloy (15%~18%Si)	300~700	0.1~0.4			
Copper alloy	~1,000	0.05~0.2	~2	DP150	DP200
Reinforced plastic		0.1~0.3			
Wood	~4,000	0.1~0.4	-		
Cemented carbide	10~30	~0.2	~0.5	DP90	DP150



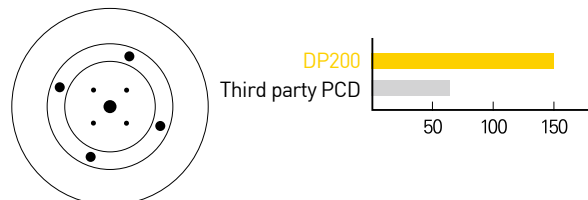
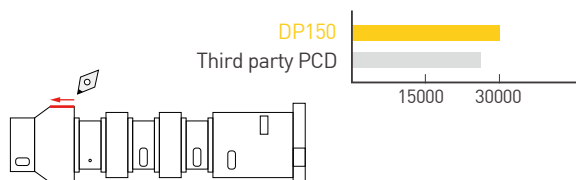
Machining example

DP150 TEST RESULT

Grade	DP150	Company A PCD
INSERTS	DCMT11T304-UC	
Parts name (workpiece)	Compressor piston (AL A4000)	
Vc(m/min)	400-450	
f(mm/rev)	0.12	
apl(mm)	1.0 ~ 1.5	
Dry/wet cutting	Wet cutting	

DP200 TEST RESULT

Grade	DP200	Company A PCD
INSERTS	NF-SEN09T3ADTR	
Parts name (workpiece)	Ring spec. outer diameter (AL6061)	
Vc(m/min)	380	
f(mm/rev)	0.1	
apl(mm)	0.15	
Dry/wet cutting	Dry/wet cutting	



※The details may vary according to machining environments.



PCD Chip Breaker(UC)

New PCD insert with Chip Breaker



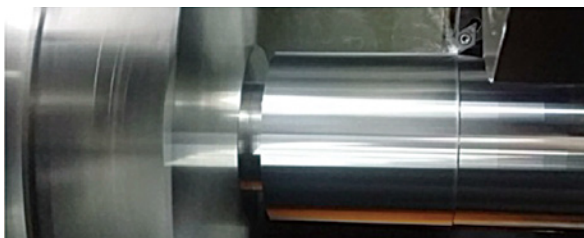
Features

- Productivity improved by resolving chip troubles
- Stable capacity to break chips in the large cutting area
- Excellent in machining aluminium and copper alloys
- Provides very high hardness and excellent wear resistance due to high-density combination of diamond polycrystallines

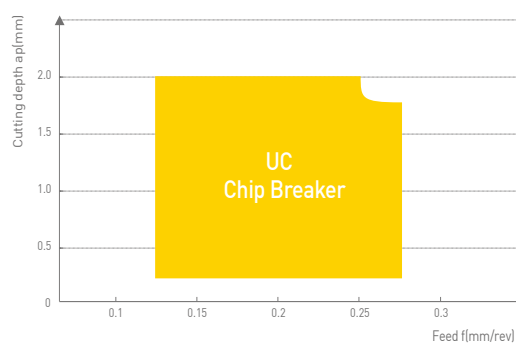


Performance Comparison Test

- Tool model no. : DCMT11T304-UC
- Workpiece: AL6061 (Ø 100*160L outer dia. boring)
- Cutting conditions : Vc=500m/min, f=0.15mm/rev, ap=0.2mm, dry cutting



Applicable area



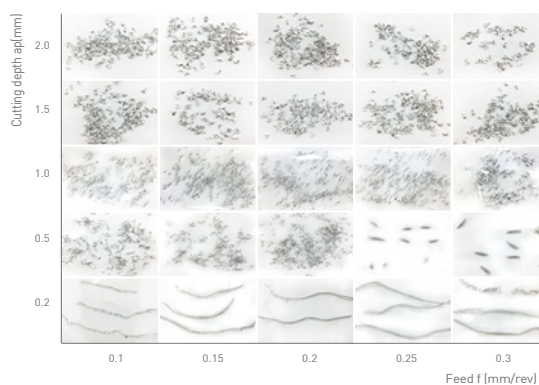
General type PCD



UC Chip breaker

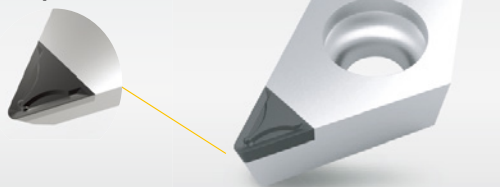
Shape of chip

- Tool model no. : DCMT11T304-UC
- Workpiece: AL6061 (Ø 100*160L outer dia. boring)
- Cutting conditions : Vc=500m/min dry cutting



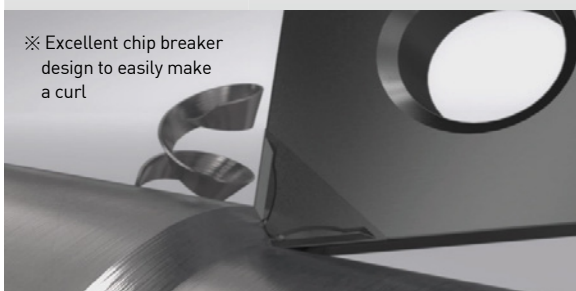
Chip Breaker

UC Chip Breaker

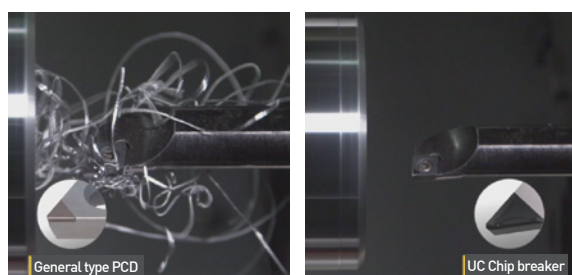


※ Excellent chip breaker design to easily make a curl

※ Excellent chip breaker design to easily make a curl



Comparison of chip rear discharge

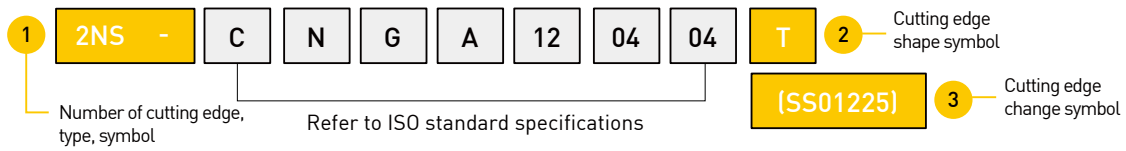




How to indicate the Model No. of Insert

How to indicate cBN cutting edge

Model No. example



1 Number of cutting edge, type symbol

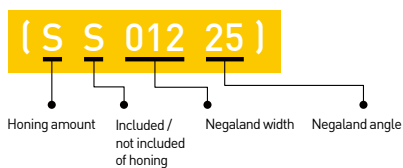
Item	Symbol description	Symbol description
Number of cutting edge	None	1 corner type
	2, 3, 4 ...	multi-corner type

Item	Symbol description	Symbol description	Shape
Type Symbol	None	Re-grinding type	
	NU	One use type, corner type	
	NS	NS type	
	NT	NT type	

2 Cutting edge shape symbol

Symbol	Symbol meaning	Symbol description		
None	Standard type	ISO standard insert		
F	Low resistance type	Workpiece	Standard	F
		Heat-treated steel grade	25°	15°
		Cast iron grade	15°	0°
		Wiper insert	15°	-
T	Cutting edge reinforced type	Workpiece	Standard	T
		Heat-treated steel grade	25°	35°
		Cast iron grade	15°	25°
		Wiper insert	15°	25°
W	Wiper type	Wiper insert		
-GA -RA	Chip breaker type	-GA : fine-boring chip breaker -RA : rough-boring chip breaker		

3 Cutting edge change symbol



Honing amount		Honing		Negaland width	Negaland angle
S	Small	S	Existence	012	25
M	Medium	T	Non-existence	-	-
L	Large				

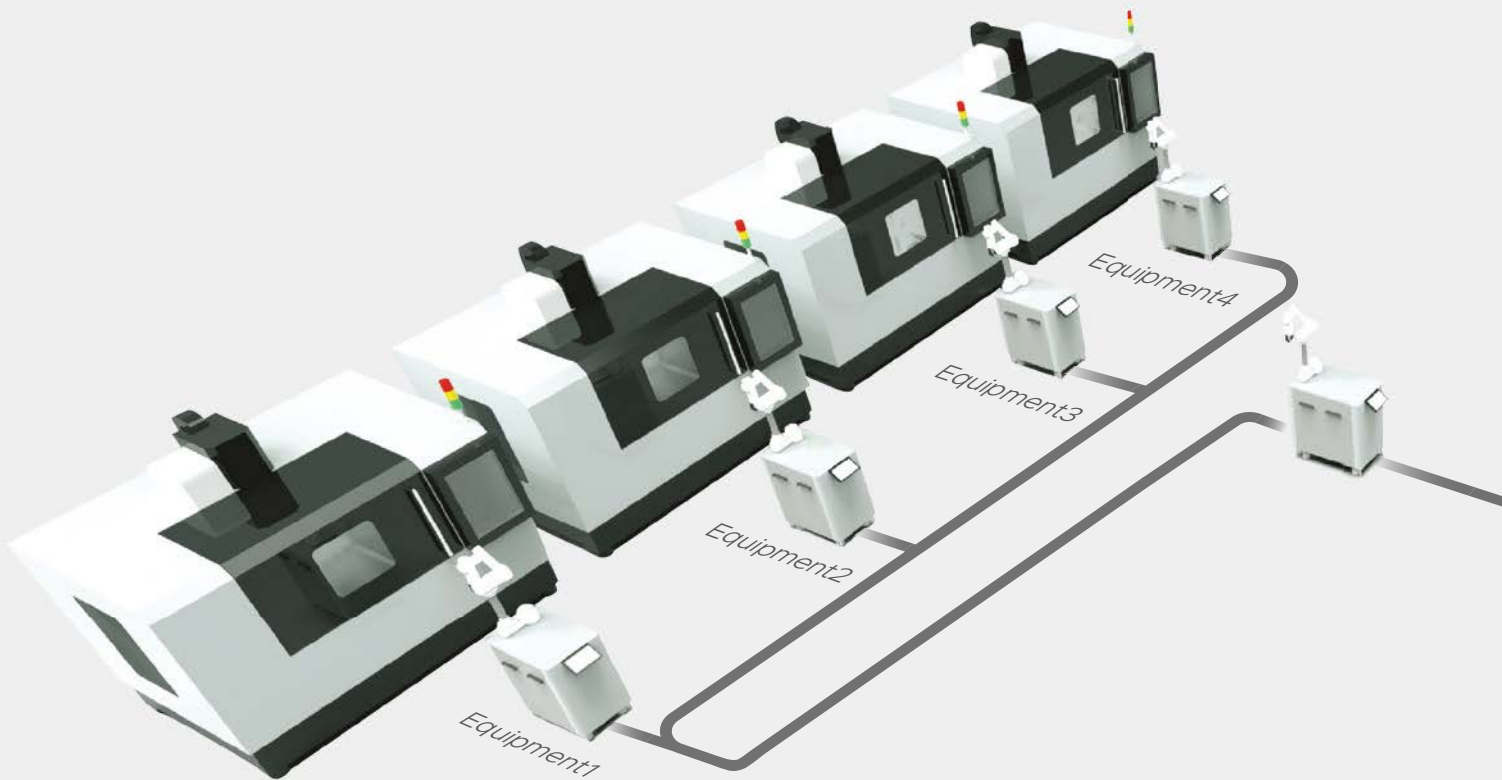


Smart factory

DINOX NC TOOLING SYSTEM

SMART FACTORY	268
MDM S/W SYSTEM	270
Collaborative Robot (Domestic Sales Only in Korea)	272
DINE'S COBOT (Domestic Sales Only in Korea)	272
TOOL MASTER (Domestic Sales Only in Korea)	276
TOOL MASTER LITE (Domestic Sales Only in Korea)	277
TOOL MASTER BASIC (Domestic Sales Only in Korea)	278
TOOL MASTER QUADRA (Domestic Sales Only in Korea)	279

DINE's Collaborative Robot solution that coexists with humans and creates new values



Collaborative Robot (Collaborative Robot)

- Optimized for repetitive work in a small space
- Effective for heavy work burdensome for humans

Tool Master (Tool presetter)

- Measures length correction values for tools in advance
- Setting time shortened / equipment downtime reduced

MDM (Tool management S/W)

- Tool holder information management → tool diameter, length, storage location
- Integrated management for tools, production, CAM, etc.



Chuck

Arbor / Modular

Boring tool

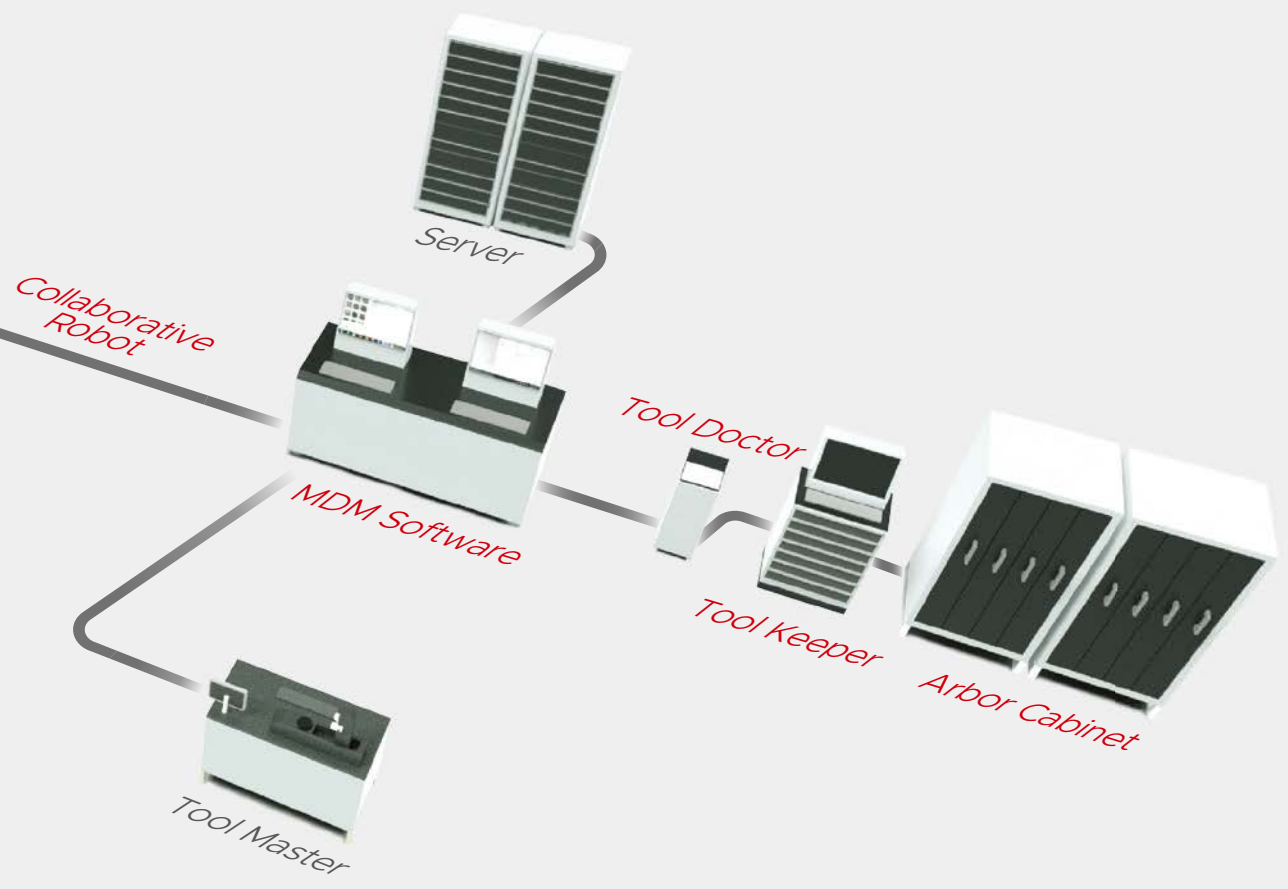
Angular head

cBN/PCD

Smart factory

TAUMAX

OTHER



Tool Doctor (Monitoring system)

- Manages production defect in mass-production process
→ Tool damage, non-machining, re-machining
- Manages the trend of tool service life

Tool Keeper (Tool management equipment)

- Day/night entering & release control
- Systematic inventory and order management
- Manages the transparency of tool usage results

Arbor Cabinet (Arbor dedicated storage box)

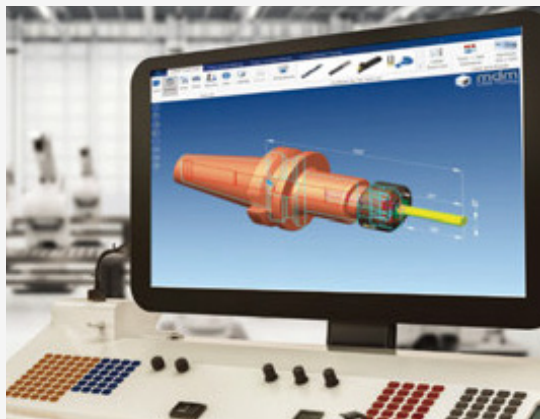
- Functionality of increasing space efficiency and protecting tools (foreign substance inhibited on the site)
- Operates virtual warehouse for Tool Keeper (tool location / quantity management)



MDM S/W SYSTEM

Total tool management system that enables the user to identify tool information about tool diameter, length, storage location, etc. stored in the server only by reading the 2D bar code printed on the tool (chuck). It helps all users share information so that work can be performed in an accurate and fast manner.

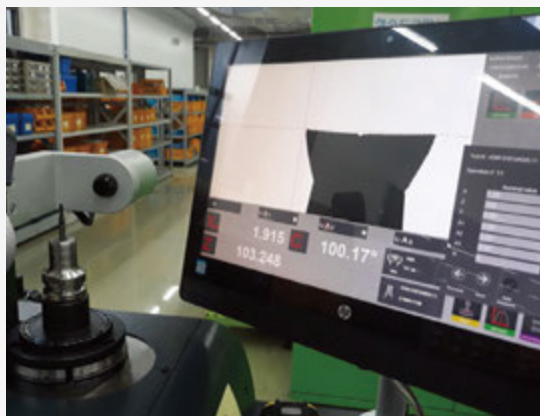
MDM System



- Assemble by searching the end tool and chuck by equipment and by process
(The protrude length of the assembly tool adjustable)
- Reduction, enlargement, and rotation of shapes available
- Through modeling of shapes



- Cutting conditions can be set according to workpiece, tool, machining equipment, etc.
- Can be utilized throughout all departments by establishing the standardized cutting machining data



- Automatic measuring system using the bar code
- Automatic transfer measured data values to MCT
- Permissible tolerance test of the usable tool available
(comparison of actually measured value vs. setting tolerance)

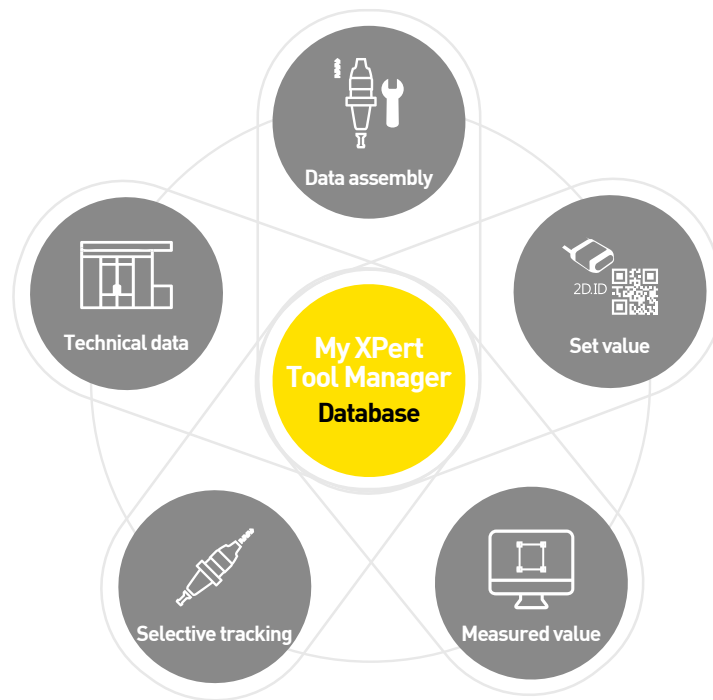


- Spot stock can be identified in real time
(The protrude length of the assembly tool adjustable)
- Preemptive inventory management process available
(priority order appropriate for safe quantity, etc.)

MDM Introduction effect

	Improves productivity through a shorter C/T	<ul style="list-style-type: none"> Productivity is increased 20~30% through a shorter time for tool setting and measurement.
	Builds an integrated management system	<ul style="list-style-type: none"> Integrated management for tools, production, and CAM, etc. is available.
	Increases convenience and decreases defects	<ul style="list-style-type: none"> Human errors can be prevented by automatic measurement data transfer.

MDM System Cycle



Data assembly	<ul style="list-style-type: none"> Assemble the tool according to database plan/ parts list to which tool holder 2D ID is allocated.
Set value	<ul style="list-style-type: none"> Deploy the tool to the presetter and scan 2D ID. Get the set value and measuring function from the database.
Measured value	<ul style="list-style-type: none"> Measure the tool with the tool presetter and store a measured value in the central database in an automatic manner.
Selective tracking	<ul style="list-style-type: none"> Re-measure or disassemble the tool in case of tool change
Technical data	<ul style="list-style-type: none"> Set up the measured tool on the equipment and 2D ID is detected in the equipment. Exchange information with the CNC control.



Collaborative Robot

Doosan Robotics' official distribution partner
Meet DINE's more varied collaborative robot solutions.

M Series

- Provides the world's top class stability
- Enables exquisite and delicate work
- Enables various work operations including bolting and polishing



A Series ^{NEW}

- Provides the lowest price in the industry
- Faster work speed
- Suitable for simple and repetitive work



Model No

M Series

M0609

- Payload 6kg
- Operating radius 0.9m

Optimized for fast repetitive work in a small space

M0617

- Payload 6kg
- Operating radius 1.7m

Efficient for 2 processes at least or long distance work

M1013

- Payload 10kg
- Operating radius 1.3m

Basic model fit for all work processes

M1509

- Payload 15kg
- Operating radius 0.9m

Effective for heavy goods work burdensome for humans

A Series

A0509

- Payload 5kg
- Operating radius 0.9m

Optimized for fast repetitive work in a narrow space

A0912

- Payload 9kg
- Operating radius 1.2m

Collaborative robots with fast behavior speed appropriate for all work

What is Collaborative Robot?



Safe & Fenceless

- Its built-in collision detection function protects the operator against collision
- Enables fenceless collaboration with the operator in a work environment



Easy

- Its easy programming solution enables the operator to easily change work setting in case of process change
- The customer can directly change the program through simple training.



Flexible

- Easy and simple installation. Can be installed within a small space without changing the conventional layout.
- Its 6 torque sensors enables high level tasks.

Option

M Series

Direct Control Unit-Cockpit



Ideal option that can maximize the convenience of direct teaching

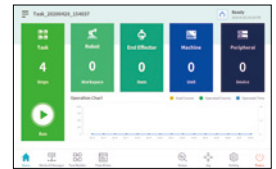
Anti Stain Paint (Navy Color)



Dust and pollution proof paints used

Common option

Dart Platform



Software that enables the control of the robot from a PC

A Series

Direct Control Unit-Cockpit



Ideal option that can maximize the convenience of direct teaching

Smart Pendant



Ultra-small pendant only with necessary functions

FT-Sensor



Precise force detection sensor necessary for exquisite and delicate work (6-axis single mounting)

Accessories

Water Jacket



Moisture infiltration prevented to protect the robot from being polluted by liquids

Mobile Base



Robots and controllers embedded to be moved and redeployed freely on the site

Smart Vision Module



On-board image process that enables vision work without a separate PC

Dress Pack



Arrange various harnesses connected to the end tool of the robot for work efficiency



DINE'S COBOT

WE COEXIST WITH HUMANS

DINE's cobot model line-up

M0609

- Robot with 6kg of payload and 0.9m of operating radius
- Optimized for fast repetitive work in a small space

- Payload : 6kg
- Reach : 900mm



M0617

- Robot with 6kg of payload and the industry's longest operating radius (1.7m)
- Most efficient for 2 work processes at least or long distance work

- Payload : 6kg
- Reach : 1,700mm



M1013

- Robot with 10kg of payload and 1.3m of operating radius
- Basic model fit for all work processes

- Payload : 10kg
- Reach : 1,300mm



M1509

- Robot with the industry's largest payload (15kg) and 0.9m of operating radius
- Effective for heavy goods work burdensome for humans

- Payload : 15kg
- Reach : 900mm



A0509 NEW

- Robot with 5kg of payload and 0.9m of operating radius
- Entry-type collaborative robot fit for fast repetitive work in a narrow space

- Payload : 5kg
- Reach : 900mm

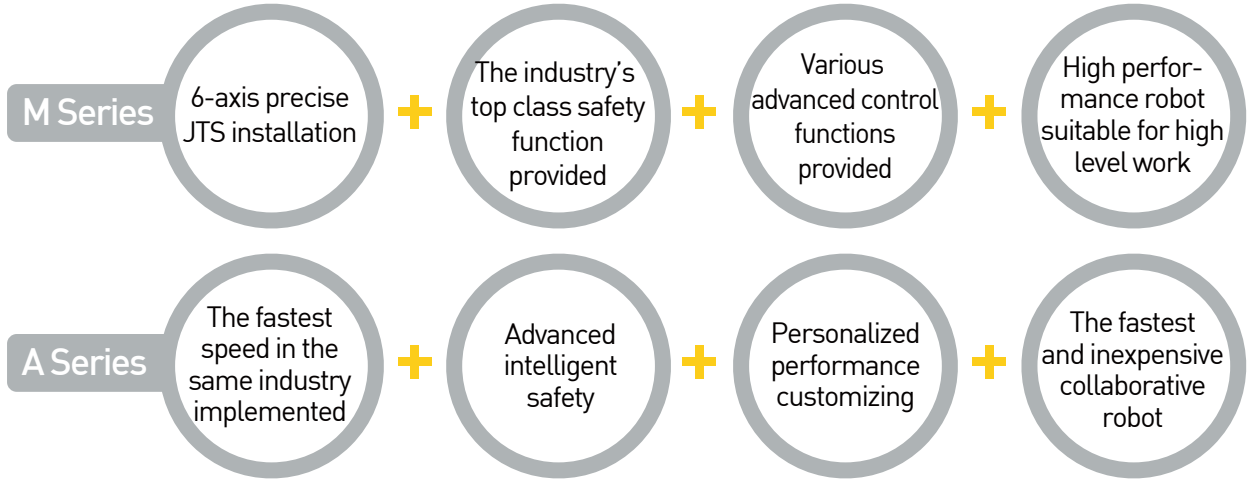


A0912 NEW

- Robot with 9kg of payload and 1.2m of operating radius
- Entry-type collaborative robot fit for all work processes with fast behavior

- Payload : 9kg
- Reach : 1200mm





Application

<p>Machine tending</p>	<p>Bolting</p>	<p>Gluing</p>	<p>Packaging</p>
<p>Handling</p>	<p>Loading</p>	<p>Assembling</p>	<p>De-burring</p>
<p>Test</p>	<p>Inspection</p>	<p>AGV</p>	<p>Catering</p>

Chuck

Arbor / Modular

Boring tool

Angular head

cBN/PCD

Smart factory

TAUMAX

OTHER



TOOL MASTER

Swiss Made/Produced

Domestic Sales Only(in Korea)

Tool Master is a tool presetter by Swiss EVOSET with more than 25-year's experience.

Tool presetter : equipment that measures length correction values for tools before installation in the equipment

Why use it? : It helps cost reduction through productivity improvement due to reduced equipment downtime as well as a shorter setting time.

the smart way of tool presetting!

Payback formula

Using Tool Master reduces a setting time by about 3 minutes per tool.

For example, if you re-setup 20 tools 4 times in a week, you will get another 240 minute production time in a week and additional 192 hours in a year. Multiplying it by your company's equipment production cost per hour, you will get cost reduction to be obtained by using Tool Master. You can calculate an investment payback period through this.

Be sure to consider Tool Master in the case of the company with equipment and tools or the company that frequently sets up tools.

70 seconds



Tool Master 0

250 seconds



Tool Master X

Full line-up of TOOL MASTER

	TOOL MASTER Lite	TOOL MASTER Basic	TOOL MASTER Quadra
Version	Economy type	General entry type	General type
Measurement method	Contact type	Non-contact type (camera)	Non-contact type / Contact type (option)
Scale	General scale	Sylvac scale	Glass scale
Measuring range Norm. (∅mm/Lmm) Max. (∅mm/Lmm)	X250 / Z0 ... Z300	X400 / 40 ... 600 Z400 / 40 ... 600	X400 / 40 ... 600 Z400 / 40 ... 600
Rapid feed	Manual (by hand)	By pressing the handle button	By pressing the handle button
Tool port	Needle bearing ISO40/50	Needle bearing ISO40/50	Needle bearing ISO40/50 or ISO40/50 KV spindle (Air intake spindle)
Measurement method	Digital reader (0.01mm)	EyeRay® Hawk	EyeRay® Buzzard or Hawk TipRay with Dial indicator



TOOL MASTER LITE

Swiss Made/Produced

Domestic Sales Only(in Korea)

TM Lite is a simple-design economy-type tool presetter that can only measure simple diameter and tool length.

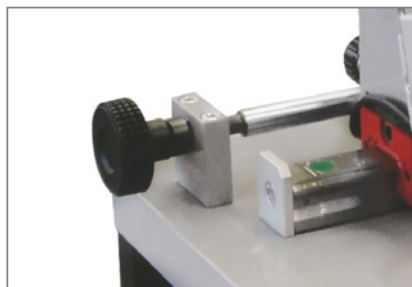


Features

- Tool setting time reduced
- Excellent quality versus price (economy type)
- Easy operation due to simple structure
- Needle bearing tool port
- Digital reader (0.01mm unit)
- No electricity or air needed .
- Weight : 23KG
- Size : 410 x 150 x h540
- AA battery

TECHNICAL DATA

Item	Manual drive
Measurement range	∅ mm 250 / L mm 0...300
How to fix the axis	Mechanical type
Fine-adjustment	X axis fine tuning
Measured value indication unit	0.01mm
How to measure	Contact type using a cemented carbide tip



Chuck

Arbor / Modular

Boring tool

Angular head

cBN/PCD

Smart factory

TAUMAX

OTHER



TOOL MASTER BASIC

Swiss Made/Produced

Domestic Sales Only(in Korea)

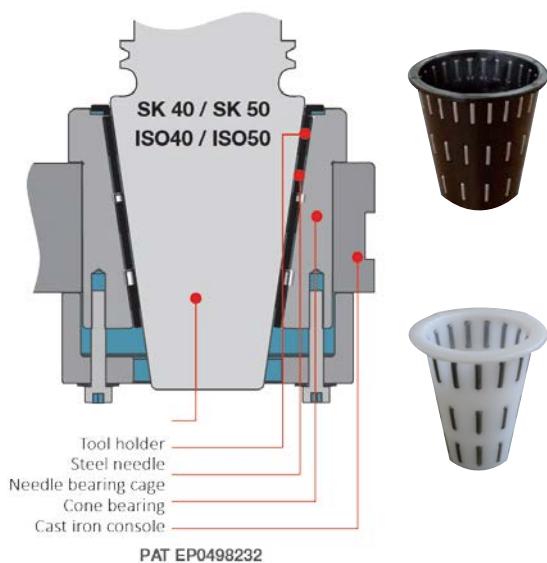
TM Basic is an economical and efficient start-up solution with all standard measurement functions.



Features

- Plug & Work solution
- Simple operation method
- Compact structure and robust body
- HP-PC 20" screen solution
- Fast cutting edge focusing
- Telecentric lens type CMOS camera
- High concentricity
- Best repetitive accuracy
- ISO 50 or ISO 40 integral tool port
- PWB EyeRay® Hawk software
- X axis and Y axis endless fine tuning

Patent: Needle Bearing



TECHNICAL DATA

Item	Manual drive
Measurement range	∅ mm 400 / L mm 40 400 ∅ mm 400 / L mm 40 600
How to fix the axis	Pneumatic
Fine-adjustment	X-, I-, Z-axis hand wheel
Tool mounting	Rotary clamping or air injection type needle bearing or KV spindle
How to measure	Image processing through EyeRay® Hawk



TOOL MASTER QUADRA

Swiss Made/Produced

Domestic Sales Only(in Korea)

TM Quadra is a fast and simple manual presetter with a high-accuracy measurement method suitable for all users.



Features

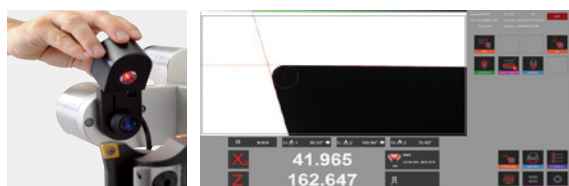
- Manual operation at X, I, Z, and C axes
- EyeRay® software HWAK or BUZZARD
- All in One PC 20.0" touchscreen technology
- Glass scale
- Telecentric lens type CMOS digital camera
- Cross-sectional inspection
- X axis and Y axis endless fine tuning
- ISO 50 or ISO 40 integral tool port
- Adapter and tool management
- Label printer / table
- Holder for tool storage
- Data transfer to all types of machine tools and third-party systems
- High concentricity
- Best repetitive accuracy

Applicable measurement method

TipRay : Contact type (cemented carbide tip+indicator) diameter, height only measurement



EyeRay Hawk : Non-contact type (Vision)_Basic
EyeRay Buzzard : Non-contact (Vision)_Advanced
 - Diameter, height, angle, due-diligence test, multi-cutting measurement, etc.



TECHNICAL DATA

Item	Manual drive Practical design and easy-to-use operation
Measurement range	∅ mm 400 / L mm 40 400 ∅ mm 400 / L mm 40 600 ∅ mm 400 / L mm 40 700 ∅ mm 600 / L mm 40 400 ∅ mm 600 / L mm 40 600
How to fix the axis	Pneumatic
Fine-adjustment	X-, I-, Z-axis hand wheel
Tool mounting	Rotary clamping or vacuum injection available needle bearing or KV spindle
How to measure	Image processing through EyeRay® Hawk or Buzzard

For Z axis measuring range (Z40~Z605), indicate Z6 behind the product name.
 e.g.) TM Quadra EyeRay Hawk Z605

※ For a product whose measuring range is higher than the range supported, please contact us as TM5 separately.

Chuck

Arbor / Modular

Boring tool

Angular head

cBN/PCD

Smart factory

TAUMAX

OTHER



Comparison of components and options per model

Swiss Made/Produced

Domestic Sales Only(in Korea)

Composition and option matters	TM Lite	TM Basic	TM Quadra	
		EyeRay	EyeRay	TipRay
Needle bearing spindle	0	0	0	0
KV spindle ISO50 (air intake)	X	Option		
Measurement method	Cemented carbide contact type	Non-contact 50x camera	Non-contact 50x camera	Non-contact 50x camera
Measuring Scale	General scale	Sylvac Scale	Glass Scale	Glass Scale
LED Front light test function	X	Option	0	Option
20" Monitor and built-in desktop	X	0	X	X
20" Touchscreen All-in-One PC	X	X	0	0
Mouse	X	0	0	0
Keyboard	X	0	0	0
Label printer (Brother)	X	Option	0	Option
Table	X	Option	0	Option
Tool cradle (for 3 tools)	X	Option	0	Option
Test bar included or not	X	0	X	X
Data transfer	X	Option (RFID / 2DID / Post Processor)		
Weight of maximum measurable tool	20Kg	50 Kg		
Power supplied or not	Battery (AA)	Necessary		
Air supplied or not	Unnecessary	Necessary		





ADAPTER

Swiss Made/Produced

Domestic Sales Only(in Korea)



Reduction ISO50 / 40 : ISO available for ISO 10 / 15 / 20 / 25 / 30 / 35 / 40 / 45 / 50

TM Lite / Basic / Quadra



Reduction ISO50 / 40 : HSK (Form A to F) available for HSK 25 / 32 / 40 / 50 / 63 / 80 / 100 / 125

TM Basic / Quadra



Reduction ISO50 / 40 : VDI with clamp lever available for VDI 16 / 20 / 25 / 30 / 40 / 50 / 60

TM Basic / Quadra



Reduction ISO50 / 40 : VDI with index (4x90°) available for VDI 16 / 20 / 25 / 30 / 40 / 50 / 60 / 80

TM Basic / Quadra



Reduction ISO50 : Capto 'easy' available for Capto C3 / C4 / C5 / C6 / C8 / C10

TM Basic / Quadra



Clamp insert K-HSK available for HSK 40 / 50 / 63 / 80 / 100

TM Basic / Quadra

Chuck

Arbor / Modular

Boring tool

Angular head

cBN/PCD

Smart factory

TAUMAX

OTHER



TAUMAX

DINOX NC TOOLING SYSTEM

Power vise (PVT)	284
Power vise (PVTM)	285
Machine vise(MVT-154)	287
Taper cleaner	288
Shrink fit device	289
CLEAN-TEC FAN	290
Precise boring adjustment cartridge	291
Pull stud bolt wrench	291
Tool clamp	292
Magnetic base	293



Power Vise (PVT)

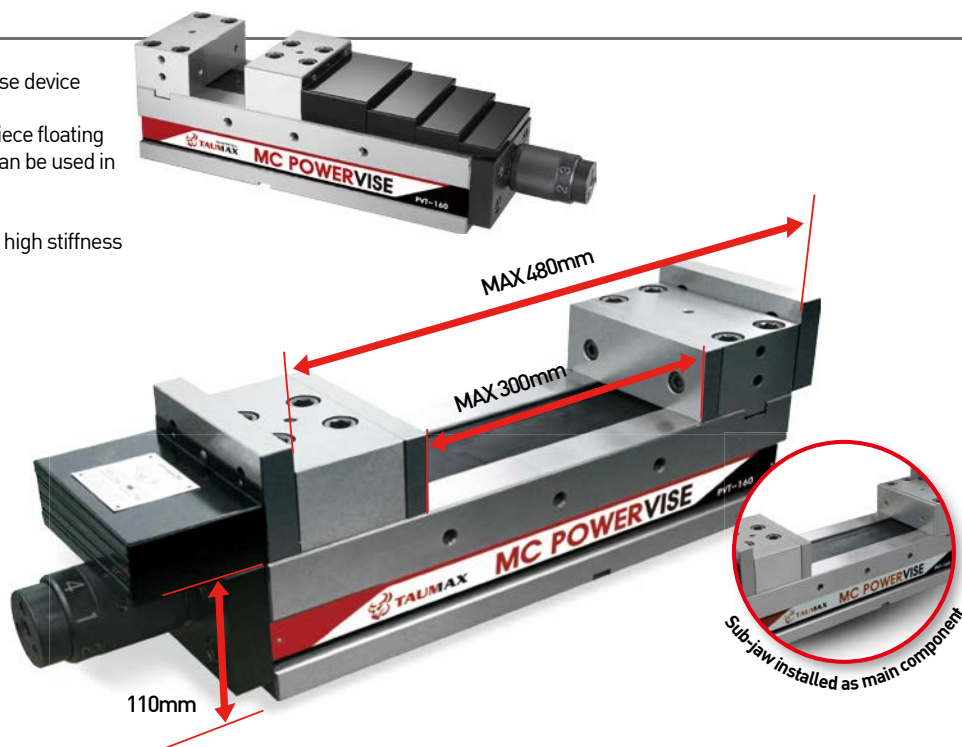
MC POWER VISE - PVT (standard type)

Features

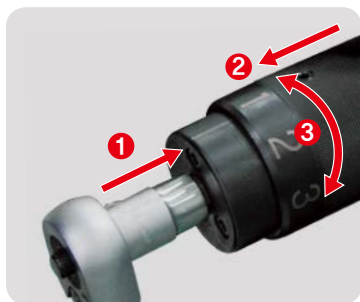
- Apparatus type power increase device adopted
- Designed to minimize workpiece floating
- Height tolerance: 0.01mm, Can be used in parallel
- Built-in IN (18T) sub-jaw
- Durability enhanced by using high stiffness materials

PVT

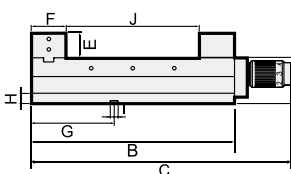
Max. opening width
(Based on 6 inches)



How to use



- ① Fix the grip after tightening by the main handle
- ② Pull the clamping force control grip toward the handle
- ③ Rotate the clamping force control grip from side to side to set the clamping force.



Clamping force

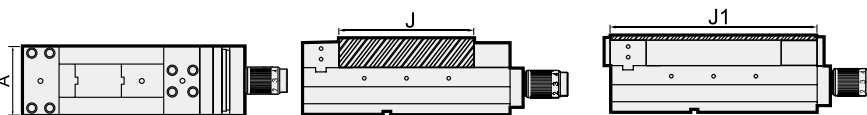
(Unit: kgf)

Grasp step	Spec.	PVT-100	PVT-130	PVT-160	PVT-200
Step 1		1,000	1,500	2,000	2,500
Step 2		2,000	2,500	3,000	3,500
Step 3		3,000	3,500	4,000	4,500
Step 4		3,500	4,500	5,000	5,500

Main components

Handle	Ratchet handle	Internal sub-jaw	Accessory

※ IN/OUT Sub-jaw is the same, available as PVT Entry Type.



Model No.	A	B	C	D	E	F	G	H	I	J	J1	Clamping force (Kgf)	Kg
PVT-100	100	310	442	85	50	75	110	25	18	150	300	3,500	29
PVT-130	130	410	542	100	55	80	135	25	18	240	400	4,500	46
PVT-160	160	490	622	110	60	85	200	25	18	300	480	5,000	68
PVT-200	200	530	662	110	60	85	220	25	18	350	520	5,000	91



Power Vise (PVTM)

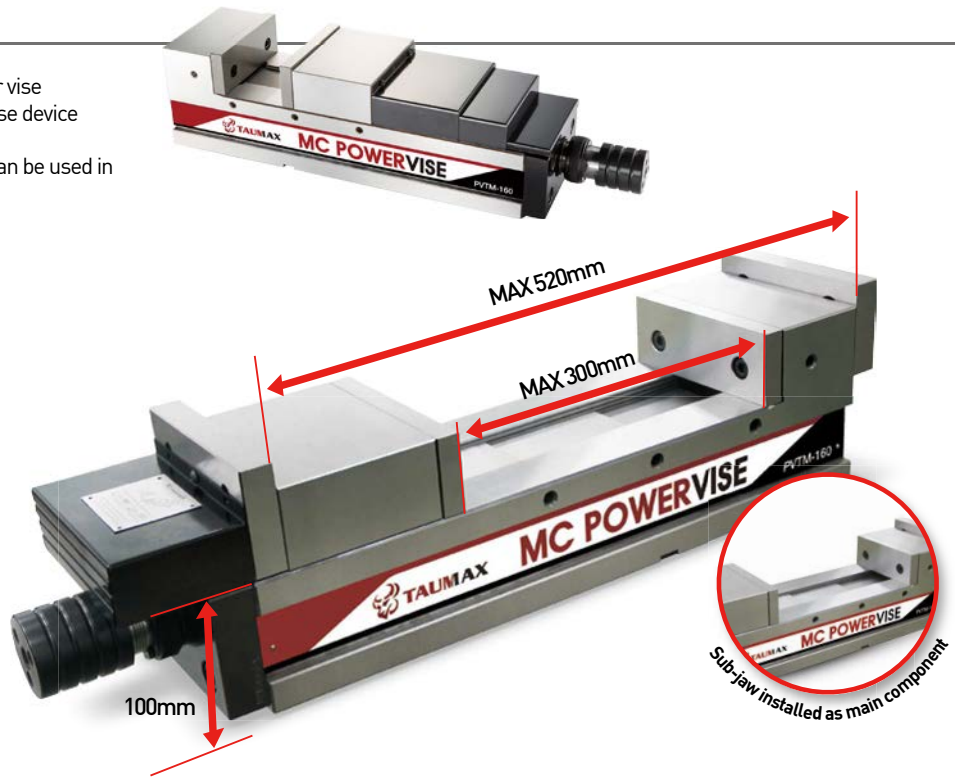
MC POWER VISE - PVTM (entry type)

Features

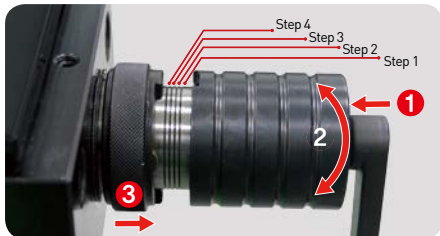
- Easy-to-use entry type power vise
- Apparatus type power increase device adopted
- Height tolerance: 0.01mm, Can be used in parallel
- Built-in IN (18T) sub-jaw

PVTM

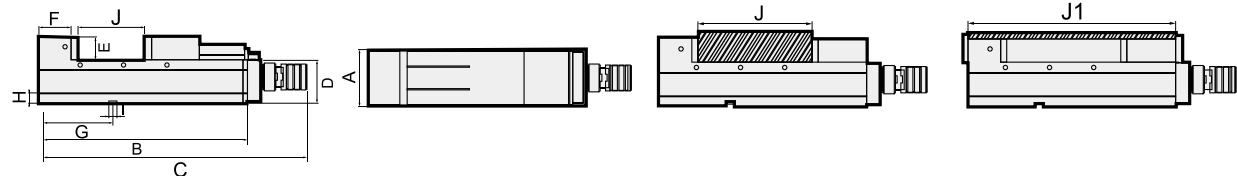
Max. opening width
(Based on 6 inches)



How to use



- ① Push it to the workpiece using the ratchet handle, a main component
- ② Apply instantaneous torque (rotation) to increase grasping power
Pull out the workpiece by turning the ratchet handle in the opposite direction after machining
- ③ Be sure to use the clutch to clamp any hard workpiece (mild steel, aluminium, copper, acryl, etc.). Otherwise, the material of the workpiece may be strained.



Model No.	A	B	C	D	E	F	G	H	I	J	J1	Clamping force (Kgf)	Kg
PVTM-100	100	395	530	85	50	60	110	25	18	200	370	3,500	28
PVTM-130	130	470	605	100	55	75	160	25	18	250	450	4,500	45
PVTM-160	160	545	680	100	60	80	200	25	18	300	520	5,000	68
PVTM-200	200	615	740	110	60	95	220	25	18	350	590	5,000	91

Clamping force

(Unit: kgf)

Grasp step	Spec.	PVTM-100	PVTM-130	PVTM-160	PVTM-200
Step 1		1,500	2,000	2,000	2,000
Step 2		2,500	3,000	3,000	3,000
Step 3		3,000	4,000	4,000	4,000
Step 4		3,500	4,500	5,000	5,000

Main components

Handle	Ratchet handle	Internal sub-jaw	Accessory

※ IN/OUT Sub-jaw is the same, available as PVT Standard Type.

Chuck

Arbor / Modular

Boring tool

Angular head

cBN/PCD

Smart factory

TAUMAX

OTHER



ACCESSORIES

ACCESSORIES

Built-in accessory



Handle



Ratchet handle

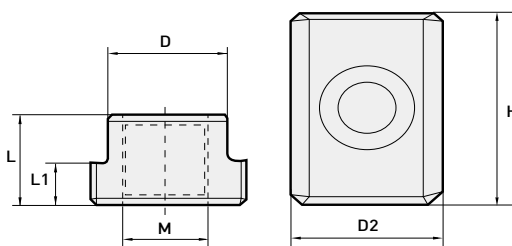


Internal sub-jaw



Accessories

Guide key



(mm)

Model No.	D	D1	H	M	L	L1
KEY-14MM+CAP-M6*P1.0*12L	14	18	25	M6	12	6
KEY-18MM+CAP-M6*P1.0*12L	18	-	25	M6	12	6

IN/OUT sub-jaw & Movable jaw/Fixed jaw

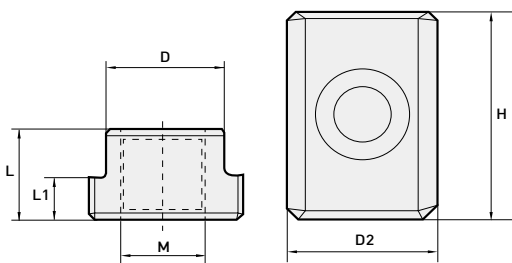


Item	Model No.	Compatibility classification
IN/OUT sub-jaw	PVT-□□□ INSIDE JAWS	PVT/M
	PVT-□□□ OUTSIDE JAWS	PVT/M
Fixed jaw	PVT-□□□ FIXED BLOCK	PVT
Movable jaw	PVT-□□□ SLIDER BLOCK	PVT

※ Sub-jaw specifications are the same as the specifications included in the conventional vise.

※ OUT sub-jaws are for separate purchase.

T-nut & Bolt



(mm)

Model No.	D	D2	H	M	L	L1	Compatibility classification	Components
T-nut & Bolt	13.8	22	28	M12*1.75(S)	16	8	PVT/M-100	T-NUT/ 4 pcs. Each washer clamp/ bolt
	15.5	25	28	M12*1.75(M)	16	8	PVT/M-100,130	
	17.5	28	31	M12*1.75(L)	19	11	PVT/M-160,200	

※ For other keys and T nut specifications, please contact us for the quotation separately.



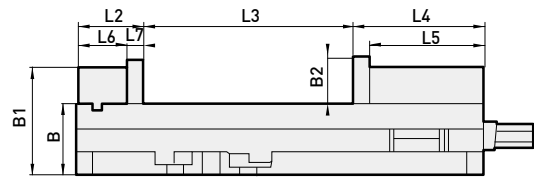
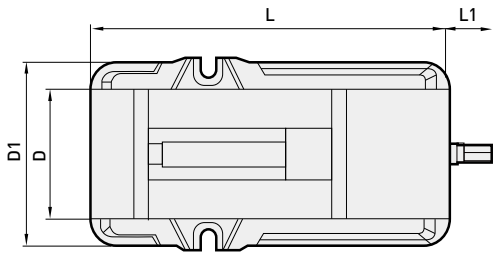
Machine Vise (MVT-154)

MC MACHINE VISE-MVT (standard type)

Features

- Provides a wide machining range (Max. opening width: 225mm)
- Durability enhanced by using high stiffness materials
- Parallel use available with basic dimensional design
- Easy to use, highly versatile machine vise

Built-in accessory



Model No.	L	L1	L2	L3	L4	L5	L6	L7	D	D1	B	B1	B2	Width	Weight (kg)
MVT-154	438	5	70	225	141	123	52	18	154	213	73	111	48	154(6")	31



FOR SEPARATE PURCHASE



Model No.	Compatible specifications
Swivel Base for MVT-154	MVT-154



TAPER CLEANER

TAPER CLEANING DEVICE

Features

- Accuracy enhanced through taper cleaning
- Tooling costs reduced by a longer cutting tool service life
- Protects the spindle of equipment
- Maintains accuracy of the contact surface for a long time
- Compact design and timer function



Item	Model No.	Diameter	Height	Kg	Power supply	Power consumption	Specifications
Lower basis	Taper cleaning drive unit	300mm	140mm	11	110-240 VAC	Max. 0.15kW	-
Upper cleaning part	Cleaning attachment ISO 30	230mm	160-190mm	10			BT/SK/CAT30
	Cleaning attachment ISO 40						BT/SK/CAT40
	Cleaning attachment ISO 50						BT/SK/CAT50
	Cleaning attachment HSK-63						HSK-63
	Cleaning attachment HSK-100						HSK-100



ACCESSORIES

ACCESSORIES



Item	Model No.	Specifications
Spare brush	Spare brush ISO 30	BT/SK/CAT30
	Spare brush ISO 40	BT/SK/CAT40
	Spare brush ISO 50	BT/SK/CAT50
	Spare brush HSK-63	HSK-63
	Spare brush HSK-100	HSK-100



SHRINK FIT DEVICE

MH-200

Features

- 30-time continuous heating available for a maximum of 1 hour (about 2 min. per tool required)
- Enables the common use of steel, SUS material holders
- All standard taper tools can be used simply by replacing the adapter flange
- Enables replacement of heating coils with a diameter of Ø25, Ø30, Ø40 or Ø55
- Prevents chuck overheating and enables manual tool cooling through settings

Easy usage setting



MH-200 Operating keypad	
START/STOP	Heating start/stop switch
SET-TIME	Heating time/cooling time setting
ADD-TIME	Overtime manual progress
COOL	Cooling device running
UP/DOWN	10-second unit time setting



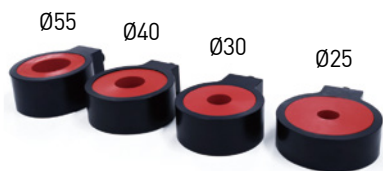
Model No.	WxLxH(mm)	Kg	Power supply	Max. power consumption	Frequency	Head operating range	Basic applicable tool diameter
MH-200	325x340x690	25	single-phase AC 100V~240V(50.6Hz)	3.6Kw (220V basis)	7KHz~45KHz	280mm	Ø4~Ø16



ACCESSORIES

ACCESSORIES

Heating coil



Item	Model No.	Inner size
Heating coil	HEATING COIL-25MM	25mm
	HEATING COIL-30MM	30mm
	HEATING COIL-40MM	40mm
	HEATING COIL-55MM	55mm
Adapter flange	ST10,12,16,20,25,32	-

Adapter flange



Built-in product For separate-sale straight shank

※ Built-in Ø30 heating coil



CLEAN-TEC FAN

Cleaning Fan



Features

- Productivity improved as cleaning is possible without opening the CNC machine door
- The operator's safety improved as no compressed air is blown
- Electricity cost reduction due to a reduced use of compressed air
- Can be installed in ATC; production efficiency increased through automation equipment connection



Model No.	ØD(Unfolded)	Ø Shank	Max.RPM	Kg
Clean-Tec 160	160	20	12,000	0.2
Clean-Tec 260	260	20	8,000	0.2
Clean-Tec 330	330	20	8,000	0.5

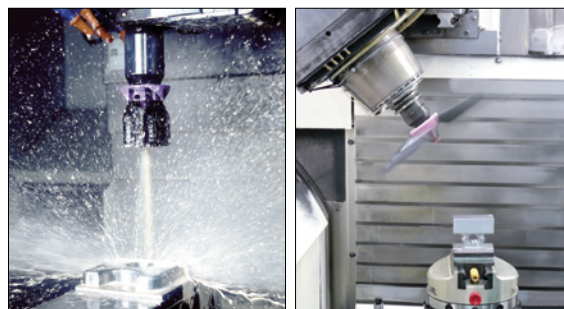


ACCESSORIES

ACCESSORIES



Usage related photo

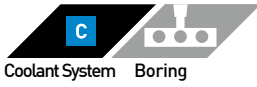


Model No.	Components	Compatible specifications
Spare Part Kit for Clean-Tec 160	4 wings / spring	Clean-Tec 160
Spare Part Kit for Clean-Tec 260		Clean-Tec 260
Spare Part Kit for Clean-Tec 330		Clean-Tec 330



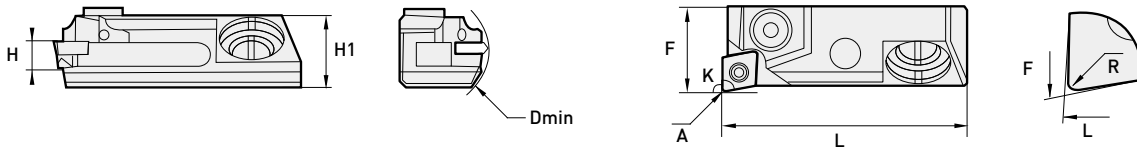
Precision micro adjusting cartridge

Precision micro adjusting cartridge



Features

- Both left-hand and right-hand versions available, internal coolant type
- Available minimum boring diameter: 28.00mm
- 90-degree, 95-degree lead angle versions
- Unit diameter adjustable up to 0.01mm within the radial adjustment 0.3mm (1 gradation adjustment radius: 0.005mm)
- Axial range adjustable: 1.0mm



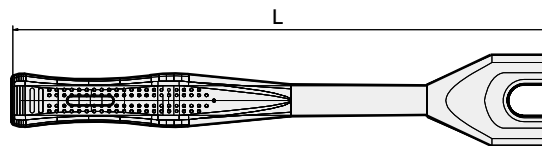
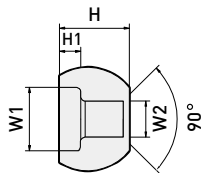
Model No.	K	H	F	L	H1	Dmin	R	Applicable insert
TMCR/L90-F16-CC06	90	8.8	16	45.8	13.5	28	0.4	CC..0602..
TMCR/L95-F16-CC06	95	8.8	16	45.8	13.5	28	0.4	CC..0602..
TMCR/L90-F16-TP09	90	8.8	16	45.8	13.5	28	0.4	TP..0902..
TMCR/L95-F16-TP09	95	8.8	16	45.8	13.5	28	0.4	TP..0902..
TMCR/L90-F20-TC11	90	8.8	20	45.8	13.5	36	0.4	TC..1102..
TMCR/L95-F20-TC11	95	8.8	20	45.8	13.5	36	0.4	TC..1102..
TMCR/L90-F20-TP11	90	8.8	20	45.8	13.5	36	0.4	TP..1103..
TMCR/L95-F20-TP11	95	8.8	20	45.8	13.5	36	0.4	TP..1103..



Pull stud bolt wrench

Pullstud bolt Wrench

Work fatigue reduced by using the pullstud bolt dedicated wrench



Model No.	L	H	H1	W1	W2	Torque	Kg	Application
PSBW-30	210	16	5	13	7.0	≤80	0.31	BT30
PSBW-40	230	25	6	19	10.0	≤150	0.43	BT40
PSBW-50	280	33	10	30	17.0	≤280	0.84	BT50
PSBW-40(PS-805)	230	20.5	7	19	14.0	≤150	0.43	JISB6339-B40
PSBW-40(PS-G51)	240	13	5	19	13.0	≤150	0.41	Mazak BT40
PSBW-50(PS-G41)	290	17	8	30	21.0	≤280	0.73	Mazak BT50

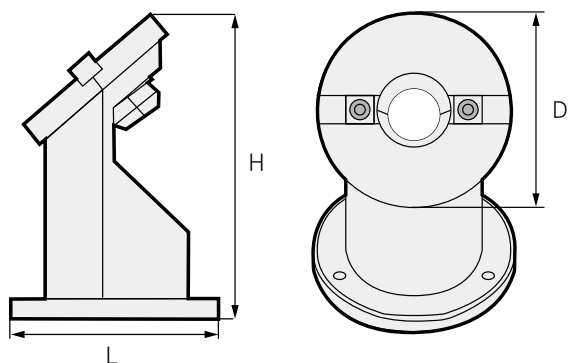


TOOL CLAMP

Tool CLAMP

Features

- For cutting tool and pullstud bolt tightening
- Enables more convenient and easier tightening in case of tool tightening using a 45-degree type
- Provides work stability by heavier load (3kg) than rival products



Model No.	Applicable shank	L	H	D	Kg
TTC30	BT30, NT30	119	169	114	3
TTC40	BT40, NT40				
TTC50	BT50, NT50				



MAGNETIC BASE

MAGNETIC BASE

Features

- Strong adsorptive power (80Kgf)
- Smooth and precise joint movement
- Ensures lightness and precision as a multi-joint model with a full aluminium body



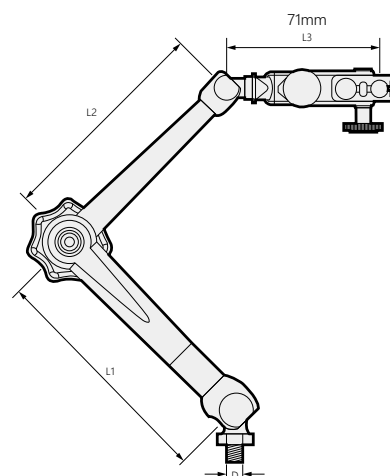
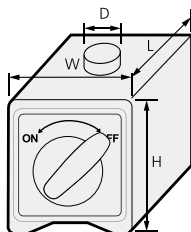
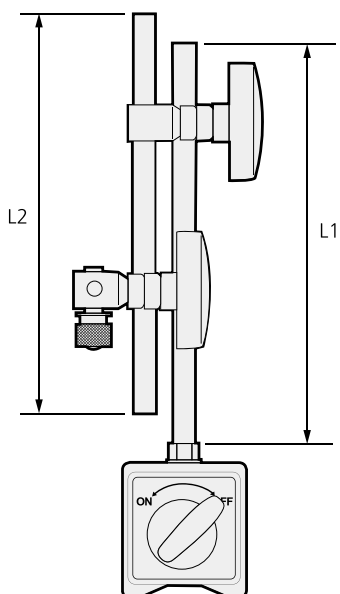
TMB-B



TMB-BV



TMB-330



Model No.	Type	Adsorptive power (Kgf)	L1	L2	L3	(L*W*H)	D	Weight (Kg)
TMB-B	160	80	170*Ø12	160*Ø10	-	60*50*55	M8*1.25	1.6
TMB-BV	260	80	170*Ø12	160*Ø10	-	60*50*55	M8*1.25	1.7
TMB-330	330	80	130*Ø12	130*Ø10	71	60*50*55	M8*1.25	1.5

※ For additional purchase of the base and TMB-B holder, please contact us.

Chuck

Arbor / Modular

Boring tool

Angular head

cBN/PCD

Smart factory

TAUMAX

OTHER

OTHER

DINOX NC TOOLING SYSTEM



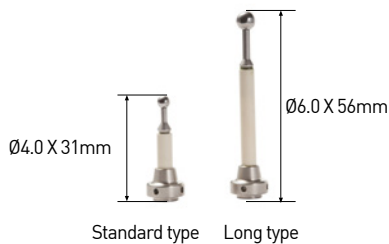
OTHER

DIGITAL 3D-TASTER	296
3D-TASTER 2007	296
HT HEIGHT TOUCH SETTER	297
DOP	297
DZH DINE Z AXIAL HEIGHT GAUGE	298
DZP DINE Z AXIAL SETTING HEIGHT GAUGE	298
DZOP DINE Z AXIAL P RESET GAUGE	299
HDG	299
ROT	300
NTSS NEW TOOL SETTING STAND	301
Shank specifications	302
Pull stud bolt	310
INDEX	312



DIGITAL 3D-TASTER

- High measurement accuracy: 0.01mm
- Display indication unit: 0.005mm
- Easy to check measured values through a highly visible display
- Omnidirectional movement and measurable stylus
- Highly waterproof and shockproof structure (IP65 class)
- Convenient and simple concentricity adjustment
- Compatible with conventional styluses
- -, + indicated according to movement direction based on zero reference
- Built-in CR2032 battery

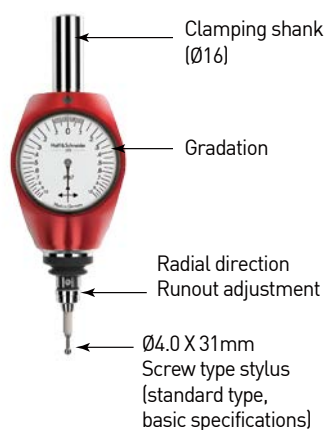
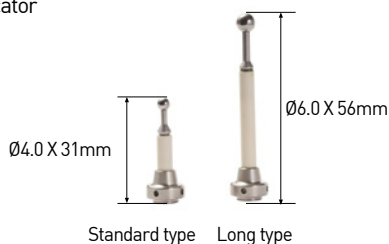


X,Y,Z axes Driving range	Measurement unit	Display range	Zero accuracy	Zero repetitive accuracy	Clamping shank	Battery classifications	Weight (g)
-2 / to 4mm	0.005mm (5µm)	±2mm	±0.01mm	±0.005mm	Ø16	CR2032	520



3D-TASTER 2007

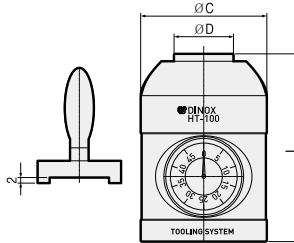
- High measurement accuracy: 0.01mm
- Easy zero adjustment
- Highly waterproof and vibration-proof structure (IP67 class)
- Screw-type stylus
Prevents the stylus from falling out by vibration and shock
- Simple and accurate radial run-out measurement
Radial run-out measured directly from the lower part of the scanning arm.
- Radial direction and axial direction measurable with one indicator



Measurement unit	Measurement precision	Clamping shank	Weight (g)
0.01mm	0.01mm	Ø16	397



HT HEIGHT TOUCH SETTER



Model No.	ØD	ØC	L
HT - 100	32	68	100

Features

- Enables the operator to easily sets up tool length at the CNC machining center
- Provides safe operation without interference between the height touch setter and tool
- Location precision : ±0.003mm



DOP DINE OPTICAL EDGE FINDER



Model No.	G.W.WEIGHT KGS	ACCURACY	LxWxH/UNIT:mm
DOP-20B	0.3kgs	±0.005	158X20X10

Features

- Long-time no rust as it is waterproof treated on the whole
- Note: An optical laser type cardiopulmonary system is not suitable for rotation applications.
- It sounds an alarm when touched.



DZH DINE Z AXIAL HEIGHT GAUGE



Model No.	HEIGHT	G.W.WEIGHT KGS	LxWxH/UNIT:mm
DZH-50	50.00±0.005mm	1.2kgs	50X63X63

Features

- For setting up the cutter length of MCT/Turning
- Design setting height: 50.00±0.005mm
- Wide plane face, easy operation
- Relatively less spring ejection and designed to prevent the milling cutter or bite from breaking
- Using a polished parallel plate enables an easy setting.
- Good parallelization degree, quick use response to each direction, and good accuracy
- Using a hexagonal wrench enables an easy adjustment of the height of the measuring stand.
- Using a hexagonal wrench enables an immediate zero (0) adjustment.
- Magnetic attachment type



DZP DINE Z AXIAL SETTING HEIGHT GAUGE



Model No.	HEIGHT	G.W.WEIGHT KGS	LxWxH/UNIT:mm
DZP-100	±0.005	0.73kgs	100X50X50

Features

- For setting the cutter length of MCT/turning
- Design setting height: 100.00±0.005mm
- Wide plane face, easy operation
- Magnetic attachment type
- Enables relatively less spring ejection; prevents the milling cutter or bite from breaking
- Using a polished parallel plate enables an easy setting.
- Good parallelization degree, quick use response to each direction, and good accuracy



DZOP DINE Z AXIAL P RESET GAUGE



Model No.	HEIGHT	G.W.WEIGHT KGS	LxWxH/UNIT:mm
DZOP-50	50	0.6kgs	50X53X53

Features

- For setting the cutter length of MCT/turning
- Design height : 50.00
- Wide plane face, easy operation
- Relatively less spring ejection and designed to prevent the milling cutter or bite from breaking
- Using a polished parallel plate enables an easy setting.
- Good parallelization degree, quick use response to each direction, and good accuracy
- It emits light when touched.
- Magnetic attached type



HDG Hydraulic expansion Chuck gauge



* The following standard is the standard for hydraulic expansion chuck sold by DINE. Therefore, for third-party products, measured values may be different.

Model No.	HEIGHT	G.W.WEIGHT KGS	LxWxH/UNIT:mm
HDG6	Ø6	16	80이상
HDG8	Ø8	23	80이상
HDG10	Ø10	45	110이상
HDG12	Ø12	90	120이상
HDG16	Ø16	185	150이상
HDG20	Ø20	330	160이상

Features

- Able to minimize the defect rate due to low clamping force than required
- A hydraulic expansion chuck gauge that can determine whether clamping force is appropriate before machining
- Can prevent defective machining caused by tool fallout



ROT

Run-out tester



Product Features

- Compatible with various shanks; provides diverse lineups
- Compliant with ISO30~ISO50 (ISO: BT,SK, NT,CAT) affordable general type and multi-type that can measure the cutting edge height and outer diameter simultaneously



Model No.

ROTS	ROTM
ROTS-ISO30	ROTM-ISO30
ROTS-ISO40	ROTM-ISO40
ROTS-ISO50	ROTM-ISO50

Description

Main component				Separate sale		
Shank	Body	Housing	Retainer	Test bar	arm	Indicator
ISO50	ROTM-BD	ROT-HS-ISO50	ROT-RTB-ISO50	BTN50-50-300	MB-1030-2	DIAL GAUGE (0.002mm)
ISO40	(Multi-type)	ROT-HS-ISO40	ROT-RTB-ISO40	BTN40-50-300		
	ROTS-BD	ROT-HS-ISO30	ROT-RTB-ISO30	BTN30-30-200		
ISO30	(General type)					

Simple measurements

Measure run-out easily by inserting and turn the tool



① After inserting the tool

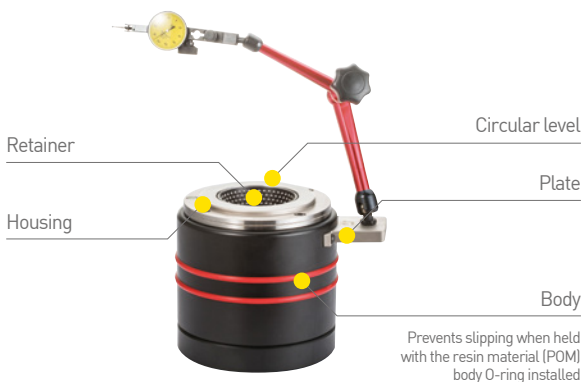
② Check R/O by turning the tool

Convenient horizontal adjustability

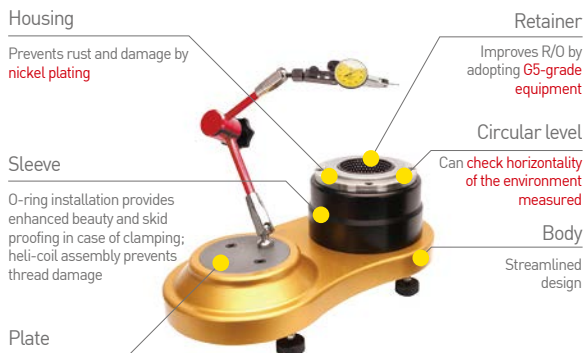


Can check horizontality by the level installed.

ROTS-General type (~Ø150)

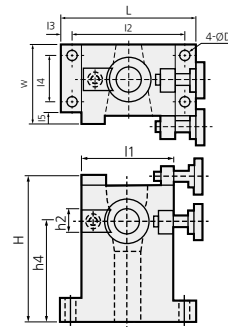


ROTM-Multi type (~Ø400)

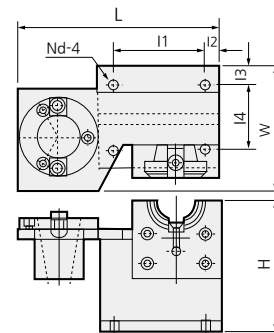




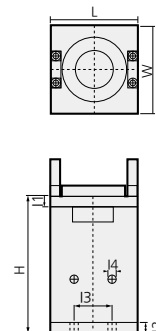
NTSS NEW TOOL SETTING STAND



Model No.	Type	L	I1	I2	I3	I4	H	W	G.W
NTSS-30	BT30	95	65	80	7.5	33	100	58	1kg
NTSS-40	BT40	118	77	99	9.2	44	130	75	1.7kg



Model No.	Type	L	I1	I2	I3	I4	H	W	G.W
NTSS-50	BT50	275	113	20	24	105	200	150	11.4kg

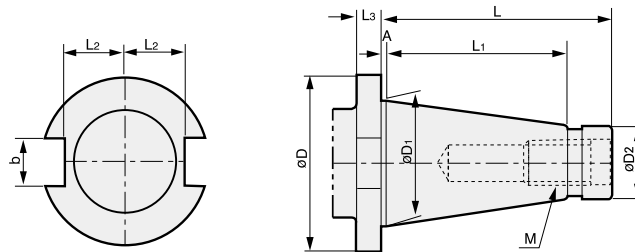


Model No.	Type	L	I1	I2	I3	I4	H	W	G.W
NTSS-HSK63A	HSK63A	106	11	11	50	9	160	106	4.1kg

Features

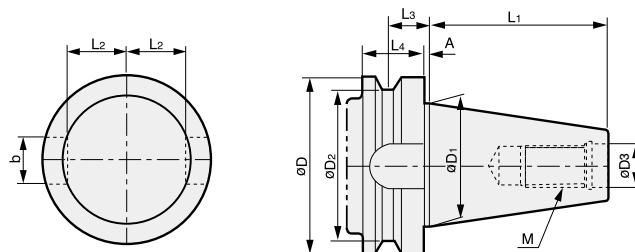
- Made of aluminium alloy
- Two types Vertical or Horizontal available All of BT, CAT, SK available

DIN 2080, JIS B 6101, ISO 297 : 1988(E)



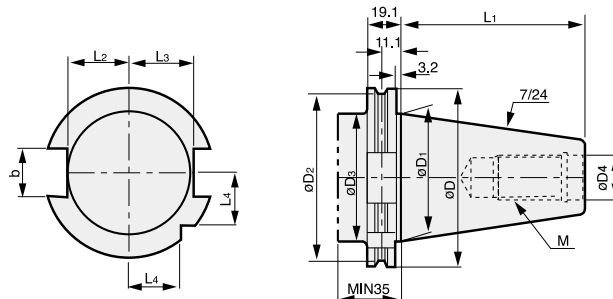
TAPER	ØD	ØD1	ØD2	L	L1	L2	L3	A	B	M
NT30	46	31.75	17.4	68.4	48.4	16.2	10	1.6	16.1	UNC 1/2-13
NT40	63	44.45	25.3	93.4	65.4	22.5	10	1.6	16.1	UNC 5/8 -11
NT50	100	69.85	39.6	126.8	101.8	35.3	14	3.2	25.7	UNC 1 - 8
NT60	155	107.95	60.2	206.8	161.8	60	15	3.2	25.7	UNC 1,1/4 -7

BOTTLE GRIP TAPER MAS403-BT



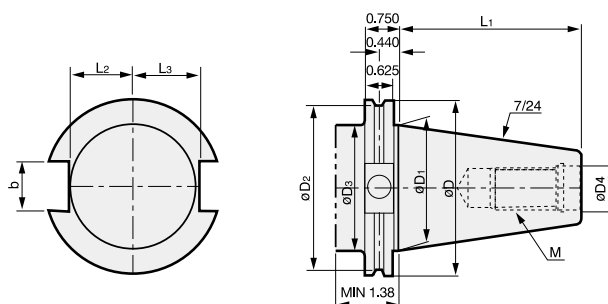
TAPER	ØD	ØD1	ØD2	ØD3	L1	L2	L3	L4	A	B	M
BT30	46	31.75	38	12.5	48.4	16.3	13.6	20	2	16.1	M12 x 1.75
BT40	63	44.45	53	17	65.4	22.6	16.6	25	2	16.1	M16 x 2
BT50	100	69.85	85	25	101.8	35.4	23.2	35	3	25.7	M24 x 3
BT60	155	107.95	135	31	161.8	60.1	28.2	45	3	25.7	M30 x 3.5

DIN 69871-1 A/B, ISO 7388/1 : 1983(E)



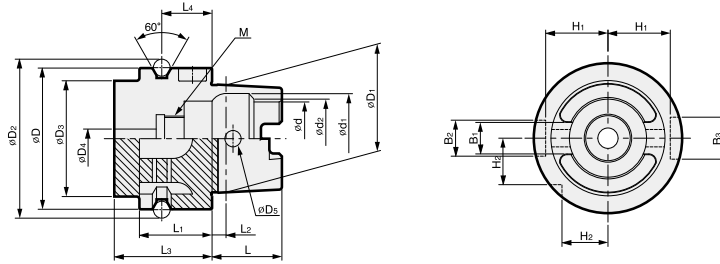
TAPER	ØD	ØD1	ØD2	ØD3	ØD4	L1	L2	L3	L4	B	M
SK30	50	31.75	44.3	45	13	47.8	16.4	19	15	16.1	M12 x 1.75
SK40	63.55	44.45	56.25	50	17	68.4	22.8	25	18.5	16.1	M16 x 2.0
SK50	97.5	69.85	91.25	80	25	101.75	35.5	37.7	30	25.7	M24 x 3.0

CAT SHANK (ANSI/ASME B5.50-1985)



TAPER	ØD	ØD1	ØD2	ØD3	ØD4	L1	L2	L3	B	M
CAT30	1.812	1.250	1.531	1.250	0.516	1.875	0.640	0.735	0.645	UNC 0.500-13
CAT40	2.500	1.750	2.219	1.750	0.641	2.687	0.890	0.985	0.645	UNC 0.625-11
CAT50	3.875	2.750	3.594	2.750	1.031	4.000	1.390	1.485	1.020	UNC 1.000-8
CAT60	5.500	4.250	5.219	4.250	1.281	6.375	2.140	2.235	1.020	UNC 1.250-7

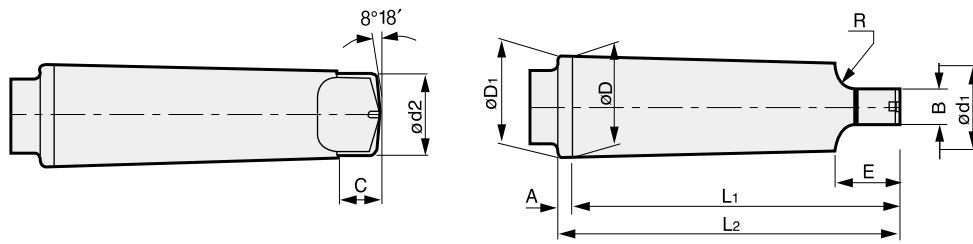
HSK SHANK DIN 69893-1, ISO 12164-1 : 2001



TAPER	ØD	ØD1	ØD3	ØD2	ØD4	ØD5	L	L1	L2	L3	L4
HSK 40A	40	30	34	45	5.0	4.6	20	20	4.0	35	16
HSK 50A	50	38	42	59.3	6.8	6.0	25	26	5.0	42	18
HSK 63A	63	48	53	72.3	8.4	7.5	32	26	6.3	42	18
HSK100A	100	75	88	109.75	12.0	12.0	50	29	10.0	45	20

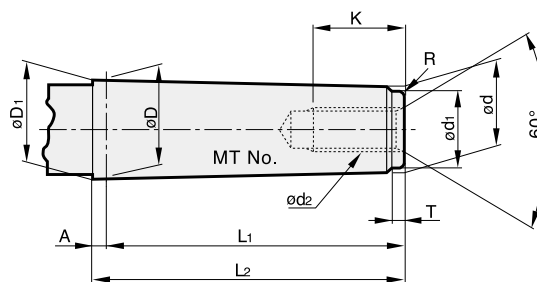
TAPER	Ød	Ød1	Ød2	B1	ØD4	ØD5	H1	H2	M
HSK 40A	21	25.5	23	8.05	11	9	17.0	12.0	M12×1.0
HSK 50A	26	32.0	29	10.54	14	12	21.0	15.5	M16×1.0
HSK 63A	34	40.0	37	12.54	18	16	26.5	20.0	M18×1.0
HSK 100A	53	63.0	58	20.02	22	20	44.0	31.5	M24×1.5

MORSE TAPER (TANG TYPE)



TAPER	Taper	Taper Angle(α)	$\varnothing D$	A	$\varnothing D1$	$\varnothing d1$	L1	L2	$\varnothing d2$	B	C	E	R	r
MT0	1/19.212	1°29'27"	9.045	3	9.201	6.104	56.5	59.5	6.0	3.9	6.5	10.5	4	1
MT1	1/20.047	1°25'43"	12.065	3.5	12.240	8.972	62.0	65.5	8.7	5.2	8.5	13.5	5	1.2
MT2	1/20.020	1°25'50"	17.780	5	18.030	14.034	75.0	80.0	13.5	6.3	10	16	6	1.6
MT3	1/19.922	1°26'16"	23.825	5	24.076	19.107	94.0	99.0	18.5	7.9	13	20	7	2
MT4	1/19.254	1°29'15"	31.267	6.5	31.605	25.164	117.5	124.0	24.5	11.9	16	24	8	2.5
MT5	1/19.002	1°30'26"	44.399	6.5	44.741	36.531	149.5	156.0	35.7	15.9	19	29	10	3
MT6	1/19.180	1°29'36"	63.348	8	63.765	52.399	210.0	218.0	51.0	19.0	27	40	13	4
MT7	1/19.231	1°29'22"	83.058	10	83.578	68.186	286.0	296.0	66.8	28.6	35	54	19	5

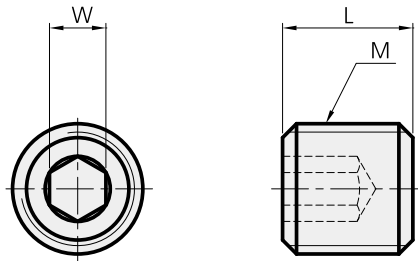
MORSE TAPER (SCREW TYPE)



TAPER	Taper	Taper Angle(α)	$\varnothing D$	A	$\varnothing D1$	d	L1	L2	$\varnothing d1$	d2	K	T	R
MT0	1/19.212	1°29'27"	9.045	3	9.201	6.442	50	53	6.4	-	-	4	0.2
MT1	1/20.047	1°25'43"	12.065	3.5	12.230	9.396	53.5	57	9.4	M6	16	5	0.2
MT2	1/20.020	1°25'50"	17.780	5	18.030	14.583	64	69	14.6	M10	24	5	0.2
MT3	1/19.922	1°26'16"	23.825	5	24.076	19.759	81	86	19.8	M12	28	7	0.6
MT4	1/19.254	1°29'15"	31.267	6.5	31.605	25.943	102.5	109	25.9	M16	32	9	1
MT5	1/19.002	1°30'26"	44.399	6.5	44.741	37.584	129.5	136	37.6	M20	40	9	2.5
MT6	1/19.180	1°29'36"	63.348	8	63.765	53.859	182	190	53.9	M24	50	12	4
MT7	1/19.231	1°29'22"	83.058	10	83.578	70.058	250	260	70.0	M33	80	18.5	5

SPARE PARTS

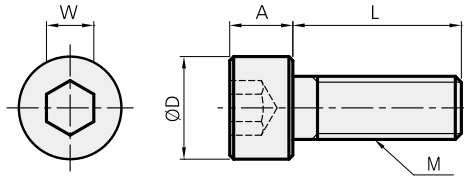
SET SCREW (BSA, BKA, FZ, FF, SLA, SMH)



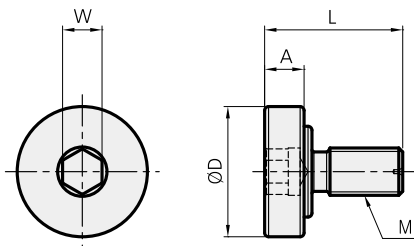
Model No.	M	L	W
BTF0505	M5x0.8	5	2.5
BTF0606	M6x10	6	3
BTF0608	M6x1.0	8	3
BTF0808	M8x1.25	8	4
BTF0812	M8x1.25	12	4
BTF1010	M10x1.5	10	5
BTF1012	M10x1.5	12	5
BTF1016	M10x1.5	16	5
BTF1060	M10x1.5	60	5
BTF1212	M12x1.75	12	6
BTF1212-1.5	M12x1.5	12	6
BTF1414-1.5	M14x1.5	14	6
BTF1216	M12x1.75	16	6
BTF1220	M12x1.75	20	6
BTF1225	M12x1.75	25	6
BTF1230	M12x1.75	30	6
BTF1616	M16x2.0	16	6
BTF1616-1.5	M16x1.5	16	8
BTF1624-1.5	M16x1.5	24	8
BTF1818-1.5	M18x1.5	18	8
BTF2020	M20x2.5	20	10
BTF2020-1.5	M20x1.5	20	10

SPARE PARTS

CLAMP BOLT (FMA, FMC, TBC, FBC, DBC)



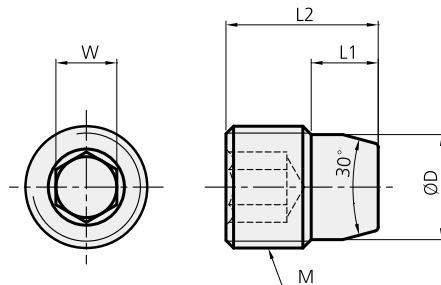
Model No.	M	A	L	ØD	W
BX0310	M3x0.5	3	10	5.5	2.5
BX0412	M4x0.7	4	12	7	3
BX0416	M4x0.7	4	16	7	3
BX0515	M5x0.8	5	15	8.5	4
BX0516	M5x0.8	5	16	8.5	4
BX0616	M6x1.0	6	16	10	5
BX0620	M6x1.0	6	20	10	5
BX0625	M6x1.0	6	25	10	5
BX0630	M6x1.0	6	30	10	5
BX0820	M8x1.25	8	20	13	6
BX0825	M8x1.25	8	25	13	6
BX0830	M8x1.25	8	30	13	6
BX1020	M10x1.5	8	20	16	8
BX1030	M10x1.5	8	30	16	8
BX1035	M10x1.5	8	35	16	8
BX1230	M12x1.75	12	30	18	10
BX1235	M12x1.75	12	35	18	10
BX1640	M16x2.0	16	40	24	14
BX1645	M16x2.0	16	45	24	14



Model No.	M	A	L	ØD	W
MBA-M8	M8x1.25	7	26	20	6
MBA-M10	M10x1.5	9	32	28	8
MBA-M12	M12x1.75	10	35	33	10
MBA-M16	M16x2.0	10	50	40	14
MBA-M20	M20x2.5	14	54	50	17
MBA-M24	M24x3.0	14	62	65	19

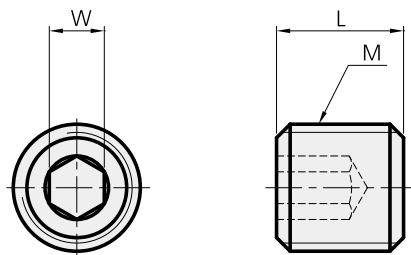
SPARE PARTS

TAPER SCREW (BASIC HOLDER) (SLA, FF, MD, EXT, RDC)



Model No.	M	L1	L2	ØD	W
BTT0506F	M5x0.5	2.8	5.5	4.1	2.5
BTT0608F	M6x0.75	3.8	8	4.9	3
BTT0810F	M8x0.75	4.8	10	6.9	4
BTT1013F	M10x1.0	5.75	13	8.5	5
BTT1215F	M12x1.0	6.8	16	10.5	6
BTT1620F	M16x1.5	8.8	20	13.8	8
BTT1626F	M16x1.5	10.75	26	13.8	8
BTT1631F	M16x1.5	10.75	31	13.8	8

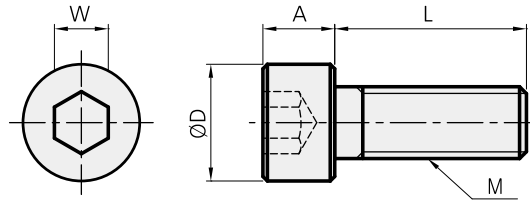
SET SCREW (TBC/FBC)



Model No.	M	L1	W
BT0645	M6x1.0	45	3
BT0660	M6x1.0	60	3

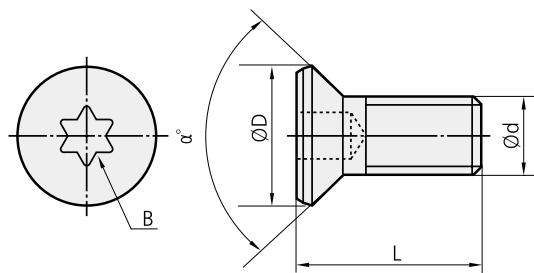
SPARE PARTS

CLAMP BOLT (FBB BITE)



Model No.	M	A	L	ØD	W
BXC0304	M3x0.5	2	5	5.5	2
BXC0405	M4x0.7	2.8	6	7	2.5
BXC0506	M5x0.8	3.5	6	8.5	3
BXC0610	M6x1.0	4	10	10	4
BXC0810	M8x1.25	5	10	13	5

INSERT SCREW



Model No.	M	L	ØD	B	α°	(N.m)
BFTX0203A	2x0.4	3.0	2.7	T6	90	0.5
BFTX0204A	2x0.4	4.3	2.7	T6	90	0.5
BFTX0307A	3x0.5	6.8	4.3	T10	90	2.0
BFTX0410A	4x0.7	10.3	5.6	T15	90	3.4
BFTX02506N	2.5x0.45	5.5	3.45	T8	60	1.5



Number o

□NU-CNGA□□□□□□	cBN/PCD	cBN Series	222
□NU-DNGA□□□□□□	cBN/PCD	cBN Series	222
□NU-VNGA□□□□□□	cBN/PCD	cBN Series	223
2NU-CCGW□□□□□□	cBN/PCD	cBN Series	223
2NU-DCGW□□□□□□	cBN/PCD	cBN Series	223
2NU-VBGW□□□□□□	cBN/PCD	cBN Series	224
2NU-VCGW□□□□□□	cBN/PCD	cBN Series	224
3D-TASTER 2007	Other	3D Taster	296
3NU-TCGW□□□□□□	cBN/PCD	cBN Series	223
3NU-TNGA□□□□□□	cBN/PCD	cBN Series	222
3NU-TPGB□□□□□□	cBN/PCD	cBN Series	224
3NU-TPGN□□□□□□	cBN/PCD	cBN Series	223
3NU-TPGW□□□□□□	cBN/PCD	cBN Series	223
4NS-CNGA□□□□□□	cBN/PCD	cBN Series	225
4NS-DNGA□□□□□□	cBN/PCD	cBN Series	225
4NU-SNGA□□□□□□	cBN/PCD	cBN Series	222

A

A SERIES	Smartfactory	A series collaborative robot	272
A0509	Smartfactory	A series collaborative robot (A0509)	274
A0912	Smartfactory	A series collaborative robot (A0912)	274
ANGULAR HEAD	Angular head	Angular head	198
ANTI STAIN PAINT	Smartfactory	Special paint treated	273

B

BB BITE	Boring tool	BB Bite (For SMB, SMH, KMB)	184
BCF	Boring tool	Micro boring bar	192
BH	Boring tool	Boring bite	185
BKA	Boring tool	FZ micro boring bar	188
BORING INSERT	Boring tool	Boring insert	191
BSA	Boring tool	Boring bar	186
BSA SPARE PART	Boring tool	Boring bar related parts	187

C

CAT SHANK	Other	CAT shank specifications	303
cBN List	cBN/PCD	cBN Series	222
cBN SERIES(Fiture)	cBN/PCD	cBN Series Features	228
cBN TECHNICAL DATA	cBN/PCD	cBN technical data	252
cBN(For Cast iron)	cBN/PCD	For cBN cast iron	238
cBN(For Heat treatment steel)	cBN/PCD	For cBN heat-treated steel	232
cBN(For Sintered metal)	cBN/PCD	For cBN sintered parts	240
CCMT□□□□□□	cBN/PCD	PCD Series	226
CCMW□□□□□□	cBN/PCD	cBN Series	224
CLEAN-TEC FAN	TAUMAX	Clean-Tec Fan	290
CLEAN-TEC FAN SPARE PART	TAUMAX	Clean-Tec Fan related parts	290
CNMA□□□□□□	cBN/PCD	cBN Series	224
CNMM□□□□□□	cBN/PCD	PCD Series	226
CNMW□□□□□□	cBN/PCD	PCD Series	226
COLLABORATIVE ROBOT	Smartfactory	Collaborative robot	272
CS/CM(2pieces type)	Chuck	shrinking chuck 2Piece type	50

D

DART PLATFORM	Smartfactory	Software that enables the control of the robot from a PC	273
DB1000	cBN/PCD	Uncoated cBN	248
DB2000	cBN/PCD	Uncoated cBN	249
DB7000	cBN/PCD	Uncoated cBN	250
DB7500	cBN/PCD	Uncoated cBN	251
DBC	Boring tool	Boring tool (rough-boring)	155
DBC SPARE PART	Boring tool	Balance cut tool related parts	158
DBC(Modular type)	Boring tool	Boring tool (modular type)	156
DBCA	Boring tool	Two-way controllable DBCA	144
DBCA SPARE PART	Boring tool	Two-way controllable DBCA related parts	158
DBCA(Helical type)	Boring tool	Two-way controllable DBCA (spiral shape)	146
DBCA(Straight type)	Boring tool	Two-way controllable DBCA(straight-line shape)	150

E



DC	Chuck	Straight collet	66
DCGT□□□□□□	cBN/PCD	PCD Series	226
DCGW□□□□□□	cBN/PCD	cBN Series	225
DCJ	Chuck	Jetcoolant collet for milling chuck	54
DCL	Chuck	Non-slip milling chuck collet	58
DCL SPARE PART	Chuck	Non-slip milling chuck collet related parts	62
DCMT□□□□□□	cBN/PCD	PCD Series	226
DCS	Chuck	Straight collet	64
DHC	Chuck	Hydraulic expansion chuck collet	32
DHE	Chuck	Hydraulic expansion chuck	27
DHE SPARE PART	Chuck	Hydraulic expansion chuck related parts	33
DHE/S	Chuck	Slim hydraulic expansion chuck	24
DHE/S SPARE PART	Chuck	Slim hydraulic expansion chuck related parts	26
DHJ	Chuck	Hydraulic expansion chuck jetcoolant collet	33
DIGITAL 3D-TASTER	Other	Digital 3D taster	296
DIN 2080, JIS B 6101, ISO 297 : 1988[E]	Other	NT shank specifications	302
DIN 69871-1 A/B, ISO 7388/1 : 1983[E]	Other	SK shank specifications	303
DIN 69893-1, ISO 12164-1 : 2001	Other	HSK shank specifications	304
DIRECT CONTROL UNIT-COCKPIT	Smartfactory	Direct teaching convenience option	273
DJT	Chuck	Drill chuck arbor	67
DNC100	cBN/PCD	Coated cBN	242
DNC250	cBN/PCD	Coated cBN	243
DNC300	cBN/PCD	Coated cBN	244
DNC350	cBN/PCD	Coated cBN	245
DNC400	cBN/PCD	Coated cBN	246
DNMA□□□□□□	cBN/PCD	cBN Series	224
DNMM□□□□□□	cBN/PCD	PCD Series	226
DOP	Other	Optical edge finder	297
DRESS PACK	Smartfactory	Harness arrangement package	273
DSC	Chuck	Shrinking chuck	36
DSC SPARE PART	Chuck	Shrinking chuck related parts	51
DSC/M(Mono curve type)	Chuck	Shrinking chuck mono curve type	43
DSC/M(Mono slim type)	Chuck	Shrinking chuck mono slim type	49
DSC/M(Mono type)	Chuck	Shrinking chuck mono type	44
DSC/M(Straight type)	Chuck	Shrinking chuck straight type	47
DSK	Chuck	Slim collet chuck	88
DSK SPARE PART	Chuck	Slim collet chuck related parts	91
DST[PAT.]	Chuck	High-speed tapping chuck	106
DTN	Chuck	Tapping chuck	102
DZC	Chuck	Zero fit collet	34
DZH	Other	Z axial height gauge	298
DZOP	Other	Z axial P reset gauge	299
DZP	Other	Z axial setting height gauge	298

F



ER COLLET	Chuck	ER collet	80
ER COLLET SET	Chuck	ER collet set	83
ER/L	Chuck	Non-slip collet chuck collet	84
EXT	Arbor/Modular	Extension bar	130

FBB BITE	Boring tool	Boring bite	143
FBC	Boring tool	Wide diameter boring for fine boring	171
FBC BITE	Boring tool	Boring bite	175
FBC SPARE PART	Boring tool	Wide diameter boring for fine boring related parts	174
FBH/B	Boring tool	Back boring balanced type	134
FBH/B SPARE PART	Boring tool	Micro boring balanced type related parts	142
FF	Boring tool	Micro boring unit	194
FF UNIT SPARE PART	Boring tool	FF unit related parts	194
FMA	Arbor/Modular	Face mill arbor	119
FMA SPARE PART	Arbor/Modular	Face mill arbor related parts	121
FMC	Arbor/Modular	Face mill arbor	122
FMC SPARE PART	Arbor/Modular	Face mill arbor related parts	125
FMD	Arbor/Modular	Basic holder	175
FT-SENSOR	Smartfactory	Precise force detection sensor	273



G	FZ UNIT	Boring tool	FZ Micro boring unit	190
	FZ UNIT SPARE PART	Boring tool	FZ unit related parts	191
	GERC	Chuck	GERC coating collet	75
	GERC COLLET SET	Chuck	GERC collet set	79
	GSK	Chuck	High-speed slim collet chuck	92
	GSK SPARE PART	Chuck	High-speed slim collet chuck related parts	97
	HC COLLET	Chuck	HC slim collet	98
	HDG	Other	Hydraulic expansion chuck gauge	299
	HRAG	Angular head	Rigidity-reinforced angular head (90° fixed type)	206
	HT	Other	Height touch setter	297
I	INSERT	Boring tool	FZ, FF unit insert	191
	INSERT CODE SYSTEM(ISO)	cBN/PCD	How to indicate the model no. of insert (ISO)	220
K	KAC	Angular head	Fixed angle-type angular head (45°)	212
	KAG	Angular head	Angular head (90° fixed type)	208
	KAH	Angular head	Collet-type angular head (90° fixed type)	210
	KHU	Angular head	Collet-type angular head (0°-90°)	204
	KMB	Boring tool	Micro boring	178
	KMB SPARE PART	Boring tool	Micro boring related parts	183
M	M SERIES	Smartfactory	M series collaborative robot	272
	M0609	Smartfactory	M series collaborative robot (M0609)	274
	M0617	Smartfactory	M series collaborative robot (M0617)	274
	M1013	Smartfactory	M series collaborative robot (M1013)	274
	M1509	Smartfactory	M series collaborative robot (M1509)	274
	MAGNETIC BASE	TAUMAX	Magnetic base	293
	MAH	Angular head	Rigidity-reinforced angular head	202
	MAS403-BT	Other	BT shank specifications	302
	MC MACHINE VISE-MVT-154	TAUMAX	Machine vise (standard type)	287
	MC POWER VISE-PVT	TAUMAX	Power vise (standard type)	284
	MC POWER VISE-PVTM	TAUMAX	Power vise (entry type)	285
	MD	Angular head	Modular arbor	126
	MD SPARE PART	Angular head	Modular arbor related parts	131
	MDM	Smartfactory	MDM software	270
	MH-200	TAUMAX	Shrink fit device	289
	MH-200 SPARE PART	TAUMAX	Shrink fit device related parts	289
	MOBILE BASE	Smartfactory	Robot controller	273
	MORSE TAPER(SCREW TYPE)	Other	Morse taper (screw type)	305
	MORSE TAPER(TANG TYPE)	Other	Morse taper (tang type)	305
	MTA	Arbor/Modular	Morse taper arbor	118
N	NOTCHED ENDMILL	Chuck	Notched end mill	63
	NPM	Chuck	New power milling chuck	52
	NPM SET	Chuck	New power milling chuck set	59
	NPM SPARE PART	Chuck	New power milling chuck related parts	61
	NPU	Chuck	Drill chuck	100
	NPU SPARE PART	Chuck	Drill chuck related parts	101
	NTSS	Other	Tool setting stand	301
	OFH	Chuck	Floating holder	110
P	PCD SERIES	cBN/PCD	PCD Series	226
	PCD TECHNICAL DATA	cBN/PCD	PCD technical data	261
	POSITIONING BLOCK	Angular head	Positioning block	214
	PRECISION MICRO ADJUSTING CARTRIDGE	TAUMAX	Precision boring adjusting cartridge	291
	PULLSTUD BOLT WRENCH	TAUMAX	Pullstud bolt wrench	291
	PULLSTUD BOLT	Other	Pullstud bolt	310

R

RA, GA CHIPBREAKER	cBN/PCD	RA, GA chip breaker	247
RDC	Arbor/Modular	Reducer bar	130
ROT	Other	Run-out tester	300
RTJW	Chuck	Jet coolant disk	86

S

SAH	Arbor/Modular	Slim angular head	201
SDC/P	Chuck	ER collet chuck	68
SDC/P SPARE PART	Chuck	ER collet chuck related parts	72
S-FBH/B	Boring tool	Micro boring balanced type	140
SLA	Arbor/Modular	Side lock arbor	114
SLA SPARE PART	Arbor/Modular	Side lock arbor related parts	117
SLK	Chuck	shrinking chuck 2 Piece type	51
SMART PENDANT	Smartfactory	Ultra-small pendant with necessary functions	273
SMART VISION MODULE	Smartfactory	Smart vision mobile	273
SMB	Boring tool	Small micro boring bar	176
SMB SPARE PART	Boring tool	Small micro boring bar related parts	183
SMH	Boring tool	Small micro boring bar(precision type)	180
SMH SET	Boring tool	Small micro boring set	182
SMH SPARE PART	Boring tool	Small micro boring bar(precision type) related parts	183
SPGN□□□□□□	cBN/PCD	PCD Series	227
S-SDC	Chuck	Collet chuck straight type	73

T

T-2NU-VBGW□□□□□□	cBN/PCD	cBN Series	224
T-□NU-VNGA□□□□□□	cBN/PCD	cBN Series	223
T-2NU-DCGW□□□□□□	cBN/PCD	cBN Series	223
T-2NU-VCGW□□□□□□	cBN/PCD	cBN Series	224
TAPER CLEANING DEVICE	TAUMAX	Taper cleaning device	288
TAPER CLEANING DEVICE SPARE PART	TAUMAX	Taper cleaning device related parts	288
TBC	Boring tool	Wide diameter boring for rough boring	166
TBC SPARE PART	Boring tool	Wide diameter boring for rough boring related parts	170
TBCA	Boring tool	Aluminium wide boring tool	160
TC	Chuck	Taper collet	65
TCA	Chuck	Tap adapter	105
T-CNMA□□□□□□	cBN/PCD	cBN Series	224
T-DCGW□□□□□□	cBN/PCD	cBN Series	225
TER	Chuck	ER tap collet	109
TNMA□□□□□□	cBN/PCD	cBN Series	224
TOOL CLAMP	TAUMAX	Tool clamp	292
TOOL MASTER	Smartfactory	Tool master	276
TOOL MASTER ADAPTER	Smartfactory	Tool master adapter	280
TOOL MASTER BASIC	Smartfactory	Tool master basic	278
TOOL MASTER LITE	Smartfactory	Tool master lite	277
TOOL MASTER QUADRA	Smartfactory	Tool master quadra	279
TPGB□□□□□□	cBN/PCD	cBN Series	225
TPGN□□□□□□	cBN/PCD	PCD Series	227
TPGW□□□□□□	cBN/PCD	PCD Series	227
T-TPGB□□□□□□	cBN/PCD	cBN Series	225
T-VNMA□□□□□□	cBN/PCD	cBN Series	224

U

UC CHIPBREAKER	cBN/PCD	UC chip breaker	264
----------------	---------	-----------------	-----

V

VBGW□□□□□□	cBN/PCD	PCD Series	227
VBMT□□□□□□	cBN/PCD	PCD Series	227
VBMW□□□□□□	cBN/PCD	cBN Series	225
VCMT□□□□□□	cBN/PCD	PCD Series	227
VNMA□□□□□□	cBN/PCD	cBN Series	224

W

WATER JACKET	Smartfactory	Pollution preventing jacket	273
--------------	--------------	-----------------------------	-----

Chuck

Arbor / Modular

Boring tool

Angular head

cBN/PCD

Smart factory

TAUMAX

OTHER



www.dinox.co.kr

Head Office [15118] 24, MTV 26-ro, Siheung-si, Gyeonggi-do, Korea | Tel. +82-31-488-6200 Fax +82-31-432-0583

Gyeongjin Branch	T. +82-31-432-0989	F. +82-31-435-1044	Jungbu Branch	T. +82-41-541-6688	F. +82-41-541-3553	Daegu Branch	T. +82-53-252-1441	F. +82-53-255-7176	
Nambu Branch	T. +82-51-831-3900	F. +82-51-831-3901	Nambu Support Center	T. +82-55-276-5533	F. +82-55-276-5534	Robot Division	T. +82-31-433-5060	F. +82-31-434-5060	
Marketing Team	T. +82-31-488-6242	F. +82-31-433-1721	Technical Support Team	T. +82-31-488-6250	F. +82-31-433-1723	Special Sale Team	T. +82-31-488-6281	F. +82-31-433-1721	
Branch Office in China	21F, Shandong Minyingkeji Building A, Shiling Road 39 Laoshan District, Qingdao City, China							T. +86-532-8588-5907	F. +86-532-8588-5082
Branch Office in Thailand	1/38 Bangna Thani Building 19B th Floor, Bangna-Trad 34 Alley, Bangna Tai Sub-district, Bangna District, Bangkok 10260							T. +66-02-108-8911-3	E. dine.thai@dine.co.kr
Branch Office in Vietnam	4th Floor, Tower B, Golden Palace Building, Me Tri ward, Nam Tu Liem district, Hanoi, Vietnam							T. +84-24-7300-6991	E. hoisukim3813@gmail.com

