

NEW



FM-LINE

VHM - Mikrofräser
Solid carbide micro end mills



Torusfräser Ø 0.2 - 6.0 mm
Schaftfräser Ø 0.2 - 3.0 mm und
Vollradiusfräser Ø 0.2 - 3.0 mm

Torus end mill Ø 0.2 - 6.0 mm
End mill Ø 0.2 - 3.0 mm und
Ball nose end mill Ø 0.2 - 3.0 mm

FM-LINE

VHM - Mikrofräser

solid carbide micro end mills

Übersicht

summary



Allgemeine Beschreibung

general instructions

... 4

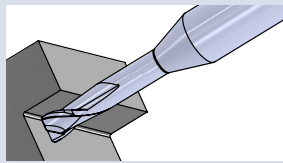

VHM - Mikrofräser

solid carbide
micro end mills

Maße
dimensions

Seite
page

Typ FMR ...

VHM - Mikro - Torusfräser
mit Radius

solid carbide micro torus end mill
with radius

Ø DS 0.2 - 6.0

... 6

Typ FMF ...

VHM - Mikro - Schaftfräser
mit Fase 45°

solid carbide micro end mill
with chamfer 45°

Ø DS 0.2 - 3.0

... 12

Typ FMVR

VHM - Mikro - Vollradiusfräser
(mit Vollradius)

solid carbide micro ball nose end mill
(with full radius)

Ø DS 0.2 - 3.0

... 17

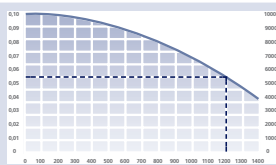

Technische Hinweise

Technical instructions

Seite
page

Schnittdaten

cutting data

... 22



FM-LINE

VHM - Mikrofräser

solid carbide micro end mills

Allgemeine Beschreibung

general instruction



FM-LINE:

Vollhartmetall Mikrofräser für den breiten Einsatz. Egal ob besäumen oder planfräsen, nutenfräsen oder 3D-Konturen abzeilen, diese Mikrofräser sind vielseitig einsetzbar.



Die FM-Line Werkzeuge sind in 3 Ausführungen ab Ø0.2 vorrätig. Als Torusfräser mit Radius bis Ø6, mit kleiner Fase bis Ø3 und als Vollradiusfräser bis Ø3.

FM-LINE:

Solid carbide micro end mills for a wide range of applications. Whether side or face milling, groove milling or 3D contours multipass milling, these micro end mills are versatile.

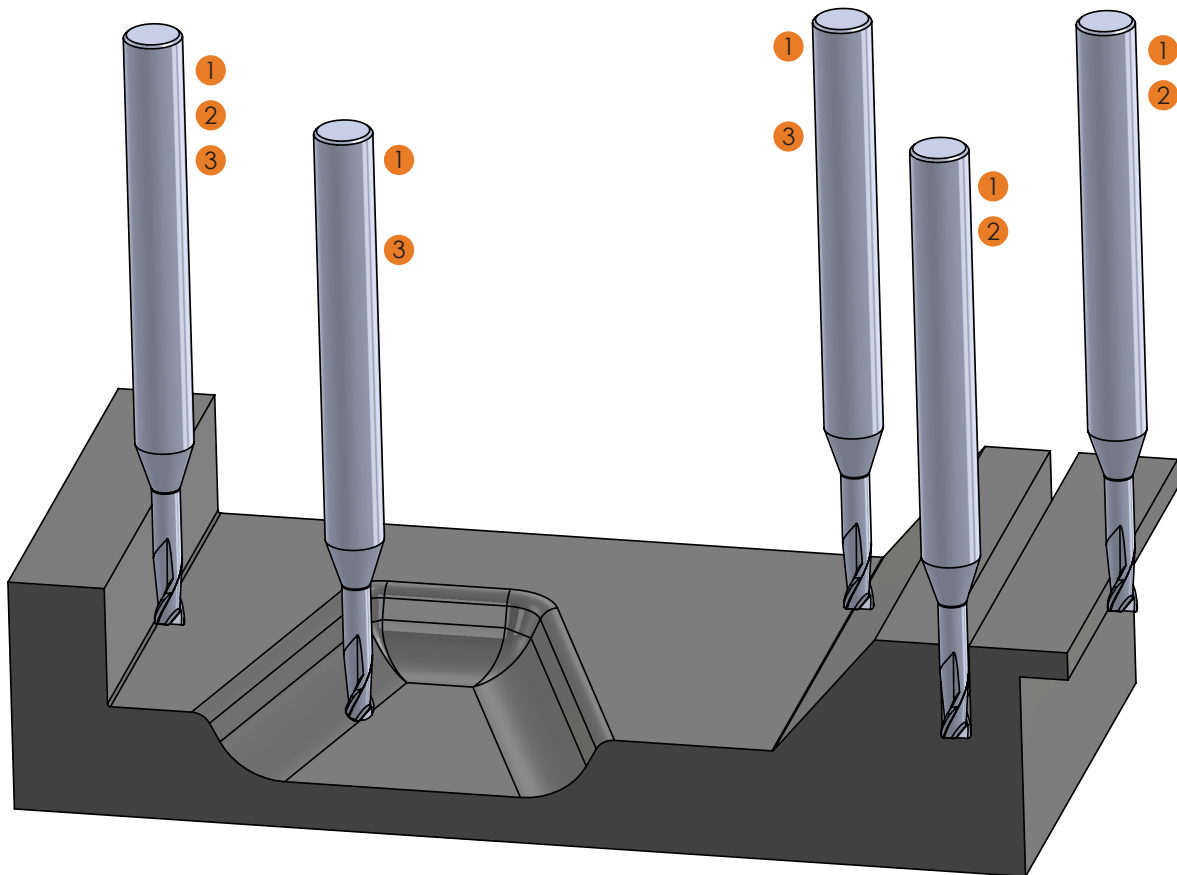
The FM-Line tools are available in 3 versions from Ø0.2. As a torus end mill with a radius up to Ø6, with a small chamfer up to Ø3 and as a full radius cutter up to Ø3.

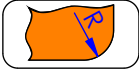
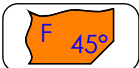

- 1  VHM - Mikro - Torusfräser mit Radius /
solid carbide micro torus end mill with radius
- 2  VHM - Mikro - Schaffräser mit Fase 45° /
solid carbide micro end mill with chamfer 45°
- 3  VHM - Mikro - Vollradiusfräser (mit Vollradius) /
solid carbide micro ball nose end mill (with full radius)

Anwendungsbeispiel
application example

Erklärung Symbole / Explanation of symbols

	<p>Anzahl Schneiden / number of cutting edges</p>
	<p>Schneidrichtung / cutting direction: 1) Besäumen / slicing 2) Rampe / ramping 3) Bohrfräsen / bore milling (helical milling)</p>
	<p>Schneidrichtung / cutting direction: 1) Besäumen / slicing 2) Rampe, Kontur oder 3D Fräsen / ramping, contour or 3D milling</p>
	<p>Rampe / ramping</p>
	<p>Helikalfräsen / helical milling</p>
	<p>Besäumen, Trochoidales Fräsen / slicing, trochoidal milling</p>
	<p>Stirnfräsen / face milling</p>
	<p>Vollnutfräsen / groove milling</p>
	<p>Kontur oder 3D Fräsen / contour or 3D milling</p>
	<p>Besäumen, Kontur / slicing, contour milling</p>



FM-LINE

VHM - Mikrofräser

solid carbide micro end mills

Typ FMR ...

VHM - Mikro - Torusfräser
mit Radius

solid carbide micro torus end mill
with radius

Fräser - Ø DS \triangleq 0.2 - 6.0 mm

mill - Ø DS \triangleq 0.2 - 6.0 mm

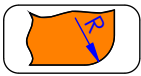
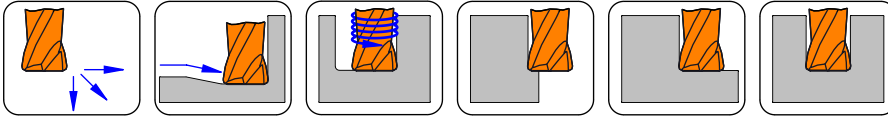

A

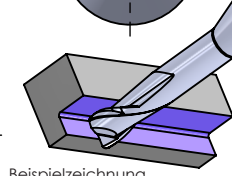
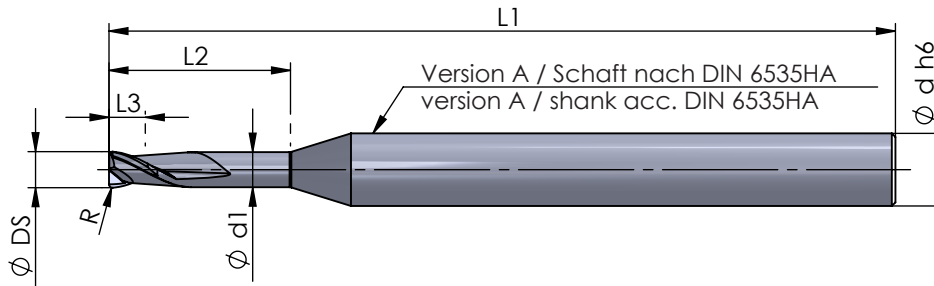

Beispielzeichnung
exemplary application

Schneidrichtung (R):
wie gezeichnet

cutting direction (R): as shown

Abmessungen in mm

dimensions in mm

Bestellnummer
part number

Ø DS

R

Ø d h6

Ø d1

L1

L2

L3

P04C

neu

FM0020.006.R02

0.2

0.02

6.0

0.18

55

0.6

0.2

●

neu

FM0020.010.R02

0.2

0.02

6.0

0.18

55

1.0

0.2

●

neu

FM0020.016.R02

0.2

0.02

6.0

0.18

55

1.6

0.5

●

neu

FM0020.020.R02

0.2

0.02

6.0

0.18

55

2.0

0.5

●

neu

FM0030.009.R03

0.3

0.03

6.0

0.28

55

0.9

0.5

●

neu

FM0030.015.R03

0.3

0.03

6.0

0.28

55

1.5

0.5

●

neu

FM0030.024.R03

0.3

0.03

6.0

0.28

55

2.4

1.2

●

neu

FM0030.030.R03

0.3

0.03

6.0

0.28

55

3.0

1.2

●

neu

FM0040.012.R04

0.4

0.04

6.0

0.37

55

1.2

0.5

●

neu

FM0040.020.R04

0.4

0.04

6.0

0.37

55

2.0

1.2

●

neu

FM0040.032.R04

0.4

0.04

6.0

0.37

55

3.2

1.2

●

neu

FM0040.040.R04

0.4

0.04

6.0

0.37

55

4.0

1.2

●

↳ ...

Bestellbeispiel:
für Sorte P04C:
FM0020.006.R02/P04C



order-example:
grade P04C:
FM0020.006.R02/P04C

FM-LINE

VHM - Mikrofräser

solid carbide micro end mills

Typ FMR ...

VHM - Mikro - Torusfräser mit Radius

solid carbide micro torus end mill with radius

Fräser - Ø DS \triangleq 0.2 - 6.0 mm

mill - Ø DS \triangleq 0.2 - 6.0 mm

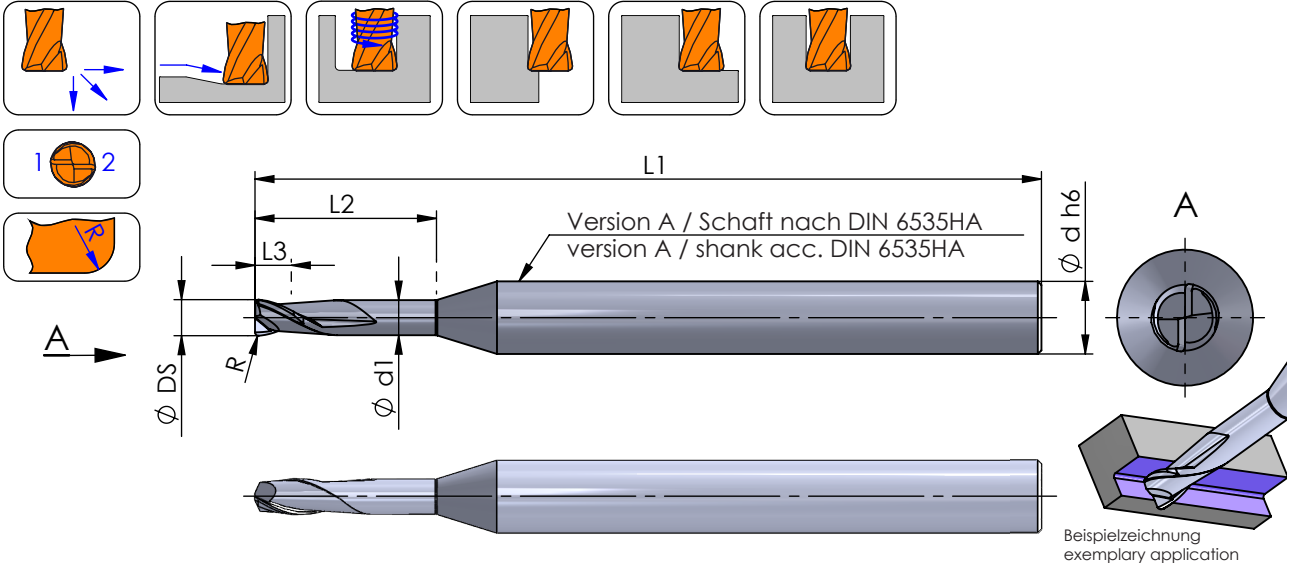

Schneidrichtung (R): wie gezeichnet

cutting direction (R): as shown

Abmessungen in mm

dimensions in mm

Bestellnummer part number	Ø DS	R	Ø d h6	Ø d1	L1	L2	L3	P04C
...								
neu FM0050.015.R05	0.5	0.05	6.0	0.45	55	1.5	0.5	●
neu FM0050.025.R05	0.5	0.05	6.0	0.45	55	2.5	1.2	●
neu FM0050.040.R05	0.5	0.05	6.0	0.45	55	4.0	1.2	●
neu FM0050.050.R05	0.5	0.05	6.0	0.45	55	5.0	1.2	●
neu FM0060.020.R06	0.6	0.06	6.0	0.58	55	2.0	1.2	●
neu FM0060.030.R06	0.6	0.06	6.0	0.58	55	3.0	1.2	●
neu FM0060.050.R06	0.6	0.06	6.0	0.58	65	5.0	1.2	●
neu FM0060.060.R06	0.6	0.06	6.0	0.58	65	6.0	1.2	●
neu FM0080.025.R08	0.8	0.08	6.0	0.77	55	2.5	1.2	●
neu FM0080.040.R08	0.8	0.08	6.0	0.77	55	4.0	1.2	●
neu FM0080.065.R08	0.8	0.08	6.0	0.77	65	6.5	1.2	●
neu FM0080.080.R08	0.8	0.08	6.0	0.77	65	8.0	1.2	●
↳ ...								

Bestellbeispiel:
für Sorte P04C:
FM0050.015.R05/P04C



order-example:
grade P04C:
FM0050.015.R05/P04C

FM-LINE

VHM - Mikrofräser

solid carbide micro end mills

Typ FMR ...

VHM - Mikro - Torusfräser
mit Radius

solid carbide micro torus end mill
with radius

Fräser - Ø DS \triangleq 0.2 - 6.0 mm

mill - Ø DS \triangleq 0.2 - 6.0 mm

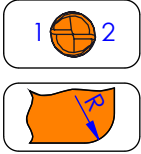
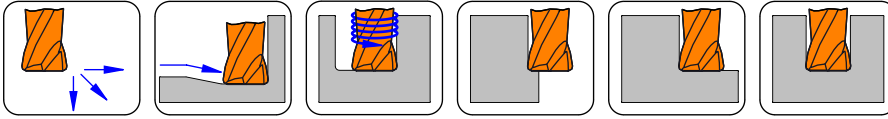

1 2

A

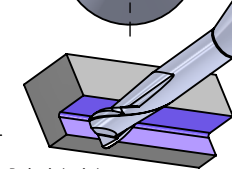
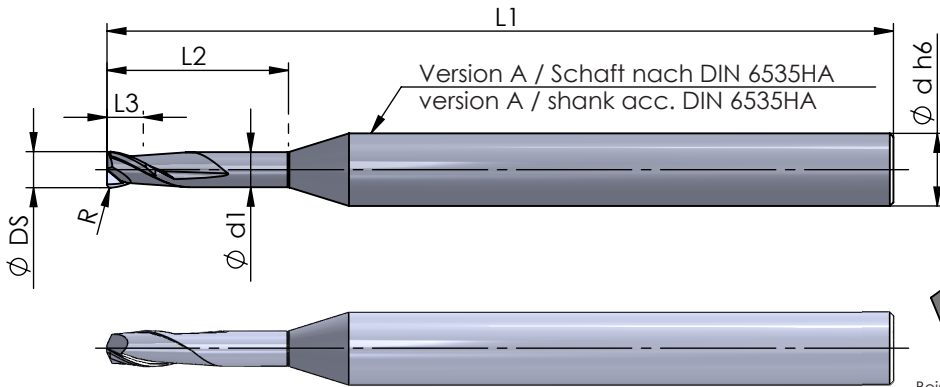

Beispielzeichnung
exemplary application

Schneidrichtung (R):
wie gezeichnet

cutting direction (R): as shown

Abmessungen in mm

dimensions in mm

Bestellnummer
part number

Ø DS

R

Ø d h6

Ø d1

L1

L2

L3

P04C

neu

FM0100.030.R10

1.0

0.10

6.0

0.95

55

3.0

1.5

●

neu

FM0100.050.R10

1.0

0.10

6.0

0.95

55

5.0

1.5

●

neu

FM0100.080.R10

1.0

0.10

6.0

0.95

65

8.0

1.5

●

neu

FM0100.100.R10

1.0

0.10

6.0

0.95

65

10.0

1.5

●

neu

FM0100.120.R10

1.0

0.10

6.0

0.95

65

12.0

1.5

●

neu

FM0120.030.R12

1.2

0.12

6.0

1.15

55

3.0

1.6

●

neu

FM0120.060.R12

1.2

0.12

6.0

1.15

55

6.0

1.6

●

neu

FM0120.100.R12

1.2

0.12

6.0

1.15

65

10.0

1.6

●

neu

FM0120.120.R12

1.2

0.12

6.0

1.15

65

12.0

1.6

●

neu

FM0130.040.R13

1.3

0.13

6.0

1.25

55

4.0

1.7

●

neu

FM0130.070.R13

1.3

0.13

6.0

1.25

55

7.0

1.7

●

neu

FM0130.110.R13

1.3

0.13

6.0

1.25

65

11.0

1.7

●

neu

FM0130.120.R13

1.3

0.13

6.0

1.25

65

12.0

1.7

●

neu

FM0130.130.R13

1.3

0.13

6.0

1.25

65

13.0

1.7

●

Bestellbeispiel:
für Sorte P04C:
FM0100.030.R10/P04C



order-example:
grade P04C:
FM0100.030.R10/P04C

FM-LINE

VHM - Mikrofräser

solid carbide micro end mills

Typ FMR ...

VHM - Mikro - Torusfräser mit Radius

solid carbide micro torus end mill with radius

Fräser - Ø DS \triangleq 0.2 - 6.0 mm

mill - Ø DS \triangleq 0.2 - 6.0 mm

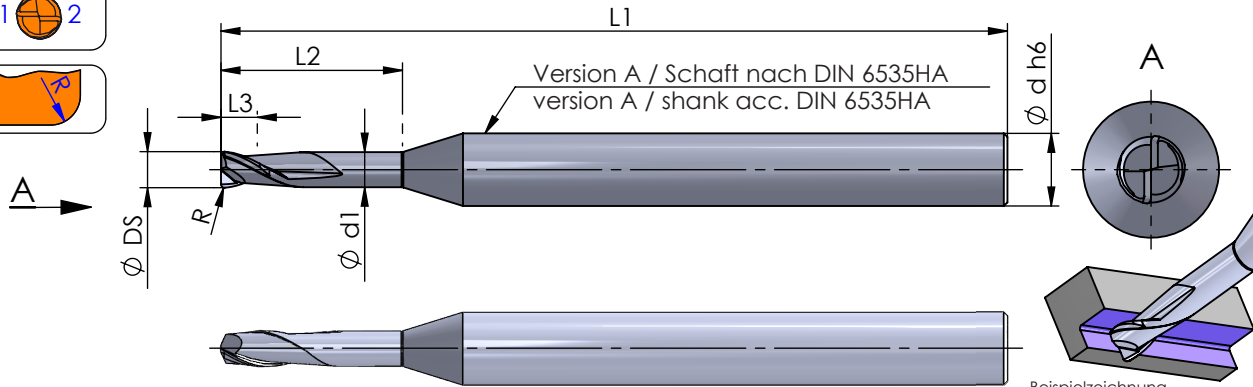
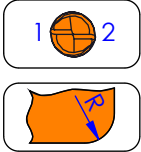
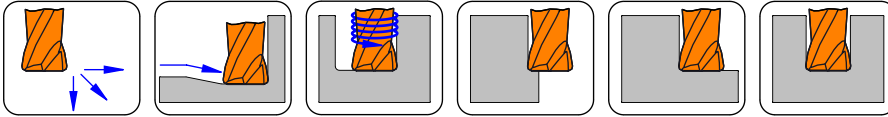

Schneidrichtung (R):
wie gezeichnet

cutting direction (R): as shown

Abmessungen in mm

dimensions in mm

Bestellnummer part number	Ø DS	R	Ø d h6	Ø d1	L1	L2	L3	P04C
...								
neu FM0150.050.R15	1.5	0.15	6.0	1.44	55	5.0	1.8	●
neu FM0150.075.R15	1.5	0.15	6.0	1.44	55	7.5	1.8	●
neu FM0150.120.R15	1.5	0.15	6.0	1.44	65	12.0	1.8	●
neu FM0150.150.R15	1.5	0.15	6.0	1.44	65	15.0	1.8	●
neu FM0160.050.R16	1.6	0.16	6.0	1.52	55	5.0	1.8	●
neu FM0160.080.R16	1.6	0.16	6.0	1.52	55	8.0	1.8	●
neu FM0160.130.R16	1.6	0.16	6.0	1.52	65	13.0	1.8	●
neu FM0160.160.R16	1.6	0.16	6.0	1.52	65	16.0	1.8	●
neu FM0180.055.R18	1.8	0.18	6.0	1.72	55	5.5	1.8	●
neu FM0180.090.R18	1.8	0.18	6.0	1.72	55	9.0	1.8	●
neu FM0180.145.R18	1.8	0.18	6.0	1.72	65	14.5	1.8	●
neu FM0180.180.R18	1.8	0.18	6.0	1.72	65	18.0	1.8	●
↳ ...								

Bestellbeispiel:
für Sorte P04C:
FM0150.050.R15/P04C



order-example:
grade P04C:
FM0150.050.R15/P04C

FM-LINE

VHM - Mikrofräser

solid carbide micro end mills

Typ FMR ...

VHM - Mikro - Torusfräser
mit Radius

solid carbide micro torus end mill
with radius

Fräser - Ø DS \triangleq 0.2 - 6.0 mm

mill - Ø DS \triangleq 0.2 - 6.0 mm

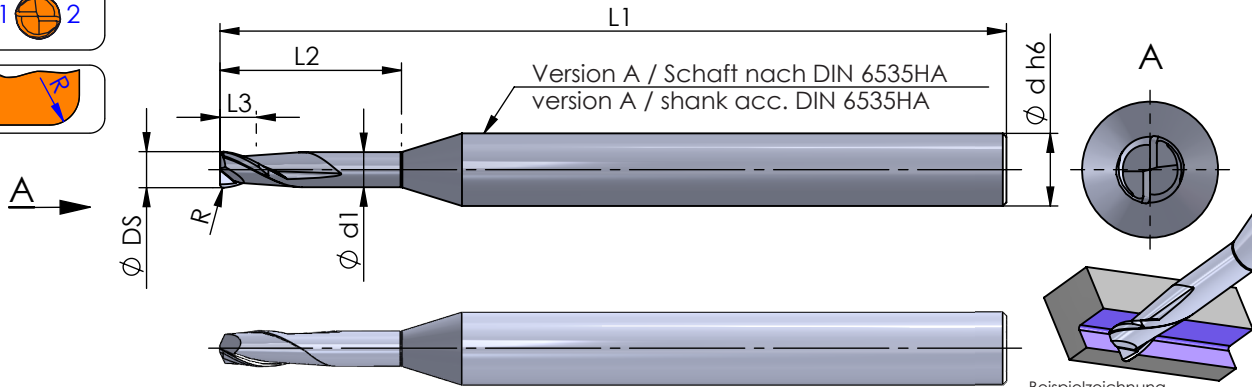
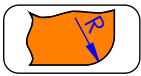
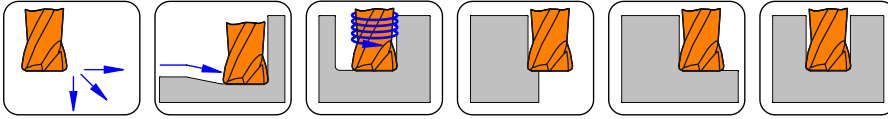

Beispielzeichnung
exemplary application

Schneidrichtung (R):
wie gezeichnet

cutting direction (R): as shown

Abmessungen in mm

dimensions in mm

Bestellnummer part number	Ø DS	R	Ø d h6	Ø d1	L1	L2	L3	P04C
...								
neu FM0200.060.R20	2.0	0.20	6.0	1.92	55	6.0	2.0	●
neu FM0200.100.R20	2.0	0.20	6.0	1.92	55	10.0	2.0	●
neu FM0200.140.R20	2.0	0.20	6.0	1.92	55	14.0	2.0	●
neu FM0200.160.R20	2.0	0.20	6.0	1.92	65	16.0	2.0	●
neu FM0200.200.R20	2.0	0.20	6.0	1.92	65	20.0	2.0	●
neu FM0230.070.R23	2.3	0.23	6.0	2.22	55	7.0	2.3	●
neu FM0230.115.R23	2.3	0.23	6.0	2.22	55	11.5	2.3	●
neu FM0230.185.R23	2.3	0.23	6.0	2.22	65	18.5	2.3	●
neu FM0230.200.R23	2.3	0.23	6.0	2.22	65	20.0	2.3	●
neu FM0230.230.R23	2.3	0.23	6.0	2.22	65	23.0	2.3	●
neu FM0300.090.R30	3.0	0.30	6.0	2.90	65	9.0	3.0	●
neu FM0300.150.R30	3.0	0.30	6.0	2.90	65	15.0	3.0	●
neu FM0300.240.R30	3.0	0.30	6.0	2.90	100	24.0	3.0	●
neu FM0300.300.R30	3.0	0.30	6.0	2.90	100	30.0	3.0	●
...								

Bestellbeispiel:
für Sorte P04C:
FM0200.060.R20/P04C



order-example:
grade P04C:
FM0200.060.R20/P04C

FM-LINE

VHM - Mikrofräser

solid carbide micro end mills

Typ FMR ...

VHM - Mikro - Torusfräser mit Radius

solid carbide micro torus end mill with radius

Fräser - Ø DS \triangleq 0.2 - 6.0 mm

mill - Ø DS \triangleq 0.2 - 6.0 mm

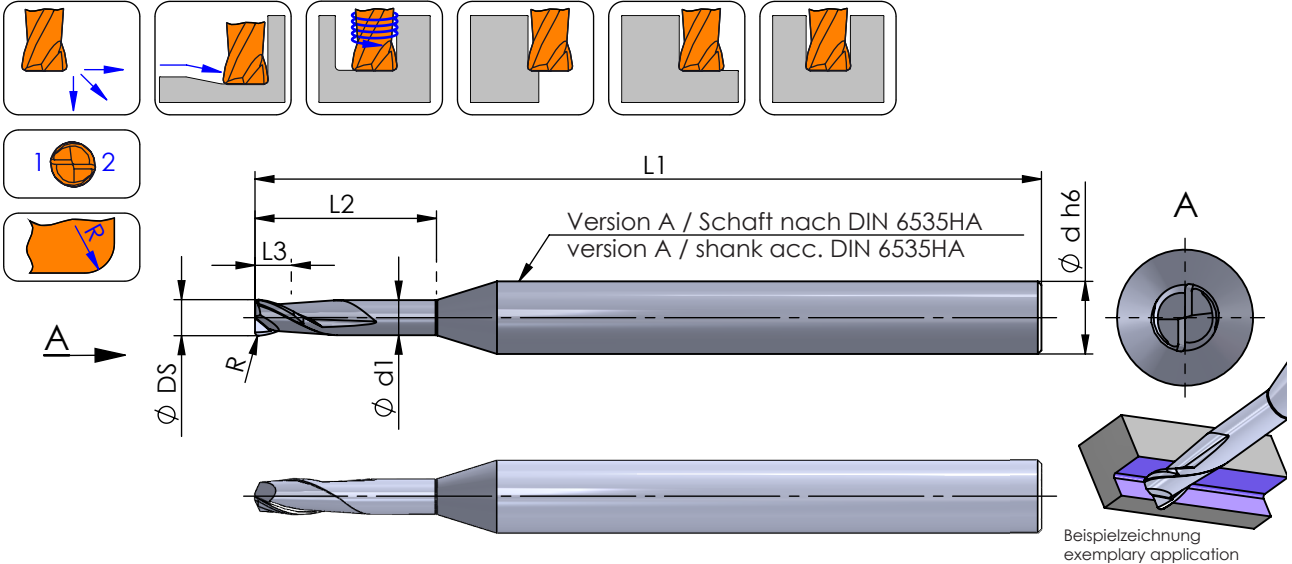

Schneidrichtung (R): wie gezeichnet

cutting direction (R): as shown

Abmessungen in mm

dimensions in mm

Bestellnummer part number	Ø DS	R	Ø d h6	Ø d1	L1	L2	L3	P04C
...								
neu FM0400.120.R40	4.0	0.40	6.0	3.90	65	12.0	4.0	●
neu FM0400.200.R40	4.0	0.40	6.0	3.90	65	20.0	4.0	●
neu FM0400.320.R40	4.0	0.40	6.0	3.90	100	32.0	4.0	●
neu FM0400.400.R40	4.0	0.40	6.0	3.90	100	40.0	4.0	●
neu FM0500.150.R50	5.0	0.50	6.0	4.90	65	15.0	5.0	●
neu FM0500.250.R50	5.0	0.50	6.0	4.90	65	25.0	5.0	●
neu FM0500.400.R50	5.0	0.50	6.0	4.90	100	40.0	5.0	●
neu FM0500.500.R50	5.0	0.50	6.0	4.90	100	50.0	5.0	●
neu FM0600.180.R60	6.0	0.60	6.0	5.90	65	18.0	6.0	●
neu FM0600.300.R60	6.0	0.60	6.0	5.90	100	30.0	6.0	●
neu FM0600.480.R60	6.0	0.60	6.0	5.90	100	48.0	6.0	●
neu FM0600.600.R60	6.0	0.60	6.0	5.90	100	60.0	6.0	●

Bestellbeispiel:
für Sorte P04C:
FM0400.120.R40/P04C



order-example:
grade P04C:
FM0400.120.R40/P04C

FM-LINE

VHM - Mikrofräser

solid carbide micro end mills

Typ FMF ...

VHM - Mikro - Schaftfräser
mit Fase 45°

solid carbide micro end mill
with chamfer 45°

Fräser - Ø DS \triangleq 0.2 - 3.0 mm

mill - Ø DS \triangleq 0.2 - 3.0 mm

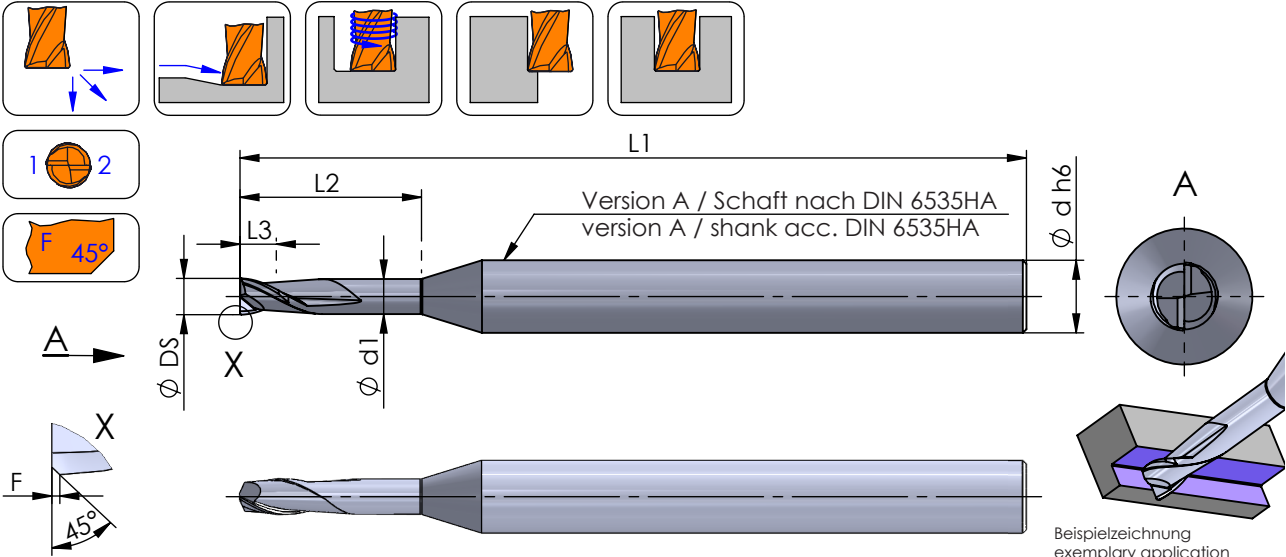

Schneidrichtung (R):
wie gezeichnet

cutting direction (R): as shown

Abmessungen in mm

dimensions in mm

Bestellnummer part number	Ø DS	F	Ø d h6	Ø d1	L1	L2	L3	P04C
neu FM0020.006.F02	0.2	0.02	6.0	0.18	55	0.6	0.2	●
neu FM0020.010.F02	0.2	0.02	6.0	0.18	55	1.0	0.2	●
neu FM0020.016.F02	0.2	0.02	6.0	0.18	55	1.6	0.5	●
neu FM0020.020.F02	0.2	0.02	6.0	0.18	55	2.0	0.5	●
neu FM0030.009.F03	0.3	0.03	6.0	0.28	55	0.9	0.5	●
neu FM0030.015.F03	0.3	0.03	6.0	0.28	55	1.5	0.5	●
neu FM0030.024.F03	0.3	0.03	6.0	0.28	55	2.4	1.2	●
neu FM0030.030.F03	0.3	0.03	6.0	0.28	55	3.0	1.2	●
neu FM0040.012.F04	0.4	0.04	6.0	0.37	55	1.2	0.5	●
neu FM0040.020.F04	0.4	0.04	6.0	0.37	55	2.0	1.2	●
neu FM0040.032.F04	0.4	0.04	6.0	0.37	55	3.2	1.2	●
neu FM0040.040.F04	0.4	0.04	6.0	0.37	55	4.0	1.2	●
↳ ...								

Bestellbeispiel:
für Sorte P04C:
FM0020.006.F02/P04C



order-example:
grade P04C:
FM0020.006.F02/P04C

FM-LINE

VHM - Mikrofräser

solid carbide micro end mills

Typ FMF ...

VHM - Mikro - Schaftfräser
mit Fase 45°

solid carbide micro end mill
with chamfer 45°

Fräser - Ø DS \triangleq 0.2 - 3.0 mm

mill - Ø DS \triangleq 0.2 - 3.0 mm

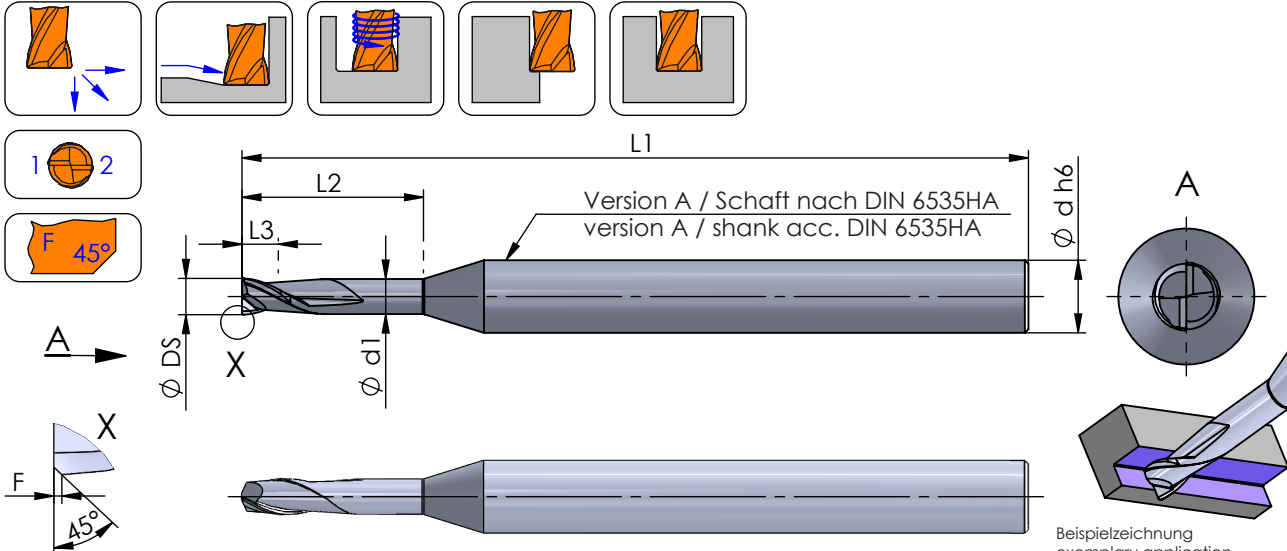

Schneidrichtung (R):
wie gezeichnet

cutting direction (R): as shown

Abmessungen in mm

dimensions in mm

Bestellnummer part number	Ø DS	F	Ø d h6	Ø d1	L1	L2	L3	P04C
... ↘								
neu FM0050.015.F05	0.5	0.05	6.0	0.45	55	1.5	0.5	●
neu FM0050.025.F05	0.5	0.05	6.0	0.45	55	2.5	1.2	●
neu FM0050.040.F05	0.5	0.05	6.0	0.45	55	4.0	1.2	●
neu FM0050.050.F05	0.5	0.05	6.0	0.45	55	5.0	1.2	●
neu FM0060.020.F06	0.6	0.06	6.0	0.58	55	2.0	1.2	●
neu FM0060.030.F06	0.6	0.06	6.0	0.58	55	3.0	1.2	●
neu FM0060.050.F06	0.6	0.06	6.0	0.58	65	5.0	1.2	●
neu FM0060.060.F06	0.6	0.06	6.0	0.58	65	6.0	1.2	●
neu FM0080.025.F08	0.8	0.08	6.0	0.77	55	2.5	1.2	●
neu FM0080.040.F08	0.8	0.08	6.0	0.77	55	4.0	1.2	●
neu FM0080.065.F08	0.8	0.08	6.0	0.77	65	6.5	1.2	●
neu FM0080.080.F08	0.8	0.08	6.0	0.77	65	8.0	1.2	●
↳ ...								

Bestellbeispiel:
für Sorte P04C:
FM0050.015.F05/P04C



order-example:
grade P04C:
FM0050.015.F05/P04C

FM-LINE

VHM - Mikrofräser

solid carbide micro end mills

Typ FMF ...

VHM - Mikro - Schaftfräser
mit Fase 45°

solid carbide micro end mill
with chamfer 45°

Fräser - Ø DS \triangleq 0.2 - 3.0 mm

mill - Ø DS \triangleq 0.2 - 3.0 mm

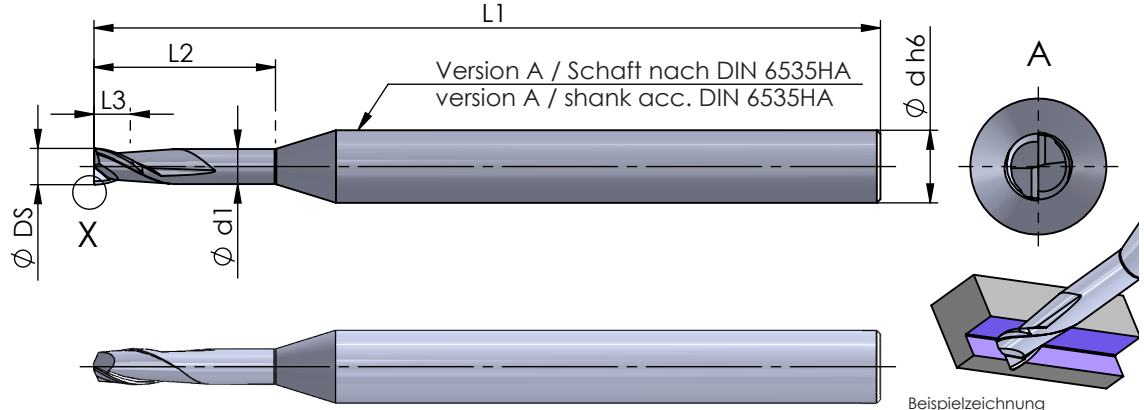
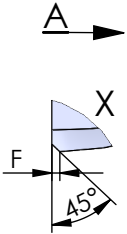
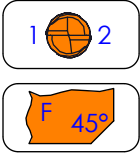
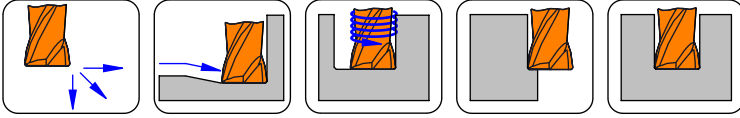

Beispielzeichnung
exemplary application

Schneidrichtung (R):
wie gezeichnet

cutting direction (R): as shown

Abmessungen in mm

dimensions in mm

Bestellnummer part number	Ø DS	F	Ø d h6	Ø d1	L1	L2	L3	P04C
... ↴								
neu FM0100.030.F10	1.0	0.10	6.0	0.95	55	3.0	1.5	●
neu FM0100.050.F10	1.0	0.10	6.0	0.95	55	5.0	1.5	●
neu FM0100.080.F10	1.0	0.10	6.0	0.95	65	8.0	1.5	●
neu FM0100.100.F10	1.0	0.10	6.0	0.95	65	10.0	1.5	●
neu FM0100.120.F10	1.0	0.10	6.0	0.95	65	12.0	1.5	●
neu FM0120.030.F10	1.2	0.10	6.0	1.15	55	3.0	1.6	●
neu FM0120.060.F10	1.2	0.10	6.0	1.15	55	6.0	1.6	●
neu FM0120.100.F10	1.2	0.10	6.0	1.15	65	10.0	1.6	●
neu FM0120.120.F10	1.2	0.10	6.0	1.15	65	12.0	1.6	●
neu FM0130.040.F10	1.3	0.10	6.0	1.25	55	4.0	1.7	●
neu FM0130.070.F10	1.3	0.10	6.0	1.25	55	7.0	1.7	●
neu FM0130.110.F10	1.3	0.10	6.0	1.25	65	11.0	1.7	●
neu FM0130.130.F10	1.3	0.10	6.0	1.25	65	13.0	1.7	●
↳ ...								

Bestellbeispiel:
für Sorte P04C:
FM0100.030.F10/P04C



order-example:
grade P04C:
FM0100.030.F10/P04C

FM-LINE

VHM - Mikrofräser

solid carbide micro end mills

Typ FMF ...

VHM - Mikro - Schaftfräser mit Fase 45°

solid carbide micro end mill with chamfer 45°

Fräser - Ø DS ≙ 0.2 - 3.0 mm

mill - Ø DS ≙ 0.2 - 3.0 mm

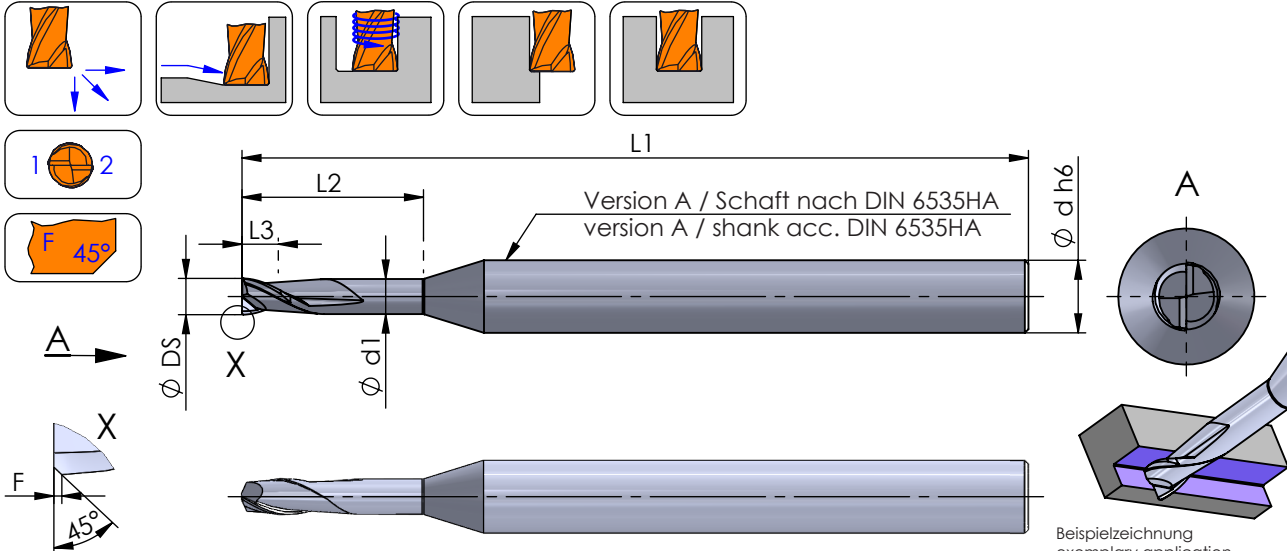

Schneidrichtung (R):
wie gezeichnet

cutting direction (R): as shown

Abmessungen in mm

dimensions in mm

Bestellnummer part number	Ø DS	F	Ø d h6	Ø d1	L1	L2	L3	P04C
... ↴								
neu FM0150.050.F10	1.5	0.10	6.0	1.44	55	5.0	1.8	●
neu FM0150.075.F10	1.5	0.10	6.0	1.44	55	7.5	1.8	●
neu FM0150.120.F10	1.5	0.10	6.0	1.44	65	12.0	1.8	●
neu FM0150.150.F10	1.5	0.10	6.0	1.44	65	15.0	1.8	●
neu FM0160.050.F10	1.6	0.10	6.0	1.52	55	5.0	1.8	●
neu FM0160.080.F10	1.6	0.10	6.0	1.52	55	8.0	1.8	●
neu FM0160.130.F10	1.6	0.10	6.0	1.52	65	13.0	1.8	●
neu FM0160.160.F10	1.6	0.10	6.0	1.52	65	16.0	1.8	●
neu FM0180.055.F10	1.8	0.10	6.0	1.72	55	5.5	1.8	●
neu FM0180.090.F10	1.8	0.10	6.0	1.72	55	9.0	1.8	●
neu FM0180.145.F10	1.8	0.10	6.0	1.72	65	14.5	1.8	●
neu FM0180.180.F10	1.8	0.10	6.0	1.72	65	18.0	1.8	●
↳ ...								

Bestellbeispiel:
für Sorte P04C:
FM0150.050.F10/P04C



order-example:
grade P04C:
FM0150.050.F10/P04C

FM-LINE

VHM - Mikrofräser

solid carbide micro end mills

Typ FMF ...

VHM - Mikro - Schaftfräser
mit Fase 45°

solid carbide micro end mill
with chamfer 45°

Fräser - Ø DS \triangleq 0.2 - 3.0 mm

mill - Ø DS \triangleq 0.2 - 3.0 mm

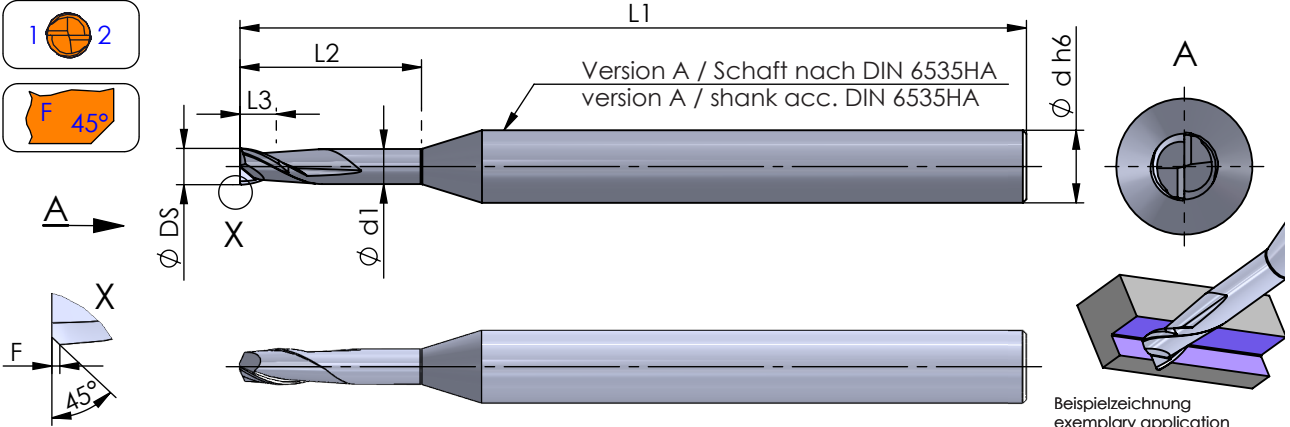
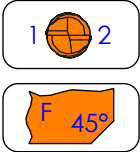
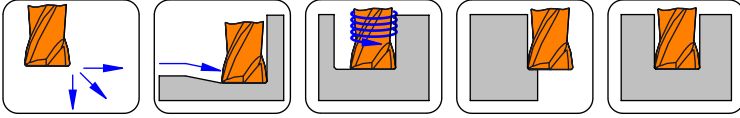

Schneidrichtung (R):
wie gezeichnet

cutting direction (R): as shown

Abmessungen in mm

dimensions in mm

Beispielzeichnung
exemplary application

Bestellnummer part number	Ø DS	F	Ø d h6	Ø d1	L1	L2	L3	P04C
... ↘								
neu FM0200.060.F10	2.0	0.10	6.0	1.92	55	6.0	2.0	●
neu FM0200.100.F10	2.0	0.10	6.0	1.92	55	10.0	2.0	●
neu FM0200.140.F10	2.0	0.10	6.0	1.92	55	14.0	2.0	●
neu FM0200.160.F10	2.0	0.10	6.0	1.92	65	16.0	2.0	●
neu FM0200.200.F10	2.0	0.10	6.0	1.92	65	20.0	2.0	●
neu FM0230.070.F10	2.3	0.10	6.0	2.22	55	7.0	2.3	●
neu FM0230.115.F10	2.3	0.10	6.0	2.22	55	11.5	2.3	●
neu FM0230.185.F10	2.3	0.10	6.0	2.22	65	18.5	2.3	●
neu FM0230.230.F10	2.3	0.10	6.0	2.22	65	23.0	2.3	●
neu FM0300.090.F10	3.0	0.10	6.0	2.90	65	9.0	3.0	●
neu FM0300.150.F10	3.0	0.10	6.0	2.90	65	15.0	3.0	●
neu FM0300.240.F10	3.0	0.10	6.0	2.90	100	24.0	3.0	●
neu FM0300.300.F10	3.0	0.10	6.0	2.90	100	30.0	3.0	●

Bestellbeispiel:
für Sorte P04C:
FM0200.060.F10/P04C



order-example:
grade P04C:
FM0200.060.F10/P04C

FM-LINE

VHM - Mikrofräser

solid carbide micro end mills

Typ FMVR ...

VHM - Mikro - Vollradiusfräser mit Radius

solid carbide micro ball nose end mill with radius

Fräser - Ø DS \triangleq 0.2 - 3.0 mm

mill - Ø DS \triangleq 0.2 - 3.0 mm

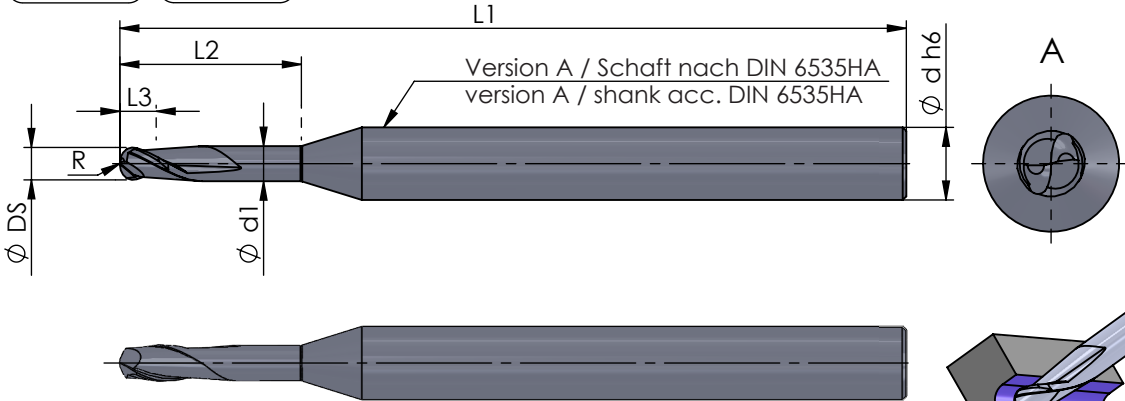
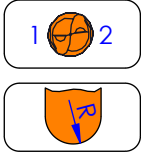
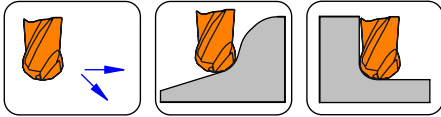

Beispielzeichnung
exemplary application

Schneidrichtung (R):
wie gezeichnet

cutting direction (R): as shown

Abmessungen in mm

dimensions in mm

Bestellnummer part number	Ø DS	R	Ø d h6	Ø d1	L1	L2	L3	P04C
neu FM0020.006.VR	0.2	0.10	6.0	0.18	55	0.6	0.2	●
neu FM0020.010.VR	0.2	0.10	6.0	0.18	55	1.0	0.2	●
neu FM0020.016.VR	0.2	0.10	6.0	0.18	55	1.6	0.5	●
neu FM0020.020.VR	0.2	0.10	6.0	0.18	55	2.0	0.5	●
neu FM0030.009.VR	0.3	0.15	6.0	0.28	55	0.9	0.5	●
neu FM0030.015.VR	0.3	0.15	6.0	0.28	55	1.5	0.5	●
neu FM0030.024.VR	0.3	0.15	6.0	0.28	55	2.4	1.2	●
neu FM0030.030.VR	0.3	0.15	6.0	0.28	55	3.0	1.2	●
neu FM0040.012.VR	0.4	0.20	6.0	0.37	55	1.2	0.5	●
neu FM0040.020.VR	0.4	0.20	6.0	0.37	55	2.0	1.2	●
neu FM0040.032.VR	0.4	0.20	6.0	0.37	55	3.2	1.2	●
neu FM0040.040.VR	0.4	0.20	6.0	0.37	55	4.0	1.2	●
↳ ...								

Bestellbeispiel:
für Sorte P04C:
FM0020.006.VR/P04C



order-example:
grade P04C:
FM0020.006.VR/P04C

FM-LINE

VHM - Mikrofräser

solid carbide micro end mills

Typ FMVR ...

VHM - Mikro - Vollradiusfräser
mit Radius

solid carbide micro ball nose end mill
with radius

Fräser - Ø DS \triangleq 0.2 - 3.0 mm

mill - Ø DS \triangleq 0.2 - 3.0 mm

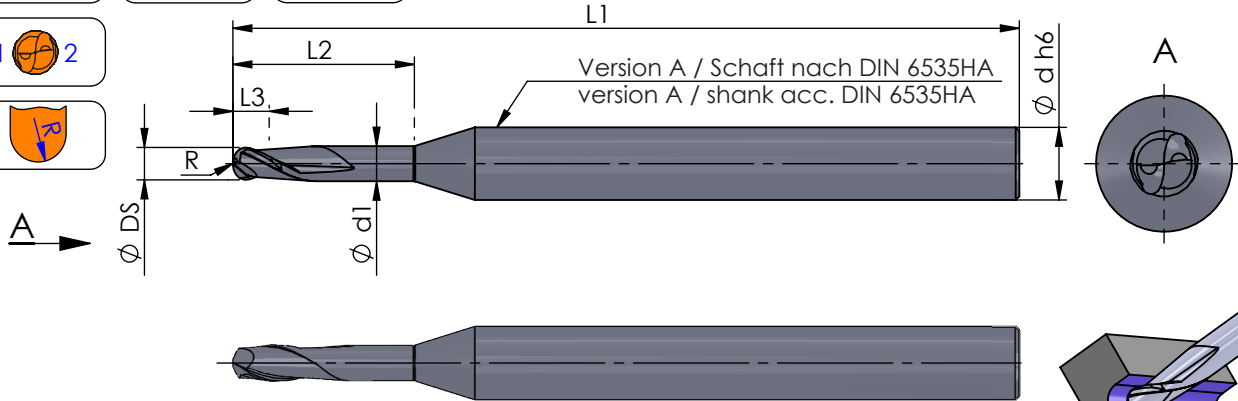
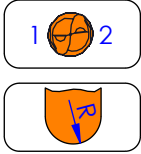
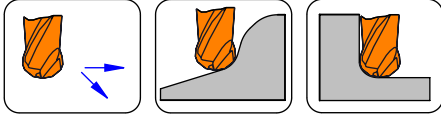

Beispielzeichnung
exemplary application

Schneidrichtung (R):
wie gezeichnet

cutting direction (R): as shown

Abmessungen in mm

dimensions in mm

Bestellnummer part number	Ø DS	R	Ø d h6	Ø d1	L1	L2	L3	P04C
... ↴								
neu FM0050.015.VR	0.5	0.25	6.0	0.45	55	1.5	0.5	●
neu FM0050.025.VR	0.5	0.25	6.0	0.45	55	2.5	1.2	●
neu FM0050.040.VR	0.5	0.25	6.0	0.45	55	4.0	1.2	●
neu FM0050.050.VR	0.5	0.25	6.0	0.45	55	5.0	1.2	●
neu FM0060.020.VR	0.6	0.30	6.0	0.58	55	2.0	1.2	●
neu FM0060.030.VR	0.6	0.30	6.0	0.58	55	3.0	1.2	●
neu FM0060.050.VR	0.6	0.30	6.0	0.58	65	5.0	1.2	●
neu FM0060.060.VR	0.6	0.30	6.0	0.58	65	6.0	1.2	●
neu FM0080.025.VR	0.8	0.40	6.0	0.77	55	2.5	1.2	●
neu FM0080.040.VR	0.8	0.40	6.0	0.77	55	4.0	1.2	●
neu FM0080.065.VR	0.8	0.40	6.0	0.77	65	6.5	1.2	●
neu FM0080.080.VR	0.8	0.40	6.0	0.77	65	8.0	1.2	●
↳ ...								

Bestellbeispiel:
für Sorte P04C:
FM0050.015.VR/P04C



order-example:
grade P04C:
FM0050.015.VR/P04C

FM-LINE

VHM - Mikrofräser

solid carbide micro end mills

Typ FMVR ...

VHM - Mikro - Vollradiusfräser mit Radius

solid carbide micro ball nose end mill with radius

Fräser - Ø DS \triangleq 0.2 - 3.0 mm

mill - Ø DS \triangleq 0.2 - 3.0 mm

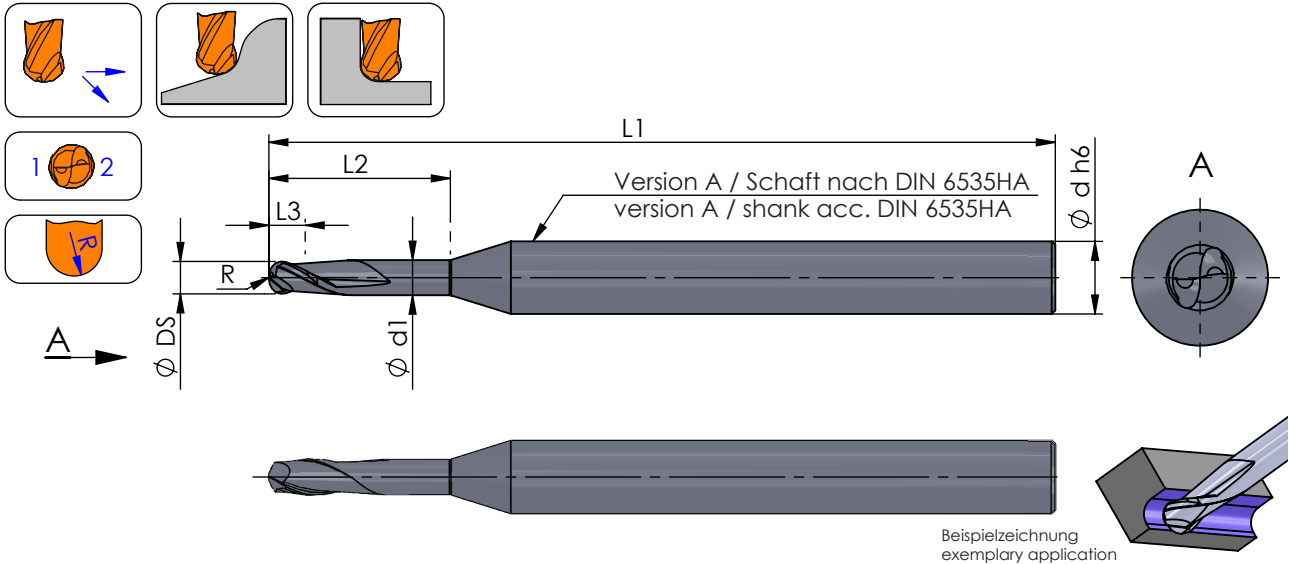

Schneidrichtung (R): wie gezeichnet

cutting direction (R): as shown

Abmessungen in mm

dimensions in mm

Bestellnummer part number	Ø DS	R	Ø d h6	Ø d1	L1	L2	L3	P04C
...								
neu FM0100.030.VR	1.0	0.50	6.0	0.95	55	3.0	1.5	●
neu FM0100.050.VR	1.0	0.50	6.0	0.95	55	5.0	1.5	●
neu FM0100.080.VR	1.0	0.50	6.0	0.95	65	8.0	1.5	●
neu FM0100.100.VR	1.0	0.50	6.0	0.95	65	10.0	1.5	●
neu FM0100.120.VR	1.0	0.50	6.0	0.95	65	12.0	1.5	●
neu FM0120.030.VR	1.2	0.60	6.0	1.15	55	3.0	1.6	●
neu FM0120.060.VR	1.2	0.60	6.0	1.15	55	6.0	1.6	●
neu FM0120.100.VR	1.2	0.60	6.0	1.15	65	10.0	1.6	●
neu FM0120.120.VR	1.2	0.60	6.0	1.15	65	12.0	1.6	●
neu FM0130.040.VR	1.3	0.65	6.0	1.25	55	4.0	1.7	●
neu FM0130.070.VR	1.3	0.65	6.0	1.25	55	7.0	1.7	●
neu FM0130.110.VR	1.3	0.65	6.0	1.25	65	11.0	1.7	●
neu FM0130.120.VR	1.3	0.65	6.0	1.25	65	12.0	1.7	●
neu FM0130.130.VR	1.3	0.65	6.0	1.25	65	13.0	1.7	●
↳ ...								

Bestellbeispiel:
für Sorte P04C:
FM0100.030.VR/P04C



order-example:
grade P04C:
FM0100.030.VR/P04C

FM-LINE

VHM - Mikrofräser

solid carbide micro end mills

Typ FMVR ...

VHM - Mikro - Vollradiusfräser
mit Radius

solid carbide micro ball nose end mill
with radius

Fräser - Ø DS \triangleq 0.2 - 3.0 mm

mill - Ø DS \triangleq 0.2 - 3.0 mm

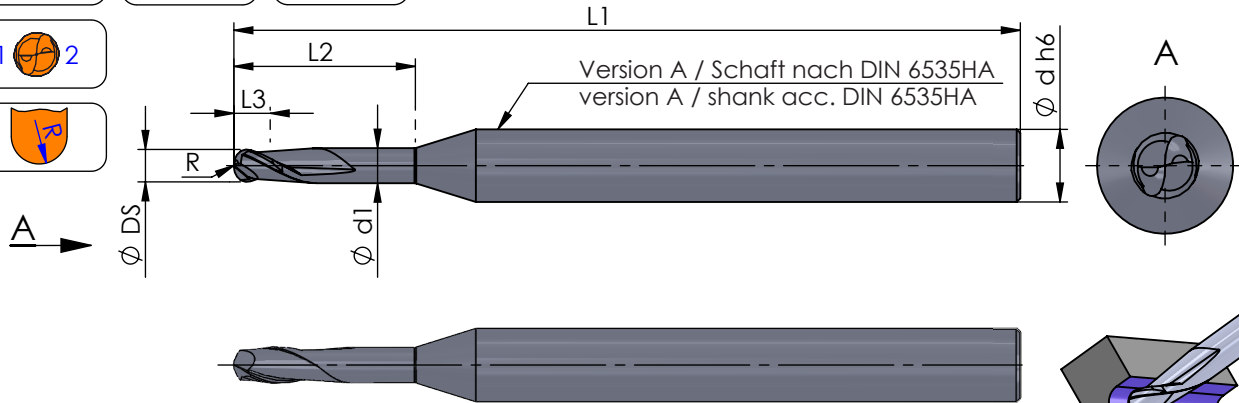
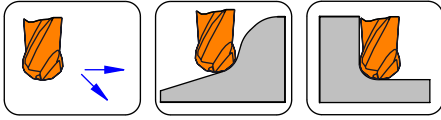

Beispielzeichnung
exemplary application

Schneidrichtung (R):
wie gezeichnet

cutting direction (R): as shown

Abmessungen in mm

dimensions in mm

Bestellnummer
part number

Ø DS

R

Ø d h6

Ø d1

L1

L2

L3

P04C

neu

FM0150.050.VR

1.5

0.75

6.0

1.44

55

5.0

1.8

●

neu

FM0150.075.VR

1.5

0.75

6.0

1.44

55

7.5

1.8

●

neu

FM0150.120.VR

1.5

0.75

6.0

1.44

65

12.0

1.8

●

neu

FM0150.150.VR

1.5

0.75

6.0

1.44

65

15.0

1.8

●

neu

FM0160.050.VR

1.6

0.80

6.0

1.52

55

5.0

1.8

●

neu

FM0160.080.VR

1.6

0.80

6.0

1.52

55

8.0

1.8

●

neu

FM0160.130.VR

1.6

0.80

6.0

1.52

65

13.0

1.8

●

neu

FM0160.160.VR

1.6

0.80

6.0

1.52

65

16.0

1.8

●

neu

FM0180.055.VR

1.8

0.90

6.0

1.72

55

5.5

1.8

●

neu

FM0180.090.VR

1.8

0.90

6.0

1.72

55

9.0

1.8

●

neu

FM0180.145.VR

1.8

0.90

6.0

1.72

65

14.5

1.8

●

neu

FM0180.180.VR

1.8

0.90

6.0

1.72

65

18.0

1.8

●

↳ ...

Bestellbeispiel:
für Sorte P04C:
FM0150.050.VR/P04C



order-example:
grade P04C:
FM0150.050.VR/P04C

FM-LINE

VHM - Mikrofräser

solid carbide micro end mills

Typ FMVR ...

VHM - Mikro - Vollradiusfräser mit Radius

solid carbide micro ball nose end mill with radius

Fräser - Ø DS \triangleq 0.2 - 3.0 mm

mill - Ø DS \triangleq 0.2 - 3.0 mm

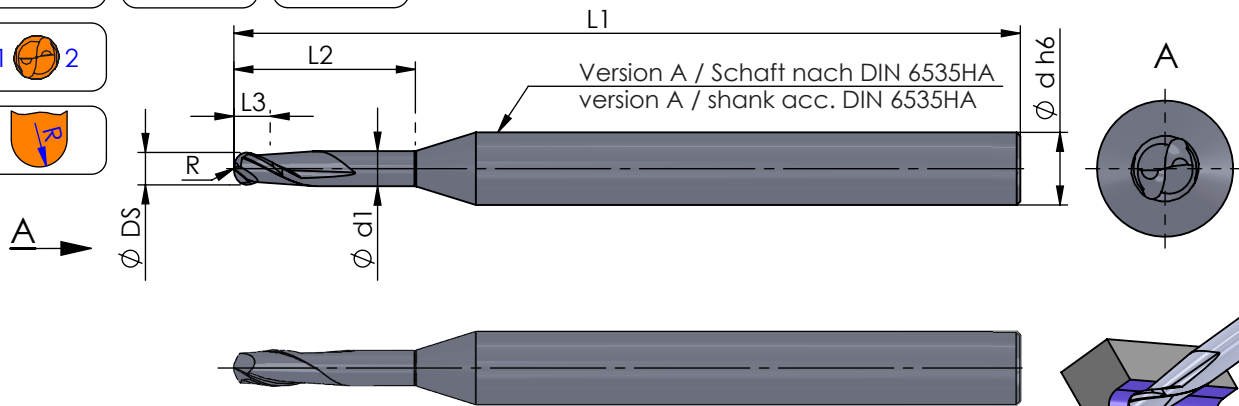
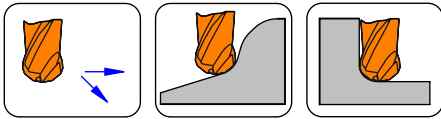

Schneidrichtung (R): wie gezeichnet

cutting direction (R): as shown

Abmessungen in mm

dimensions in mm

Bestellnummer part number	Ø DS	R	Ø d h6	Ø d1	L1	L2	L3	P04C
...								
neu FM0200.060.VR	2.0	1.00	6.0	1.92	55	6.0	2.0	●
neu FM0200.100.VR	2.0	1.00	6.0	1.92	55	10.0	2.0	●
neu FM0200.140.VR	2.0	1.00	6.0	1.92	55	14.0	2.0	●
neu FM0200.160.VR	2.0	1.00	6.0	1.92	65	16.0	2.0	●
neu FM0200.200.VR	2.0	1.00	6.0	1.92	65	20.0	2.0	●
neu FM0230.070.VR	2.3	1.15	6.0	2.22	55	7.0	2.3	●
neu FM0230.115.VR	2.3	1.15	6.0	2.22	55	11.5	2.3	●
neu FM0230.185.VR	2.3	1.15	6.0	2.22	65	18.5	2.3	●
neu FM0230.200.VR	2.3	1.15	6.0	2.22	65	20.0	2.3	●
neu FM0230.230.VR	2.3	1.15	6.0	2.22	65	23.0	2.3	●
neu FM0300.090.VR	3.0	1.50	6.0	2.90	65	9.0	3.0	●
neu FM0300.150.VR	3.0	1.50	6.0	2.90	65	15.0	3.0	●
neu FM0300.240.VR	3.0	1.50	6.0	2.90	100	24.0	3.0	●
neu FM0300.300.VR	3.0	1.50	6.0	2.90	100	30.0	3.0	●

Bestellbeispiel:
für Sorte P04C:
FM0200.060.VR/P04C



order-example:
grade P04C:
FM0200.060.VR/P04C

FM-LINE

VHM - Mikrofräser

solid carbide micro end mills

Technische Hinweise

Schnittdaten

Technical instructions,
cutting data

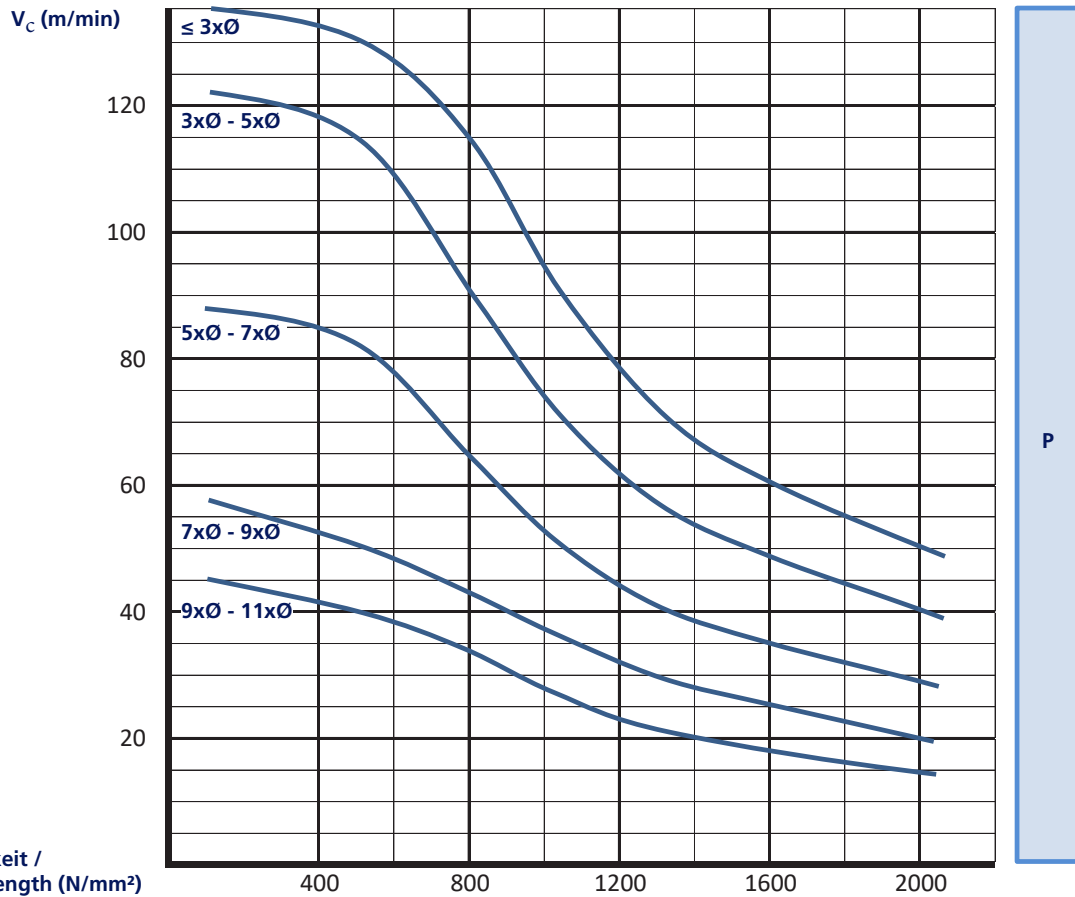

Zugfestigkeit /
tensile strength (N/mm²)

Arbeitseingriff / width of cut	ae :	1x Ø
-----------------------------------	------	------

Länge / length	L2 :	≤ 3x Ø	3x Ø - 5x Ø	5x Ø - 7x Ø	7x Ø - 9x Ø	9x Ø - 11x Ø
Schnitttiefe / depth of cut	ap max. :	0.035x Ø	0.03x Ø	0.025x Ø	0.02x Ø	0.015x Ø

Ø ≙ Ø DS



FM-LINE

VHM - Mikrofräser

solid carbide micro end mills

Technische Hinweise

Schnittdaten

Technical instructions,
cutting data

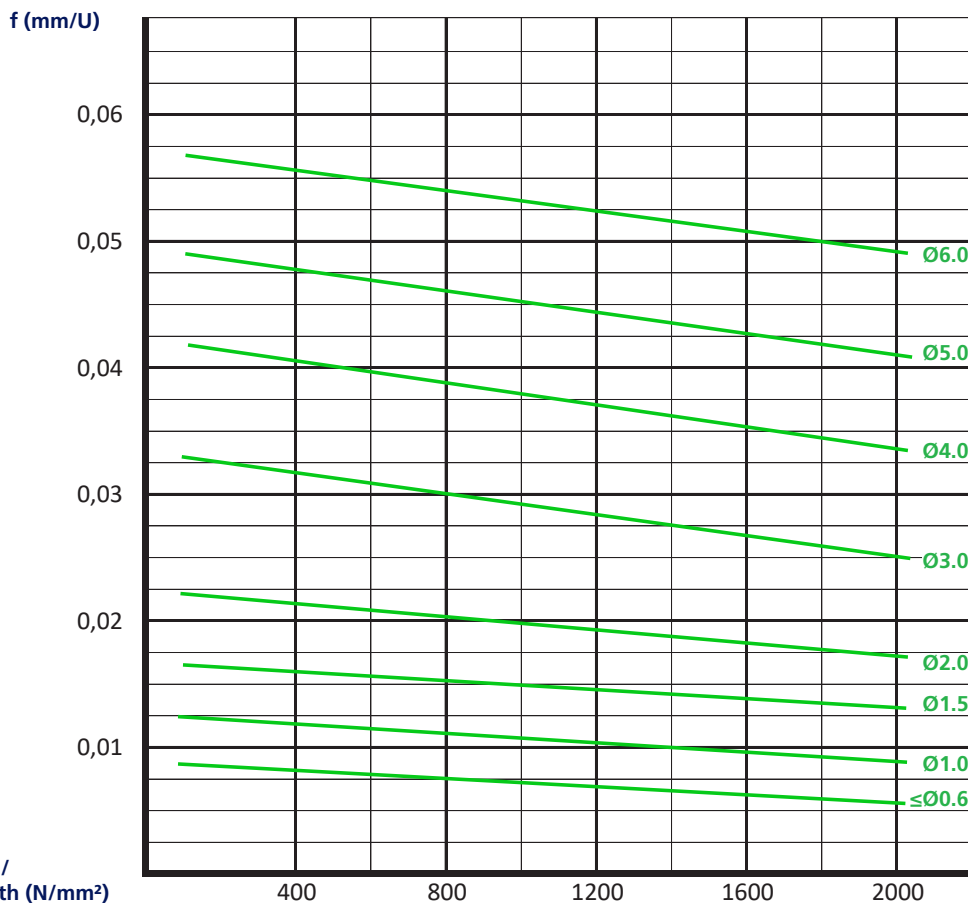



PAUL DÜMMEL WERKZEUGFABRIK GMBH

Werk 1: Lerchenstraße 15
Werk 2: Daimlerstraße 16
D-72584 Hülben

Telefon: 0049 (0) 7125/9691-0
Telefax: 0049 (0) 7125/9691-50

info@duemmel.de
www.duemmel.de

