



TECNOLOGÍA DE BRUÑIDO

BURNISHING TECHNOLOGY





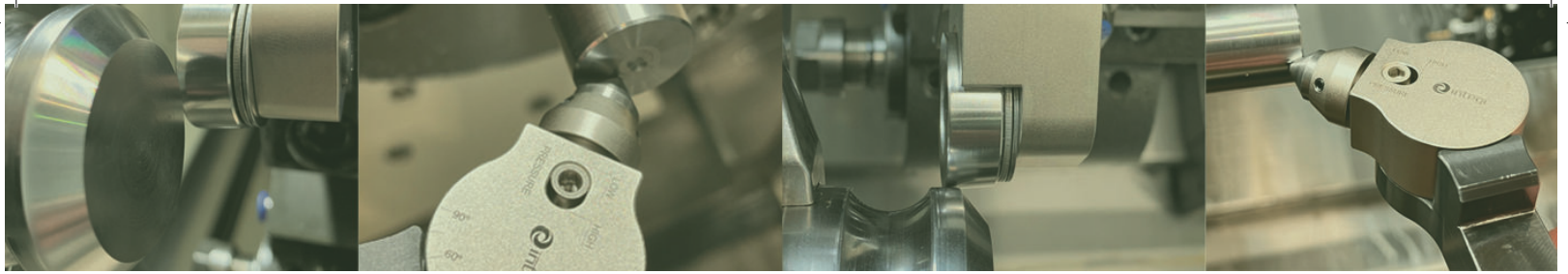

Página
Page



► **Información técnica sobre bruñido**
Technical information about burnishing

4



► **Herramientas de bruñido por rodillo**
Roller burnishing tools

• HBM 20-E	10
• HBM 20-B	11
• HBC 20-E	12
• HBC 20-B	13
• HBU 20	14
• HBU 42	15
• HBE	16
• HBB	17
• HBI 20	18
• Rodillos / Rollers	19



► **Herramientas de bruñido por diamante**
Diamonds burnishing tools

• HBMD	22
• HBCD	23
• HBUD-P	24
• Diamantes / Diamonds	25



HERRAMIENTAS DE BRUÑIDO BURNISHING TOOLS

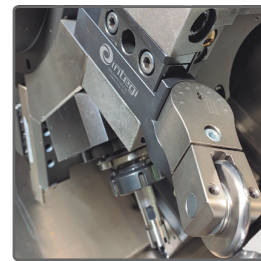
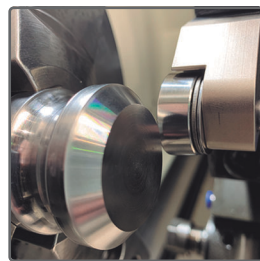

1. Introducción al bruñido

El bruñido es una técnica de mecanizado en la que mediante una herramienta se presiona sobre la superficie de una pieza de menor dureza, aplastando las crestas microscópicas generadas en el mecanizado por arranque de viruta y reduciendo así su rugosidad.

Ese aplastamiento de las crestas desplaza el material de las crestas a los valles igualando los desniveles. El resultado final de esta operación es la generación de una superficie pulida, con una rugosidad superficial notablemente inferior.

2. Ventajas del bruñido

- Sistema versátil y de fácil utilización
- Obtención de superficies bruñidas de una manera rápida y eficaz
- Alternativa al rectificado. Permite obtener en torno rugosidades muy bajas, lo que en muchas ocasiones hace innecesario un rectificado posterior
- Notable reducción de la rugosidad. En algunas aplicaciones la reducción puede ser superior al 90%. Se pueden obtener calidades de $Ra < 0.2$
- Ligero endurecimiento de la superficie de la pieza
- Mejora la resistencia a la corrosión debido a la reducción de los poros superficiales
- Reduce la resistencia a la abrasión debido al menor rozamiento que ofrece una superficie bruñida
- Eliminación de marcas superficiales
- Proceso económico, con un bajo consumo de repuestos
- Proceso rápido con Vc alto
- No genera residuos

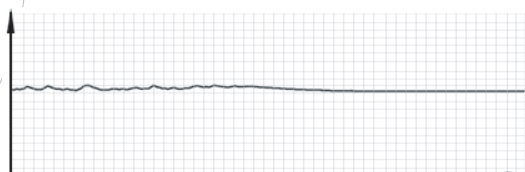

Antes del bruñido
Before burnishing

Después del bruñido
After roller burnishing



Antes del bruñido
Before burnishing

Después del bruñido
After roller burnishing



Antes del bruñido
Before burnishing



Después del bruñido
After roller burnishing

1. Introduction of burnishing

Burnishing is a machining technique in which a tool is pressed on the surface of a part of lower hardness, crushing the microscopic ridges generated in machining by chip removal and thus reducing its roughness.

This crushing of the ridges displaces the material from the ridges to the valleys and evens out the unevenness. The result of this operation is the generation of a polished surface, with a significantly lower surface roughness.

2. Advantages of burnishing

- Versatile and easy to use system
- Obtaining burnished surfaces in a fast and efficient way
- Alternative to grinding. It allows obtaining very low roughness working on the lathe, which in many occasions makes unnecessary the grinding process
- Significant reduction of roughness. In some applications the reduction can be higher than 90%. $Ra < 0.2$ can be obtained
- Slight hardening of the workpiece surface
- Improved corrosion resistance due to reduction of surface pores
- Reduced abrasion resistance due to the lower friction offered by a burnished surface
- Elimination of surface marks
- Economical process with low spare parts consumption
- Fast process with high Vc rates
- No waste



HERRAMIENTAS DE BRUÑIDO BURNISHING TOOLS



Para lograr un buen bruñido hay que tener en cuenta los siguientes puntos:

- Se debe partir de una superficie con acabado superficial, [Ra 3,2 - 6,3] y no debe tener desgarraduras, ni estrías, ni presencia de viruta.
- La superficie debe estar bien dimensionada. Al bruñir el diámetro sufre una variación dimensional entre 0,01 - 0,02 mm y se debe controlar este factor para obtener la pieza dentro de la tolerancia requerida.
- Se debe tener en cuenta el espesor de la pieza a bruñir, ya que la pieza tiene que soportar la fuerza compresiva del bruñido.
- Refrigerante para evitar el sobrecalentamiento de la herramienta y lubricante para componentes de rodadura.

3. Tipos de herramientas de bruñido BURNI-SHINE

En INTEGI fabricamos dos tipos de herramientas de bruñido. Herramientas de rodillo templado y de punta de diamante.

Las herramientas de rodillo utilizan un rodillo de acero rápido templado a 62-63 HRC y con su superficie pulida con un valor Ra 0.15-0.4. Las herramientas de bruñido por rodillo son utilizables únicamente en materiales con una dureza máxima de 40-45 HRC, por lo que no son utilizables en piezas templadas.

Las herramientas de punta de diamante utilizan una punta de diamante de diferente radio, en función del material a bruñir y del grado de Ra a obtener. Las herramientas de punta de diamante se pueden utilizar en piezas de durezas hasta 63 HRC y con ellas se logra obtener además mejores acabados superficiales llegando fácilmente a valores por debajo de Ra 0.2.

4. Ventajas de las herramientas de bruñido BURNI-SHINE

- Posibilidad de regular la presión ejercida por la herramienta para lograr diferentes niveles de calidad en la pieza.
- Posibilidad de trabajar en piezas de diferentes \varnothing s y de diversos materiales ya sean férricos o no férricos.
- Herramientas simples, de fácil utilización y con pocos elementos susceptibles de ser cambiados por desgaste y/o posible rotura por colisión.
- En las herramientas de rodillo estos van montados y/o apoyados sobre rodamientos axiales o radiales, para facilitar el giro y suavizar el movimiento.
- En las herramientas de diamante las puntas tienen 3 posiciones de orientado para prolongar su rendimiento.
- Tanto los rodillos como los diamantes son elementos reemplazables que se pueden adquirir por separado.

To achieve a good burnishing, the following points must be considered:

- The previous surface must be a good finished (Ra 3.2 - 6.3) and must not have tears, nor striations, nor presence of chips.
- The surface must be well dimensioned. When burnishing, the diameter suffers a dimensional variation between 0.01-0.02 mm and this factor must be controlled to obtain the part within the required tolerance.
- The thickness of the part to be burnished must be considered, since the part has to withstand the compressive force of the burnishing tool.
- It is necessary to use coolant to avoid overheating of the tool and to lube the rolling components.

3. Types of burnishing tools BURNI-SHINE

At INTEGI we manufacture two types of burnishing tools. Hardened roller tools and diamond tipped tools.

Roller tools use a HSS roller hardened to 62-63 HRC and with its surface polished to Ra 0.15-0.4. Roller burnishing tools are usable only on materials with a maximum hardness of 40-45 HRC, so they are not usable on hardened parts.

Diamond burnishing tools use a diamond tip of different radius, depending on the material to be burnishing and the Ra to be obtained. Diamond burnishing tools can be used on parts with hardness up to 63 HRC and they can also be used to obtain better surface finishes, easily reaching values below Ra 0.2.

4. Advantages of BURNI-SHINE burnishing tools

- Possibility to regulate the pressure exerted by the tool, to achieve different levels of part roughness.
- Possibility of working on parts of different diameters and different materials, both ferrous and non-ferrous.
- Simple tools, easy to use and with few elements susceptible to be changed due to wear and/or possible breakage due to collision.
- On roller burnishing tools, the rollers are mounted and/or supported on axial or radial bearings, to facilitate turning and smooth the movement.
- On diamond burnishing tools, the tips can be mounted in 3 different orientations to increase the tool life.
- Both rollers and diamond tips are replaceable elements that can be purchased separately.



HERRAMIENTAS DE BRUÑIDO BURNISHING TOOLS



5. Preparación de la superficie de la pieza para el bruñido

La superficie de la pieza de trabajo debe ser adecuada para el bruñido. Se recomienda un torneado previo de la mejor calidad posible ya que cuanto mejor sea la calidad de torneado previo, mejor calidad se obtendrá tras el bruñido.

Hay que tener en cuenta que la operación de bruñido, ya sea mediante rodillo o diamante, no corta el material sino que lo aplasta. Este aplastamiento se traduce en una reducción del \varnothing de la pieza la cual hay que tener en cuenta previo al bruñido.

5.1 Parametros de trabajo

Se recomienda trabajar con una $V_c=100-200$ m/min y un avance de 0.05 - 0.20 mm/vuelta.

En el caso de requerir un mejor acabado se recomienda reducir el avance y aumentar la presión del rodillo si fuera posible. En caso de materiales blandos se recomienda reducir la presión del rodillo al mínimo posible.

SISTEMAS DE BRUÑIDO POR RODILLO

6. Ajuste de la regulación de la presión

Las herramientas modelos HBU 42, HBE y HBB disponen de un sencillo sistema de regulación de la presión que ejerce el rodillo y así poder lograr diferentes niveles de bruñido.

La regulación se hace por medio de un tornillo de ajuste de carga situado bien en el mango de la herramienta (Fig. 1) o en la cabeza de la herramienta (Fig. 2)



(Fig.1)

El nivel de la presión se visualiza según la posición del indicador de carga.

Hay 3 niveles marcados con los números "0-1-2" donde el "0" indica carga baja y el "2" es la carga máxima.

Tanto el tornillo de ajuste de carga como la abertura donde visualizar el nivel de carga están situados en la cabeza o en el mango de la herramienta, según el modelo elegido. Si bien se recomienda trabajar siempre con el regulador en la posición "2" para lograr el mejor acabado en la pieza, si el valor de rugosidad requerido es inferior al logrado, se puede trabajar con menor presión para preservar la vida útil del resorte.



Indicador en posición 0 / Presión baja
Stop in position 0 / Low pressure



Indicador en posición 1 / Presión media
Stop in position 1 / Medium pressure



Indicador en posición 2 / Presión alta
Stop in position 2 / High pressure

5. Preparation of the workpiece for the burnishing

The workpiece surface must be suitable for burnishing.

It is recommended to pre-turning of the best possible quality, since the better the quality of the pre-turning, the better quality will be obtained after burnishing.

It should be borne in mind that the burnishing operation, whether by roller or diamond, does not cut the material but crushes it. This crushing results in a reduction of the \varnothing of the part, which must be taken into account prior to burnishing.

The value of the reduction depends mainly on the type of steel, the pressure exerted and the previous roughness.

5.1 Working parameters

It is recommended to work with a $V_c=100-200$ m/min and a feed rate of 0.05 - 0.20 mm/turn.

If a better finish is required, it is recommended to reduce the feed rate and increase the tool pressure if possible. In case of soft materials, it is recommended to reduce the tool pressure to the minimum possible.

ROLLER BURNISHING SYSTEM

6. Pressure regulation adjustment

HBU 42, HBE and HBB tools have a simple system for adjusting the pressure exerted by the roller to achieve different burnishing levels.

The regulation is made by means of a load adjustment screw placed either on the tool shank (Fig. 1) or on the tool head (Fig. 2).



(Fig.2)

The pressure level is displayed according to the position of the load indicator.

There are 3 levels marked with the numbers "0-1-2" where "0" indicates low load and "2" is the maximum load.

Both the load adjustment screw and the window where the load level is displayed are located on the tool head or on the tool shank, depending on the model. Although it is recommended to always work with the load level in position "2" to achieve the best finish on the part, if the required roughness value is lower than the achieved, then it is better to reduce the load and work with lower pressure to preserve the life of the spring.



HERRAMIENTAS DE BRUÑIDO BURNISHING TOOLS



Los pasos a seguir son:

1. Posicionar el rodillo rozando contra el Ø a bruñir y presionar contra la pieza hasta que la cabeza portarodillo se contraiga entre 0.1 - 0.2 mm (AP). Nunca trabajar con la cabeza de la herramienta comprimida al máximo. Si la cabeza se comprime hasta llegar a tocar el mango o cuerpo de la herramienta, esta dejará de hacer su efecto y la herramienta trabajará como si se tratará de una herramienta rígida.

La distancia que media entre la cabeza portarodillo y el mango depende de cada modelo.

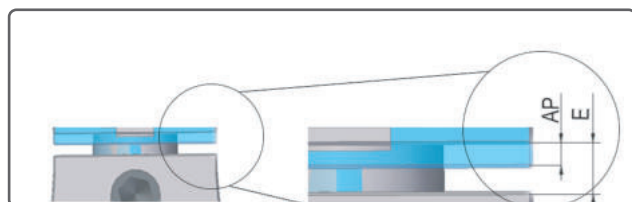

2. Avanzar con un $f=0.1 - 0.2$ mm/vuelta. Es necesario que la herramienta trabaje con refrigeración para lograr un mejor acabado de bruñido.

SISTEMAS DE BRUÑIDO POR DIAMANTE

1. Previo al bruñido hay que asegurarse que la rugosidad superficial anterior al bruñido no sea superior a Ra 4. Una rugosidad superior puede dañar la punta de diamante. En el caso de que sea imposible lograr el valor de rugosidad previa requerido, se recomienda previo a la utilización del bruñidor de diamante, bruñir la superficie con una herramienta de bruñir de rodillo hasta lograr una $Ra < 4$.
2. Colocar la punta de diamante alineada con el eje de giro de la pieza a bruñir y perpendicular (si es posible) a la superficie a bruñir.
3. La punta de diamante va precargada de fábrica. El sistema de resortes permite una compresión máxima de 1.0 mm, aun así, se recomienda que la presión que se ha de ejercer con el diamante sobre la superficie de la pieza no sea superior a 0.1 mm en materiales férricos y de 0.005 mm en materiales no férricos.
4. Avanzar con un $f=0.05-0.20$ mm/vuelta. Es necesario que la herramienta trabaje con refrigeración para lograr un mejor acabado de bruñido y evitar deterioro del diamante.



The steps to follow are:

1. Place the roller touching the Ø to be burnished and press against the workpiece until the tool head contracts between 0.1 - 0.2 mm (AP). Do not work with the tool head compressed to the maximum. If the head is compressed until it touches the shank or the tool body, it will stop working and the tool will work as if it were rigid.

The distance "E" between the tool head and the shank depends on each model.

Modelo Model	E
HBU 42	1.5 mm
HBE 25	1.5 mm
HBB 30	1.5 mm
HBU 20	1.7 mm
HBM 20	1.7 mm
HBC 20	1.7 mm

2. Feed with an $f=0.1 - 0.2$ mm/turn. Coolant is necessary to achieve a better burnishing finish.

DIAMOND BURNISHING SYSTEM

Prior to burnishing, make sure that the turning surface roughness is not higher than Ra 4. Higher roughness can damage the diamond tip.

In case it is not possible to achieve the required pre-roughness value, it is recommended to burnish the surface with a roller burnishing tool to $Ra < 4$ before using the diamond burnishing tool.

2. Place the diamond tip aligned with the part rotation axis and perpendicular (if possible) to the surface to be burnished.
3. The tool head, where the diamond tip is mounted, is supplied preloaded. The spring system allows a maximum compression of 1.0 mm. However, it is recommended that the pressure to be exerted with the diamond on the surface of the part should not exceed 0.1 mm in ferrous materials and 0.005 mm in non-ferrous materials.
4. Feed with $f=0.05-0.20$ mm/turn. always work with coolant to achieve a better burnishing finish and avoid diamond damage.



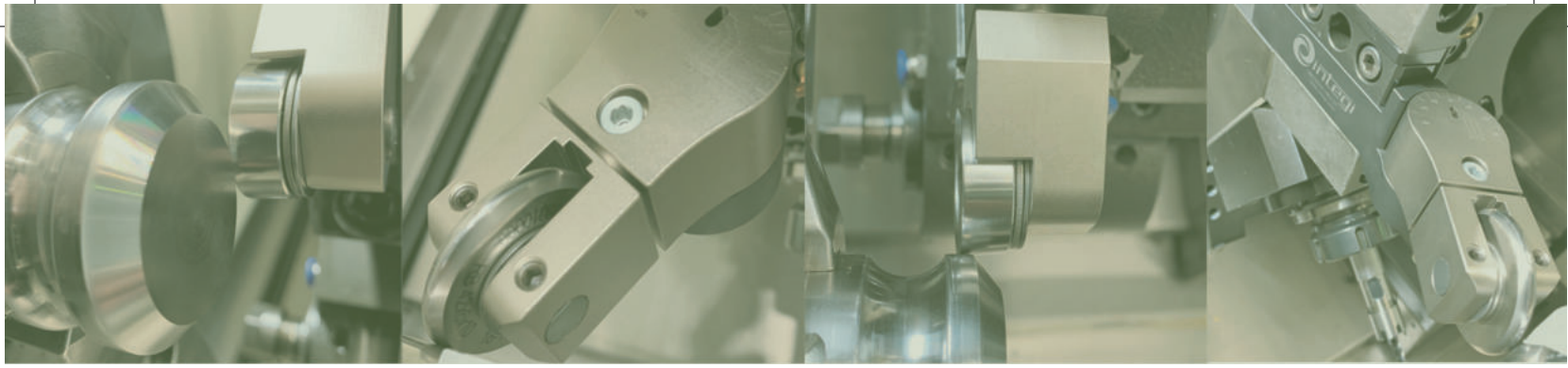

HERRAMIENTAS DE BRUÑIDO POR RODILLO

ROLLER BURNISHING TOOLS





HERRAMIENTAS DE BRUÑIDO BURNISHING TOOLS



HBM 20-E

+ Características

- Herramienta diseñada para bruñir en tornos de cabezal móvil, superficies exteriores de formas variadas
- Cabeza provista de un sistema interno de resorte que regula la presión haciéndola homogénea en todas las piezas (Fig.1)
- Rodillo soportado entre rodamientos axiales
- Utilizable sobre piezas de diferentes tipos de materiales con durezas de hasta 45 HRC
- Eje porta-rodillo de metal duro
- Provisto de rodillo de bruñir de perfil tipo U fabricado en HSS y templado a 62 HRC, con superficie pulida con una Ra<0.4

+ Features

- Tool designed for burnishing on sliding head lathes, on various profiles
- Head provided with an internal spring system that regulates the pressure making it homogeneous in all the workpieces (Fig.1)
- The roller is supported between axial bearings
- Usable on workpieces of different types of materials with hardness up to 45 HRC
- Carbide pin
- Provided with a U type burnishing roller made of HSS and hardened to 62 HRC, with polished surface Ra<0.4

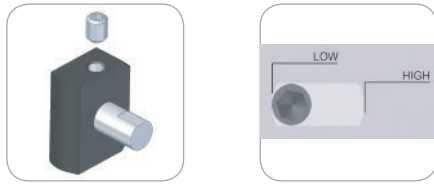

(Fig.1)

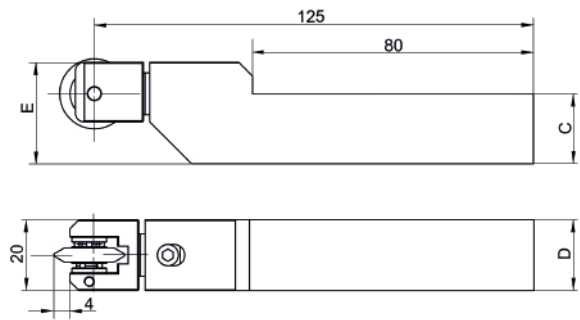

+ Avance Feed

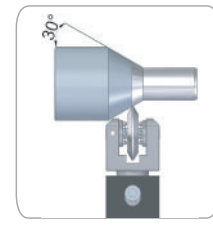
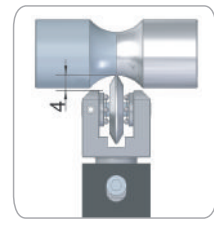
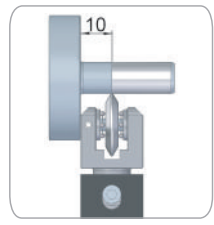
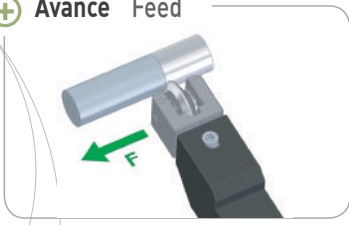

Herramienta Tool							
Código Code	Referencia Reference	Versión Version	Rodillos Rolls	C	D	E	Kg
09050100	HBM 20.12 R-E	R	RB 20x4x4	12	12	21	0.3
09050102	HBM 20.12 L-E	L	RB 20x4x4	12	12	21	0.3
09050200	HBM 20.16 R-E	R	RB 20x4x4	16	16	25	0.4
09050202	HBM 20.16 L-E	L	RB 20x4x4	16	16	25	0.4
09050300	HBM 20.20-E	R+L	RB 20x4x4	20	20	29	0.5

Repuesto Spare Part		
Código Code	Referencia Reference	
01990602	E 20.4 HM	
09990013	RODAX Ø4	



HERRAMIENTAS DE BRUÑIDO BURNISHING TOOLS



HBM 20-B

+ Características

- Herramienta diseñada para bruñir en tornos de cabezal móvil, superficies exteriores de formas variadas
- Posibilidad de bruñir hasta una cara
- Cabeza provista de un sistema interno de resorte que regula la presión haciéndola homogénea en todas las piezas (Fig.1)
- Rodillo soportado entre rodamiento axial y radial
- Utilizable sobre piezas de diferentes tipos de materiales con durezas de hasta 45 HRC
- Provisto de rodillo de bruñir de perfil tipo B fabricado en HSS y templado a 62 HRC, con superficie pulida con una $Ra < 0.4$

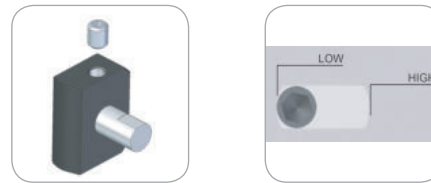

(Fig.1)



+ Features

- Tool designed for burnishing on sliding head lathes, on various profiles
- Possibility of burnishing up to one face
- Head provided with an internal spring system that regulates the pressure making it homogeneous in all the workpiece (Fig.1)
- The roller is supported between axial and radial bearing
- Usable on workpieces of different types of materials with hardness up to 45 HRC
- Provided with a B type burnishing roller made of HSS and hardened to 62 HRC, with polished surface $Ra < 0.4$

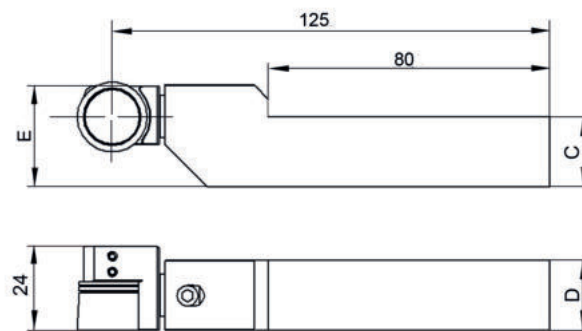

+ Avance Feed

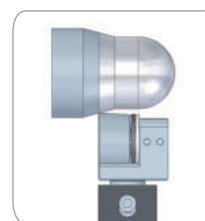
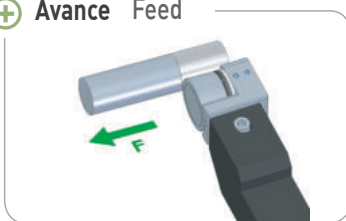

Herramienta Tool							
Código Code	Referencia Reference	Versión Version	Rodillos Rolls	C	D	E	Kg
09050101	HBM 20.12 R-B	R	RB 20x11x16/13	12	12	21	0.3
09050103	HBM 20.12 L-B	L	RB 20x11x16/13	12	12	21	0.3
09050201	HBM 20.16 R-B	R	RB 20x11x16/13	16	16	25	0.4
09050203	HBM 20.16 L-B	L	RB 20x11x16/13	16	16	25	0.4
09050301	HBM 20.20 R-B	R	RB 20x11x16/13	20	20	29	0.5
09050302	HBM 20.20 L-B	L	RB 20x11x16/13	20	20	29	0.5

Repuesto Spare Part		
Código Code	Referencia Reference	
09990020	HB 20-EJE-CABEZA B	
09990008	RODAX Ø6	
09990019	RODRAD Ø6	



HERRAMIENTAS DE BRUÑIDO BURNISHING TOOLS



HBC 20-E

+ Características

- Herramienta diseñada para bruñir en tornos de cabezal móvil, superficies exteriores de formas variadas
- Cabeza provista de un sistema interno de resorte que regula la presión haciéndola homogénea en todas las piezas (Fig.1)
- Rodillo soportado entre rodamientos axiales
- Utilizable sobre piezas de diferentes tipos de materiales con durezas de hasta 45 HRC
- Eje porta-rodillo de metal duro
- Provisto de rodillo de bruñir de perfil tipo U fabricado en HSS y templado a 62 HRC, con superficie pulida con una Ra<0.4

+ Features

- Tool designed for burnishing on sliding head lathes, on various profiles
- Head provided with an internal spring system that regulates the pressure making it homogeneous in all the workpieces (Fig.1)
- The roller is supported between axial bearings
- Usable on workpieces of different types of materials with hardness up to 45 HRC
- Carbide pin
- Provided with U type burnishing roller made of HSS and hardened to 62 HRC, with polished surface Ra<0.4

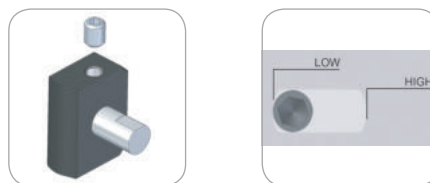

(Fig.1)

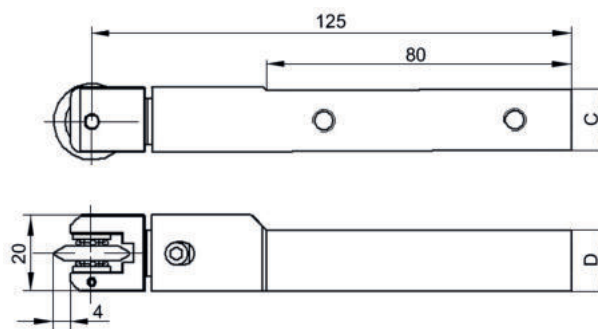
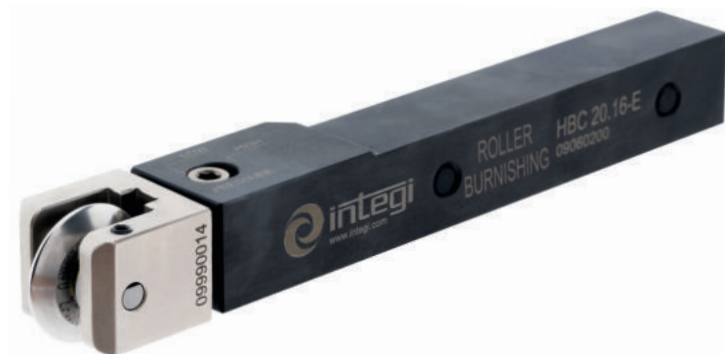

+ Avance Feed

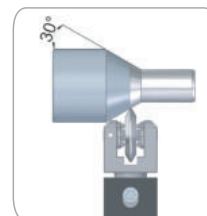
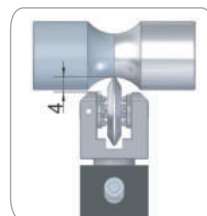
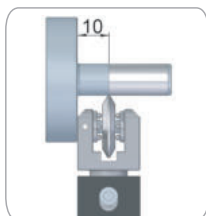
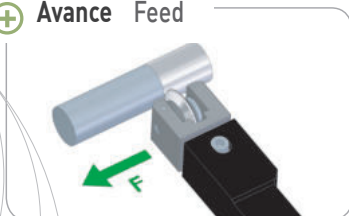

Herramienta Tool						
Código Code	Referencia Reference	Versión Version	Rodillos Rolls	C	D	Kg
09060100	HBC 20.12-E	R+L	RB 20x4x4	12	16	0.3
09060200	HBC 20.16-E	R+L	RB 20x4x4	16	16	0.3

Repuesto Spare Part		
Código Code	Referencia Reference	
01990602	E 20.4 HM	
09990013	RODAX Ø4	



HERRAMIENTAS DE BRUÑIDO BURNISHING TOOLS



HBC 20-B

+ Características

- Herramienta diseñada para bruñir en tornos de cabezal móvil, superficies exteriores de formas variadas
- Posibilidad de bruñir hasta una cara
- Cabeza provista de un sistema interno de resorte que regula la presión haciéndola homogénea en todas las piezas (Fig.1)
- Rodillo soportado entre rodamiento axial y radial
- Utilizable sobre piezas de diferentes tipos de materiales con durezas de hasta 45 HRC
- Provisto de rodillo de bruñir de perfil tipo B fabricado en HSS y templado a 62 HRC, con superficie pulida con una Ra<0.4

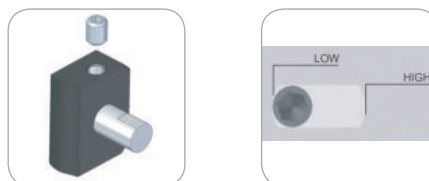

(Fig.1)



+ Features

- Tool designed for burnishing on sliding head lathes, on various profiles
- Possibility of burnishing up to one face
- Head provided with an internal spring system that regulates the pressure making it homogeneous in all the parts (Fig.1)
- The roller is supported between axial and radial bearing
- Usable on workpieces of different types of materials with hardness up to 45 HRC
- Provided with a B type burnishing roller made of HSS and hardened to 62 HRC, with polished surface Ra<0.4

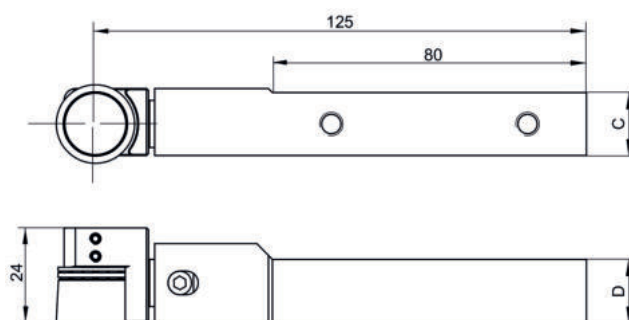

+ Avance Feed

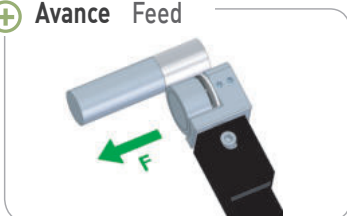

Herramienta Tool						
Código Code	Referencia Reference	Versión Version	Rodillos Rolls	C	D	Kg
09060101	HBC 20.12-B	R+L	RB 20x11x16/13	12	16	0.3
09060201	HBC 20.16-B	R+L	RB 20x11x16/13	16	16	0.4

Repuesto Spare Part		
Código Code	Referencia Reference	
09990020	HB 20-EJE-CABEZA B	
09990008	RODAX Ø6	
09990019	RODRAD Ø6	

HERRAMIENTAS DE BRUÑIDO BURNISHING TOOLS



HBU 20

+ Características

- Herramienta diseñada para bruñir en tornos, superficies exteriores de formas variadas
- Cabeza giratoria con escala graduada (Fig.1&2)
- Cabeza provista de un sistema interno de resorte que regula la presión haciéndola homogénea en toda la pieza (Fig.3)
- Rodillo soportado sobre rodamientos axiales
- Utilizable sobre piezas de diferentes tipos de materiales con durezas hasta 45HRC
- Eje porta-rodillo de metal duro
- Provista de rodillo de bruñir de perfil tipo U fabricado en HSS y templado a 62 HRC, con superficie pulida con una Ra<0.4

+ Features

- Tool designed for burnishing on lathes, on various profiles
- Rotating head with graduated scale (Fig.1&2)
- Head provided with an internal spring system that regulates the pressure making it homogeneous in all the workpieces (Fig.1)
- The roller is supported between axial bearings
- Usable on workpieces of different types of materials with hardness up to 45 HRC
- Carbide pin
- Provided with a U type burnishing roller made of HSS and hardened to 62 HRC, with polished surface Ra<0.4

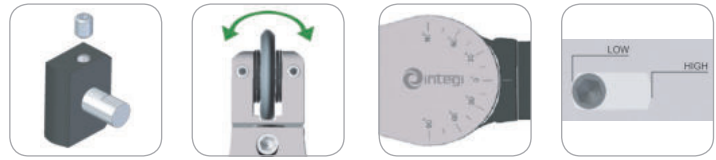

(Fig.1)

(Fig.2)

(Fig.3)

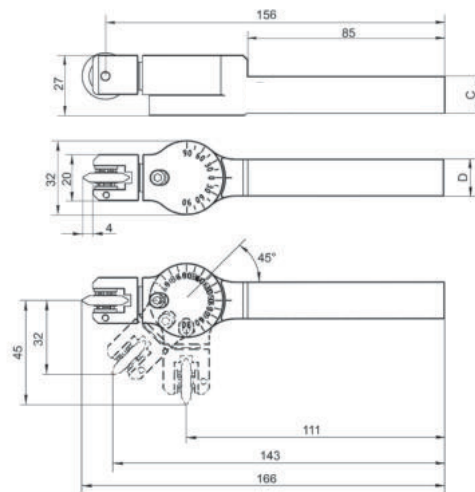
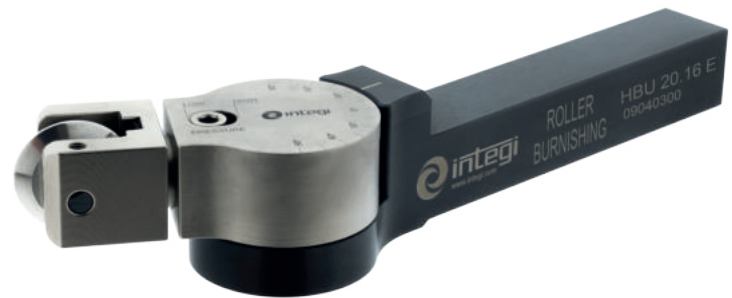

+ Avance Feed

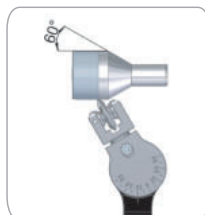
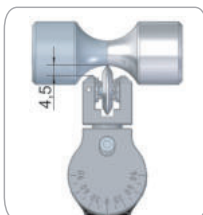
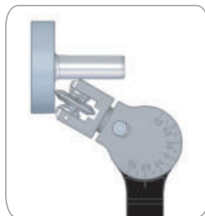
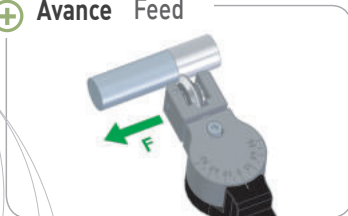

Herramienta Tool						
Código Code	Referencia Reference	Versión Version	Rodillos Rolls	C	D	Kg
09040100	HBU 20.10	R+L	RB 20x4x4	10	16	0.3
09040200	HBU 20.12	R+L	RB 20x4x4	12	16	0.3
09040300	HBU 20.16	R+L	RB 20x4x4	16	16	0.4

Repuesto | Spare Part

Código Code	Referencia Reference	
01990602	E 20.4 HM	
09990013	RODAX Ø4	



HERRAMIENTAS DE BRUÑIDO BURNISHING TOOLS



HBU 42

+ Características

- Herramienta diseñada para bruñir en tornos, superficies exteriores de formas variadas
- Cabeza giratoria con escala graduada (Fig.1&2)
- Rodillo soportado entre rodamientos axiales
- Utilizable sobre piezas de diferentes tipos de materiales con durezas de hasta 45 HRC
- Eje porta-rodillo de metal duro
- Provisto de rodillo de bruñir de perfil tipo U fabricado en HSS y templado a 62 HRC, con superficie pulida con una Ra<0.4

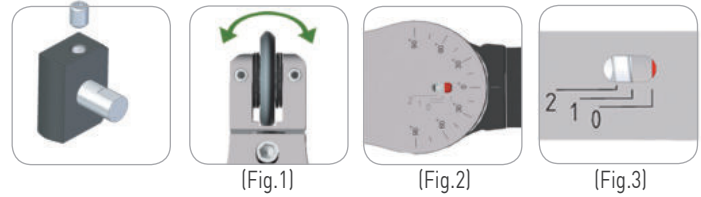

+ Features

- Tool designed for burnishing on lathes, on various profiles
- Rotating head with graduated scale (Fig.1&2)
- The roller is supported between axial bearings
- Usable on workpieces of different types of materials with hardness up to 45 HRC
- Carbide pin
- Provided with a U type burnishing roller made of HSS and hardened to 62 HRC, with polished surface Ra<0.4

+ Avance Feed

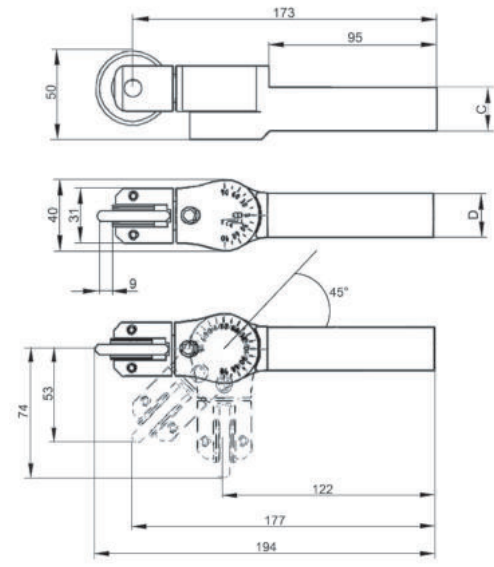
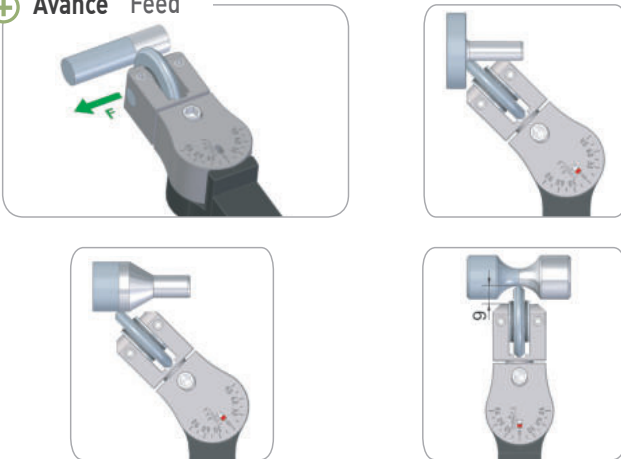

Herramienta Tool						
Código Code	Referencia Reference	Versión Version	Rodillos Rolls	C	D	Kg
09010400	HBU 42.20	R+L	RB 42x6x10	20	25	1.2
09010500	HBU 42.25	R+L	RB 42x6x10	25	25	1.2

Repuesto Spare Part		
Código Code	Referencia Reference	
09019901	E 31.10 HM	
09990009	RODAX Ø10	

HERRAMIENTAS DE BRUÑIDO BURNISHING TOOLS



HBE

+ Características

- Herramienta diseñada para bruñir en torno, superficies exteriores de formas variadas
- Rodillo soportado entre rodamientos axiales
- Posibilidad de variar la presión de la cabeza para lograr diferentes niveles de bruñido en la pieza (Fig.1)
- Eje porta-rodillo de metal duro
- Utilizable sobre piezas de diferentes tipos de materiales con durezas hasta 45 HRC
- Provisto de rodillo de bruñir de perfil tipo E fabricado en HSS y templado a 62 HRC con superficie pulida con una Ra<0.4

+ Features

- Tool designed for burnishing on lathes, on various profiles
- The roller is supported between axial bearings
- The pressure of the head can be adjusted in order to obtain different levels of burnishing on the workpiece (Fig.1)
- Carbide pin
- Usable on workpieces of different types of materials with hardness up to 45 HRC
- Provided with a E type burnishing roller made of HSS and hardened to 62 HRC, with polished surface Ra<0.4

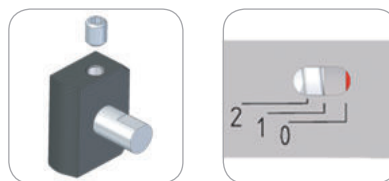

(Fig.1)

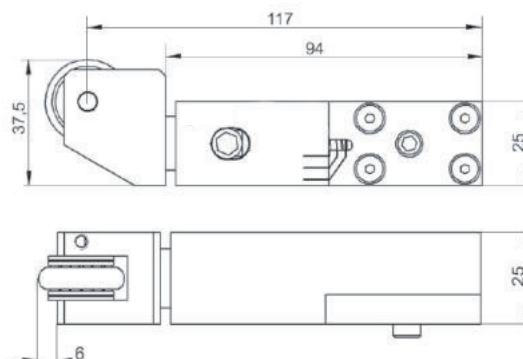

+ Avance Feed

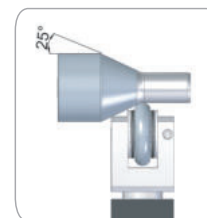
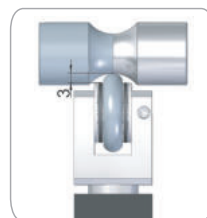
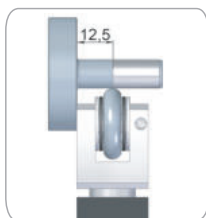
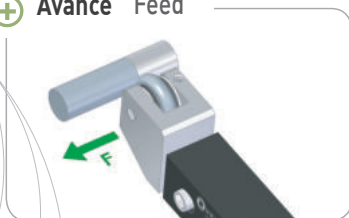

Herramienta Tool				
Código Code	Referencia Reference	Versión Version	Rodillos Rolls	Kg
09020100	HBE 25.25	R+L	RB 25x6x6	0.8

Repuesto | Spare Part

Código Code	Referencia Reference	
09029901	E 25.6 HM	
09990008	RODAX Ø6	



HERRAMIENTAS DE BRUÑIDO BURNISHING TOOLS



HBB

+ Características

- Herramienta diseñada para bruñir en torno, superficies exteriores de formas variadas
- Rodillo soportado entre rodamiento axial y radial
- Posibilidad de variar la presión de la cabeza para lograr diferentes niveles de bruñido en la pieza (Fig.1)
- Para bruñidos hasta una cara
- Utilizable sobre piezas de diferentes tipos de materiales con durezas de hasta 45 HRC
- Provisto de rodillo de bruñir de perfil tipo B fabricado en HSS y templado a 62 HRC, con superficie pulida con una Ra<0.4

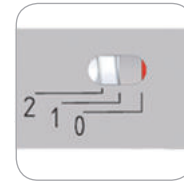
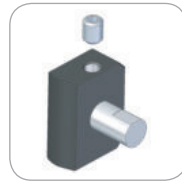

(Fig.1)



+ Features

- Tool designed for burnishing on lathes, on various profiles
- The roller is supported between axial and radial bearings
- The pressure of the head can be adjusted in order to obtain different levels of burnishing on the workpiece (Fig.1)
- Possibility of burnishing up to one face
- Usable on workpieces of different types of materials with hardness up to 45 HRC
- Provided with a B type burnishing roller made of HSS and hardened to 62 HRC, with polished surface Ra<0.4

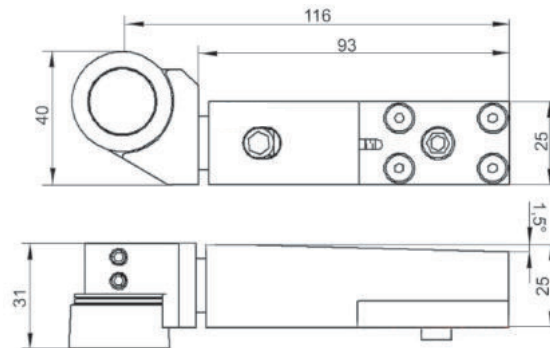

+ Avance Feed

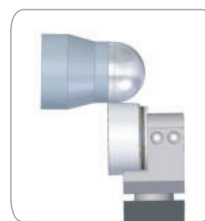
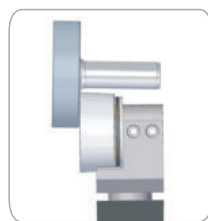
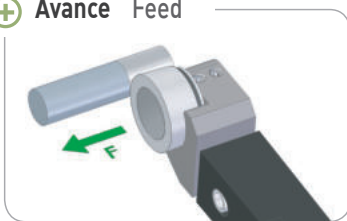

Herramienta Tool				
Código Code	Referencia Reference	Versión Version	Rodillos Rolls	Kg
09030200	HBB 30.25 L	L	RB 30x13x20/17	0.8
09030100	HBB 30.25 R	R	RB 30x13x20/17	0.8

Repuesto Spare Part		
Código Code	Referencia Reference	
09039902	HBB 30-EJE	
09990010	RODRAD Ø10	
09990009	RODAX Ø10	



HERRAMIENTAS DE BRUÑIDO BURNISHING TOOLS



HBI 20

+ Características

- Herramienta diseñada para bruñir en tornos, superficies interiores y/o exteriores.
- Para bruñir orificios desde $\varnothing 22$ mm x 70 mm de profundidad
- Cabeza provista de un sistema interno de resorte que regula la presión haciéndola homogénea en todas las piezas (Fig.1)
- Rodillo soportado entre rodamientos axial y radial
- Utilizable sobre piezas de diferentes tipos de materiales con durezas de hasta 45 HRC
- Provisto de un rodillo de bruñir perfil tipo B fabricado en HSS y templado a 62 HRC, con superficie pulida con una $Ra < 0.4$

+ Features

- Tool designed for burnishing internal and/or external surfaces
- For burnishing holes from $\varnothing 22$ mm x 70 mm deep
- Head provided with an internal spring system that regulates the pressure making it homogeneous on all parts (Fig.1)
- The roller is supported between axial and radial bearings
- Usable on workpieces of different types of materials with hardness up to 45 HRC
- Provided with a B type burnishing roller made of HSS and hardened to 62 HRC, with polished surface $Ra < 0.4$

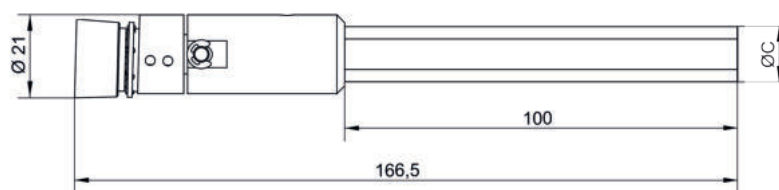

+ Avance Feed

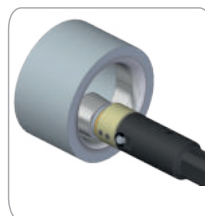
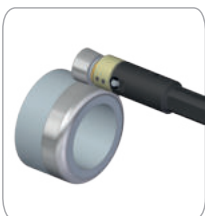
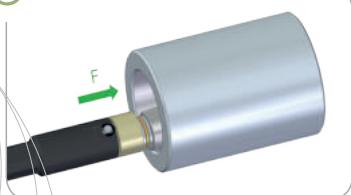

Herramienta Tool						
Código Code	Referencia Reference	Versión Version	Rodillos Rolls	ØC	∅D	Kg
09160100	HBI 20-Ø12	R+L	RB 20x11x16/13	12	10	0.2
09160200	HBI 20-Ø16	R+L	RB 20x11x16/13	16	14	0.3
09160300	HBI 20-Ø20	R+L	RB 20x11x16/13	20	16	0.4

Repuesto | Spare Part

Código Code	Referencia Reference	
09990020	HB 20-EJE-CABEZA B	
09990008	RODAX Ø6	
09990019	RODRAD Ø6	



HERRAMIENTAS DE BRUÑO BURNISHING TOOLS



Rodillos de bruño Burnishing rollers

+ Características

Rodillos de HSS templado a 62HRC
Superficie pulida Ra (0,15-0,40)

+ Features

HSS rollers hardened to 62 HRC
Polished surface Ra (0,15-0,40)

Perfil E Profile E

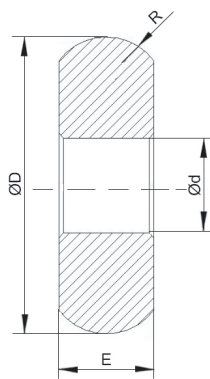

Perfil B Profile B

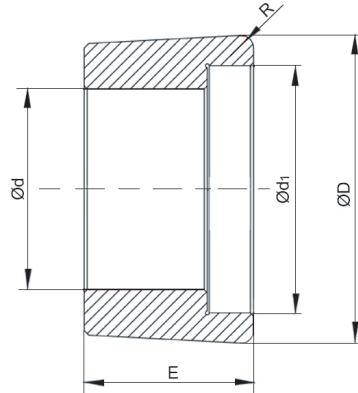

Perfil U Profile U

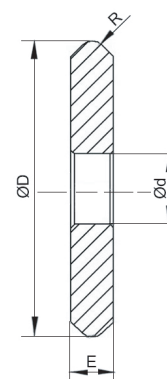

Código Code	Referencia Reference	Perfil Profile	ØD	E	Ød	Ød ₁	R	Herramienta Tool
08010100	RB 10x4x4	E	10	4	4	-	2,5	*
08010200	RB 15x4x4	E	15	4	4	-	2,5	*
08010800	RB 20x8x6	E	20	8	6	-	6	*
08010400	RB 25x8x8	E	25	8	8	-	5	*
08010700	RB 25x6x6	E	25	6	6	-	3,25	HBE
08011000	RB 20x11x16/13	B	20	11	13		0,8	HBM 20-B / HBC 20-B / HBI 20
08010600	RB 30x13x20/17	B	30	13	17	20	0,8	HBB
08010900	RB 20x4x4	U	20	4	4		1,0	HBM 20-E / HBC 20-E / HBU 20
08010000	RB 42x6x10	U	42	6	10	-	2	HBU 42

* Para montar en portamoletas modelos M8 15.04 / M4 20.08 / M4 25.08

* The rolls could be fitted in these tools M8 15.04 / M4 20.08 / M4 25.08

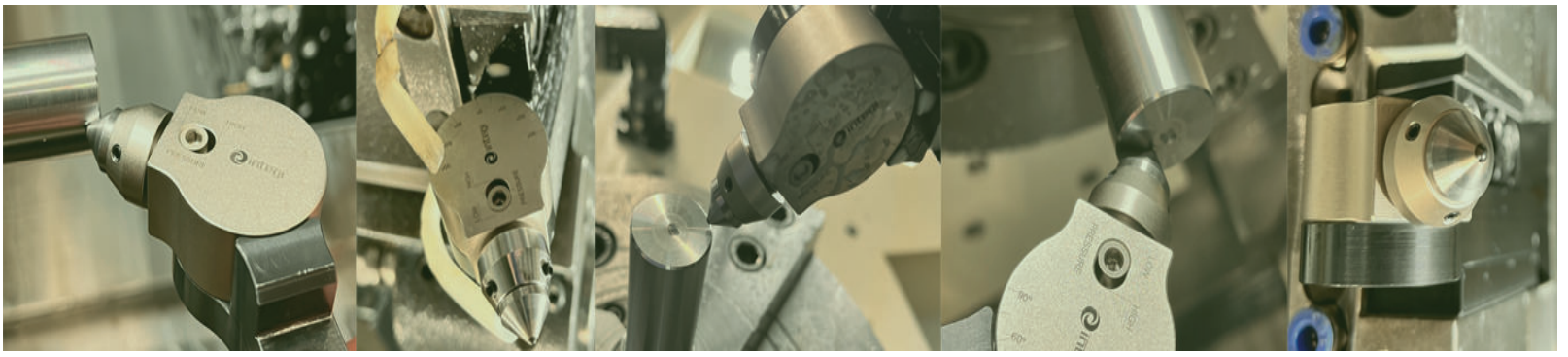

HERRAMIENTAS DE BRUÑIDO POR DIAMANTE

DIAMOND BURNISHING TOOLS





HERRAMIENTAS DE BRUÑIDO BURNISHING TOOLS



HBMD

+ Características

- Herramienta diseñada para bruñir en tornos de cabezal móvil, superficies exteriores de formas variadas
- Cara superior del mango alineada con la punta del diamante
- Cabeza provista de un sistema interno de resorte que regula la presión haciéndola homogénea en todas las piezas (Fig.1)
- Utilizable sobre piezas de diferentes tipos de materiales con durezas de hasta 63 HRC
- Posibilidad de colocar la punta de diamante en diferentes posiciones para prolongar la vida del útil

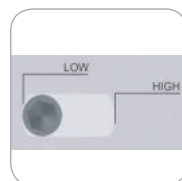

(Fig.1)

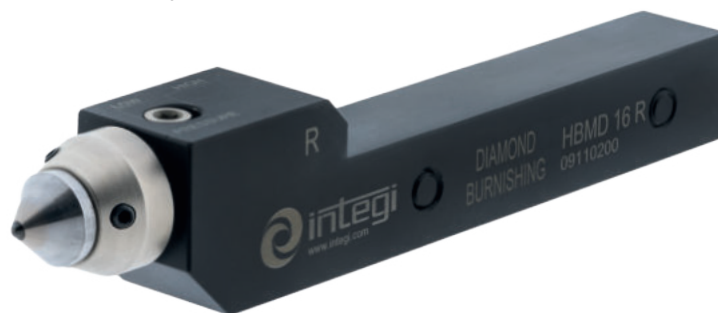

+ Features

- Tool designed for burnishing external diameters of various shapes on sliding head lathes
- Top face of the shank aligned with the diamond tip
- The head is equipped with an internal spring system to regulate the pressure of the diamond tip, making it homogeneous on all parts (Fig.1)
- Can be used on workpieces made of different types of materials with hardness up to 63 HRC
- Possibility of placing the diamond tip in different positions to extend the life of the tool

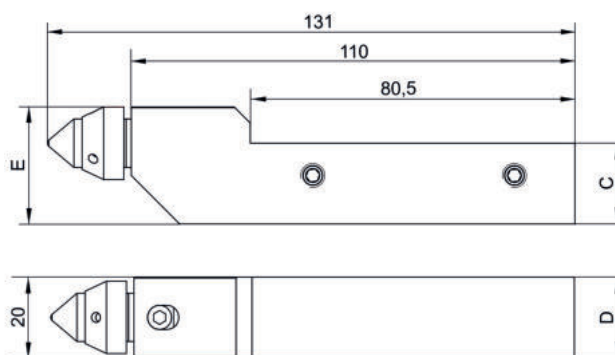

+ Avance Feed

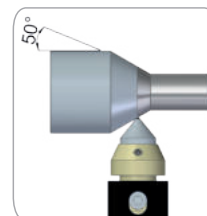
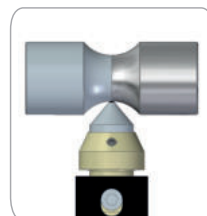
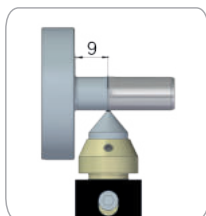
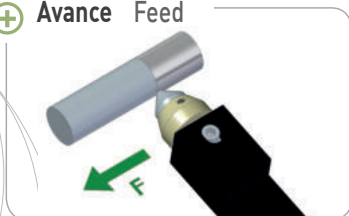

Herramienta Tool							
Código Code	Referencia Reference	Versión Version	Diamante Diamond	C	D	E	Kg
09110100	HBMD 12 R	R	DT 12	12	12	21	0.3
09110101	HBMD 12 L	L	DT 12	12	12	21	0.3
09110200	HBMD 16 R	R	DT 12	16	16	25	0.4
09110201	HBMD 16 L	L	DT 12	16	16	25	0.4
09110300	HBMD 20	R+L	DT 12	20	20	29	0.5

Punta de diamante Diamond tip	
Código Code	Referencia Reference
10010104	DT 12-R0.4
10010108	DT 12-R0.8
10010110	DT 12-R1.0
10010120	DT 12-R2.0





HERRAMIENTAS DE BRUÑIDO BURNISHING TOOLS



HBCD

+ Características

- Herramienta diseñada para bruñir en tornos de cabezal móvil, superficies exteriores de formas variadas
- Mango centrado
- Cabeza provista de un sistema interno de resorte que regula la presión haciéndola homogénea en todas las piezas (Fig.1)
- Utilizable sobre piezas de diferentes tipos de materiales con durezas de hasta 63 HRC
- Posibilidad de colocar la punta de diamante en diferentes posiciones para prolongar la vida del útil

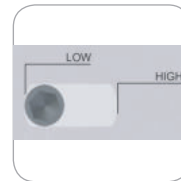

(Fig.1)



+ Features

- Tool designed for burnishing external diameters of various shapes on sliding head lathes
- Centred shank
- The head is equipped with an internal spring system to regulate the pressure of the diamond tip, making it homogeneous on all parts (Fig.1)
- Can be used on workpieces made of different types of materials with hardness up to 63 HRC
- Possibility of placing the diamond tip in different positions to extend the life of the tool

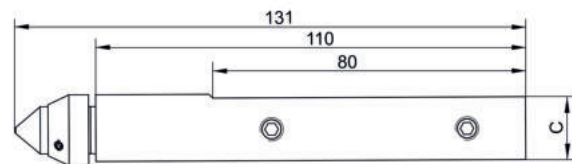

+ Avance Feed

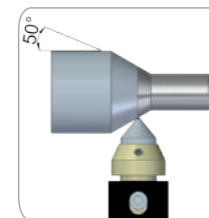
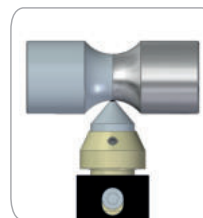
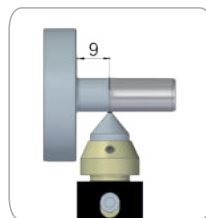
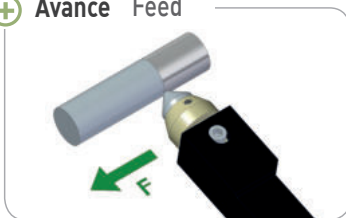

Herramienta Tool						
Código Code	Referencia Reference	Versión Version	Diamante Diamond	C	D	Kg
09120100	HBCD 12	R+L	DT 12	12	16	0.3
09120200	HBCD 16	R+L	DT 12	16	16	0.3

Punta de diamante | Diamond tip

Código Code	Referencia Reference
10010104	DT 12-R0.4
10010108	DT 12-R0.8
10010110	DT 12-R1.0
10010120	DT 12-R2.0





HERRAMIENTAS DE BRUÑO BURNISHING TOOLS



HBUD-P

+ Características

Herramienta diseñada para bruñir en tornos, superficies exteriores de formas variadas

Cara superior del mango alineada con la punta del diamante

Cabeza giratoria con escala graduada (Fig. 1&2)

Cabeza provista de un sistema interno de resorte que regula la presión haciéndola homogénea en todas las piezas (Fig.3)

Utilizable sobre piezas de diferentes tipos de materiales con durezas hasta 63 HRC

Posibilidad de colocar la punta de diamante en diferentes posiciones para prolongar la vida del útil

+ Features

Tool designed for burnishing external diameters of various shapes on sliding head lathes

Centred shank

Rotating head with graduated scale (1&2)

The head is equipped with an internal spring system to regulate the pressure of the diamond tip, making it homogeneous on all parts (Fig.1)

Can be used on workpieces made of different types of materials with hardness up to 63 HRC

Possibility of placing the diamond tip in different positions to extend the life of the tool

+ Avance Feed

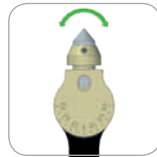
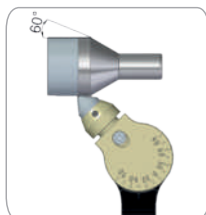
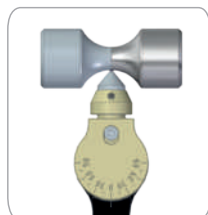
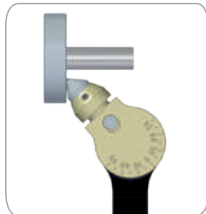

(Fig.1)



(Fig.2)

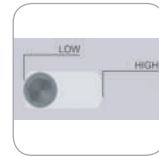

(Fig.3)

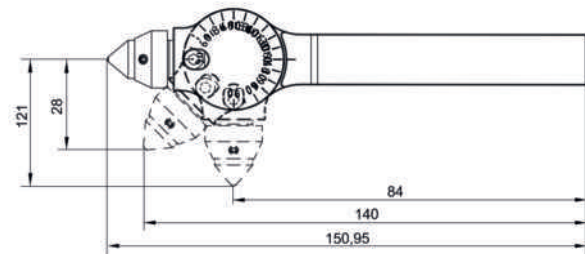
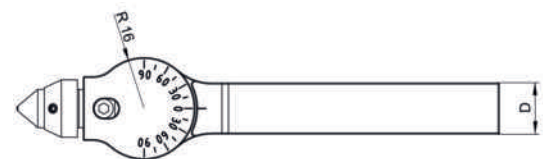
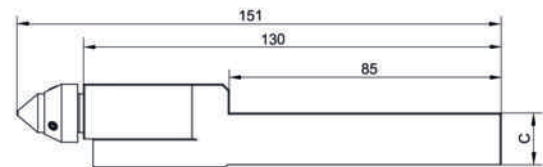
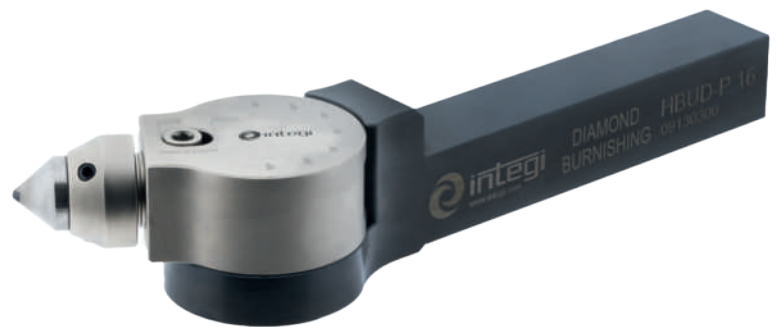

Punta de diamante | Diamond tip

Código Code	Referencia Reference
10010104	DT 12-R0.4
10010108	DT 12-R0.8
10010110	DT 12-R1.0
10010120	DT 12-R2.0



Herramienta Tool						
Código Code	Referencia Reference	Versión Version	Diamante Diamond	C	D	Kg
09130100	HBUD-P 10	R+L	DT 12	10	16	0.3
09130200	HBUD-P 12	R+L	DT 12	12	16	0.3
09130300	HBUD-P 16	R+L	DT 12	16	16	0.4



HERRAMIENTAS DE BRUÑIDO BURNISHING TOOLS



Diamantes de bruñido Burnishing diamonds

+ Características

- Punta de diamante de alto rendimiento
- Para bruñir materiales de hasta HRC 64
- Superficie pulida Ra 0.2
- Varias posiciones de uso mediante indexación de la punta, para alargar la vida de la herramienta

+ Features

- High performance diamond tip
- For burnishing materials up to HRC 64
- Polished surface Ra 0.2
- Various positions of use by indexing the tip, to increase the tool life

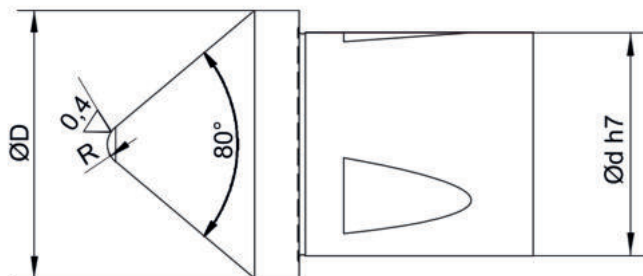

Código Code	Referencia Reference	ØD	Ød	R
10010104	DT 12-R0.4	12	10	0.4
10010108	DT 12-R0.8	12	10	0.8
10010110	DT 12-R1.0	12	10	1.0
10010120	DT 12-R2.0	12	10	2.0



www.integi.com



Autonomía, 5
E-48250 · Zaldibar · Bizkaia · Spain

Tel: +34 943 17 48 00

integi@integi.com



Miembro de / Member of:

