

Hexa Blade

Grooving and parting tool with precision 6 corners

- Grooving and parting tool with high economical 6 corners
- Increased reliability and stability in cutting due to high qualified cutting edge

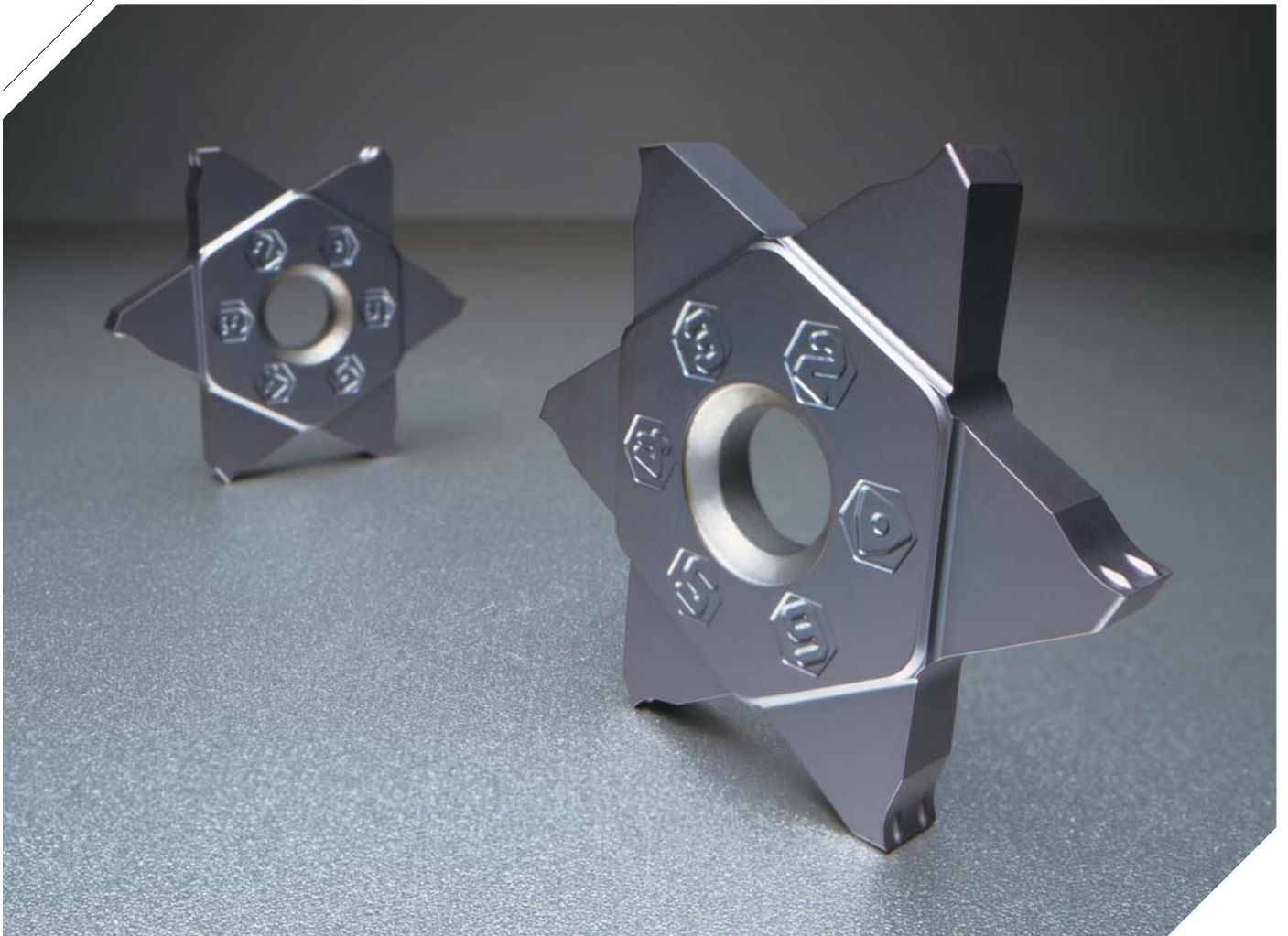

Grooving and parting tool with precision 6 corners

Hexa Blade

KORLOY launched Hexa Blade for precision typed grooving and parting realizing high cost efficiency due to 6 corners.

The exclusive structured **Hexa blade 6 corners insert** provides stable cutting quality with equal clamping dimensions even with corner changes by applying precision manufacturing technology. In addition, bumped chip breaker provides good chip control in various cutting conditions.

The **Hexa Blade holder** ensures long tool life through wide clamping side and strong clamping system with 3-sided clamping. It also provides convenient cutting from easy clamping inserts with various cutting widths on one holder.

» **High cost efficiency**

- 6 cornered insert for grooving and parting

» **Good chip control**

- Increased chip control by bumped chip breaker

» **Regular cutting quality**

- Excellent corner dimension deviation management from precision manufacturing technology

» **High cutting stability**

- Strong clamping system from wide clamping side and 3-sided clamping

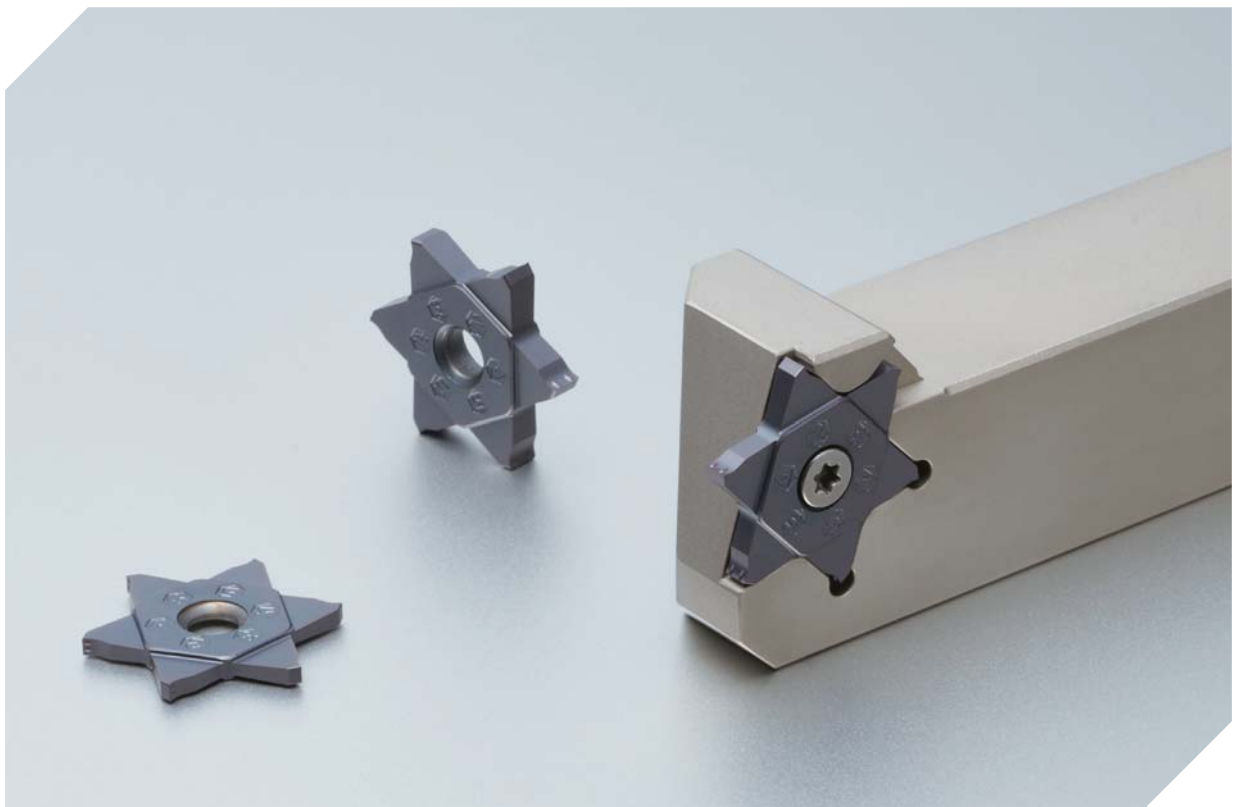

Code system

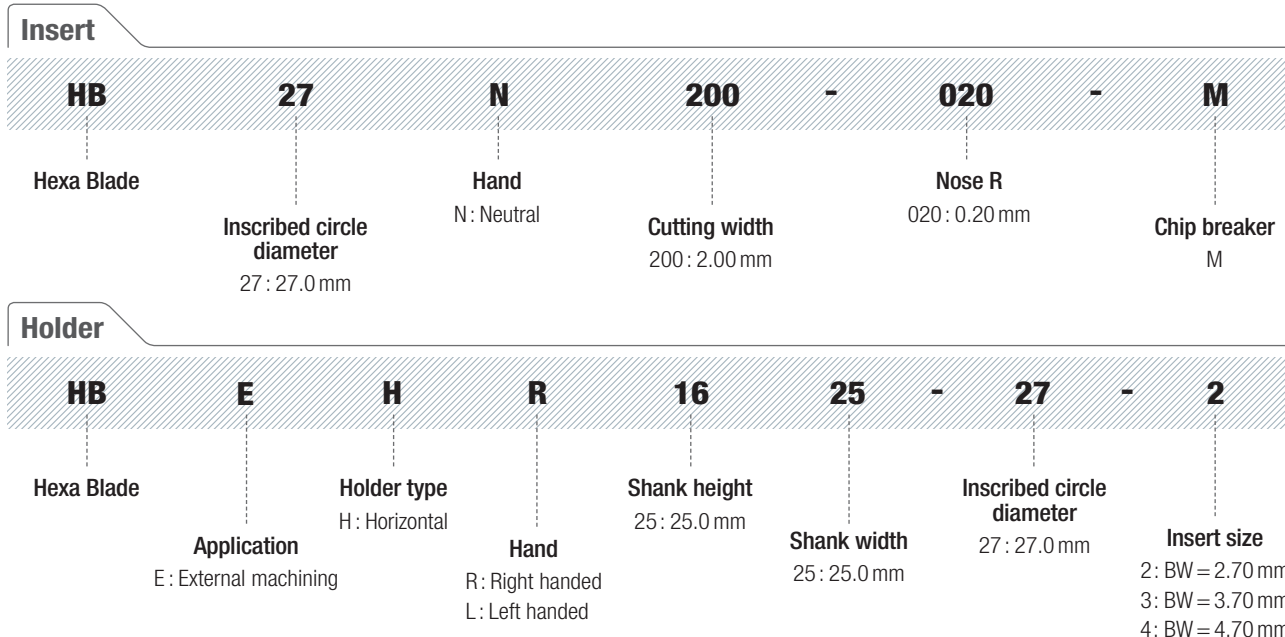

Features

M Chip breaker

- Dot-typed chip breaker general cutting for various workpieces
- Good chip control preventing long chip and chip curling
- Stable cutting even in high feed cutting due to strengthened cutting edge structure

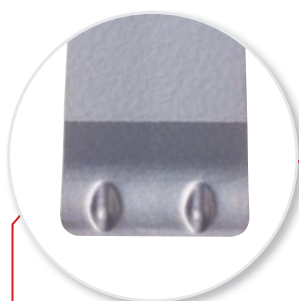

Precision insert

- Superior quality in dimensions
- Excellent corner dimension deviation management
- Equally stable performance

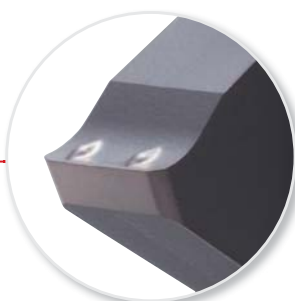

Strong cutting edge

- Increased high feed cutting performance

Wide clamping area

- More stable clamping system
- Strengthen anti-vibration during machining
- Reliable tool life

Neutral hand

- Convenient use with neutral hand

6 cornered insert

- High cost efficiency from multi-corners

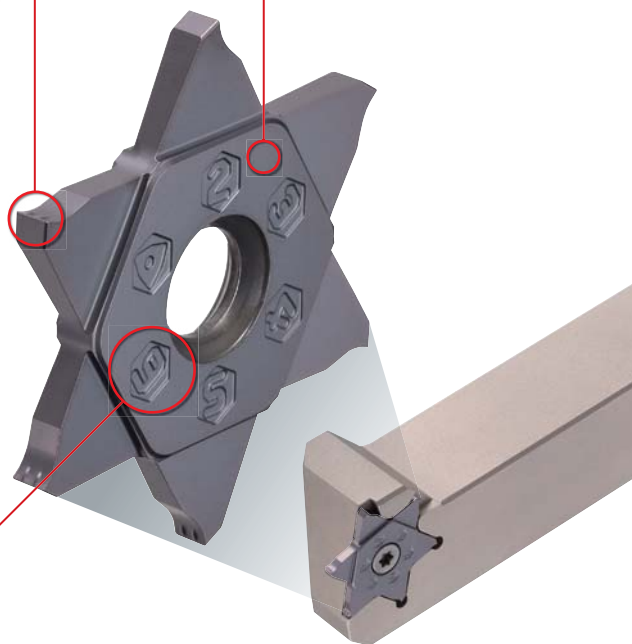

Grade features

PC5300

- PVD coating layer with high hardness and oxidation resistance during machining at high temperature
→ Superior oxidation resistance during machining of steel, cast iron, stainless steel, and heat-resistance alloys
- Ultra fine grain substrate with high toughness and special treatment on the surface
→ Improved welding resistance and chipping resistance

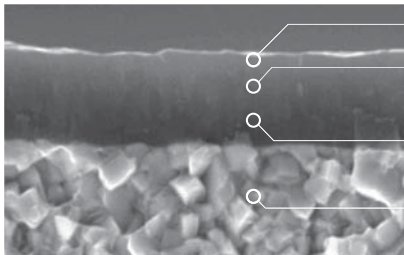

- Coating layer with high surface finish → Superior welding resistance
- Coating layer with high hardness and oxidation resistance during machining at high temperature → Superb wear resistance during machining at high speeds
- Coating layer with high toughness and high adhesive strength → Excellent chipping resistance
- Ultra fine grain substrate with high toughness → Great fracture resistance and stability in machining

- Special treatment on the surface
(Attached pictures if surface of coating layer)

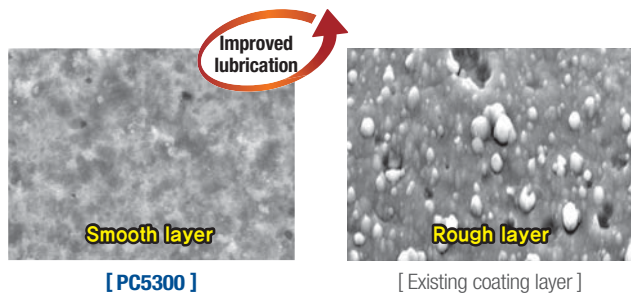

- Coating layer with oxidation resistance during machining at high temperature
(after 900° heat treatment)

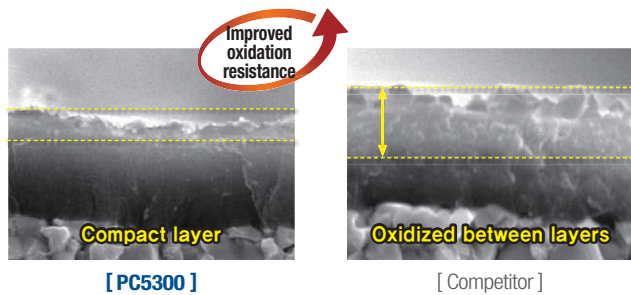

Application range

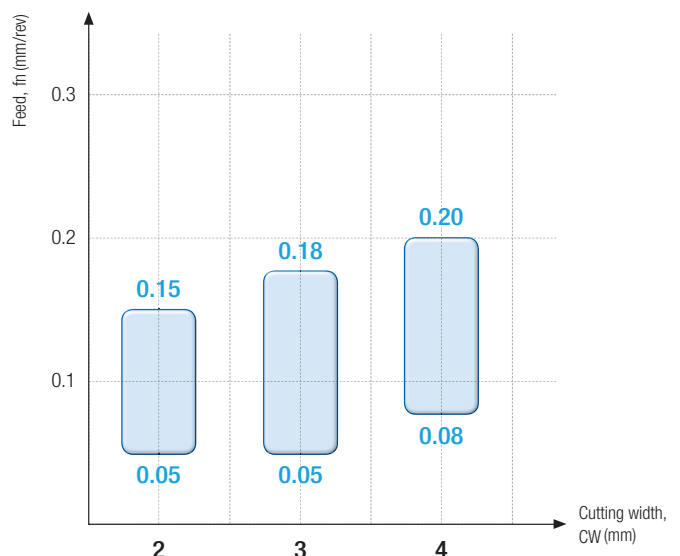
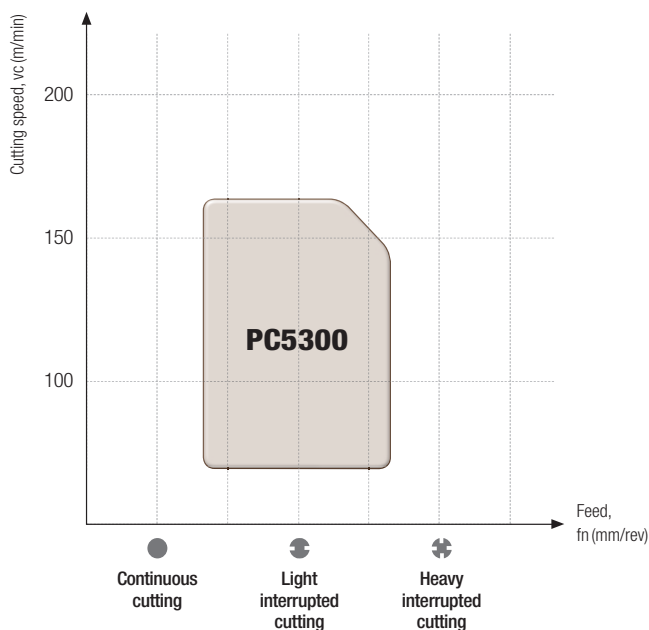

Performance evaluation

Wear resistance

Workpiece Alloy steel (43CrMo4)

Cutting conditions $vc(m/min) = 100$, $fn(mm/rev) = 0.1$, $ap(mm) = 2.5$, wet

Tools **Insert** HB27N200-020-M(PC5300) **Holder** HBEHR2525-27-2

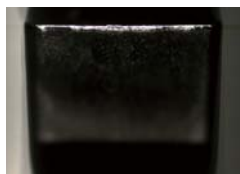

[Hexa Blade]





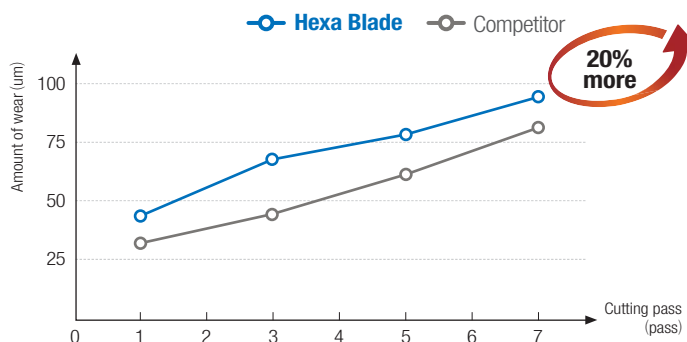

[Competitor]



Cutting width and cutting depth by tools

⊙: 1st recommendation ○: 2nd recommendation

Tools	Cutting width (mm)				No. of edges	Machining				Features
	2	4	6	8		External	Internal	Facing	Parting	
	5	10	20	60						
Cutting depth maximum (mm)										
Hexa Blade 	1.78	4.0			6	⊙				<ul style="list-style-type: none"> Precision type High cost efficient cutting
TB 	1.25	6.0			3	⊙				<ul style="list-style-type: none"> Precision type Optimal for automated machining
K Notch 	0.75	6.3			2	⊙				<ul style="list-style-type: none"> Precision type Strong clamping system
KGT 	1.5	8.0			2	⊙	○	○	⊙	<ul style="list-style-type: none"> For various kinds of cutting For general cutting range
Saw Man-X 	2.0	6.0		60.0	1	○			⊙	<ul style="list-style-type: none"> Various lead angles Minimizing burr

Recommended cutting conditions

ISO	Workpiece			Specific cutting force (N/mm ²)	Brinell hardness (HB)	Grade	C/B	ap (mm)						
	Workpiece materials		ISO			AISI	PC5300		M					
							vc (m/min)		fn (mm/rev)					
P	Unalloyed steel	C = 0.25~0.55%	C35	1035	1600	150	110	0.15	≤ 5.0					
							130	0.12						
							150	0.10						
		C = 0.55~0.80%	C45	1045 1046	1700	170	80	0.15						
							100	0.12						
							120	0.10						
	Low alloy steel	Non-hardened	43CrMo4	4140	1700	180	80	0.15						
							100	0.12						
							120	0.10						
		Hardened and tempered	-	4145	2050	350	50	0.15						
							60	0.12						
							70	0.10						
High alloy steel	Annealed	-	D2	1950	200	60	0.15							
						75	0.12							
						90	0.10							
						M	Austenite series	X5CrNi18-9	304	2000	180	60	0.10	≤ 5.0
												80	0.08	
												100	0.06	
X5CrNiMo17-12-2	316	2000	180	60	0.10									
				80	0.08									
				100	0.06									

P Steel

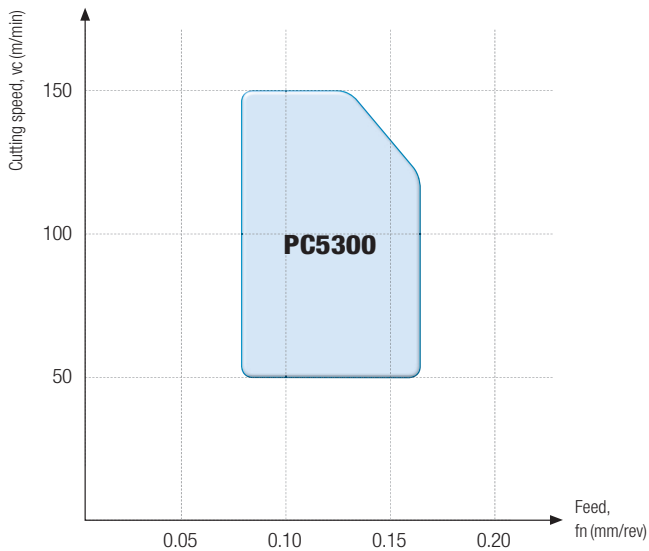

M Stainless steel

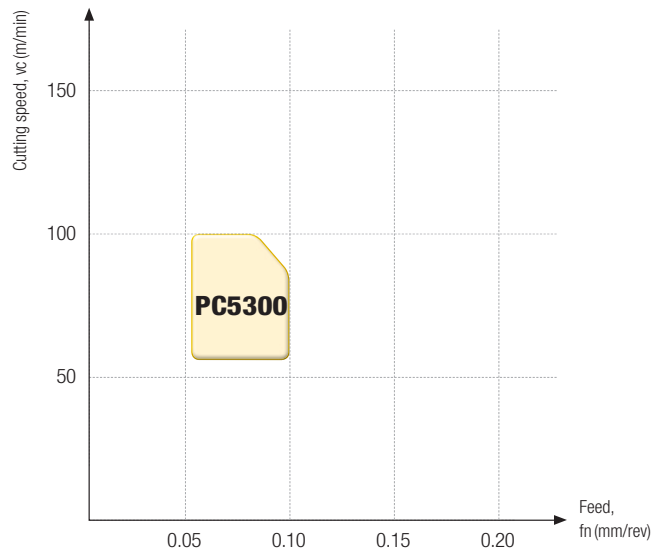

Tool selection guide

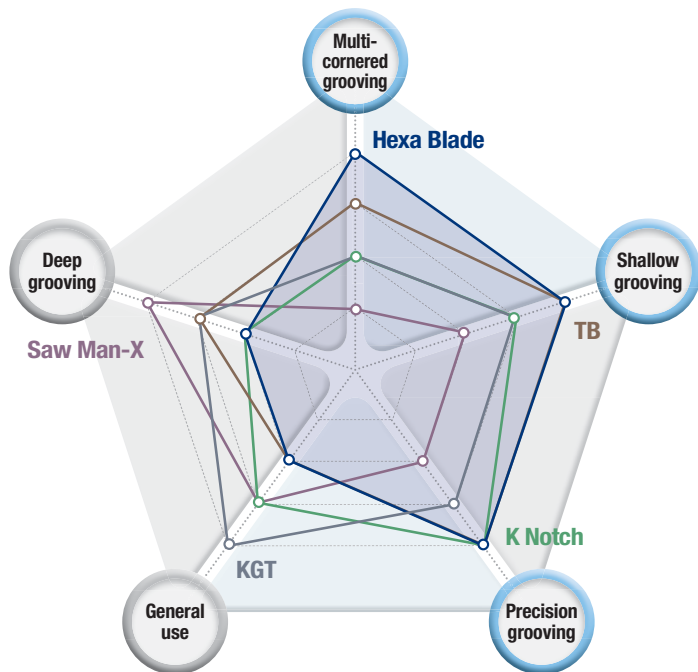

Hexa Blade ^{New}

- Precision typed and 6 cornered insert
- High cost efficiency
- Precision grooving and multi-cornered grooving



TB

- Precision typed and 3 cornered insert
- Optimal for automatic cutting
- Precision grooving



K Notch

- Precision typed and 2 cornered insert
- Strong clamping system
- Precision grooving

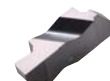

KGT

- 2 cornered insert
- Various applications
- For general use



Saw Man-X ^{New}

- 1 cornered insert
- Optimal for interrupted and high feed parting
- Deep grooving



Tools	Multi-cornered grooving	Shallow grooving	Precision grooving	General use	Deep grooving
Hexa Blade ^{New}	★★★★★	★★★★★	★★★★★	★★	★★
TB	★★★	★★★★★	★★★★★	★★	★★★★
K Notch	★★	★★★	★★★★★	★★★	★★
KGT	★★	★★★	★★★	★★★★★	★★★
Saw Man-X ^{New}	★	★★	★★	★★★	★★★★★

Product using guide

Cutting depth maximum and max. workpiece dia. (mm)		
Cutting depth maximum (CDX)	Max. workpiece dia. (Dmax)	Using guide
5.0	≤ 30	
4.9	≤ 34	
4.8	≤ 38	
4.7	≤ 42	
4.6	≤ 46	
4.5	≤ 58	
4.4	≤ 62	
4.3	≤ 66	
4.2	≤ 70	
4.1	≤ 74	
4.0	≤ 89	
3.9	≤ 93	
3.8	≤ 97	
3.7	≤ 101	
3.6	≤ 105	
3.5	≤ 109	
3.4	≤ 123	
3.3	≤ 127	
3.2	≤ 131	
3.1	≤ 135	
3.0	≤ 147	
2.9	≤ 151	
2.8	≤ 155	
2.7	≤ 159	
2.6	≤ 163	
2.5	≤ 200	
2.4	≤ 200	
2.3	≤ 200	
2.2	≤ 200	
2.1	≤ 200	
2.0	∞	

The diagram shows a grey Hexa Blade tool cutting into a brown workpiece. A dashed circle is drawn around the blade's cutting edge, with an arrow pointing to it labeled 'Max. workpiece dia. (Dmax)'. A red double-headed arrow above the blade indicates the 'Cutting depth maximum (CDX)'.

- ① Hexa Blade enables to cut with maximum 0.5 mm depth of cut. In this case, the maximum workpiece cutting diameter is 30 mm.
- ② In Hexa Blade cutting with 2.0 mm depth of cut, the size of workpiece cutting diameter doesn't matter. If cutting with more than 2.0 mm depth of cut, the applicable workpiece cutting diameter could be different depending on depth of cut.
- ③ If workpiece cutting diameter is bigger than 65 mm, the maximum depth of cut is 4.3 mm. In case of cutting with deeper than 4.3 mm, there could be cutting troubles because the holder touches workpieces.
- ④ If depth of cut is 3.5 mm, the maximum workpiece cutting diameter is 109 mm. If it is bigger than 109 mm, there could be cutting troubles because the holder touches workpieces.

※ Cutting depth maximum and max. workpiece dia. on the chart could be different up to cutting environment.

Insert

Picture	Designation	Coated	Dimensions (mm)				Geometries
		PC5300	CW	RE	BW	IC	
	HB 27N178-018-M	●	1.78	0.18	2.7	27	
	27N185-015-M	●	1.85	0.15	2.7	27	
	27N196-015-M	●	1.96	0.15	2.7	27	
	27N200-020-M	●	2.00	0.20	2.7	27	
	27N200-040-M	●	2.00	0.40	2.7	27	
	27N270-010-M	●	2.70	0.10	3.7	27	
	27N287-020-M	●	2.87	0.20	3.7	27	
	27N300-000-M	●	3.00	0.00	3.7	27	
	27N300-020-M	●	3.00	0.20	3.7	27	
	27N300-040-M	●	3.00	0.40	3.7	27	
	27N374-020-M	●	3.74	0.20	4.7	27	
	27N398-020-M	●	3.98	0.20	4.7	27	
	27N400-040-M	●	4.00	0.40	4.7	27	

●: Stock item

HBEHR



HB

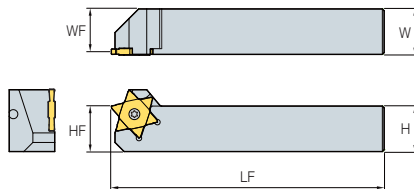

Fig. 1

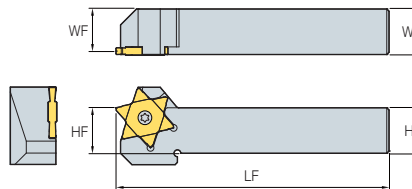
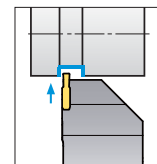

Fig. 2



• R type holder

(mm)

Designation	Stock	CW	H	W	LF	HF	WF	Screw	Wrench	Fig.
HBEHR 2020-27-2	●	1.78 ~ 2.00	20	20	120	20	19.0	PTMA0512D	TW15P	2
2525-27-2	●	1.78 ~ 2.00	25	25	150	25	24.0			1
2020-27-3	●	2.70 ~ 3.00	20	20	120	20	18.5			2
2525-27-3	●	2.70 ~ 3.00	25	25	150	25	23.5			1
2020-27-4	●	3.74 ~ 4.00	20	20	120	20	18.0			2
2525-27-4	●	3.74 ~ 4.00	25	25	150	25	23.0			1

●: Stock item

Cutting depth maximum and max. workpiece dia. (mm)

Cutting depth maximum (CDX)	5.0	4.5	4.0	3.5	3.0	2.5	2.0
Max. workpiece dia. (Dmax)	≤ 30	≤ 58	≤ 89	≤ 109	≤ 147	≤ 200	∞

※ Please refer to the page 8 for the cutting depth maximum and max. workpiece dia. (mm)

⚠ For the safe metalcutting

- Use safety supplies such as protective gloves to prevent possible injury while touching the edge of tools.
- Use safety glasses or safety cover to hedge possible dangers. Inappropriate usage or excessive cutting condition may lead tool's breakage or even the fragment's scattering.
- Clamp the workpiece tightly enough to prevent its movement while its machining.
- Properly manage the tool change phase because the inordinately used tool can be easily broken under the excessive cutting load or severe wear, and it may threat the operator's safety.
- Use safety cover because chips evacuated during cutting are hot and sharp and may cause burns and cuts. To remove chips safely, stop machining, put on protective gloves, and use a hook or other tools.
- Prepare for fire prevention measures as the use of the non-water soluble cutting oil may cause fire.
- Use safety cover and other safety supplies because the spare parts or the inserts can be pulled out due to centrifugal force while high speed machining.



Head Office: Holystar B/D, 326, Seocho-daero, Seocho-gu, Seoul, 06633, Republic of Korea
Tel: +82-2-522-3181 Fax: +82-2-522-3184, +82-2-3474-4744 Web: www.korloy.com E-mail: sales.khq@korloy.com

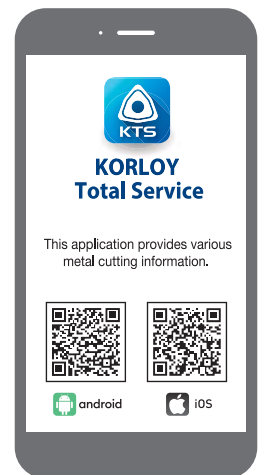

KORLOY AMERICA

620 Maple Avenue, Torrance, CA 90503, USA
Tel: +1-310-782-3800 Toll Free: +1-888-711-0001 Fax: +1-310-782-3885
E-mail: sales.kai@korloy.com

KORLOY INDIA

Plot No. 415, Sector 8, IMT Manesar, Gurgaon 122051, Haryana, India
Tel: +91-124-4391790 Fax: +91-124-4050032
E-mail: sales.kip@korloy.com

KORLOY TURKIYE

Serifali Mahallesi, Burhan Sokak NO: 34
Dudullu OSB/Umraniye/Istanbul, 34775, Turkey
Tel: +90-216-415-8874 E-mail: sales.ktl@korloy.com

KORLOY RUSSIA

Krasiviy Dom office No. 305, Bld. 5, Novovladykinskiy proezd 8, 127106,
Moscow, Russia
Tel: +7-495-280-1458 Fax: +7-495-280-1459 E-mail: sales.krc@korloy.com

KORLOY FACTORY INDIA

Plot No. 415, Sector 8, IMT Manesar, Gurgaon 122051, Haryana, India
Tel: +91-124-4391790 Fax: +91-124-4050032
E-mail: pro.kim@korloy.com

KORLOY EUROPE

Gablonzer Str. 25-27, 61440 Oberursel, Germany
Tel: +49-6171-277-83-0 Fax: +49-6171-277-83-59
E-mail: sales.keg@korloy.com

KORLOY BRASIL

Av. Aruana 280, conj.12, WLC, Alphaville, Barueri,
CEP06460-010, SP, Brasil
Tel: +55-11-4193-3810 E-mail: sales.kbl@korloy.com

KORLOY CHILE

Av. Providencia 1650, Office 1009, 7500027
Providencia-Santiago, Chile
Tel: +56-229-295-490 E-mail: sales.kcs@korloy.com

KORLOY MEXICO

Calle R. M. Clemencia Borja Taboada 522, Jurica Acueducto,
76230 Juriquilla, Qro., Mexico
Tel: +52-442-673-7388 E-mail: sales.kml@korloy.com

