

Heptagonal face mill with 14 double-sided corners

RM14



KORLOY
TECH-NEWS



- Economical face mill with 14 double-sided corners
- Minimized chattering of workpiece due to minimum lead angle and sharp cutting edge
- Reduced cutting resistance and improved chip emissions by high helix angle application

Heptagonal face mill with 14 double-sided corners

RM14

In the various industries including automotive components business, workpieces are manufactured with casting for easy-producing complicated shapes and lowering cost. However, due to the characteristic of casting manufacturing, facing is necessary on each uneven facing surface for assembling. In casting machining, complicated shapes of workpiece and uneven surface creates low clamping force, chattering, unstable tool life, bad surface finish and even shortening life of equipment.

KORLOY launches the double-sided face mill, RM14 to solve those troubles in machining.

RM14 designed with the maximum lead angle, 51° of heptagonal shape reduces cutting load and

chattering comparing to the conventional face mill with lead angle, 45° . Its strong wedge type clamping system ensures stable tool life even in poor cutting conditions.

In addition, there are two types of RM14 insert which are neutral (flat cutting edge) and right-handed (helix cutting edge) and it is possible for both of them to clamp to a single holder. The thicker RM14 insert with sharp cutting edge ensures good performance and stability and its optimal grade realizes long tool life.

RM14 is an economic tool using maximum 14 corners and ensures stable machining and high productivity.

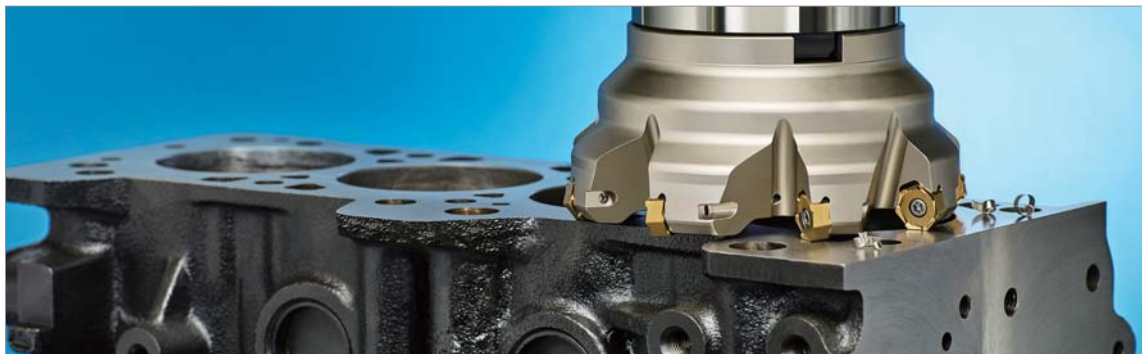

Good performance

- Less cutting load due to high rake and high helix

Improved surface finish

- Less chattering due to lead angle of 51°
- Good chip evacuation

Stable tool life

- High rigidity from thick insert

Stable clamping system

- Wide supporting area and acute angled clamping structure

Application range



Ductile cast iron (500-7/600-3)

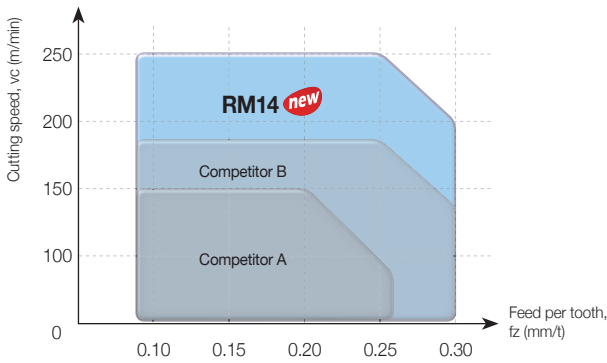

Stainless steel (X5CrNiMo17-12-2)

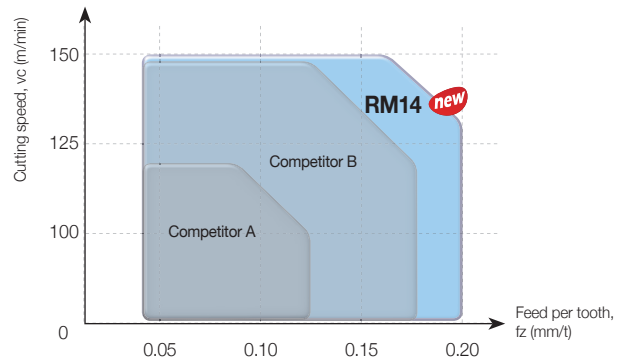

Heat resistance stainless steel [1.4849 (DIN)]

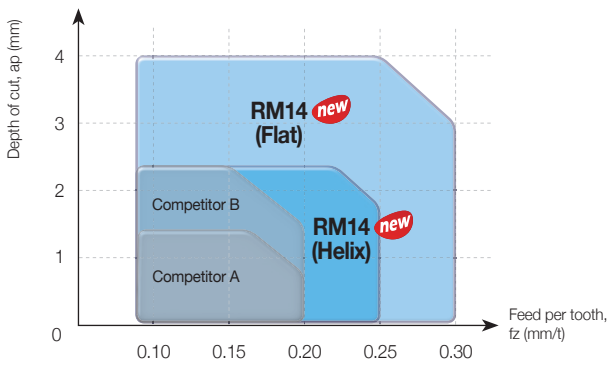

Code system

【Cutter type】

RM	14	X	C	M	080	R	-	27	-	7	-	XN06
Rich Mill	Approach angle X: special		Type C: Cutter	Arbors type M: Metric A: Inch None: Asia	Coolant type & hand R: Coolant, right handed NR: No coolant, left handed			No. of teeth 7: 7 teeth		Insert XN06: XNMX06		
No. of edges 14: 14 edges		Tool Dia. 080: Ø80 mm		Internal 27: Ø27 mm								

Insert features



- Wide supporting area of insert ensures stable clamping system.
- High rake angle cutting edge reduces cutting load and increases chip evacuation.
- Thicker insert realizes stability in machining.

Wider clamping area

- More stable machining

High helix cutting edge

- Better machinability
- Less cutting load

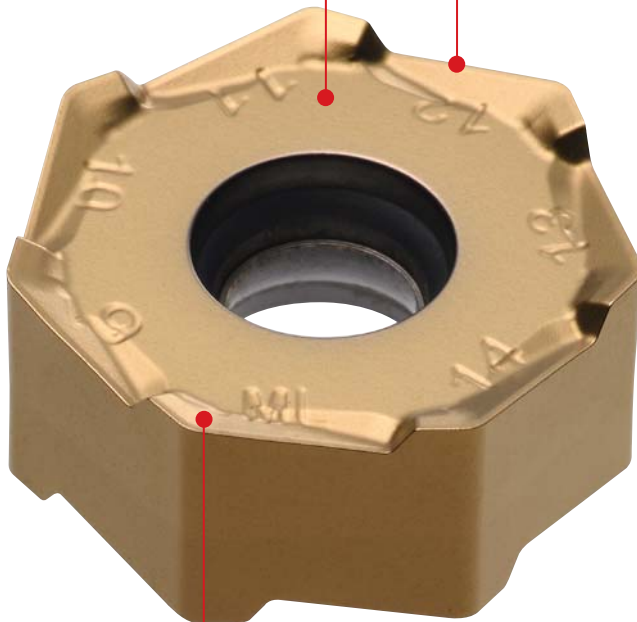

High rake angle chip breaker

- Less cutting load
- Better chip evacuation



Thicker insert

- High cutting edge strength

Features of insert per types

	Type	Features	Application range
Flat		<ul style="list-style-type: none"> • Neutral type • Flat cutting edge 	<ul style="list-style-type: none"> • 1st recommended for heat resistant stainless steel machining • Generally applied in various machining • Applicable for both right handed and left handed
Helix		<ul style="list-style-type: none"> • Right handed type • High helix cutting edge 	<ul style="list-style-type: none"> • 1st recommended for cast iron machining • Applicable for stainless steel machining with less than 3 mm depth of cut • For high speed and high feed machining

Cutter features



- The biggest heptagonal lead angle reduces chatter in machining.
- Wedge type clamping system ensures stable clamping.
- Stepped machining is available without interruption of side wall of insert.



The biggest heptagonal lead angle

- Reduced workpiece chattering by reducing axial force

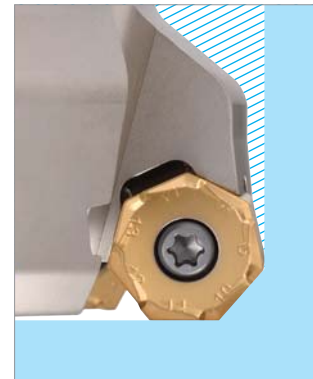

Preventing interruption of side wall

- Prevented interruption of side wall by using the most number of corners in deep facing (heptagonal 14 double-sided corners)

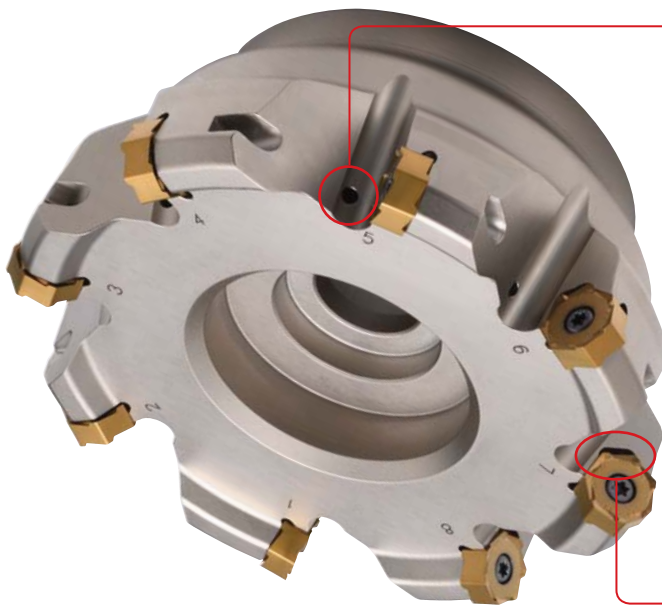

Internal coolant system

- Improved chip evacuation
- Increased tool life due to cooling insert



Wedge clamping system

- Stable clamping system with an acute angle structure



【Stable machining】



[RM14]



[Competitor]

- **Workpiece** Ductile cast iron (500-7)
- **Cutting conditions** vc (m/min) = 150, fz (mm/t) = 0.25, ap (mm) = 3, ae (mm) = 50, wet
- **Tools**
 - Insert** XNMX0606XNR-ML (PC6510)
 - Holder** RM14XCM080R-27-6-XN06

Stable machining with RM14 increases chipping resistance

▶ Longer tool life comparing to competitor's tool

Wear resistance

- **Workpiece** Ductile cast iron (600-3)
- **Cutting conditions** vc (m/min) = 250, fz (mm/t) = 0.2, ap (mm) = 2, wet
- **Tools** **Insert** XNMX0606XNR-ML (PC6510) **Holder** RM14XCM080R-27-6-XN06

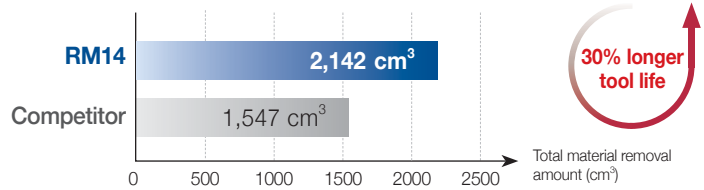
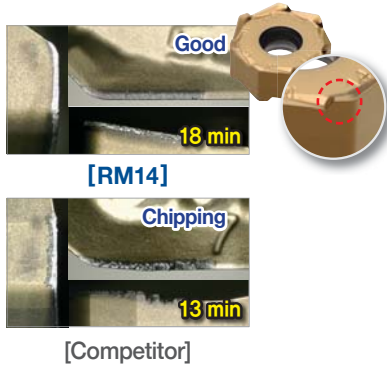

- Material removal rate Q (cm³/min): 119
- Cutting time (min): 18

Wear resistance

(*: DIN)

- **Workpiece** Heat resistance stainless steel (1.4849*)
- **Cutting conditions** vc (m/min) = 100, fz (mm/t) = 0.2, ap (mm) = 2, dry
- **Tools** **Insert** XNMX060608-ML (PC9540) **Holder** RM14XCM080R-27-6-XN06

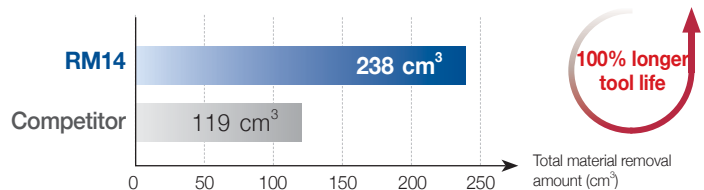
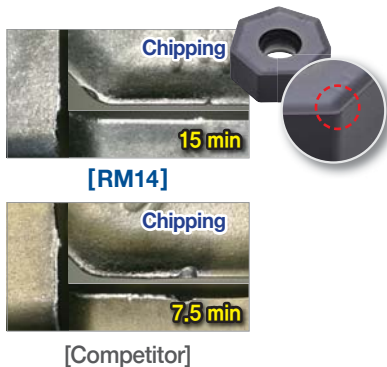

- Material removal rate Q (cm³/min): 15.9
- Cutting time (min): 15

Surface finish

- **Workpiece** Stainless steel (X5CrNiMo17-12-2)
- **Cutting conditions** vc (m/min) = 100, fz (mm/t) = 0.15, ap (mm) = 2, ae (mm) = 50, dry
- **Tools** **Insert** XNMX0606XNR-ML (PC9540) **Holder** RM14XCM080R-27-6-XN06



[RM14]



[Competitor]

Face mill tool selection guide



RM16

- The most no. of corners



RM14 ^{new}

- Less cutting load
- Multi-functional machining (preventing interruption in deep machining)



RM14

RM8

RM16

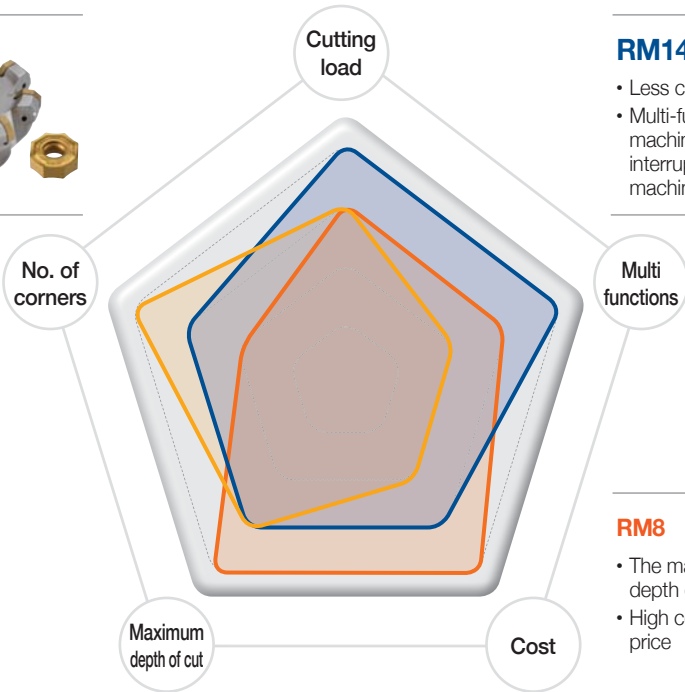

RM8

- The maximum depth of cut
- High competitive price



Tools	Cutting load	Multi functions	Cost	Maximum depth of cut	No. of corners
RM14 ^{new}	★★★★	★★★★	★★★	★★★	★★★
RM8	★★★	★★★	★★★★	★★★★	★★
RM16	★★★	★★	★★	★★★	★★★★

Recommended cutting conditions

ISO	Workpiece	ISO (DIN)*	AISI	KS	HB	Grade	Cutting conditions					
							Helix			Flat		
							vc (m/min)	fz (mm/t)	ap (mm)	vc (m/min)	fz (mm/t)	ap (mm)
M	Austenite	X5CrNi18-9 X5CrNiMo17-12-2	304 316	STS304 STS316	160-180	PC9540 (PC5300)	80-160	0.3-0.05	1-3	90-150	0.25-0.05	1-3
	Heat resistance stainless steel	(1.48□□)*	-	-	160-200	PC9540 (PC5300)	60-100	0.2-0.05	1-2	60-100	0.25-0.05	1-3
K	Gray cast iron	250 (GG 25)*	No 35 B	GC250	180-240	NCM535 (PC6510)	200-300	0.3-0.1	2-3	200-300	0.25-0.1	2-3
	Ductile cast iron	500-7 (GGG 50)*	80-55-06	GCD500	150-230	PC6510 (PC5300)	110-230	0.3-0.1	2-3	150-200	0.3-0.1	2-3
		600-3 (GGG 60)*	-	GCD600	170-270	PC6510 (PC5300)	85-200	0.25-0.15	2-3	150-200	0.25-0.15	2-3

Recommended grade and cutting edge

(● : 1st recommendation)

Type		Recommended grade and cutting edge by workpiece							
		M				K			
		Austenitic stainless steel		Heat resistance stainless steel		Gray cast iron		Ductile cast iron	
		Type	Grade	Type	Grade	Type	Grade	Type	Grade
Flat		-	● PC9540 ○ PC5300 ○ PC5400	●	● PC9540 ○ PC5300 ○ PC5400	-	○ PC6510 ○ PC5300 ● NCM535	-	● PC6510 ○ PC5300 ○ NCM535
		●	● PC9540 ○ PC5300 ○ PC5400	-	● PC9540 ○ PC5300 ○ PC5400	●	○ PC6510 ○ PC5300 ● NCM535	●	● PC6510 ○ PC5300 ○ NCM535

Universal grade PC5300

- PVD coating layer with high hardness and oxidation resistance during machining at high temperature
→ Superior oxidation resistance during machining of steel, cast iron, stainless steel, and heat-resistant alloys
- Ultra fine grain substrate with high toughness and special treatment on the surface
→ Improved welding resistance and chipping resistance

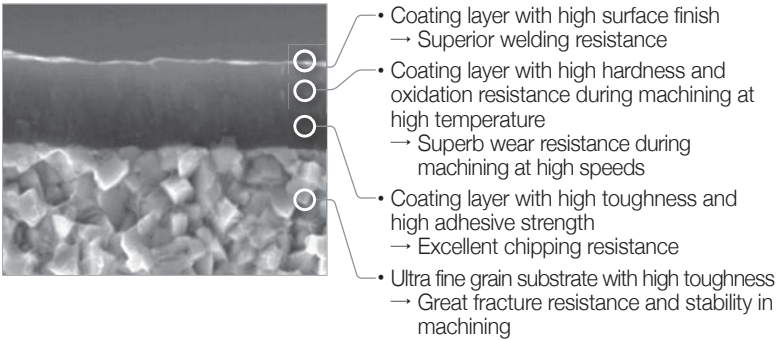

[Coating layer with oxidation resistance during machining at high temperature (after 900°C heat treatment)]

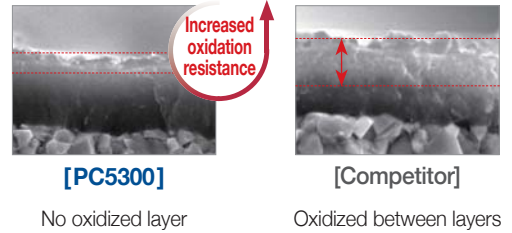

Universal grade PC5400

- Coating layer with excellent lubrication → Improved wear resistance and surface roughness at low speed machining or machining of deposited materials and mild steel
- Ultra fine and high toughness substrate and high toughness coating layer → Stable machinability due to increased chipping resistance and fracture resistance

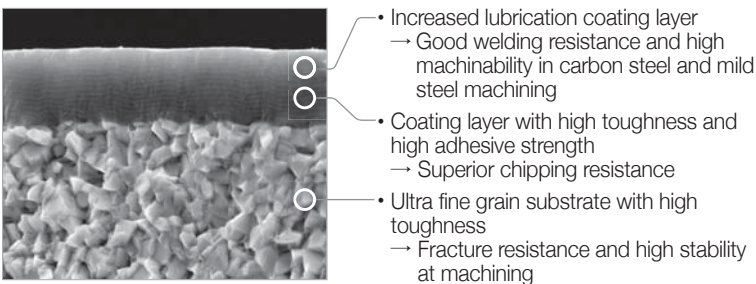

[Surface of the layer rubbed with C45 ball]

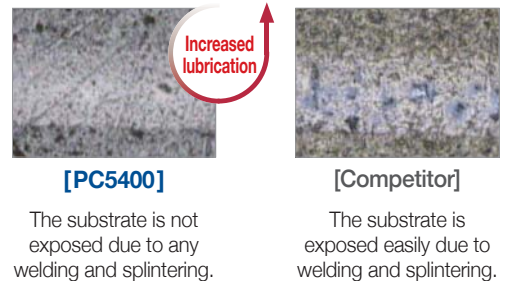

Milling grade for stainless steel machining PC9540 new

- Optimally designed PVD grade in medium to roughing of stainless steel milling and high interrupted machining
- Longer tool life due to increased fracture resistance from high toughness substrate controls spreading of cracks
- Good machinability in hard-to-cut material machining due to applying new PVD oxide film with oxidation resistance and heat resistance
- Stable machining preventing welding and chipping from special coating layer treatment technology

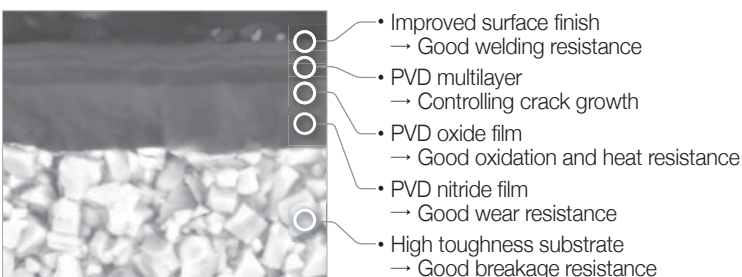

[New PVD oxide film (Comparison of thermal conductivity)]

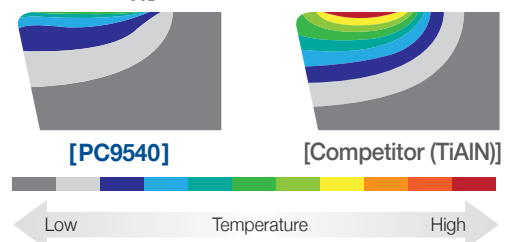

Grade features



Milling grade for cast iron machining **New PC6510** new

- Optimal PVD coating for universal cast iron machining controls fracture due to thermal crack.
- Surface treatment technology controls welding and compression of chip on the insert surface.
- High productivity and stable tool life are ensured.

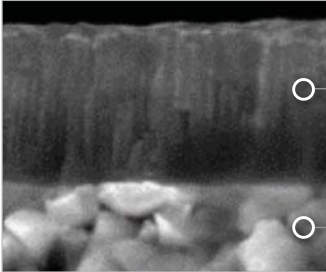

- TiAlN coating layer with high wear resistance and toughness increases stability in machining.
- The optimal substrate with wear resistance and fracture resistance in cast iron machining ensures stable tool life.

[Applied surface treatment technology]

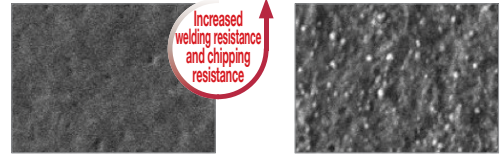

[New PC6510]

[PC6510]

Grade selection guide

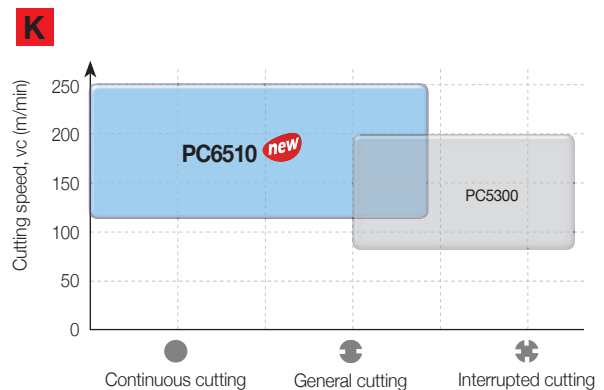
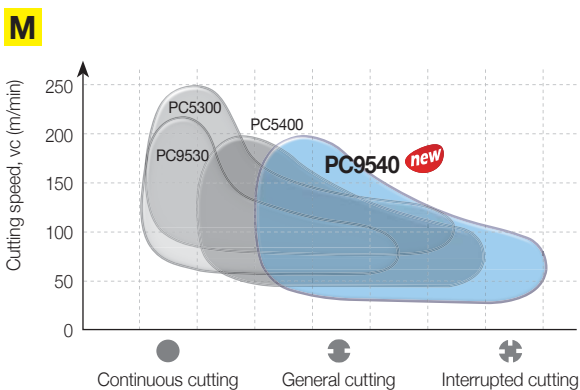

Workpiece	Machining types	Grade	Recommended cutting speed (m/min)	ISO	Application range
M Stainless steel	Continuous cutting	PC5300	130 (100-160)	M30	PC5300
	Interrupted cutting	PC5400	120 (95-155)	M40	PC5400
		PC9540 <small>new</small>	110 (80-140)	M50	PC9540 <small>new</small>
K Cast iron	Continuous cutting	PC6510 <small>new</small>	180 (140-230)	K10	PC6510 <small>new</small>
	Interrupted cutting	PC5300	145 (110-180)	K20	PC5300
		PC5400	125 (85-160)	K30	PC5400

Application range





M 【Turbo charger turbine housings】

(*: DIN)

Type	Finishing	Medium cutting to roughing	Highly interrupted cutting
ISO	M25 - M30	M40	M40
Recommended grade	PC5300, PC9530	PC9540	PC9540
Workpiece	Heat resistance stainless steel (1.48□□)*	Heat resistance stainless steel (1.48□□)*	Heat resistance stainless steel (1.48□□)*
Machining type	Wet machining with low depth of cut on the rough machined part	Dry machining with high depth of cut on the wide machined part	Unstable machining with high and frequent interruption
Machined part			

K 【Cylinder blocks】

ISO	General cutting	Multi-purpose	High interruptions
Recommended grade	New PC6510	New PC6510	PC5300
Workpiece	Gray cast iron, nodular graphite cast iron (ductile cast iron)	Gray cast iron, nodular graphite cast iron (ductile cast iron)	Gray cast iron, nodular graphite cast iron (ductile cast iron)
Machining type	General cutting for wide areas	Multi-purpose cutting for various shapes	Highly interrupted and unstable cutting
Machined part	Top & Bottom face 	Front & Rear face 	Bosses 

Cutting performance



Ductile cast iron (GCD450)

- **Workpiece use** Bed plate
- **Cutting conditions** vc (m/min) = 247, fz (mm/t) = 0.22, ap (mm) = 1, wet
- **Tools** **Insert** XNMX060608-ML (PC6510) **Holder** RM14XCM125R-40-10-XN06

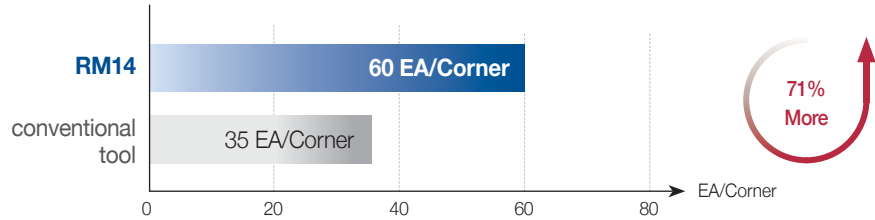

► 71% longer tool life than conventional tool's

Ductile cast iron (GCD450)

- **Workpiece use** Bed plate
- **Cutting conditions** vc (m/min) = 200, fz (mm/t) = 0.16, ap (mm) = 2, wet
- **Tools** **Insert** XNMX0606XNR-ML (PC6510) **Holder** RM14XCM100R-32-10-XN06

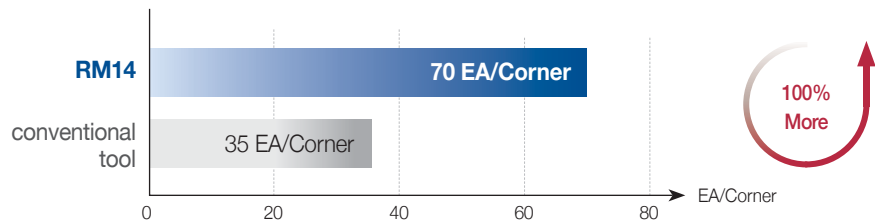

► 100% longer tool life than conventional tool's

Insert

Inserts	Designation	Dimensions (mm)						Coated					Geometries
		l	d	t	r	d _i	a	NCM535	PC6510	PC9540	PC5300	PC5400	
	XNMX0606XNR-ML	6.7	14.0	6.5	0.8	4.6	1.0	●	●	●	●	●	
	XNMX060608-ML	6.7	14.0	6.0	0.8	4.6	-			●	●	●	

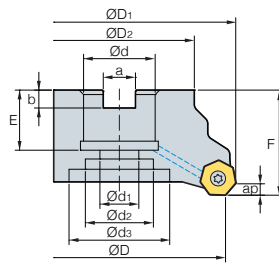

Fig. 1

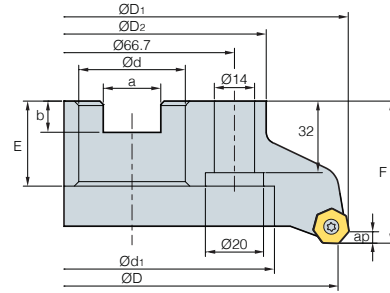

Fig. 2



AA
51°

• AR: -6°
• RR: -9°

(mm)

Designation	Stock	⊙	ØD	ØD1	ØD2	Ød	Ød1	Ød2	Ød3	a	b	E	F	ap	kg	Available inserts	Fig.
RM14XCM 050R-22-5-XN06	●		50	58.6	42	22	11	18	-	10.4	6.3	21	40	3.5	0.34	XNMX06	1
050R-22-6-XN06	●		50	58.6	42	22	11	18	-	10.4	6.3	21	40	3.5	0.34		1
063R-22-6-XN06	●		63	71.6	42	22	11	18	-	10.4	6.3	21	40	3.5	0.51		1
063R-22-8-XN06	●		63	71.6	42	22	11	18	-	10.4	6.3	21	40	3.5	0.58		1
080R-27-6-XN06	●		80	88.6	57	27	14	20	35	12.4	7.0	23	50	3.5	0.98		1
080R-27-8-XN06	●		80	88.6	57	27	14	20	35	12.4	7.0	23	50	3.5	1.08		1
080R-27-10-XN06	●		80	88.6	57	27	14	20	35	12.4	7.0	23	50	3.5	1.07		1
100R-32-10-XN06	●		100	108.6	67	32	18	26	42	14.4	8.0	25	63	3.5	1.60		1
100R-32-12-XN06	●		100	108.6	67	32	18	26	42	14.4	8.0	25	63	3.5	1.58		1
125R-40-12-XN06	●		125	133.6	90	40	22	32	54	16.4	9.0	29	63	3.5	3.43		1
125R-40-14-XN06	●		125	133.6	90	40	22	32	54	16.4	9.0	29	63	3.5	3.40		1
160NR-40-16-XN06	●		160	168.6	110	40	90	-	-	16.4	9.0	32	63	3.5	4.86		2
160NR-40-18-XN06	●		160	168.6	110	40	90	-	-	16.4	9.0	32	63	3.5	4.84		2

※ In applying XNMX060608-□□, Max. ap = 4.8 mm

●: Stock item None: Order made

Available inserts



XNMX-ML



XNMX-ML

Designation	Coated				
	NCM535	PC6510	PC9540	PC5300	PC5400
XNMX 0606XNR-ML	●	●	●	●	●
060608-ML			●	●	●

Available arbors

Designation	Ød	Available arbors
RM14XCM 050R	22	BT□□-FMC22-□□
063R		
080R	27	BT□□-FMC27-□□
100R	32	BT□□-FMC32-□□
125R	40	BT□□-FMC40-□□
160R		

Parts

Specification	Screw	Wrench
Ø50~Ø160	FTKA0412B	TW15S



www.korloy.com



Holystar B/D, 1350, Nambusunhwan-ro, Geumcheon-gu, Seoul, 08536, Korea
Tel : +82-2-522-3181 Fax : +82-2-522-3184, +82-2-3474-4744 Web : www.korloy.com E-mail : sales.khq@korloy.com

KORLOY AMERICA

620 Maple Avenue, Torrance, CA 90503, USA
Tel : +1-310-782-3800 Toll Free : +1-888-711-0001 Fax : +1-310-782-3885
E-mail : sales.kai@korloy.com

KORLOY INDIA

Plot No. 415, Sector 8, IMT Manesar, Gurgaon 122051, Haryana, India
Tel : +91-124-4391790 Fax : +91-124-4050032
E-mail : sales.kip@korloy.com

KORLOY TURKEY

Orucreis Mah. Vadi Cad. No: 108 Istanbul Ticaret Sarayi
Kat 5 No: 318 Giyimkent Sitesi-Esenler/Istanbul, Turkey
Tel : +90-212-438-5197 E-mail : sales.ktl@korloy.com

KORLOY RUSSIA

Krasivy Dom office No. 305, Bld. 5, Novovladykinskiy proezd 8, 127106,
Moscow, Russia
Tel : +7-495-280-1458 Fax : +7-495-280-1459 E-mail : sales.krc@korloy.com

KORLOY FACTORY QINGDAO

Ground Dongjing Road 56(B) District Free Trade Zone. Qingdao, China
Tel : +86-532-86959880 Fax : +86-532-86760651
E-mail : pro.kfq@korloy.com

KORLOY EUROPE

Gablونzer Str. 25-27, 61440 Oberursel, Germany
Tel : +49-6171-277-83-0 Fax : +49-6171-277-83-59
E-mail : sales.keg@korloy.com

KORLOY BRASIL

Av. Aruana 280, conj.12, WLC, Alphaville, Barueri,
CEP06460-010, SP, Brasil
Tel : +55-11-4193-3810 E-mail : sales.kbl@korloy.com

KORLOY CHILE

Av. Providencia 1650, Office 1009, 7500027
Providencia-Santiago, Chile
Tel : +56-229-295-490 E-mail : sales.kcs@korloy.com

KORLOY MEXICO

Queretaro, Mexico
E-mail : sales.kml@korloy.com

KORLOY FACTORY INDIA

Plot No. 415, Sector 8, IMT Manesar, Gurgaon 122051, Haryana, India
Tel : +91-124-4391790 Fax : +91-124-4050032
E-mail : pro.kim@korloy.com