

Hexa Blade

Grooving and Parting tool with precision 6 corners

- Grooving and Parting tool with high economical 6 corners
- Increased reliability and stability in cutting due to high qualified cutting edge



Hexa Blade

KORLOY has launched the Hexa Blade, a precision insert grooving and cutting processing that provides high economic efficiency with its 6-cornered design.

The uniquely shaped 6-corner Hexa Blade applies precision manufacturing technology, ensuring consistent assembly dimension even when changing corners, thereby guaranteeing stable processing quality.

The **Hexa Blade 19** insert, for automatic lathe, optimizes precision machining with a newly developed coating, delivering excellent precision machining performance and provides superior fracture resistance and surface finish quality.

The **Hexa Blade 27** insert's bumped chip breaker provides outstanding chip control in various machining process.

The wide cutting face and three-sided clamping system of the Hexa Blade holder offer stable clamping and enhance tool life under various machining conditions. One holder can easily mount various inserts on the clamping side with a screw, ensuring excellent user convenience.

The high-pressure coolant hole of the Hexa Blade holder delivers focused spray of coolant on the cutting edge, maximizing cooling effects and chip control which provides outstanding productivity.

» **High cost efficiency**

- 6 cornered insert for Grooving and Parting

» **Excellent Machining Performance**

- Achieves superior surface finish with sharp cutting edges (HB19)
- Improves chip control with bumped chip breaker (HB27)

» **Regular cutting quality**

- Excellent corner dimension deviation management from precision manufacturing technology

» **High cutting stability**

- Strong clamping system from wide clamping side and 3-sided clamping

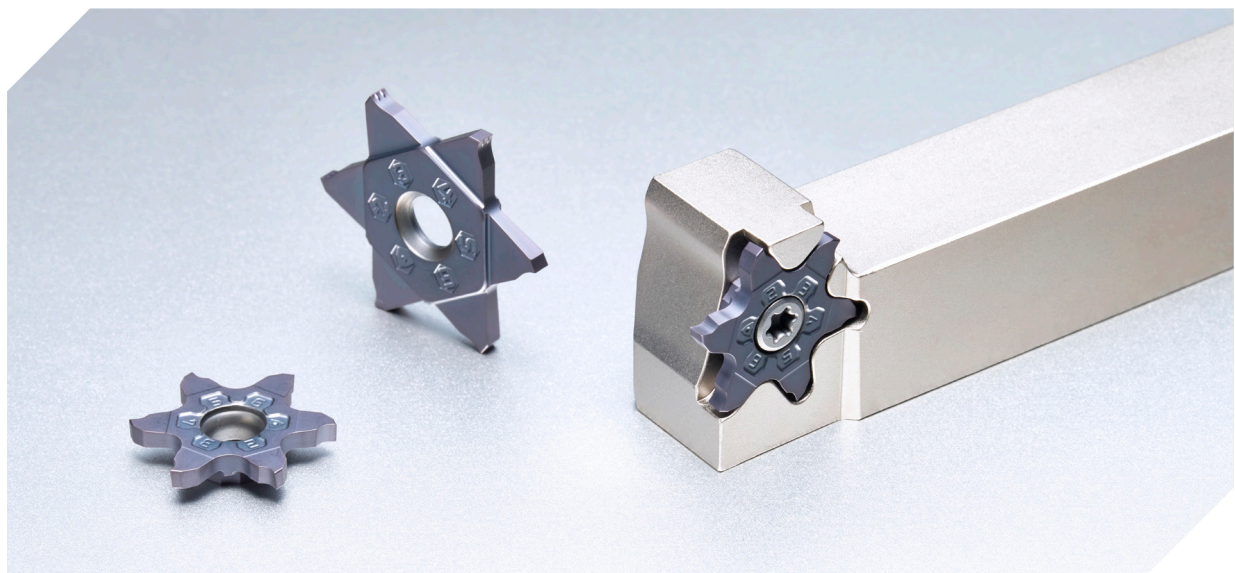



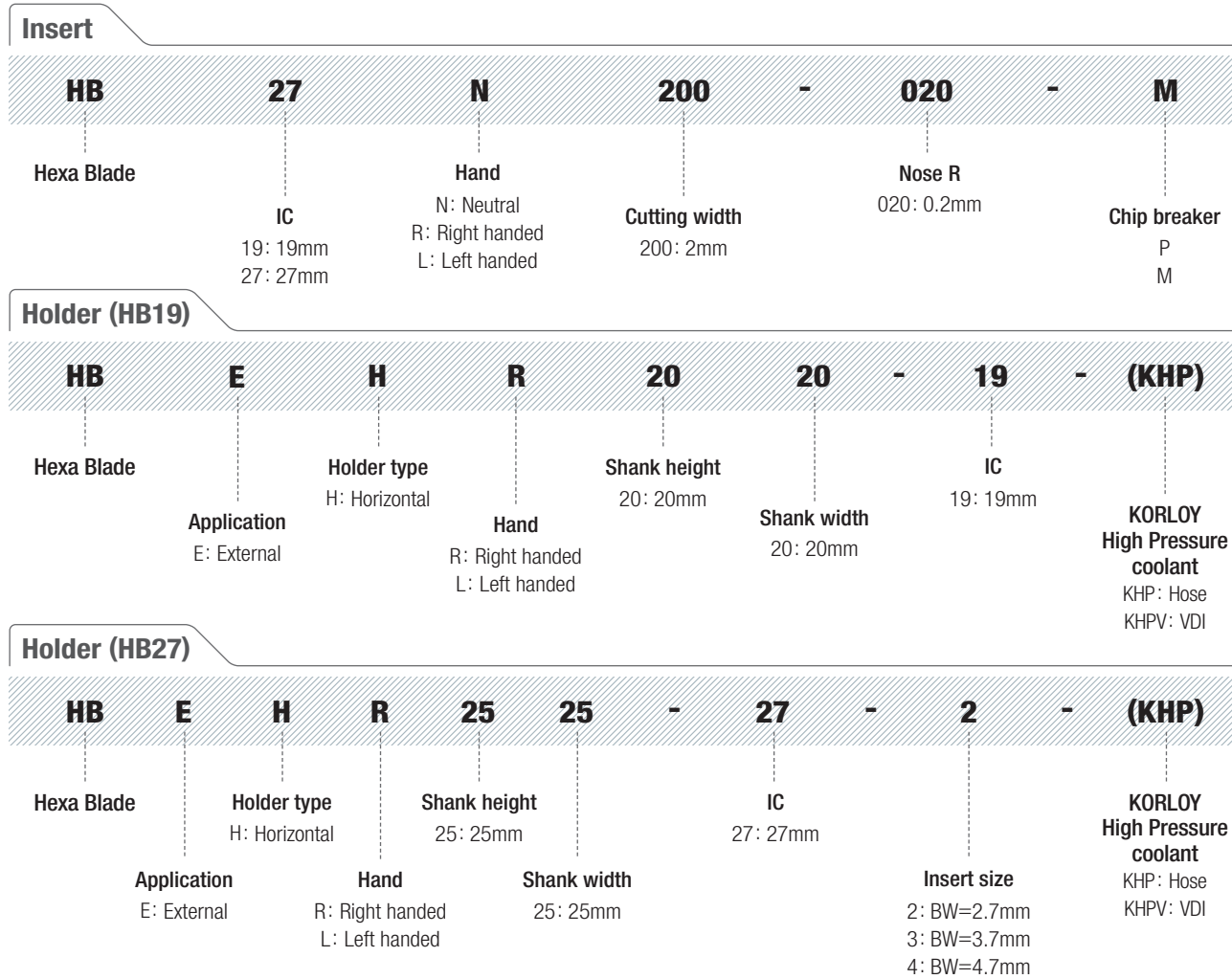

Code system



* IC : Inscribed circle diameter

Cutting width and cutting depth by tools

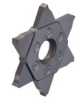
⊙: 1st recommendation ○: 2nd recommendation

Tool	Cutting width (mm)				No. of edges	External cutting				Feature
	2	4	6	8		Grooving	Cutting	Turning	Copying	
	5	10	20	60						
Cutting depth maximum (mm)										
Hexa Blade 19  	0.5	3.18			6	⊙	○		○	<ul style="list-style-type: none"> Precision Grade (Sharp Edge) Offers high economic efficiency Optimized for automated machining
Hexa Blade 27 	1.78	4			6	⊙	○	○		<ul style="list-style-type: none"> Precision Grade (C/B Type) High economic efficiency Excellent chip control
TB 3, 4 	1.25	4.5			3	⊙	○	○		<ul style="list-style-type: none"> Precision Grade (Sharp Edge, C/B Type) Optimized for automated machining
TB 5 	1.25	4.5			3	⊙	⊙	○	○	<ul style="list-style-type: none"> Precision Grade (Sharp Edge, C/B Type) Excellent chip control

✔ Tool selection guide

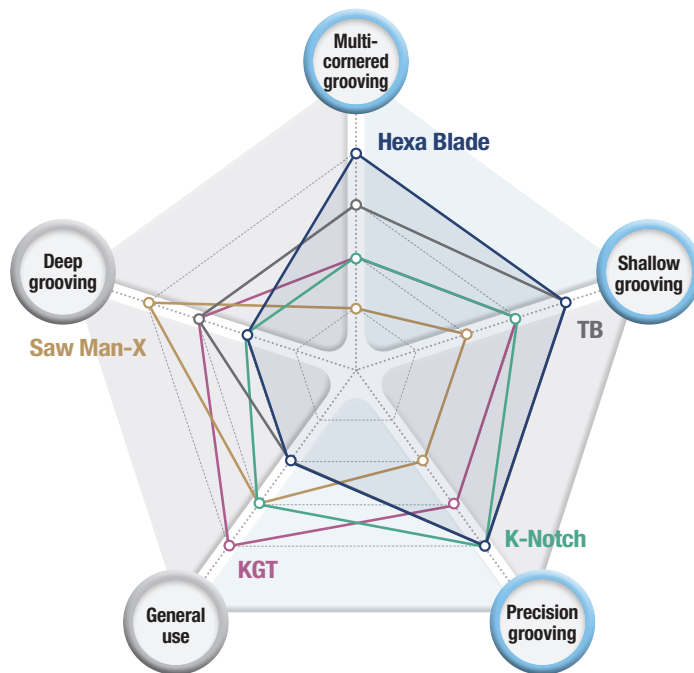

Hexa Blade ^{New}

- Precision typed and 6 cornered insert
- High economic efficiency and optimized for automated machining
- Precision grooving and multi-cornered grooving



TB

- Precision typed and 3 cornered insert
- Optimal for automatic cutting
- Precision grooving

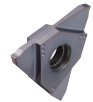

K-Notch

- Precision typed and 2 cornered insert
- Strong clamping system
- Precision grooving

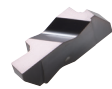

KGT

- 2 cornered insert
- Various applications
- For general use



Saw Man-X

- 1 cornered insert
- Optimal for interrupted and high feed parting
- Deep grooving



Tools	Multi-cornered grooving	Shallow grooving	Precision grooving	General use	Deep grooving
Hexa Blade ^{New}	★★★★★	★★★★★	★★★★★	★★	★★
TB	★★★	★★★★★	★★★★★	★★	★★★★
K-Notch	★★	★★★	★★★★★	★★★	★★
KGT	★★	★★★	★★★	★★★★★	★★★
Saw Man-X	★	★★	★★	★★★	★★★★★

 **Features**

Hexa Blade 19 (P chip breaker) 

- Universal chip breaker usable for various work materials
- Excellent cutting performance and superior surface finish achieved through sharp cutting edges

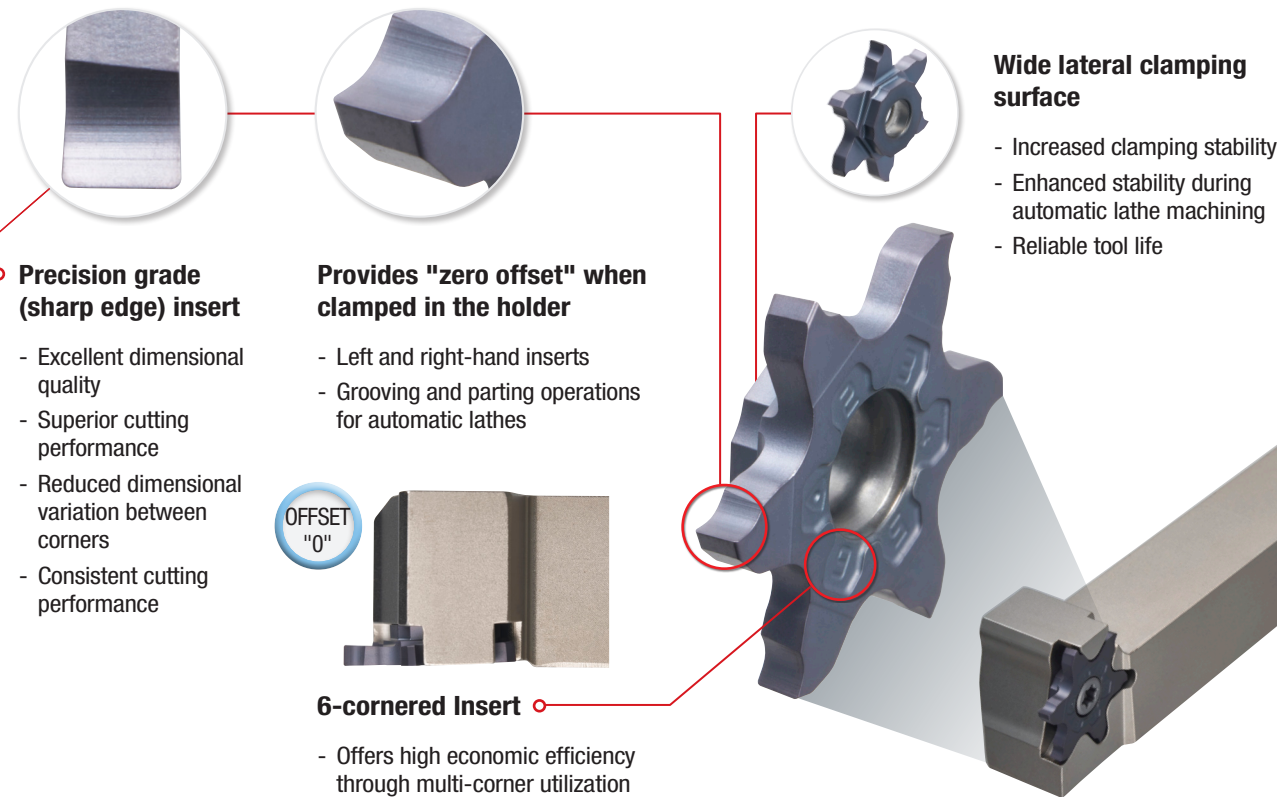

Precision grade (sharp edge) insert

- Excellent dimensional quality
- Superior cutting performance
- Reduced dimensional variation between corners
- Consistent cutting performance

Provides "zero offset" when clamped in the holder

- Left and right-hand inserts
- Grooving and parting operations for automatic lathes

Wide lateral clamping surface

- Increased clamping stability
- Enhanced stability during automatic lathe machining
- Reliable tool life

6-cornered Insert

- Offers high economic efficiency through multi-corner utilization

OFFSET "0"

Hexa Blade 27 (M chip breaker)

- Dot-typed chip breaker general cutting for various workpieces
- Good chip control preventing long chip and chip curling
- Stable cutting even in high feed cutting due to strengthened cutting edge structure

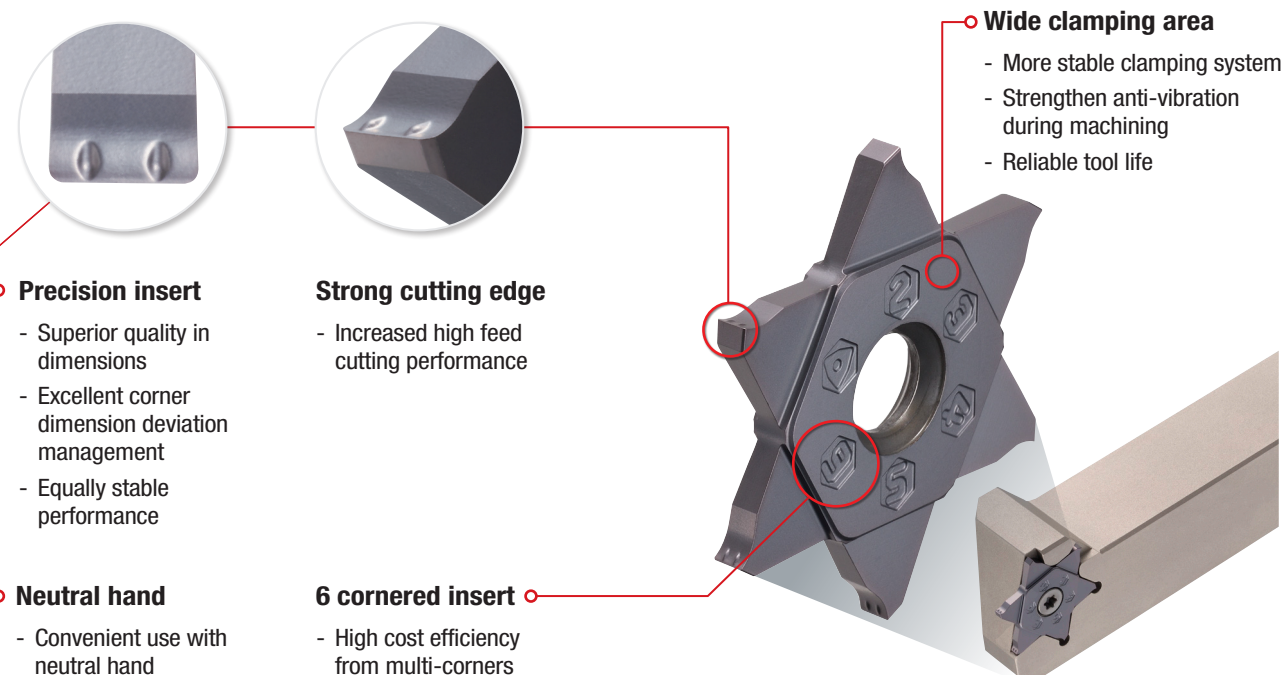

Precision insert

- Superior quality in dimensions
- Excellent corner dimension deviation management
- Equally stable performance

Strong cutting edge

- Increased high feed cutting performance

Wide clamping area

- More stable clamping system
- Strengthen anti-vibration during machining
- Reliable tool life

6 cornered insert

- High cost efficiency from multi-corners

Neutral hand

- Convenient use with neutral hand

Grade features

PC5300

- PVD coating layer with high hardness and oxidation resistance during machining at high temperature
→ Superior oxidation resistance during machining of steel, cast iron, stainless steel, and heat-resistance alloys
- Ultra fine grain substrate with high toughness and special treatment on the surface
→ Improved welding resistance and chipping resistance

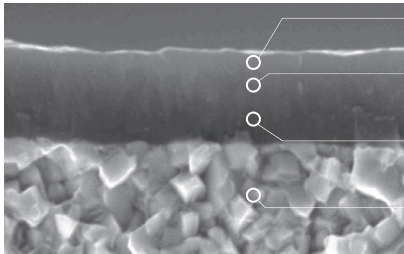

- Coating layer with high surface finish → Superior welding resistance
- Coating layer with high hardness and oxidation resistance during machining at high temperature → Superb wear resistance during machining at high speeds
- Coating layer with high toughness and high adhesive strength → Excellent chipping resistance
- Ultra fine grain substrate with high toughness → Great fracture resistance and stability in machining

- Special treatment on the surface
(Attached pictures if surface of coating layer)

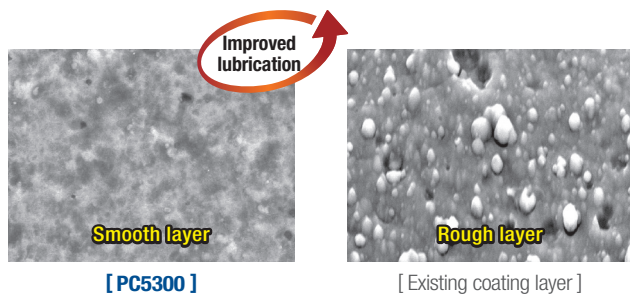

- Coating layer with oxidation resistance during machining at high temperature
(after 900° heat treatment)

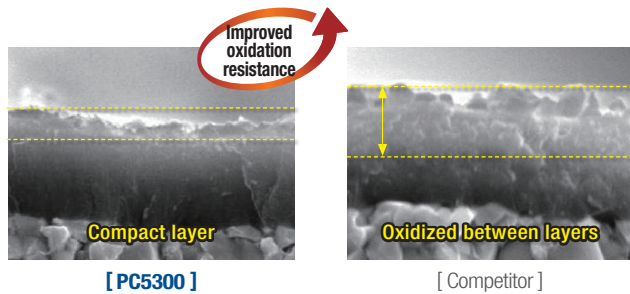

Application range

P Steel

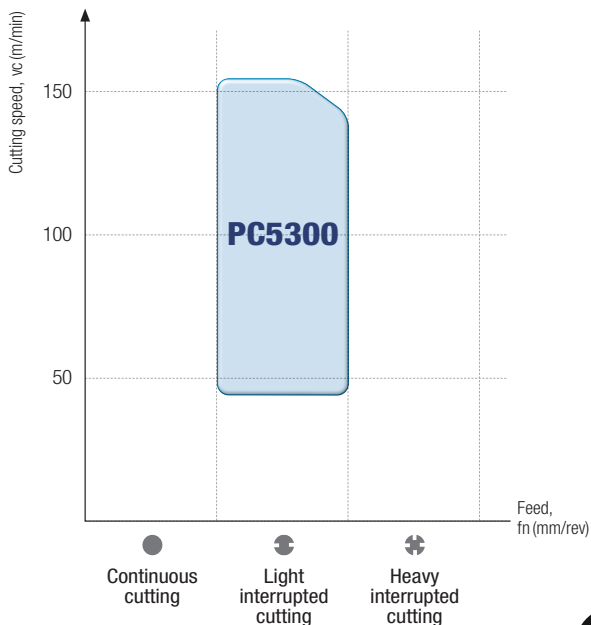

M Stainless steel

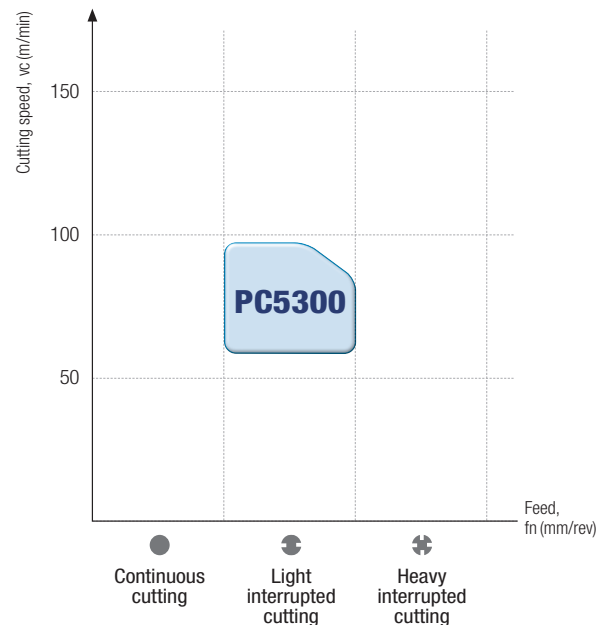

Recommended cutting conditions

* fn, ap : CW = Based on 2mm

ISO	Workpiece						PC5300	Hexa Blade 19		Hexa Blade 27				
	Workpiece material		ISO	AISI	Specific cutting force (N/mm ²)	Brinell hardness (HB)	vc (m/min)	fn (mm/rev)	ap (mm)	fn (mm/rev)	ap (mm)			
P	Carbon steel	C = 0.25~0.55%	C35	1035	1600	150	110	0.08	≤4	0.15	≤5			
							130	0.05		0.12				
							150	0.03		0.1				
		C = 0.55~0.80%	C45	1045 1046	1700	170	80	0.08		0.15				
							100	0.05		0.12				
							120	0.03		0.1				
	Low-alloy steel	Non-hardened	43CrMo4	4140	1700	180	80	0.08		0.15				
							100	0.05		0.12				
							120	0.03		0.1				
		Hardened and Tempered	-	4145	2050	350	50	0.08		0.15				
							60	0.05		0.12				
							70	0.03		0.1				
High-alloy steel	Annealed	-	D2	1950	200	60	0.08	0.15						
						75	0.05	0.12						
						90	0.03	0.1						
						M	Austenite series	X5CrNi18-9	304	2000	180	60	0.05	0.1
												80	0.04	0.08
												100	0.03	0.06
X5CrNiMo17-12-2	316	2000	180	60	0.05			0.1						
				80	0.04			0.08						
				100	0.03			0.06						

Recommended range

Hexa Blade 19 New

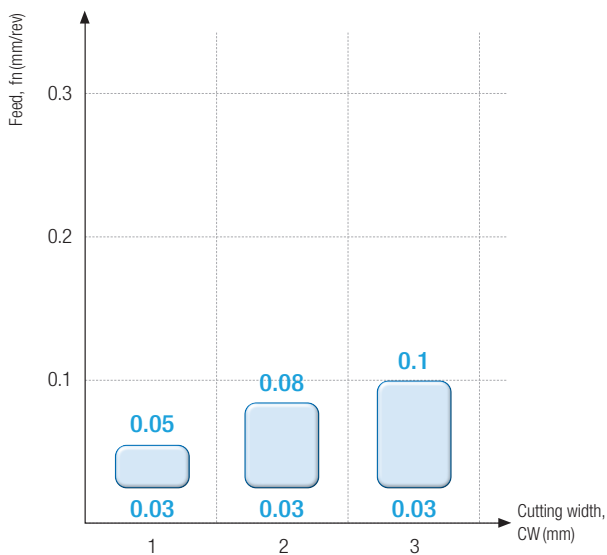

Hexa Blade 27

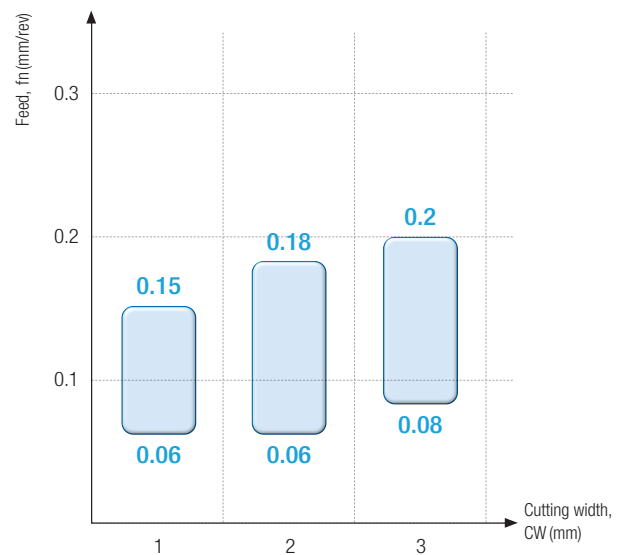

Performance evaluation

Wear resistance

Workpiece Alloy steel (SUSJ2)

Cutting condition $vc(m/min) = 25\sim75$ (RPM=4,000), $fn(mm/rev) = 0.08$, $ap(mm) = 3.0$, Wet

Tool **Insert** HB19R200-020-P (PC5300) **Holder** HBEHR1212-19

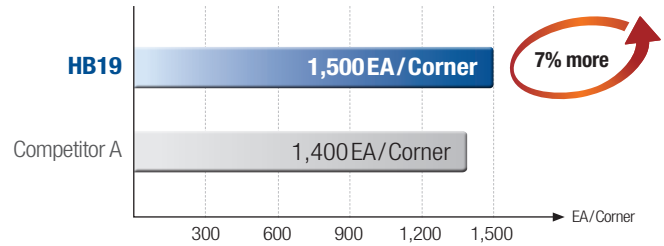
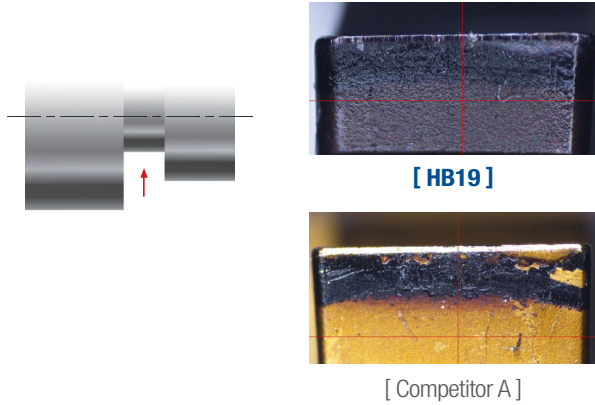

Wear resistance

Workpiece Stainless steel (STS316L)

Cutting condition $vc(m/min) = 25\sim75$ (RPM=4,000), $fn(mm/rev) = 0.08$, $ap(mm) = 3.0$, Wet

Tool **Insert** HB19R200-020-M (PC5300) **Holder** HBEHR2525-19

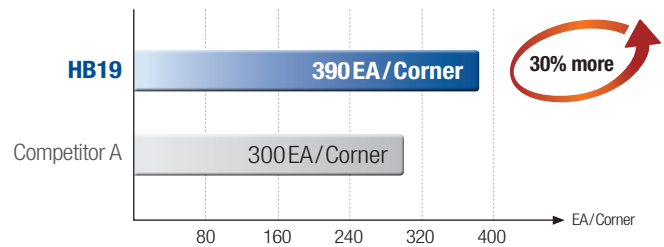
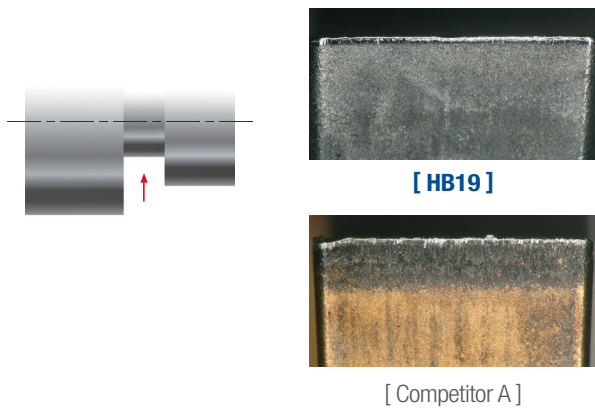

Performance evaluation

Grooving

Workpiece Alloy steel (SCM440)

Cutting condition $vc(m/min) = 100$, $fn(mm/rev) = 0.1$, $ap(mm) = 2.5$, Wet

Tool **Insert** HB27N200-020-M (PC5300) **Holder** HBEHR2525-27-2

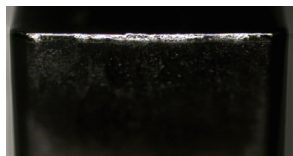
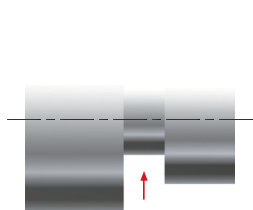

[HB27]

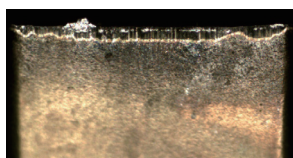

[Competitor B]

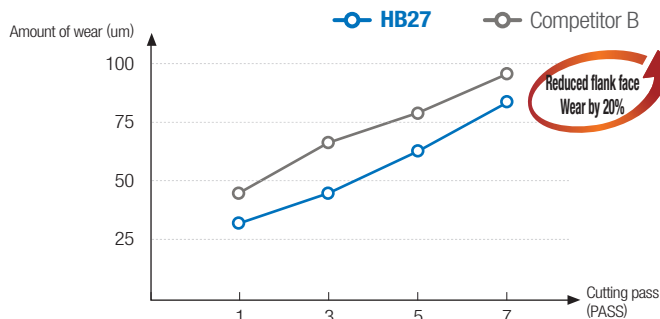

Grooving and Turning

Workpiece Carbon steel (SM10C)

Cutting condition $vc(m/min) = 120$, $fn(mm/rev) = 0.1$, $ap(mm) = 3$, Wet

Tool **Insert** HB27N300-040-M (PC5300) **Holder** HBEHR2525-27-3

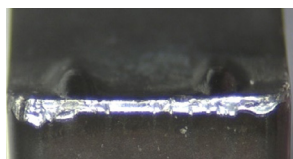
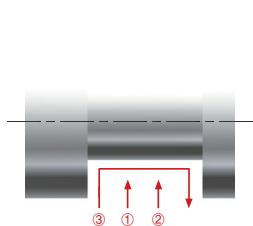

[HB27]

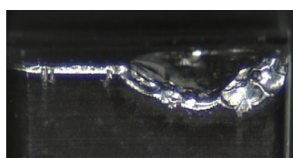

[Competitor C]

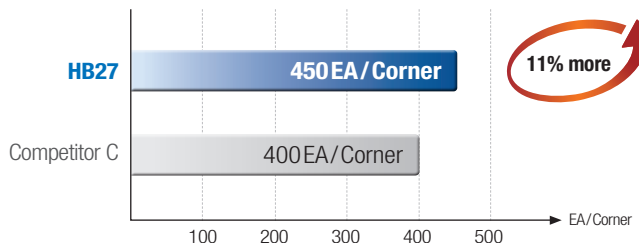

Grooving

Workpiece Alloy steel (SM20C)

Cutting condition $vc(m/min) = 172$, $fn(mm/rev) = 0.08$, $ap(mm) = 3$, Wet

Tool **Insert** HB27N196-015-M (PC5300) **Holder** HBEHR2525-27-2

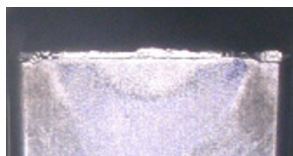
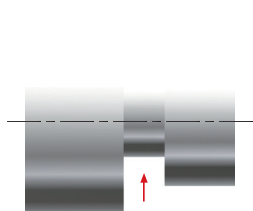

[HB27]



[Competitor D]

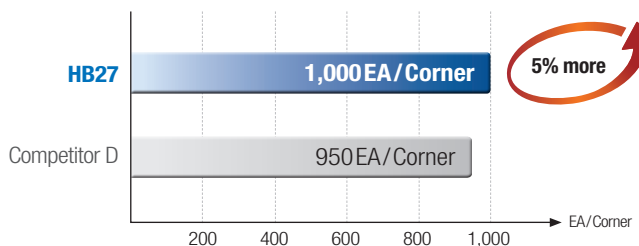

Product using guide

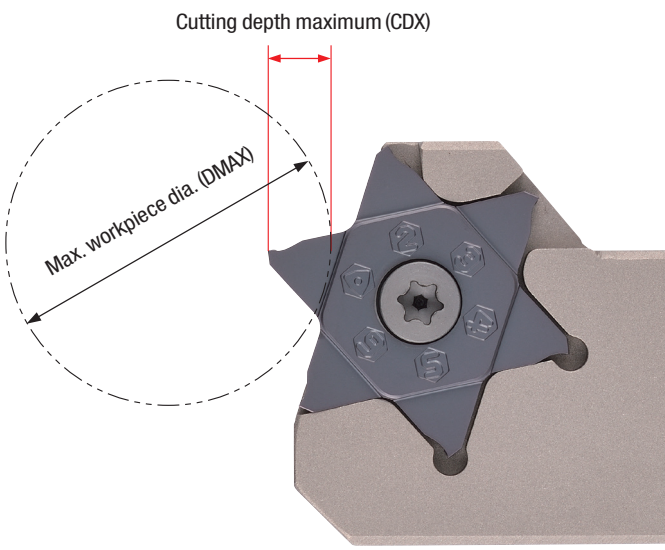
Cutting depth maximum and max. workpiece dia. (mm)						
Cutting depth maximum (CDX)	Max. workpiece dia. (DMAX)					Using guide
	Hexa Blade 19				Hexa Blade 27	
	CW ≤0.5	CW 0.6~0.8	CW 0.9~1.4	CW ≥1.5		
5.0	-	-	-	-	≤30	 <p>① Hexa Blade 19 offers a maximum cutting depth of 4.0mm. In this case, the maximum machinable workpiece diameter is 40mm.</p> <p>② When Hexa Blade 19 is used with a cutting depth of 2.4mm, it can be utilized regardless of the workpiece diameter. If the cutting depth exceeds this, the machinable workpiece diameter will vary according to the cutting depth.</p> <p>③ Hexa Blade 27 provides a maximum cutting depth of 5.0mm. At this depth, the maximum machinable workpiece diameter is 30mm.</p> <p>④ When Hexa Blade 27 is used with a cutting depth of 2.0mm, it can be utilized regardless of the workpiece diameter. If the cutting depth exceeds this, the machinable workpiece diameter will vary according to the cutting depth.</p> <p>⑤ If the workpiece diameter is 65mm, the maximum cutting depth for Hexa Blade 27 is 4.3mm. Machining with a greater cutting depth may cause contact between the workpiece and the holder, potentially leading to issues during operation.</p> <p>⑥ If the cutting depth is 3.5mm, the maximum machinable workpiece diameter with Hexa Blade 27 is 109mm. Machining workpieces with a diameter larger than this may cause contact between the workpiece and the holder, leading to potential operational problems.</p> <p>※ Cutting depth maximum and max. workpiece dia. on the chart could be different up to cutting environment.</p>
4.9	-	-	-	-	≤34	
4.8	-	-	-	-	≤38	
4.7	-	-	-	-	≤42	
4.6	-	-	-	-	≤46	
4.5	-	-	-	-	≤58	
4.4	-	-	-	-	≤62	
4.3	-	-	-	-	≤66	
4.2	-	-	-	-	≤70	
4.1	-	-	-	-	≤74	
4.0	-	-	-	≤40	≤89	
3.9	-	-	-	≤47	≤93	
3.8	-	-	-	≤50	≤97	
3.7	-	-	-	≤55	≤101	
3.6	-	-	-	≤58	≤105	
3.5	-	-	-	≤60	≤109	
3.4	-	-	-	≤65	≤123	
3.3	-	-	-	≤75	≤127	
3.2	-	-	-	≤82	≤131	
3.1	-	-	-	≤95	≤135	
3.0	-	-	≤40	≤105	≤147	
2.9	-	-	≤60	≤125	≤151	
2.8	-	-	≤100	≤150	≤155	
2.7	-	-	≤140	≤185	≤159	
2.6	-	-	≤170	≤200	≤163	
2.5	-	≤100	≤200	≤200	≤200	
2.4	-	∞	∞	∞	≤200	
2.3	-	∞	∞	∞	≤200	
2.2	-	∞	∞	∞	≤200	
2.1	-	∞	∞	∞	≤200	
2.0	∞	∞	∞	∞	∞	

Hexa Blade 19 **New**

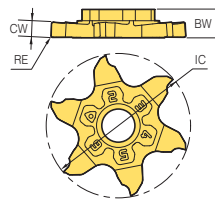
Picture	Designation	Coated	Dimension (mm)							Geometry
		PC5300	CW	RE	CDX	BW	IC	HAND		
	HB 19R050-000-P	○	0.5	0	2	3.75	19	R		
	19R075-000-P	○	0.75	0	2.5	3.75	19	R		
	19R080-000-P	○	0.8	0	2.5	3.75	19	R		
	19R080-040-P	○	0.8	0.4	2.5	3.75	19	R		
	19R095-000-P	○	0.95	0	3	3.75	19	R		
	19R100-010-P	○	1	0.1	3	3.75	19	R		
	19R100-050-P	○	1	0.5	3	3.75	19	R		
	19R120-010-P	○	1.2	0.1	3	3.75	19	R		
	19R140-010-P	○	1.4	0.1	3	3.75	19	R		
	19R150-010-P	○	1.5	0.1	4	3.75	19	R		
	19R157-010-P	○	1.57	0.1	4	3.75	19	R		
	19R157-079-P	○	1.57	0.79	4	3.75	19	R		
	19R170-010-P	○	1.7	0.1	4	3.75	19	R		
	19R175-010-P	○	1.75	0.1	4	3.75	19	R		
	19R196-010-P	●	1.96	0.1	4	3.75	19	R		
	19R200-010-P	●	2	0.1	4	3.75	19	R		
	19R200-020-P	●	2	0.2	4	3.75	19	R		
	19R200-100-P	●	2	1	4	3.75	19	R		
	19R222-010-P	●	2.22	0.1	4	3.75	19	R		
	19R230-010-P	●	2.3	0.1	4	3.75	19	R		
	19R239-010-P	●	2.39	0.1	4	3.75	19	R		
	19R239-120-P	●	2.39	1.2	4	3.75	19	R		
	19R247-010-P	●	2.47	0.1	4	3.75	19	R		
	19R250-010-P	●	2.5	0.1	4	3.75	19	R		
	19R250-020-P	●	2.5	0.2	4	3.75	19	R		
	19R270-010-P	●	2.7	0.1	4	3.75	19	R		
	19R287-010-P	●	2.87	0.1	4	3.75	19	R		
	19R300-010-P	●	3	0.1	4	3.75	19	R		
	19R300-020-P	●	3	0.2	4	3.75	19	R		
	19R300-150-P	●	3	1.5	4	3.75	19	R		
	19R318-010-P	●	3.18	0.1	4	3.75	19	R		

●: Stock item
○: Coming soon

HBEHR



HB19

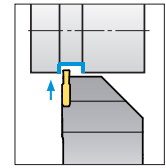
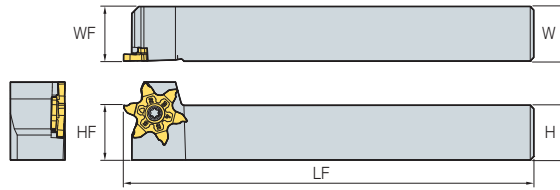

• R type holder

(mm)

Designation	Stock	CW	H	W	LF	HF	WF	Screw	Wrench
HBEHR 1212-19	●	0.75 ~ 3.18	12	12	120	12	12	PTMA0512D	TW15P
1616-19	●	0.75 ~ 3.18	16	16	120	16	16		

●: Stock item

HBEHR-KHP



HB19

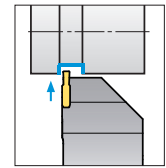
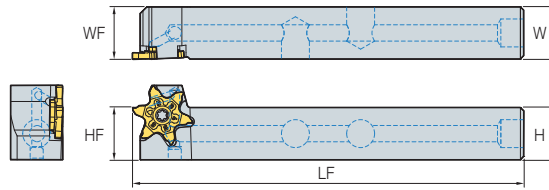

• R type holder

(mm)

Recommended pressure: 70 bar

Designation	Stock	CW	H	W	LF	HF	WF	Screw	Wrench	Plug
HBEHR 1212-19-KHP	●	0.75 ~ 3.18	12	12	120	12	12	PTMA0512D	TW15P HW50L	KHA0404-NYLOCK KHA516UNF-NYLOCK
1616-19-KHP	●	0.75 ~ 3.18	16	16	120	16	16	PTMA0512D	TW15P HW50L	KHA0404-NYLOCK KHA1075-W28

●: Stock item

HBEHR-KHPV



HB19

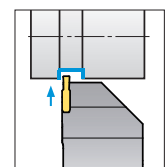
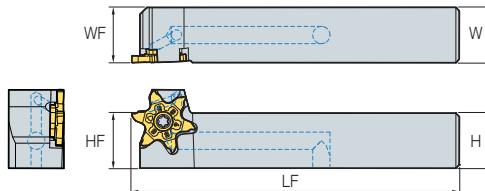

• R type holder

(mm)

Recommended pressure: 70 bar

Designation	Stock	CW	H	W	LF	HF	WF	Screw	Wrench	Plug
HBEHR 1616-19-KHPV	●	0.75 ~ 3.18	16	16	95	16	16	PTMA0512D	TW15P	KHA0404-NYLOCK KHA1075-W28

●: Stock item

Hexa Blade 27

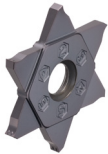
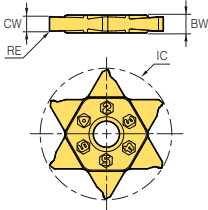
Picture	Designation	Coated	Dimension (mm)					Geometry
		PC5300	CW	RE	BW	IC	HAND	
	HB 27N178-018-M	●	1.78	0.18	2.7	27	N	
	27N185-015-M	●	1.85	0.15	2.7	27	N	
	27N196-015-M	●	1.96	0.15	2.7	27	N	
	27N200-020-M	●	2	0.2	2.7	27	N	
	27N200-040-M	●	2	0.4	2.7	27	N	
	27N270-010-M	●	2.7	0.1	3.7	27	N	
	27N287-020-M	●	2.87	0.2	3.7	27	N	
	27N300-000-M	●	3	0	3.7	27	N	
	27N300-020-M	●	3	0.2	3.7	27	N	
	27N300-040-M	●	3	0.4	3.7	27	N	
	27N374-020-M	●	3.74	0.2	4.7	27	N	
	27N398-020-M	●	3.98	0.2	4.7	27	N	
	27N400-040-M	●	4	0.4	4.7	27	N	

●: Stock item

HBEHR/L

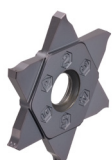

HB27

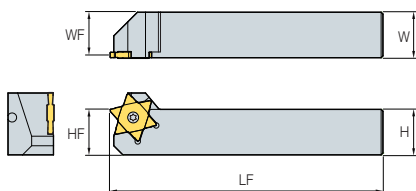

Fig. 1

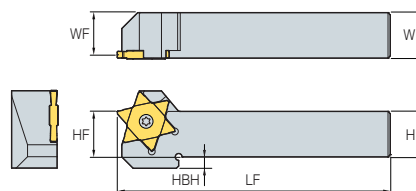
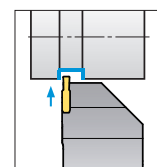

Fig. 2



• R type holder

(mm)

Designation	Stock		CW	H	W	LF	HF	WF	HBH	Screw	Wrench	Fig.
	R	L										
HBEHR/L 1616-27-2	●		1.78 ~ 2	16	16	100	16	15	9	PTMA0512D	TW15P	2
1616-27-3	●		2.7 ~ 3	16	16	100	16	14.5	9			2
1616-27-4	●		3.74 ~ 4	16	16	100	16	14	9			2
2020-27-2	●		1.78 ~ 2	20	20	120	20	19	5			2
2020-27-3	●		2.7 ~ 3	20	20	120	20	18.5	5			2
2020-27-4	●		3.74 ~ 4	20	20	120	20	18	5			2
2525-27-2	●		1.78 ~ 2	25	25	150	25	24	-			1
2525-27-3	●		2.7 ~ 3	25	25	150	25	23.5	-			1
2525-27-4	●		3.74 ~ 4	25	25	150	25	23	-			1

●: Stock item



HBEHR/L-KHP

Recommended pressure: 70 bar 

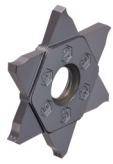

HB27

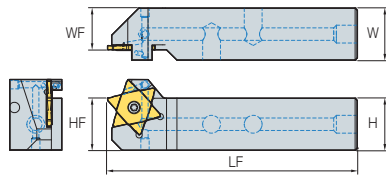

Fig. 1

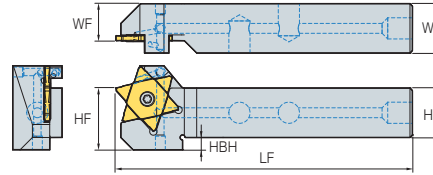
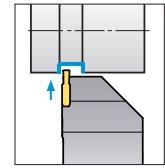

Fig. 2



• R type holder

(mm)

Designation	Stock		CW	H	W	LF	HF	WF	HBH	Screw	Wrench	Plug	Fig.
	R	L											
HBEHR/L 2020-27-2-KHP			1.78 ~ 2	20	20	120	20	14	5	PTMA0512D	TW15P HW50L	KHA0404-NYLOCK KHA1075-W28	2
2020-27-3-KHP			2.7 ~ 3	20	20	120	20	14	5				2
2020-27-4-KHP			3.74 ~ 4	20	20	120	20	14	5				2
2525-27-2-KHP			1.78 ~ 2	25	25	120	25	19	-				1
2525-27-3-KHP			2.7 ~ 3	25	25	120	25	19	-				1
2525-27-4-KHP			3.74 ~ 4	25	25	120	25	19	-				1

●: Stock item

HBEHR/L-KHPV

Recommended pressure: 70 bar 

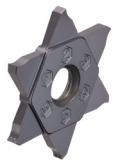

HB27

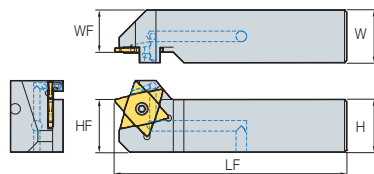

Fig. 1

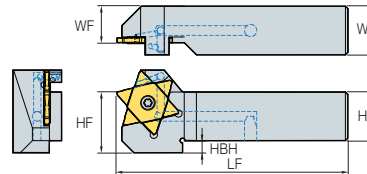
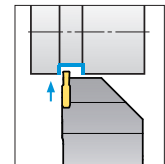

Fig. 2









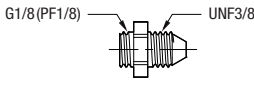

• R type holder

(mm)

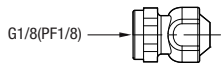

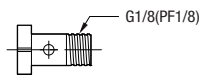
Designation	Stock		CW	H	W	LF	HF	WF	Screw	Wrench	Plug	Fig.
	R	L										
HBEHR/L 2020-27-2-KHPV			1.78 ~ 2	20	20	95	20	14	PTMA0512D	TW15P	KHA0404-NYLOCK KHA1075-W28	2
2020-27-3-KHPV			2.7 ~ 3	20	20	95	20	14				2
2020-27-4-KHPV			3.74 ~ 4	20	20	95	20	14				2
2525-27-2-KHPV			1.78 ~ 2	25	25	95	25	19				1
2525-27-3-KHPV			2.7 ~ 3	25	25	95	25	19				1
2525-27-4-KHPV			3.74 ~ 4	25	25	95	25	19				1

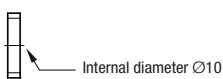
●: Stock item

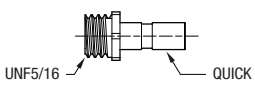
Connecting parts

Parts	Designation	Shape of parts	
Adaptor	HPA3/8UNF1/8PF		
Blank	HPB1/8PF		
Banjo screw	HPZ1/8PF		
Copper washer	HPW1/8PF		
Quick adaptor	HPAQ5/16UNF		

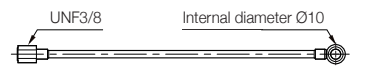
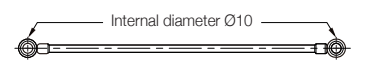
High pressure hose

The shape of the high pressure hose		Length	Standard S	Standard B	Standard Q
Straight to straight (HPH3/8UNF)	S  S	200mm	UNF3/8	-	-
		250mm			
Straight to banjo (HPH3/8UNF1/8PF)	S  B	200mm	UNF3/8	Internal diameter Ø10	-
		250mm			
Banjo to banjo (HPH1/8PF)	B  B	200mm	-	Internal diameter Ø10	-
		250mm			
Quick straight (HPHZ5/16UNF3/8UNF-500)	Q  S	500mm	-	-	UNF5/16

Notice

- Use a proper spanner for clamping up to the specs.
- Be careful of coolant injection by the residual pressure while using high pressure coolant.
- Clamp the parts completely before usage.
- Clean the turning machine before clamping.
- The O-ring is included in the parts. Don't have to purchase it separately.

⚠ For the safe metalcutting

- Use safety supplies such as protective gloves to prevent possible injury while touching the edge of tools.
- Use safety glasses or safety cover to hedge possible dangers. Inappropriate usage or excessive cutting condition may lead tool's breakage or even the fragment's scattering.
- Clamp the workpiece tightly enough to prevent its movement while its machining.
- Properly manage the tool change phase because the inordinately used tool can be easily broken under the excessive cutting load or severe wear, and it may threat the operator's safety.
- Use safety cover because chips evacuated during cutting are hot and sharp and may cause burns and cuts. To remove chips safely, stop machining, put on protective gloves, and use a hook or other tools.
- Prepare for fire prevention measures as the use of the non-water soluble cutting oil may cause fire.
- Use safety cover and other safety supplies because the spare parts or the tools can be pulled out due to centrifugal force while high speed machining.



Head Office: Holystar B/D, 326, Seocho-daero, Seocho-gu, Seoul, 06633, Republic of Korea
Tel: +82-2-522-3181 Fax: +82-2-522-3184, +82-2-3474-4744 Web: www.korloy.com E-mail: sales.khq@korloy.com

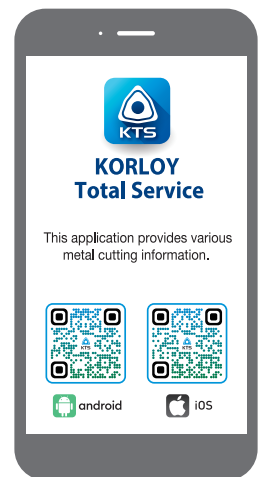

KORLOY AMERICA

620 Maple Avenue, Torrance, CA 90503, USA
Tel : +1-310-782-3800 / +1-888-711-0001 Fax : +1-310-782-3885
E-mail : sales.kai@korloy.com

KORLOY INDIA

Plot No. 415, Sector 8, IMT Manesar, Gurgaon 122051, Haryana, India
Tel : +91-124-4391790 Fax : +91-124-4050032
E-mail : sales.kip@korloy.com

KORLOY TURKIYE

Ziya Gokalp, Mah. Seyit Onbasi Cad. No:36, 3 Kat,
iC Kapi No : 5 Basaksehir/Istanbul, Turkiye
Tel : +90-212-813-8874 E-mail : sales.ktl@korloy.com

KORLOY RUSSIA

115280, Moscow, vn.ter.g. municipal district Danilovsky,
street Masterkova, house 4, premises 1/2
Tel : +7-495-280-1458 Fax : +7-495-280-1459 E-mail : sales.krc@korloy.com

KORLOY UK

13 Approach Rd, Raynes Park, London SW20 8BA, United Kingdom
E-mail : sales.kul@korloy.com

KORLOY EUROPE

Gablonzer Str. 25-27, 61440 Oberursel, Germany
Tel : +49-6171-27783-0 Fax : +49-6171-27783-59
E-mail : sales.keg@korloy.com

KORLOY BRASIL

Av. Aruana 280, conj.12, WLC, Alphaville, Barueri, CEP06460-010, SP, Brasil
Tel : +55-11-4193-3810 Fax : +55-11-4193-5837
E-mail : sales.kbl@korloy.com

KORLOY CHILE

Av. Providencia 1650, Office 1009, 7500027
Providencia-Santiago, Chile
Tel : +56-229-295-490 E-mail : sales.kcs@korloy.com

KORLOY MEXICO

Avenida de las Ciencias, No. 3015, Interior 406, Juriquilla Santa Fe,
C.P.76230 Querétaro, Mexico
Tel : +52-442-193-3600 E-mail : sales.kml@korloy.com

KORLOY FACTORY INDIA

Plot NO. 415, Sector 8, IMT Manesar, Gurgaon 122051, Haryana, India
Tel : +91-124-4391790 Fax : +91-124-4050032
E-mail : pro.kim@korloy.com

